

# Stormwater Management Manual for Eastern Washington



August 2019



DEPARTMENT OF  
**ECOLOGY**  
State of Washington

Publication Number 18-10-044



*Printed on recycled paper*

*This page has been intentionally left blank for double-sided printing.*



# **Stormwater Management Manual for Eastern Washington**

---

**Chapter 1 - Introduction**

**Chapter 2 - Core Elements for New Development and Redevelopment**

**Chapter 3 - Preparation of Stormwater Site Plans**

**Chapter 4 - Hydrologic Analysis and Design**

**Chapter 5 - Runoff Treatment BMP Design**

**Chapter 6 - Flow Control BMP Design**

**Chapter 7 - Construction Stormwater Pollution Prevention**

**Chapter 8 - Source Control**

Prepared by:

Washington State Department of Ecology  
Water Quality Program

August 2019  
Publication Number 18-10-044

*This page has been intentionally left blank for double-sided printing.*

## ***Accommodation Requests***

To request ADA accommodation including materials in a format for the visually impaired, call Ecology at 360-407-6457 or visit <https://ecology.wa.gov/accessibility>. People with impaired hearing may call Washington Relay Service at 711. People with speech disability may call TTY at 877-833-6341.

*This page has been intentionally left blank for double-sided printing.*

# Executive Summary of the 2019 Revisions

The *Stormwater Management Manual for Eastern Washington* (SWMMEW) provides guidance for the measures necessary to control the quantity and quality of stormwater in eastern Washington. Local jurisdictions use this manual to set stormwater requirements for new development and redevelopment projects. Land developers and designers use this manual to design permanent stormwater control plans, develop construction stormwater pollution prevention plans, and determine stormwater infrastructure. Businesses use this manual to help design their stormwater pollution prevention plans.

## 2019 Stormwater Management Manual for Eastern Washington Revisions

Ecology originally published the *Stormwater Management Manual for Eastern Washington* (SWMMEW) in September 2004. In February 2019, Ecology published the first major update to the SWMMEW in 15 years.

The February 2019 SWMMEW has incorporated the following major revisions:

- Clarified and updated guidance related to the Underground Injection Control (UIC) program ([1.4.6 Underground Injection Control Program](#) and [5.6 Subsurface Infiltration \(Underground Injection Control Wells\)](#))
- New section on Washington State Department of Agriculture pesticide regulations ([1.4.12 WSDA Pesticide Regulations](#))
- New section on stormwater discharges to public sanitary sewers, septic systems, dead-end sumps, and industrial waste treatment systems ([1.4.13 Stormwater Discharges to Public Sanitary Sewers, Septic Systems, Dead-End Sumps, and Industrial Waste Treatment Systems](#))
- New flow charts to clarify new development and redevelopment requirements ([2.5 New Development](#) and [2.6 Redevelopment](#))
- New appendix discussing site planning principles and design strategies ([Appendix 3-D: Additional Guidance on Low Impact Development Site Planning Principles and Design Strategies](#))
- Updated Best Management Practices (BMPs) template ([Chapter 5 - Runoff Treatment BMP Design](#) and [Chapter 6 - Flow Control BMP Design](#))
- Updated Site Suitability Criteria ([5.4.3 General Criteria for Infiltration and Bioinfiltration BMPs](#))
- New runoff treatment BMPs from the *Eastern Washington Low Impact Development Guidance Manual* and the Washington State Department of Transportation *Highway Runoff Manual* (WSDOT HRM) ([5.4.7 BMPs for Surface Infiltration and Bioinfiltration](#), [5.5.5 BMPs for Bioinfiltration](#), and [5.8.5 BMPs for Sand Filtration](#))
- Consolidated and updated planting recommendations ([Appendix 5-B: Planting](#))

## [Recommendations](#))

- New flow control BMPs from the *Eastern Washington Low Impact Development Guidance Manual* ([6.2.5 BMPs for Detention](#), [6.3.6 BMPs for Infiltration](#), and [6.6.5 Additional BMPs for Flow Control](#))
- Updated guidelines for determining infiltration rates ([6.3.3 General Criteria for Infiltration BMPs](#) and [Appendix 6-B: Guidelines for Site Characterization of Geotechnical Properties](#))
- Updated design guidance from the WSDOT HRM for dispersion BMPs ([6.5 Dispersion BMPs](#))
- New construction BMPs ([7.3 Standards and Specifications for Best Management Practices](#))
- New source control BMPs ([8.2 Selection of Operational and Structural Source Control BMPs](#))
- Updated definitions for consistency with the Phase II Municipal Stormwater National Pollutant Discharge Elimination System Permit for eastern Washington (Municipal Stormwater Permit) ([Glossary](#))
- Updated references ([References](#))

After publication of the February 2019 SWMMEW, Ecology was still receiving public comments for the *Stormwater Management Manual for Western Washington* (SWMMWW). As a result of the comments received on the 2019 SWMMWW, Ecology made the following additional revisions to the 2019 SWMMEW to make it consistent with state-wide requirements. Ecology then republished the February 2019 SWMMEW as the August 2019 SWMMEW.

- Updated [5.6 Subsurface Infiltration \(Underground Injection Control Wells\)](#) due to corrections made in response to comments received during the SWMMWW comment period.
- Updated [6.3.3 General Criteria for Infiltration BMPs](#) to include the equation/explanation to calculate the Total Correction Factor (CFT).
- Updated [BMP C151E: Concrete Handling](#) and [BMP C154E: Concrete Washout Area](#) due to corrections made in response to comments received during the SWMMWW comment period. The corrections are regarding the guidance for washing out concrete trucks on site. These corrections provide consistency between the manual and the state-wide Construction Stormwater General Permit.
- Updated [Appendix 8-B: Management of Street Waste Solids and Liquids](#) due to revisions to WAC 173-350 that apply state-wide.
- Updated [S440E: BMPs for Pet Waste](#) due to corrections made in response to comments received during the SWMMWW comment period. The corrections are primarily regarding the guidance for burying and composting pet waste, as well as the applicability of the BMPs.
- Updated [S452E: BMPs for Goose Waste](#) due to corrections made in response to comments received during the SWMMWW comment period. The corrections are primarily regarding the applicability of the BMPs.
- Minor revisions to correct typographical errors.



## ***How to Find the 2019 Stormwater Management Manual for Eastern Washington on the Internet***

The 2019 *Stormwater Management Manual for Eastern Washington* is available on the Washington State Department of Ecology's (Ecology's) Stormwater Management Manual web page at the following web address:

<https://ecology.wa.gov/Regulations-Permits/Guidance-technical-assistance/Stormwater-permittee-guidance-resources/Stormwater-manuals>

## ***How to Find Corrections, Updates, and Additional Information***

With a publication of this size and complexity, there will inevitably be errors that must be corrected and clarifications that will be needed. There will also be new information and technological updates. Ecology intends to publish corrections, updates, and new technical information with the interactive online version of the 2019 SWMMEW. Ecology will not use the interactive online version to make revisions in key policy areas—such as the thresholds and Core Elements in [Chapter 2 - Core Elements for New Development and Redevelopment](#). Please check the interactive online version periodically for corrections and updates.

## ***Public Involvement for the 2019 Stormwater Management Manual for Eastern Washington***

Ecology worked closely with a steering committee composed of representatives from cities and counties and secondary permittees in eastern Washington covered by a Phase II Municipal Stormwater National Pollutant Discharge Elimination System Permit (see [Acknowledgments](#) for a full list of the 2019 manual steering committee members) and a consultant team (Herrera Environmental Consultants, Inc.; Robin Kirschbaum, Inc.; AHBL, Inc.; GeoEngineers, Inc.; CMS Writing and Editing Services; and MadSkills) to develop the revisions that have been incorporated into the 2019 manual.

Ecology provided public involvement opportunities and received public comments in preparation of the 2019 manual by means of the following:

- Project webinar on June 27, 2017
- Informal public comment period on the 2004 *Stormwater Management Manual for Eastern Washington* (June through September 2017)
- Public meeting related to the public review draft of the 2019 manual in Spokane on June 12, 2018
- Public meeting related to the public review draft of the 2019 manual in Richland on June 26, 2018
- Public webinar related to the public review draft of the 2019 manual on July 10, 2018
- Formal public comment period on the public review draft of the 2019 manual (May through July 2018)

*This page has been intentionally left blank for double-sided printing.*

## **Acknowledgments**

Ecology would like to thank the members of the 2019 manual steering committee for their valuable commitment of time and leadership in leading the process of updating this manual. Ecology would also like to recognize Ecology staff who participated in the review and update process for the 2019 manual.

### ***2019 SWMMEW Steering Committee***

Adrienne Pearson, City of Spokane

Alex Nguyen, Washington State Department of Transportation

Art Jenkins, City of Spokane Valley

Bill Aukett, City of Moses Lake

Brad Daly, City of Walla Walla

Chad Phillips, City of Spokane Valley

Colleen Little, Spokane County; Steering Committee Chair

Danielle Mullins, City of West Richland; Steering Committee Chair

David Haws, Yakima County

Dean Smith, Department of Corrections

Heather Killinger, Grant County Conservation District

Jennifer Lange, Douglas County

Jon Morrow, City of Ellensburg

Mark Melton, City of Richland

Mark Papich, City of Spokane

Ruby Irving-Hewey, City of Yakima

Seth Walker, Walla Walla County

Shilo Sprouse, City of Pullman

Tom Wachholder, City of East Wenatchee

Tony Garcia, Walla Walla County

### ***2019 SWMMEW Ecology Reviewers***

Abbey Stockwell

Amanda Heye

Amy Moon

Bill Moore  
Brandy Reynecke  
Coleman Miller  
Dave Duncan  
Doug Howie  
Mary Shaleen-Hanson  
Ray Latham  
Shannon Petrisor  
Travis Porter  
Vince McGowan

### ***Cover Photos***

Cover, clockwise from bottom:

- A bioretention swale treats runoff alongside a meandering walking path in Spokane. Photo provided by Ecology staff.
- A pervious concrete roadway is ready for rainfall in Spokane. Photo provided by Ecology staff.
- An armoured stormwater outfall overlooks Lake Roosevelt in Lincoln County. Photo provided by Ecology staff.
- The Spokane Valley/WSDOT decant facility awaits the next load. Photo provided by Ecology staff.
- A bioretention cell boasts its beauty in Walla Walla. Photo provided by Ecology staff.
- A street sweeper poses with an elevated debris tank at the Port of Vancouver. Photo provided by Matt Graves, Port of Vancouver.

Spine, top to bottom:

- A bioinfiltration area blends into the landscape at a park in Spokane. Photo provided by Ecology staff.
- Emergency overflows into a biofiltration swale are provided along an experimental porous asphalt pavement roadway project in Spokane. Photo provided by Ecology staff.
- A TAPE approved emerging stormwater treatment technology structure treats stormwater upstream of an infiltration basin in Union Gap. Photo provided by Ecology staff.

# Table of Contents

---

<b>Executive Summary of the 2019 Revisions</b> .....	<b>7</b>
<b>Acknowledgments</b> .....	<b>11</b>
<b>Table of Contents</b> .....	<b>13</b>
List of Tables .....	30
List of Figures .....	36
<b>Chapter 1 - Introduction</b> .....	<b>43</b>
1.1 Purpose and Scope .....	43
1.1.1 Objective .....	43
1.1.2 The Manual's Role as Technical Guidance .....	44
1.1.3 More Stringent Measures and Retrofitting .....	44
1.1.4 Presumptive Versus Demonstrative Approaches to Protecting Water Quality .....	45
1.1.5 Comparison of the Stormwater Management Manuals for Eastern and Western Washington .....	47
1.2 How to Use This Manual .....	48
1.2.1 Applications of This Manual .....	48
1.2.2 Organization of This Manual .....	48
1.2.3 Stormwater Technical Manual .....	49
1.2.4 Alternative Technical Manuals .....	50
1.3 Effects of Urbanization .....	50
1.3.1 Introduction to the Effects of Urbanization .....	50
1.3.2 Water Quality Changes .....	50
1.3.3 Hydrologic Changes .....	52
1.4 Relationship of This Manual to Federal, State, and Local Regulatory Requirements .....	55
1.4.1 Introduction to the Relationship of This Manual to Federal, State, and Local Regulatory Requirements .....	55
1.4.2 Applicable Federal and State Regulations .....	56
1.4.3 NPDES and State Waste Discharge Stormwater Permits for Municipalities .....	56

---

1.4.4 Industrial Stormwater General Permit .....	57
1.4.5 Construction Stormwater General Permit .....	58
1.4.6 Underground Injection Control Program .....	58
1.4.7 Endangered Species Act .....	59
1.4.8 Section 401 Water Quality Certifications and Section 404 Permits .....	60
1.4.9 Hydraulic Project Approvals .....	60
1.4.10 Aquatic Lands Use Authorizations .....	60
1.4.11 Requirements Identified Through Watershed/Basin Planning or Total Maximum Daily Loads .....	61
1.4.12 WSDA Pesticide Regulations .....	61
1.4.13 Stormwater Discharges to Public Sanitary Sewers, Septic Systems, Dead-End Sumps, and Industrial Waste Treatment Systems .....	62
1.4.14 Other Local Jurisdiction Requirements .....	63
1.4.15 Local Jurisdiction Role in Implementing State/Federal Permit Requirements and Programs .....	64
1.5 Development Of Best Management Practices for Stormwater Management .....	64
1.5.1 Best Management Practices .....	64
1.5.2 Source Control BMPs .....	64
1.5.3 Runoff Treatment BMPs .....	65
1.5.4 Flow Control BMPs .....	65
1.5.5 Construction Stormwater BMPs .....	66
1.5.6 New and Emerging BMPs .....	66
<b>Chapter 2 - Core Elements for New Development and Redevelopment .....</b>	<b>67</b>
2.1 Introduction .....	67
2.2 Exemptions .....	68
2.3 Partial Exemptions .....	69
2.4 Local Exceptions/Variations .....	70
2.5 New Development .....	71
2.6 Redevelopment .....	74

---

2.7 Core Elements .....	80
2.7.1 Introduction to the Core Elements .....	80
2.7.2 Core Element #1: Preparation of a Stormwater Site Plan .....	81
2.7.3 Core Element #2: Construction Stormwater Pollution Prevention .....	81
2.7.4 Core Element #3: Source Control of Pollution .....	83
2.7.5 Core Element #4: Preservation of Natural Drainage Systems .....	84
2.7.6 Core Element #5: Runoff Treatment .....	86
2.7.7 Core Element #6: Flow Control .....	97
2.7.8 Core Element #7: Operation and Maintenance .....	104
2.7.9 Core Element #8: Local Requirements .....	105
<b>Chapter 3 - Preparation of Stormwater Site Plans .....</b>	<b>109</b>
3.1 Introduction .....	109
3.2 Stormwater Site Plans: Step by Step .....	109
3.2.1 Introduction .....	109
3.2.2 Step 1: Site Analysis: Collect and Analyze Information on Existing Conditions .....	110
3.2.3 Step 2: Prepare Preliminary Development Layout .....	110
3.2.4 Step 3: Perform Off-Site Analysis .....	111
3.2.5 Step 4: Determine Applicable Core Elements .....	111
3.2.6 Step 5: Prepare a Permanent Stormwater Control Plan .....	111
3.2.7 Step 6: Select Construction Stormwater Pollution Prevention BMPs .....	113
3.2.8 Step 7: Complete the Stormwater Site Plan .....	115
3.2.9 Step 8: Check Compliance With All Applicable Core Elements .....	116
3.3 Plans Required After Stormwater Site Plan Approval .....	116
3.3.1 Introduction .....	116
3.3.2 Stormwater Site Plan Changes .....	117
3.3.3 Record Drawings .....	117
Appendix 3-A: Off-Site Analysis .....	119
Appendix 3-B: Basin Maps .....	123

---

Appendix 3-C: Stormwater Construction Plans .....	125
Appendix 3-D: Additional Guidance on Low Impact Development Site Planning Principles and Design Strategies .....	127
3.D.1 Introduction .....	127
3.D.2 LID Site Planning .....	127
3.D.3 Designing for LID .....	141
<b>Chapter 4 - Hydrologic Analysis and Design .....</b>	<b>169</b>
4.1 Introduction .....	169
4.2 Hydrologic Analysis Methods and Applicability .....	171
4.2.1 Introduction .....	171
4.2.2 Hydrologic Analysis for Core Element #5: Runoff Treatment .....	173
4.2.3 Hydrologic Analysis for Core Element #6: Flow Control .....	173
4.3 Design Storm Distributions .....	173
4.3.1 Climate Regions .....	173
4.3.2 Distributions and Applicability .....	176
4.3.3 Short-Duration and Regional Design Storms .....	179
4.3.4 SCS Type IA and Type II Standard Design Storms .....	184
4.3.5 Modified SCS Type IA and Regional Design Storms .....	187
4.3.6 Precipitation Magnitude/Frequency Analysis .....	188
4.3.7 Precipitation Magnitude and Frequency for 24-Hour and Regional Storms .....	190
4.3.8 Precipitation Magnitude and Frequency for Short-Duration Storms .....	192
4.3.9 Rain-on-Snow and Snowmelt Design .....	194
4.4 Precipitation Maps .....	204
4.5 Single-Event Hydrograph Methods .....	209
4.5.1 Introduction .....	209
4.5.2 Hydrograph Design Process .....	209
4.5.3 Travel Time and Time of Concentration .....	212
4.5.4 Hydrograph Synthesis .....	220



---

4.6 SCS Curve Number Equations .....	221
4.6.1 Introduction .....	221
4.6.2 Area .....	221
4.6.3 Curve Number .....	222
4.7 Level-Pool Routing Method .....	231
4.8 Rational Method .....	232
4.8.1 Introduction .....	232
4.8.2 Time of Concentration for Rational Method .....	235
Appendix 4-A: Background Information on Design Storms and Selected Modeling Methods	239
4.A.1 Introduction .....	239
4.A.2 Development of Short- and Long-Duration Design Storms for Eastern Washington	239
4.A.3 Review of Design Storms and Identification of Best Rainfall-Runoff Modeling Approaches for Eastern Washington .....	251
Appendix 4-B: Historical Storms Used to Develop Design Storms in Eastern Washington ..	257
4.B.1 Long-Duration General Storms .....	257
4.B.2 Short-Duration General Storms .....	260
Appendix 4-C: Long-Duration Storm Hyetographs for Eastern Washington .....	263
4.C.1 Introduction .....	263
4.C.2 Long-Duration Design Storm Figures .....	264
4.C.3 Climate Region 1: Cascade Mountains .....	268
4.C.4 Climate Region 2: Central Basin .....	270
4.C.5 Climate Region 3: Okanogan, Spokane, Palouse .....	273
4.C.6 Climate Region 4: Eastern Mountains .....	276
Appendix 4-D: Design Storm Hyetographs .....	281
4.D.1 Introduction .....	281
4.D.2 SCS Type IA Storm Hyetograph Values .....	281
4.D.3 SCS Type II Storm Hyetograph Values .....	285
4.D.4 Short-Duration Storm Hyetograph Values for All Climate Regions .....	289

---

4.D.5 Climate Region 1: Cascade Mountains .....	290
4.D.6 Climate Region 2: Central Basin .....	292
4.D.7 Climate Region 3: Okanogan, Spokane, Palouse .....	293
4.D.8 Climate Region 4: Eastern Mountains .....	295
Appendix 4-E: Example SBUH Runoff Hydrograph .....	297
<b>Chapter 5 - Runoff Treatment BMP Design .....</b>	<b>303</b>
5.1 Introduction to Runoff Treatment BMP Design .....	303
5.1.1 Introduction .....	303
5.1.2 How to Use This Chapter .....	303
5.1.3 Runoff Treatment Methods and BMPs .....	303
5.1.4 Performance Goals and BMP Options .....	304
5.2 Runoff Treatment BMP Selection Process .....	307
5.2.1 Introduction to the Runoff Treatment BMP Selection Process .....	307
5.2.2 Step-by-Step Selection Process for Runoff Treatment BMPs .....	307
5.2.3 Other Treatment BMP Selection Factors .....	314
5.2.4 Cold Weather Considerations .....	319
5.3 General Requirements for Runoff Treatment BMPs .....	325
5.3.1 Introduction to the General Requirements for Runoff Treatment BMPs .....	325
5.3.2 Design Volume and Flow .....	325
5.3.3 Sequence of BMPs .....	326
5.3.4 Setbacks, Slopes, and Embankments .....	327
5.3.5 Operation and Maintenance Criteria .....	327
5.4 Surface Infiltration and Bioinfiltration BMPs .....	328
5.4.1 Purpose .....	328
5.4.2 Application .....	328
5.4.3 General Criteria for Infiltration and Bioinfiltration BMPs .....	329
5.4.4 Screening Criteria for Infiltration BMPs .....	335
5.4.5 Cold Weather Climate Considerations .....	337

---

5.4.6 Arid/Semiarid Climate Considerations .....	337
5.4.7 BMPs for Surface Infiltration and Bioinfiltration .....	338
BMP T5.10: Infiltration Ponds .....	338
BMP T5.20: Infiltration Trenches .....	338
BMP T5.21: Infiltration Swales .....	338
BMP T5.30: Bioinfiltration Swales .....	339
BMP T5.31: Bioretention .....	343
BMP T5.32: Permeable Pavement .....	385
5.5 Biofiltration BMPs .....	385
5.5.1 Purpose .....	385
5.5.2 Application .....	385
5.5.3 Cold Weather Climate Considerations .....	386
5.5.4 Arid/Semiarid Climate Considerations .....	386
5.5.5 BMPs for Biofiltration .....	387
Introduction to BMPs for Biofiltration .....	387
BMP T5.40: Biofiltration Swale .....	387
BMP T5.50: Vegetated Filter Strip .....	392
BMP T5.60: Compost-Amended Vegetated Filter Strip (CAVFS) .....	398
5.6 Subsurface Infiltration (Underground Injection Control Wells) .....	398
5.6.1 Introduction to UIC Wells .....	398
5.6.2 Rule-Authorization or Permit .....	399
5.6.3 Registration .....	400
5.6.4 Meeting the Non-Endangerment Standard .....	400
5.6.5 Well Assessment .....	402
5.6.6 Preservation and Maintenance Projects .....	403
5.6.7 Emergency Situations .....	403
5.6.8 The Presumptive Approach .....	404
5.6.9 The Demonstrative Approach .....	404

---

5.6.10 Siting and Design of New UIC Wells .....	405
5.6.11 Operation and Maintenance of UIC Wells .....	408
5.6.12 Prohibitions .....	408
5.6.13 Source Control and Runoff Treatment Requirements .....	409
5.6.14 Spills and Illicit Discharges .....	413
5.6.15 Deep UIC Wells .....	413
5.6.16 Determining Treatment Requirements .....	415
5.6.17 Classification of Vadose Zone Treatment Capacity .....	417
5.7 Wetpool/Wetpond and Dry Pond BMPs .....	427
5.7.1 Purpose .....	427
5.7.2 Application .....	436
5.7.3 Cold Weather Climate Considerations .....	438
5.7.4 Arid/Semiarid Climate Considerations .....	438
5.7.5 BMPs for Wetpools/Wetponds and Dry Ponds .....	438
BMP T5.70: Basic Wetpond .....	438
BMP T5.71: Large Wetpond .....	445
BMP T5.72: Wetvaults .....	445
BMP T5.73: Stormwater Treatment Wetland .....	450
BMP T5.74: Large Extended Detention Dry Pond .....	454
5.8 Filtration BMPs .....	454
5.8.1 Purpose .....	454
5.8.2 Application .....	457
5.8.3 Cold Weather Climate Considerations .....	458
5.8.4 Arid/Semiarid Climate Considerations .....	458
5.8.5 BMPs for Sand Filtration .....	459
BMP T5.80: Basic Sand Filter .....	459
BMP T5.81: Large Sand Filter .....	466
BMP T5.82: Sand Filter Vault .....	466

---

BMP T5.83: Linear Sand Filter .....	471
BMP T5.84: Media Filter Drain .....	473
5.9 Evaporation BMPs .....	474
BMP T5.90: Evaporation Ponds .....	474
5.10 Oil and Water Separator BMPs .....	475
5.10.1 Introduction to Oil and Water Separator BMPs .....	475
5.10.2 Purpose .....	475
5.10.3 Application .....	478
5.10.4 Cold Weather Climate Considerations .....	478
5.10.5 Arid/Semiarid Climate Considerations .....	479
5.10.6 BMPs for Oil and Water Separation .....	479
BMP T5.100: API Separator Bay .....	479
BMP T5.110: Coalescing Plate (CP) Separator Bay .....	487
5.11 Emerging Technologies .....	489
5.11.1 Background .....	489
5.11.2 Ecology Role in Evaluating Emerging Technologies .....	489
5.11.3 Local Jurisdiction Evaluation of Emerging Technologies .....	490
5.11.4 Assessing Levels of Development of Emerging Technologies .....	490
Appendix 5-A: Recommended Maintenance Criteria for Runoff Treatment BMPs .....	495
5.A.1 Introduction .....	495
5.A.2 Maintenance Criteria for Wetponds .....	497
5.A.3 Maintenance Criteria for Bioinfiltration/Infiltration Trenches/Basins .....	499
5.A.4 Maintenance Criteria for Closed Treatment Systems (Tanks/Vaults) .....	500
5.A.5 Maintenance Criteria for Control Structure/Flow Restrictor for Wetponds .....	501
5.A.6 Maintenance Criteria for Catch Basins .....	501
5.A.7 Maintenance Criteria for Debris Barriers (e.g., Trash Racks) .....	502
5.A.8 Maintenance Criteria for Energy Dissipaters .....	503
5.A.9 Maintenance Criteria for Biofiltration Swales .....	503

---

5.A.10 Maintenance Criteria for Vegetated Filter Strips .....	504
5.A.11 Maintenance Criteria for Wetvaults .....	505
5.A.12 Maintenance Criteria for Sand Filters (Aboveground/Open) .....	505
5.A.13 Maintenance Criteria for Sand Filters (Belowground/Enclosed) .....	506
5.A.14 Maintenance Criteria for Media Filters .....	507
5.A.15 Maintenance Criteria for Baffle Oil and Water Separators (API Type) .....	508
5.A.16 Maintenance Criteria for Coalescing Plate Oil and Water Separators .....	509
5.A.17 Maintenance Criteria for Catch Basin Inserts .....	509
5.A.18 Maintenance Criteria for Bioretention .....	510
5.A.19 Maintenance Criteria for Media Filter Drains (MFDs) .....	511
5.A.20 Maintenance Criteria for Compost-Amended Vegetated Filter Strip (CAVFS) .....	512
Appendix 5-B: Planting Recommendations .....	513
5.B.1 Introduction .....	513
5.B.2 Seeding Recommendations .....	514
5.B.3 Bioretention Planting Recommendations .....	515
5.B.4 Stormwater Treatment Wetlands Plant List .....	533
<b>Chapter 6 - Flow Control BMP Design .....</b>	<b>535</b>
6.1 Introduction .....	535
6.2 Detention BMPs .....	535
6.2.1 Purpose .....	535
6.2.2 Application .....	535
6.2.3 Cold Climate Considerations .....	537
6.2.4 Arid and Semiarid Climate Considerations .....	537
6.2.5 BMPs for Detention .....	537
BMP F6.10: Detention Ponds .....	537
BMP F6.11: Detention Tanks .....	550
BMP F6.12: Detention Vaults .....	555
BMP F6.13: Rainwater Harvesting .....	559

---

6.2.6 Control Structures .....	570
6.2.7 Supplemental Guidelines for Detention .....	582
6.3 Infiltration BMPs .....	582
6.3.1 Purpose .....	582
6.3.2 Application .....	583
6.3.3 General Criteria for Infiltration BMPs .....	584
6.3.4 Cold Climate Considerations .....	596
6.3.5 Arid and Semiarid Climate Considerations .....	596
6.3.6 BMPs for Infiltration .....	596
BMP F6.20: Drywells .....	596
BMP F6.21: Infiltration Ponds .....	601
BMP F6.22: Infiltration Trenches .....	604
BMP F6.23: Bioretention .....	612
BMP F6.24: Permeable Pavement .....	612
6.4 Evaporation BMPs .....	655
BMP F6.30: Evaporation Ponds .....	655
6.5 Dispersion BMPs .....	660
6.5.1 Introduction .....	660
6.5.2 Purpose .....	660
6.5.3 Application .....	661
6.5.4 Limitations .....	661
6.5.5 Cold Climate Considerations .....	662
6.5.6 Arid and Semiarid Climate Considerations .....	662
6.5.7 BMPs for Dispersion .....	662
BMP F6.40: Concentrated Flow Dispersion .....	662
BMP F6.41: Sheet Flow Dispersion .....	667
BMP F6.42: Full Dispersion .....	674
BMP F6.43: Channelized Flow Dispersion .....	679

---

6.6 Additional Flow Control BMPs .....	681
6.6.1 Purpose .....	681
6.6.2 Application .....	682
6.6.3 Cold Climate Considerations .....	682
6.6.4 Arid and Semiarid Climate Considerations .....	682
6.6.5 Additional BMPs for Flow Control .....	682
BMP F6.61: Amending Construction Site Soils .....	682
BMP F6.62: Trees .....	690
BMP F6.63: Vegetated Roofs .....	703
BMP F6.64: Minimal Excavation Foundations .....	711
Appendix 6-A: Recommended Maintenance Criteria for Flow Control BMPs .....	719
6.A.1 Introduction .....	719
6.A.2 Maintenance Criteria for Detention Ponds .....	721
6.A.3 Maintenance Criteria for Detention Vaults/Tanks .....	723
6.A.4 Maintenance Criteria for Control Structures .....	724
6.A.5 Maintenance Criteria for Catch Basins .....	724
6.A.6 Maintenance Criteria for Drywells .....	727
6.A.7 Maintenance Criteria for Infiltration Ponds .....	729
6.A.8 Maintenance Criteria for Evaporation Ponds .....	729
6.A.9 Maintenance Criteria for Rainwater Harvesting .....	731
6.A.10 Maintenance Criteria for Permeable Pavement .....	732
6.A.11 Maintenance Criteria for Amended Construction Site Soils .....	733
6.A.12 Maintenance Criteria for Vegetated Roofs .....	734
Appendix 6-B: Guidelines for Site Characterization of Geotechnical Properties .....	735
6.B.1 Geotechnical Site Characterization .....	735
6.B.2 Required Minimum Permeability for Use With Standard Drywell Practice .....	735
6.B.3 Recommended Field Test Procedures .....	737
6.B.4 Recommended Laboratory Test Procedures .....	744



---

<b>Chapter 7 - Construction Stormwater Pollution Prevention</b> .....	<b>747</b>
7.1 Introduction .....	747
7.1.1 Objective .....	747
7.1.2 Content and Organization of This Chapter .....	748
7.1.3 How to Use This Chapter .....	748
7.1.4 Thirteen Elements of Construction Stormwater Pollution Prevention .....	748
7.1.5 Erosion and Sedimentation Impacts .....	749
7.1.6 Erosion and Sedimentation Processes .....	750
7.1.7 Factors Influencing Erosion Potential .....	752
7.2 Planning .....	755
7.2.1 Introduction .....	755
7.2.2 General SWPPP Guidelines .....	756
7.2.3 Step-by-Step Procedure .....	758
7.2.4 Checklists for Construction SWPPPs .....	775
7.3 Standards and Specifications for Best Management Practices .....	780
7.3.1 Introduction .....	780
7.3.2 Source Control BMPs .....	780
BMP C101E: Preserving Natural Vegetation .....	780
BMP C102E: Buffer Zones .....	782
BMP C103E: High-Visibility Fence .....	783
BMP C105E: Stabilized Construction Access .....	784
BMP C106E: Wheel Wash .....	789
BMP C107E: Construction Road/Parking Area Stabilization .....	792
BMP C120E: Temporary and Permanent Seeding .....	793
BMP C121E: Mulching .....	805
BMP C122E: Nets and Blankets .....	808
BMP C123E: Plastic Covering .....	813
BMP C124E: Sodding .....	814

---

BMP C125E: Topsoiling/Composting .....	815
BMP C126E: Polyacrylamide for Soil Erosion Protection .....	819
BMP C130E: Surface Roughening .....	822
BMP C131E: Gradient Terraces .....	825
BMP C140E: Dust Control .....	828
BMP C150E: Materials on Hand .....	829
BMP C151E: Concrete Handling .....	830
BMP C152E: Sawcutting and Surfacing Pollution Prevention .....	832
BMP C153E: Material Delivery, Storage, and Containment .....	833
BMP C154E: Concrete Washout Area .....	835
BMP C160E: Certified Erosion and Sediment Control Lead .....	842
BMP C162E: Scheduling .....	843
7.3.3 Runoff Conveyance and Treatment BMPs .....	844
BMP C200E: Interceptor Dike and Swale .....	844
BMP C201E: Grass-Lined Channels .....	846
BMP C202E: Riprap Channel Lining .....	851
BMP C203E: Water Bars .....	852
BMP C204E: Pipe Slope Drains .....	855
BMP C205E: Subsurface Drains .....	859
BMP C206E: Level Spreader .....	861
BMP C207E: Check Dams .....	865
BMP C208E: Triangular Silt Dike (TSD) .....	868
BMP C209E: Outlet Protection .....	869
BMP C220E: Inlet Protection .....	870
BMP C231E: Brush Barrier .....	878
BMP C232E: Gravel Filter Berm .....	881
BMP C233E: Silt Fence .....	883
BMP C234E: Vegetated Strip .....	889

---

BMP C235E: Wattles .....	890
BMP C236E: Vegetative Filtration .....	893
BMP C240E: Sediment Trap .....	896
BMP C241E: Sediment Pond (Temporary) .....	901
BMP C250E: Construction Stormwater Chemical Treatment .....	909
BMP C251E: Construction Stormwater Filtration .....	916
BMP C252E: Treating and Disposing of High pH Water .....	918
Appendix 7-A: Recommended Standard Notes for Construction SWPPP Drawings .....	923
<b>Chapter 8 - Source Control .....</b>	<b>925</b>
8.1 Introduction .....	925
8.1.1 Purpose .....	925
8.1.2 Content and Organization of This Chapter .....	925
8.1.3 Operational and Structural Source Control BMPs .....	926
8.1.4 Runoff Treatment BMPs for Specific Pollutant Sources .....	926
8.1.5 Distinction Between Applicable BMPs and Recommended BMPs .....	927
8.2 Selection of Operational and Structural Source Control BMPs .....	928
8.2.1 Introduction .....	928
8.2.2 Source Control BMPs Applicable to All Sites .....	929
Introduction .....	929
S101E: BMPs for Formation of a Pollution Prevention Team .....	929
S102E: BMPs for Preventive Maintenance/Good Housekeeping .....	930
S104E: BMPs for Spill Prevention and Cleanup .....	932
S105E: BMPs for Employee Training .....	934
S106E: BMPs for Inspections .....	935
S107E: BMPs for Record Keeping .....	935
S108E: BMPs for Correcting Illicit Connections to Storm Drains .....	936
8.2.3 Pollutant Source-Specific BMPs .....	939
Introduction .....	939

---

S401E: BMPs for the Building, Repair, and Maintenance of Boats and Ships .....	943
S402E: BMPs for Commercial Animal Handling Areas .....	945
S403E: BMPs for Commercial Composting .....	946
S404E: BMPs for Commercial Printing Operations .....	947
S405E: BMPs for Deicing and Anti-Icing Operations – Airports .....	948
S406E: BMPs for Streets/Highways .....	949
S407E: BMPs for Dust Control at Disturbed Land Areas and Unpaved Roadways and Parking Lots .....	951
S408E: BMPs for Dust Control at Manufacturing Areas .....	952
S409E: BMPs for Fueling at Dedicated Stations .....	953
S411E: BMPs for Landscaping and Lawn/Vegetation Management .....	958
S412E: BMPs for Loading and Unloading Areas for Liquid or Solid Material .....	961
S413E: BMPs for Log Sorting and Handling .....	969
S414E: BMPs for Maintenance and Repair of Vehicles and Equipment .....	970
S415E: BMPs for Maintenance of Public and Private Utility Corridors and Facilities ....	972
S416E: BMPs for Maintenance of Roadside Ditches .....	973
S417E: BMPs for Maintenance of Drainage Systems and Runoff Treatment BMPs ....	975
S418E: BMPs for Manufacturing Activities – Outside .....	976
S419E: BMPs for Mobile Fueling of Vehicles and Heavy Equipment .....	980
S420E: BMPs for Painting/Finishing/Coating of Vehicles/Boats/Buildings/Equipment .	982
S421E: BMPs for Parking and Storage of Vehicles and Equipment .....	983
S422E: BMPs for Railroad Yards .....	984
S423E: BMPs for Recyclers and Scrap Yards .....	988
S424E: BMPs for Roof/Building Drains at Manufacturing and Commercial Buildings ...	989
S425E: BMPs for Soil Erosion and Sediment Control at Industrial Sites .....	990
S426E: BMPs for Spills of Oil and Hazardous Substances .....	991
S427E: BMPs for Storage of Liquid, Food Waste, or Dangerous Waste Containers ....	993
S428E: BMPs for Storage of Liquids in Permanent Aboveground Tanks .....	1000

---

S429E: BMPs for Storage or Transfer (Outside) of Solid Raw Materials, By-Products, or Finished Products .....	1003
S430E: BMPs for Urban Streets .....	1007
S431E: BMPs for Washing and Steam Cleaning Vehicles/Equipment/Building Structures .....	1009
S432E: BMPs for Wood Treatment Areas .....	1013
S433E: BMPs for Pools, Spas, Hot Tubs, and Fountains .....	1014
S434E: BMPs for Dock Washing .....	1016
S435E: BMPs for Pesticides and an Integrated Pest Management Program .....	1018
S436E: BMPs for Color Events .....	1022
S438E: BMPs for Construction Demolition .....	1026
S439E: BMPs for In-Water and Over-Water Fueling .....	1027
S440E: BMPs for Pet Waste .....	1029
S441E: BMPs for Potable Water Line Flushing, Water Tank Maintenance, and Hydrant Testing .....	1033
S442E: BMPs for Labeling Storm Drain Inlets on Your Property .....	1034
S443E: BMPs for Fertilizer Application .....	1037
S444E: BMPs for the Storage of Dry Pesticides and Fertilizers .....	1038
S445E: BMPs for Temporary Fruit Storage .....	1039
S446E: BMPs for Well, Utility, Directional, and Geotechnical Drilling .....	1040
S447E: BMPs for Roof Vents .....	1041
S449E: BMPs for Nurseries and Greenhouses .....	1042
S450E: BMPs for Irrigation .....	1044
S451E: BMPs for Building, Repair, Remodeling, Painting, and Construction .....	1046
S452E: BMPs for Goose Waste .....	1047
Appendix 8-A: Urban Land Uses and Pollution-Generating Sources .....	1051
8.A.1 Introduction .....	1051
8.A.2 Manufacturing Businesses .....	1051
8.A.3 Transportation and Communication .....	1062

---

8.A.4 Retail and Wholesale Businesses .....	1064
8.A.5 Service Businesses .....	1069
8.A.6 Public Agency Activities .....	1075
Appendix 8-B: Management of Street Waste Solids and Liquids .....	1079
8.B.1 Introduction .....	1079
8.B.2 Regulations for Street Waste Management .....	1079
8.B.3 Contaminants in Street Waste Solids .....	1081
8.B.4 Street Waste Liquids .....	1084
8.B.5 Collection Site Assessment .....	1088
Appendix 8-C: Stormwater Pollutants and Their Adverse Impacts .....	1091
<b>Glossary .....</b>	<b>1093</b>
<b>References .....</b>	<b>1139</b>

## List of Tables

---

Table 1.1: Mean Concentrations of Selected Pollutants in Stormwater Runoff From Different Land Uses .....	51
Table 3.1: Grid and Curvilinear Street Network Comparison .....	152
Table 4.1: Comparison of Hydrologic Analysis Methods for Runoff Treatment and Flow Control BMP Design .....	171
Table 4.2: Climate Region Summary .....	174
Table 4.3: Comparison of Design Storm Distributions .....	177
Table 4.4: Antecedent Precipitation Prior to Regional Storm .....	187
Table 4.5: Values of Coefficient $C_{wqs}$ for Computing 6-Month, 24-Hour Precipitation .....	192
Table 4.6: Factors for Converting From 24-Hour to Regional Storm Precipitation Depth .....	192
Table 4.7: Values of the Coefficient $C_{sds}$ for Using 2-Year, 2-Hour Precipitation to Compute 2-Hour Precipitation for Selected Periods of Return .....	193
Table 4.8: Average Annual Snowfall at Selected Locations in Eastern Washington .....	194
Table 4.9: Snowmelt Adjustment Factors .....	197
Table 4.10: Melt Rate Coefficients for Various Conditions (Assuming $T_{base} = 32^{\circ}F$ ) .....	199
Table 4.11: Values of $n$ and $k$ for Use in Computing Time of Concentration .....	215

---

Table 4.12: Other Values of the Roughness Coefficient $n$ for Channel Flow .....	216
Table 4.13: Hydrologic Soil Series for Selected Soils in Eastern Washington .....	223
Table 4.14: Runoff Curve Numbers (CNs) for Selected Agricultural, Suburban, and Urban Areas .....	225
Table 4.15: Total 5-Day Antecedent Rainfall .....	227
Table 4.16: Curve Number Conversions for Antecedent Moisture Conditions (Case Ia = 0.2S) .....	227
Table 4.17: Curve Number Example .....	229
Table 4.18: Values of Runoff Coefficient $C$ for Use in Rational Method With Return Intervals of 10 Years or Less .....	233
Table 4.19: Values of Rainfall Coefficients $m$ and $n$ for Selected Cities .....	235
Table 4.20: Values of Ground Cover Coefficient $K$ .....	237
Table 4.21: Comparisons to the Type IA Storm .....	253
Table 4.22: Long-Duration Storms for Climate Region 1 – Cascade Mountains .....	257
Table 4.23: Long-Duration Storms for Climate Region 2 – Central Basin .....	258
Table 4.24: Long-Duration Storms for Climate Region 3 – Okanogan/Spokane/Palouse .....	258
Table 4.25: Long-Duration Storms for Climate Region 4 – Northeastern Mountains and Blue Mountains .....	259
Table 4.26: Short-Duration Storms for All Climate Regions .....	260
Table 4.27: 72-Hour Long-Duration Storm Hyetograph Values for Climate Region 1: Cascade Mountains .....	268
Table 4.28: 72-Hour Long-Duration Storm Hyetograph Values for Climate Region 2: Central Basin .....	271
Table 4.29: 72-Hour Long-Duration Storm Hyetograph Values for Climate Region 3: Okanogan, Spokane, Palouse .....	274
Table 4.30: 72-Hour Long-Duration Storm Hyetograph Values for Climate Region 4: Eastern Mountains .....	277
Table 4.31: SCS Type IA Storm Hyetograph Values .....	281
Table 4.32: SCS Type II Storm Hyetograph Values .....	285
Table 4.33: Short-Duration Storm Hyetograph Values for All Climate Regions .....	290
Table 4.34: Regional Storm Hyetograph Values for Climate Region 1: Cascade Mountains ..	291

---

Table 4.35: Regional Storm Hyetograph Values for Climate Region 2: Central Basin .....	292
Table 4.36: Regional Storm Hyetograph Values for Climate Region 3: Okanogan, Spokane, Palouse .....	293
Table 4.37: Regional Storm Hyetograph Values for Climate Region 4: Eastern Mountains ....	295
Table 5.1: Treatment Trains for Phosphorus Removal .....	305
Table 5.2: Treatment Trains for Dissolved Metals Removal .....	307
Table 5.3: Typical Sources of Pollutants of Concern in Stormwater .....	315
Table 5.4: Ability of Runoff Treatment BMPs to Remove Key Pollutants .....	316
Table 5.5: Screening Treatment BMPs Based on Soil Type .....	317
Table 5.6: Recommended Stormwater Treatment BMPs Based on Climate Type .....	318
Table 5.7: Cold Weather Challenges to BMP Design .....	321
Table 5.8: Summary of BMP Applicability in Cold Regions .....	324
Table 5.9: Applicability of Surface Infiltration and Bioinfiltration BMPs for Runoff Treatment, Flow Control, and Conveyance .....	329
Table 5.10: Infiltration Rates for Surface Infiltration and Bioinfiltration BMPs .....	330
Table 5.11: Site Suitability Criteria Applicability .....	331
Table 5.12: Bioinfiltration Swale Sizing Table for Design Infiltration Rates in the Range of 0.15 to 0.40 Inches/Hour .....	341
Table 5.13: Bioinfiltration Swale Sizing Table for Design Infiltration Rates in the Range of 0.41 to 1.00 Inches/Hour .....	342
Table 5.14: Guideline for BSM Mineral Aggregate Gradation .....	362
Table 5.15: Underdrain Aggregate Filter and Bedding Layer Gradation .....	369
Table 5.16: Sizing Methods and Assumptions for Bioretention .....	380
Table 5.17: Applicability of Biofiltration BMPs for Runoff Treatment, Flow Control, and Conveyance .....	386
Table 5.18: Sizing Methods and Assumptions for Biofiltration Swales .....	390
Table 5.19: Sizing Methods and Assumptions for Vegetated Filter Strips .....	394
Table 5.20: Examples of Geologic Material Descriptions .....	417
Table 5.21: Vadose Zone Treatment Capacity .....	422
Table 5.22: Pollutant Loading Classifications for Solids, Metals, and Oil in Stormwater Runoff	425



---

Directed to UIC Wells .....	
Table 5.23: Treatment Required for Solids, Oil, and Metals .....	426
Table 5.24: Applicability of Wetpool/Wetpond and Dry Pond Treatment BMPs for Runoff Treatment, Flow Control, and Conveyance .....	437
Table 5.25: Wetpond Sizing for Basic Treatment Design .....	444
Table 5.26: Schedule of Vault Width Versus Sediment Depth .....	446
Table 5.27: Distribution of Depths in Wetland Cell .....	451
Table 5.28: Applicability of Sand Filtration BMPs for Runoff Treatment, Flow Control, and Conveyance .....	458
Table 5.29: Sand Media Specification .....	460
Table 5.30: Clay Liner Specifications .....	461
Table 5.31: Sizing Methods and Assumptions for Basic Sand Filter BMPs .....	463
Table 5.32: Sediment Cell Width as a Function of Sand Filter Width .....	473
Table 5.33: Applicability of Oil and Water Separator BMPs for Runoff Treatment, Flow Control, and Conveyance .....	478
Table 5.34: Sizing Methods and Assumptions for BMP T5.100 API Separator Bay (Method 1) .....	484
Table 5.35: TAPE Treatment Goals and Water Quality Parameters .....	492
Table 5.36: Maintenance Criteria for Wetponds .....	497
Table 5.37: Maintenance Criteria for Bioinfiltration/Infiltration Trenches/Basins .....	499
Table 5.38: Maintenance Criteria for Closed Treatment Systems (Tanks/Vaults) .....	500
Table 5.39: Maintenance Criteria for Control Structure/Flow Restrictor for Wetponds .....	501
Table 5.40: Maintenance Criteria for Catch Basins .....	501
Table 5.41: Maintenance Criteria for Debris Barriers (e.g., Trash Racks) .....	502
Table 5.42: Maintenance Criteria for Energy Dissipaters .....	503
Table 5.43: Maintenance Criteria for Biofiltration Swales .....	503
Table 5.44: Maintenance Criteria for Vegetated Filter Strips .....	504
Table 5.45: Maintenance Criteria for Wetvaults .....	505
Table 5.46: Maintenance Criteria for Sand Filters (Aboveground/Open) .....	505
Table 5.47: Maintenance Criteria for Sand Filters (Belowground/Enclosed) .....	506

---

Table 5.48: Maintenance Criteria for Media Filters .....	507
Table 5.49: Maintenance Criteria for Baffle Oil and Water Separators (API Type) .....	508
Table 5.50: Maintenance Criteria for Coalescing Plate Oil and Water Separators .....	509
Table 5.51: Maintenance Criteria for Catch Basin Inserts .....	509
Table 5.52: Maintenance Criteria for Bioretention .....	510
Table 5.53: Maintenance Criteria for Media Filter Drains (MFDs) .....	511
Table 5.54: Maintenance Criteria for Compost-Amended Vegetated Filter Strip (CAVFS) ....	512
Table 5.55: Recommended Seeding Mixes for Runoff Treatment BMPs .....	514
Table 5.56: Recommended Trees for Bioretention BMPs .....	519
Table 5.57: Recommended Shrubs for Bioretention BMPs .....	521
Table 5.58: Recommended Grasses for Bioretention BMPs .....	525
Table 5.59: Recommended Perennials and Wildflowersfor Bioretention BMPs .....	526
Table 5.60: Recommended Ground Covers for Bioretention BMPs .....	531
Table 5.61: Emergent Wetland Plant Species Recommended for Stormwater Treatment Wet-lands in Arid and Cold Climates in Eastern Washington .....	533
Table 6.1: Applicability of Detention BMPs for Runoff Treatment, Flow Control, and Con-veyance .....	536
Table 6.2: Applicability of Infiltration BMPs for Runoff Treatment, Flow Control, and Con-veyance .....	584
Table 6.3: Infiltration Testing and Evaluation Methods .....	587
Table 6.4: Correction Factors for In-Situ Ksat Measurements to Estimate Long-Term Design Infiltration Rates of Subgrade Soils Underlying Infiltration BMPs .....	594
Table 6.5: Sizing Methods and Assumptions for Permeable Pavement .....	617
Table 6.6: Curve Number Adjustment for Antecedent Moisture Condition .....	657
Table 6.7: Example Calculations for Sizing an Evaporation Pond at a Site in the Spokane Area .....	659
Table 6.8: Applicability of Dispersion BMPs for Runoff Treatment, Flow Control, and Con-veyance .....	661
Table 6.9: Peak Intensity Factors for Calculating Rainfall Intensity .....	671
Table 6.10: Percentage of Site With Undisturbed Native Vegetation Versus Percentage of Site With Impervious Surface Draining to Areas of Preserved Native Vegetation .....	675

---

Table 6.11: Applicability of Additional Flow Control BMPs for Runoff Treatment, Flow Control, and Conveyance .....	682
Table 6.12: Runoff Modeling Adjustments for Retained Trees .....	701
Table 6.13: Modeling Adjustments for Newly Planted Trees .....	702
Table 6.14: Sizing Methods and Assumptions for Vegetated Roofs .....	710
Table 6.15: Maintenance Criteria for Detention Ponds .....	721
Table 6.16: Maintenance Criteria for Detention Vaults/Tanks .....	723
Table 6.17: Maintenance Criteria for Control Structures .....	724
Table 6.18: Maintenance Criteria for Catch Basins .....	724
Table 6.19: Maintenance Criteria for Drywells .....	727
Table 6.20: Maintenance Criteria for Infiltration Ponds .....	729
Table 6.21: Maintenance Criteria for Evaporation Ponds .....	729
Table 6.22: Maintenance Criteria for Rainwater Harvesting .....	731
Table 6.23: Maintenance Criteria for Permeable Pavement .....	732
Table 6.24: Maintenance Criteria for Amended Construction Site Soils .....	733
Table 6.25: Maintenance Criteria for Vegetated Roofs .....	734
Table 7.1: Stabilized Construction Entrance Geotextile Standards .....	787
Table 7.2: Stabilized Construction Entrance Alternative Material Requirements .....	788
Table 7.3: Temporary Seeding .....	795
Table 7.4: Permanent Seed Mixes: Upland Areas with Less than 12 Inches Precipitation .....	796
Table 7.5: Permanent Seed Mixes: Upland Areas That Receive 12 to 15 Inches Precipitation .....	797
Table 7.6: Permanent Seed Mixes: Upland Areas With 15 to 18 Inches Precipitation .....	798
Table 7.7: Permanent Seed Mixes: Upland Areas With 18 to 24 Inches Precipitation .....	798
Table 7.8: Permanent Seed Mixes: Upland Areas With More Than 24 Inches Precipitation ...	799
Table 7.9: Permanent Seed Mixes: Grassed Waterways With Fewer Than 15 Inches Precipitation .....	800
Table 7.10: Permanent Seed Mixes: Grassed Waterways With 15 to 18 Inches Precipitation ..	801
Table 7.11: Permanent Seed Mixes: Grassed Waterways With More Than 18 Inches Precipitation .....	802

---

Table 7.12: Permanent Seed Mixes: Stabilization of Ski Slopes and Subalpine Areas .....	802
Table 7.13: Mulch Standards and Guidelines .....	806
Table 7.14: Size Gradations of Compost as Mulch Material .....	807
Table 7.15: Polyacrylamide and Water Application Rates .....	820
Table 7.16: Horizontal Spacing of Interceptor Dikes Along Ground Slope .....	845
Table 7.17: Water Bar Spacing Guidelines .....	852
Table 7.18: Storm Drain Inlet Protection .....	871
Table 7.19: Geotextile Fabric Standards for Silt Fence .....	884
Table 7.20: Contributing Area for Vegetated Strips .....	889
Table 7.21: Flow Path Guidelines for Vegetative Filtration .....	894
Table 8.1: Applicable Categories for Pollutant-Specific Source Control BMPs .....	940
Table 8.2: Typical TPH Levels in Street Sweeping and Catch Basin Solids .....	1082
Table 8.3: Typical c-PAH Values in Street Waste Solids and Related Materials .....	1083
Table 8.4: Typical Metals Concentrations in Catch Basin Sediments .....	1084
Table 8.5: Pollutants in Catch Basin Solids - Comparison to Dangerous Waste Criteria .....	1084
Table 8.6: Typical Street Waste Decant Values Compared to Surface Water Quality Criteria	1086
Table 8.7: Typical Values for Conventional Pollutants in Street Waste Decant .....	1087
Table 8.8: Street Waste Decant Values Following Settling .....	1087

## List of Figures

---

Figure 1.1: Relation Between Environmental Science and Standards in Stormwater Regu- lations .....	46
Figure 1.2: Changes in Hydrology After Development .....	54
Figure 2.1: Flow Chart for Determining Applicable Core Elements for New Development Pro- jects .....	73
Figure 2.2: Flow Chart for Determining Applicable Core Elements for Redevelopment Projects	76
Figure 2.3: Flow Chart for Determining Applicable Requirements for Core Element #5 for New Development and Redevelopment Projects .....	90
Figure 3.1: Subbasin Delineation for Designing Distributed LID Practices .....	130
Figure 3.2: Soil Texture Triangle .....	134

---

Figure 3.3: Composite Site Map .....	140
Figure 3.4: Bioretention Snow Storage .....	148
Figure 3.5: Grid Street Network .....	150
Figure 3.6: Curvilinear Street Network .....	151
Figure 3.7: Loop and Grid Hybrid Street Network .....	153
Figure 3.8: Application of LID .....	156
Figure 3.9: Parking and Queuing .....	158
Figure 3.10: Parking Lot Applications .....	160
Figure 3.11: Streetscape Applications .....	162
Figure 3.12: Building Applications .....	167
Figure 4.1: Average Annual Precipitation and Climate Regions .....	175
Figure 4.2: Short-Duration Storm Unit Hyetograph .....	181
Figure 4.3: Sample Regional Storm Hyetograph .....	183
Figure 4.4: SCS Type IA Hyetograph .....	185
Figure 4.5: SCS Type II Hyetograph .....	186
Figure 4.6: 2-Year, 2-Hour Isopluvial Map .....	189
Figure 4.7: 2-Year, 24-Hour Isopluvial Map .....	191
Figure 4.8: Snowmelt Infiltration as a Function of Soil Moisture .....	202
Figure 4.9: 10-Year, 24-Hour Isopluvial Map .....	205
Figure 4.10: 25-Year, 24-Hour Isopluvial Map .....	206
Figure 4.11: 50-Year, 24-Hour Isopluvial Map .....	207
Figure 4.12: 100-Year, 24-Hour Isopluvial Map .....	208
Figure 4.13: Seasonality of Short-Duration Thunderstorms in Eastern Washington .....	242
Figure 4.14: Seasonality of Long-Duration General Storms for the East Slopes of the Cascade Mountains .....	244
Figure 4.15: Seasonality of Long-Duration General Storms for the Central Basin, Okanogan, Spokane, and Palouse .....	245
Figure 4.16: Seasonality of Long-Duration General Storms for the Northeastern Mountains and Blue Mountains .....	246

---

Figure 4.17: Example Long-Duration Design Storm .....	248
Figure 4.18: Example Short-Duration Design Storm .....	250
Figure 4.19: Standard and Regional Storm Distribution Curves on a Unit Basis .....	254
Figure 4.20: Long-Duration Design Storm for Climate Region 1 .....	264
Figure 4.21: Long-Duration Design Storm for Climate Region 2 .....	265
Figure 4.22: Long-Duration Design Storm for Climate Region 3 .....	266
Figure 4.23: Long-Duration Design Storm for Climate Region 4 .....	267
Figure 5.1: Runoff Treatment BMP Selection Flow Chart .....	309
Figure 5.2: Runoff Treatment BMP Selection Flow Chart for Discharges to Subsurface Infiltration Systems .....	310
Figure 5.3: Typical Bioretention Swale .....	344
Figure 5.4: Typical Bioretention Planter .....	345
Figure 5.5: Recommended Utility Setbacks for Bioretention .....	350
Figure 5.6: Typical Curb Extension Inlet .....	354
Figure 5.7: Typical Concrete Curb Inlet .....	355
Figure 5.8: Typical Trench Drain Inlet .....	356
Figure 5.9: Bioretention Rockery Wall Detail .....	358
Figure 5.10: Typical Bioretention Outlet Structure .....	360
Figure 5.11: Typical Uprturned Bioretention Underdrain .....	370
Figure 5.12: Typical Bioretention Check Dam .....	372
Figure 5.13: Typical Bioretention Planter Section With Liner .....	374
Figure 5.14: Vegetated Filter Strip Design Graph .....	396
Figure 5.15: Typical Vegetated Filter Strip .....	397
Figure 5.16: Schematic Vadose Zone Treatment Layer Example .....	419
Figure 5.17: Wetpond/Wetpool (Plan View) .....	429
Figure 5.18: Wetpond (Sections) .....	430
Figure 5.19: Wetvault .....	432
Figure 5.20: Stormwater Treatment Wetland — Option A .....	434

---

Figure 5.21: Stormwater Treatment Wetland — Option B .....	435
Figure 5.22: Sand Filter .....	456
Figure 5.23: Sand Filter Vault .....	467
Figure 5.24: Sand Filter Vault (cont'd) .....	468
Figure 5.25: Sand Filter Vault (Also Called Underground Sand Filter) .....	469
Figure 5.26: Linear Sand Filter .....	472
Figure 5.27: API (Baffle-Type) Separator .....	476
Figure 5.28: Coalescing Plate Separator .....	477
Figure 5.29: Recommended Values of F for Various Values of $V_h/V_t$ .....	486
Figure 5.30: Bioretention Soil Moisture Zones .....	517
Figure 5.31: Example Planting Scheme for a Bioretention Swale in Spokane .....	518
Figure 6.1: Typical Detention Pond .....	546
Figure 6.2: Typical Detention Pond Sections .....	547
Figure 6.3: Overflow Structure .....	548
Figure 6.4: Weir Section for Emergency Overflow Spillway .....	549
Figure 6.5: Typical Detention Tank .....	553
Figure 6.6: Detention Tank Access Detail .....	554
Figure 6.7: Typical Detention Vault .....	558
Figure 6.8: Polyethylene Cistern .....	560
Figure 6.9: Cistern Used to Meet Irrigation Requirements .....	561
Figure 6.10: Flow Restrictor (Tee) .....	571
Figure 6.11: Flow Restrictor (Weir) .....	572
Figure 6.12: Simple Orifice .....	575
Figure 6.13: Rectangular, Sharp Crested Weir .....	577
Figure 6.14: V-Notch, Sharp-Crested Weir .....	579
Figure 6.15: Riser Inflow Curves .....	581
Figure 6.16: Typical Infiltration Drywell – City of East Wenatchee .....	598
Figure 6.17: Typical Infiltration Drywell – Spokane County .....	599

---

Figure 6.18: Typical Infiltration Drywell – City of Kennewick .....	600
Figure 6.19: Infiltration Pond With Settling Pond .....	603
Figure 6.20: Typical Infiltration Trench/Pond .....	607
Figure 6.21: Schematic of an Infiltration Trench .....	608
Figure 6.22: Parking Lot Perimeter Trench Design .....	609
Figure 6.23: Median Strip Trench Design .....	610
Figure 6.24: Observation Well Details .....	611
Figure 6.25: Impermeable Check Dams on Permeable Pavement with Sloped Subgrade .....	624
Figure 6.26: Elevated Drain Designs for Permeable Pavement Aggregate Base/Reservoir ..	628
Figure 6.27: Conceptual Diagram of the Load Distribution Provided by Rigid (Pervious Concrete) and Flexible Permeable Pavements and the Aggregate Base .....	630
Figure 6.28: Typical Porous Asphalt Section .....	633
Figure 6.29: Typical Permeable Interlocking Concrete Paver Section .....	641
Figure 6.30: Typical Concentrated Flow Dispersion for Steep Driveways .....	664
Figure 6.31: Sheet Flow Dispersion for Driveways for Option 3 .....	673
Figure 6.32: Standard Dispersion Trench With Notched Grade Board .....	678
Figure 6.33: Soil Maturation Process .....	684
Figure 6.34: Illustration of How a Tree Can Intercept and Infiltrate Stormwater .....	691
Figure 6.35: Silva Cell Filled With Bioretention Soil Mix and Topped With Permeable Pavers ..	697
Figure 6.36: Sand-Based Structural Soil Section .....	700
Figure 6.37: Basic Vegetated Roof Components .....	706
Figure 6.38: Pier-Type Minimal Excavation Foundation .....	714
Figure 6.39: Wall-Type Minimal Excavation Foundation .....	715
Figure 7.1: Types of Erosion .....	751
Figure 7.2: Factors Influencing Erosion Potential .....	753
Figure 7.3: Stabilized Construction Entrance .....	786
Figure 7.4: Wheel Wash .....	791
Figure 7.5: Channel Installation .....	811



---

Figure 7.6: Slope Installation .....	812
Figure 7.7: Surface Roughening by Tracking and Contour Furrows .....	824
Figure 7.8: Gradient Terraces .....	827
Figure 7.9: Concrete Washout Area with Wood Planks .....	839
Figure 7.10: Concrete Washout Area with Straw Bales .....	840
Figure 7.11: Prefabricated Concrete Washout Container with Ramp .....	841
Figure 7.12: Typical Grass-Lined Channels .....	849
Figure 7.13: Temporary Channel Liners .....	850
Figure 7.14: Water Bars .....	854
Figure 7.15: Pipe Slope Drain .....	858
Figure 7.16: Cross Section of Level-Spreader .....	863
Figure 7.17: Detail of Level Spreader .....	864
Figure 7.18: Rock Check Dam .....	867
Figure 7.19: Block and Gravel Filter .....	873
Figure 7.20: Block and Gravel Curb Inlet Protection .....	876
Figure 7.21: Curb and Gutter Barrier .....	877
Figure 7.22: Typical Brush Barrier .....	880
Figure 7.23: Gravel Filter Berm .....	882
Figure 7.24: Silt Fence .....	887
Figure 7.25: Silt Fence Installation by Slicing Method .....	888
Figure 7.26: Wattles .....	892
Figure 7.27: Manifold and Branches in a Wooded, Vegetated Spray Field .....	895
Figure 7.28: Cross-Section of Sediment Trap .....	899
Figure 7.29: Sediment Trap Outlet .....	900
Figure 7.30: Sediment Pond Plan View .....	904
Figure 7.31: Sediment Pond Cross Section .....	905
Figure 7.32: Sediment Pond Riser Detail .....	906
Figure 7.33: Riser Inflow Curves .....	907

---

Figure 8.1: Covered Fuel Island .....	956
Figure 8.2: Drip Pan .....	963
Figure 8.3: Drip Pan within Rails .....	965
Figure 8.4: Loading Dock with Door Skirt .....	967
Figure 8.5: Loading Dock with Overhang .....	968
Figure 8.6: Enclose the Activity .....	978
Figure 8.7: Cover the Activity .....	979
Figure 8.8: Installed Railroad Track Mats .....	987
Figure 8.9: Secondary Containment System .....	994
Figure 8.10: Locking System for Drum Lid .....	996
Figure 8.11: Covered and Bermed Containment Area .....	998
Figure 8.12: Mounted Container – with Drip Pan .....	999
Figure 8.13: Above-Ground Tank Storage .....	1002
Figure 8.14: Covered Storage Area for Bulk Solids (include berm if needed) .....	1005
Figure 8.15: Material Covered with Plastic Sheeting .....	1006
Figure 8.16: Uncovered Wash Area .....	1012
Figure 8.17: Powdered Dyes at Color Events .....	1023
Figure 8.18: Example of a Pet Waste Baggie Station .....	1031
Figure 8.19: Examples of Pet Waste Signs .....	1032
Figure 8.20: Storm Drain Inlet Labels .....	1036

# Chapter 1 - Introduction

## 1.1 Purpose and Scope

### 1.1.1 Objective

The objective of the *Stormwater Management Manual for Eastern Washington* (manual) is to provide guidance in stormwater design and management for eastern Washington. The manual aims to provide a commonly accepted set of technical standards in addition to presenting new design information and new approaches to stormwater management. These stormwater management practices, if properly applied at a project site, should protect water quality in the receiving waters (both surface and ground waters). Improperly managed stormwater runoff is a source of water quality and habitat degradation in urban areas. A number of existing laws and regulations require that project proponents properly manage stormwater runoff to avoid adverse impacts on water quality and aquatic resources. This manual is intended to provide technically sound and realistic guidance on how to properly manage stormwater runoff from individual project sites.

This manual identifies eight Core Elements for managing stormwater runoff from new development and redevelopment projects of all sizes. The manual also provides guidance for preparation and implementation of Stormwater Site Plans (SSPs). The requirements of the Core Elements are generally satisfied by the application of Best Management Practices (BMPs) selected from [Chapter 5 - Runoff Treatment BMP Design](#) through [Chapter 8 - Source Control](#) of this manual. Projects that follow this approach will apply reasonable, technology-based BMPs and water quality-based BMPs to reduce the adverse impacts of stormwater runoff.

This manual is applicable to all types of land development. BMPs for residential, commercial and industrial development and road projects are included. A manual with a more specific focus, such as the Washington State Department of Transportation (WSDOT) Highway Runoff Manual or a stormwater manual adopted by a local jurisdiction, may provide more appropriate guidance to the project proponent. See local jurisdiction manuals where available and ensure that all local requirements are met (see [2.7.9 Core Element #8: Local Requirements](#) for additional information).

The manual is limited in scope for addressing environmental problems caused by urbanization. The manual does not include site development standards or limit where development should be allowed. Project-by-project management of stormwater runoff from new development and redevelopment alone will not correct existing water quality and instream habitat problems. The engineered runoff treatment and flow control BMPs recommended in this manual can reduce the adverse impacts of development, but such BMPs cannot remove sufficient pollutants to replicate the predevelopment water quality, nor can they replicate the natural functions of the watershed that existed before development.

This manual is applicable to all of eastern Washington, including the area bounded on the west by the Cascade Mountains crest; on the north by the Canadian border; on the east by the Idaho border; and on the south by the Oregon border. At the southern end of Washington's Cascade Mountain range where the crest does not follow county borders, this manual is applicable to all of Yakima and Klickitat Counties.

## 1.1.2 The Manual's Role as Technical Guidance

The *Stormwater Management Manual for Eastern Washington* is not a regulation. The manual does not have any independent regulatory authority and it does not establish new environmental regulatory requirements. Current law and regulations require project proponents to design, construct, operate, and maintain stormwater treatment systems that prevent pollution of state waters. The manual is a guidance document that provides local jurisdictions, state and federal agencies, developers and project proponents with a set of stormwater management practices. If these practices are implemented correctly, they should result in compliance with existing regulatory requirements for stormwater, including compliance with the federal Clean Water Act, federal Safe Drinking Water Act and state Water Pollution Control Act.

The purpose of this manual is to provide technical guidance on measures to control the quantity and quality of stormwater runoff from new development and redevelopment projects. These measures are considered to be necessary to achieve compliance with state water quality standards and to contribute to the protection of the beneficial uses of the receiving waters (both surface and ground waters). Stormwater management techniques applied in accordance with this manual are presumed to meet the technology-based treatment requirement of state law to provide all known available and reasonable methods of treatment, prevention, and control (AKART; [RCW 90.52.040](#) and [RCW 90.48.010](#)).

This technology-based treatment requirement does not relieve dischargers from the obligation to apply additional stormwater management practices as necessary to comply with state water quality standards. The state water quality standards include [Chapter 173-200 WAC](#), Water Quality Standards for Ground Waters of the State of Washington; [Chapter 173-201A WAC](#), Water Quality Standards for Surface Waters of the State of Washington; and [Chapter 173-204 WAC](#), Sediment Management Standards. Additional treatment to meet those standards may be required by federal, state, or local jurisdictions.

Following this manual is not the only way to properly manage stormwater runoff. A project proponent may choose to implement other practices to protect water quality; but in this case, the project proponent assumes the responsibility of providing technical justification that the chosen practices will protect water quality (see [1.1.4 Presumptive Versus Demonstrative Approaches to Protecting Water Quality](#)).

## 1.1.3 More Stringent Measures and Retrofitting

Federal agencies, state agencies, and local jurisdictions can require more stringent measures that are deemed necessary to meet locally established goals, state water quality standards, or other established natural resource or drainage objectives. Water cleanup plans or Total Maximum Daily Loads (TMDLs) may identify more stringent measures needed to restore water quality in an impaired water body.

This manual is not a retrofit manual, but it can be helpful in identifying options for retrofitting BMPs to existing development. Stormwater retrofitting (or renovating existing structures or BMPs into existing developed areas) may be necessary to meet federal Clean Water Act and State Water Pollution Control Act ([Chapter 90.48 RCW](#)) requirements. In some cases, stormwater retrofitting may be desirable and cost-effective for helping to achieve water quality, hydrologic, and watershed ecological restoration targets, even when retrofits are not required.

In retrofit situations, there frequently are site constraints that make the strict application of the BMPs presented in this manual difficult to apply. In these instances, the BMPs presented here can be modified using best professional judgment in accordance with local jurisdiction requirements to provide reasonable improvements in stormwater management.

### **1.1.4 Presumptive Versus Demonstrative Approaches to Protecting Water Quality**

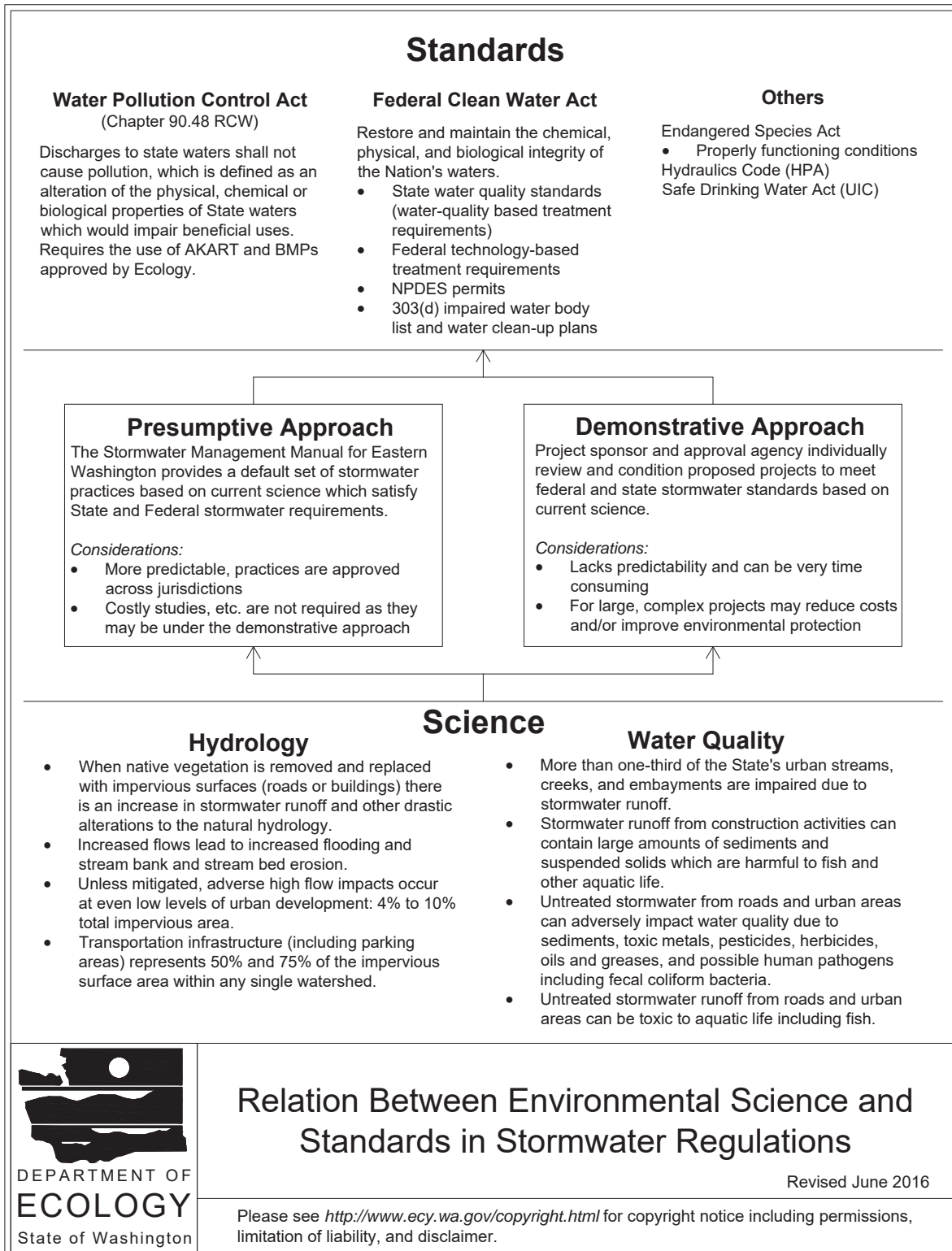
Wherever a discharge permit or other water-quality-based project approval is required, project proponents may be required to document the technical basis for the design criteria used to design their stormwater management BMPs. This includes: how stormwater BMPs were selected; the pollutant removal performance expected from the selected BMPs; the scientific basis, technical studies, and/or analysis which supports the performance claims for the selected BMPs; and an assessment of how the selected BMP will comply with state water quality standards and satisfy state AKART requirements and federal technology-based treatment requirements.

The manual is intended to provide project proponents, regulatory agencies, and others with technically sound stormwater management practices that are *presumed* to protect water quality and instream habitat and meet the stated environmental objectives of the regulations described in this chapter. Project proponents always have the option of not following the stormwater management practices in this manual. However, if a project proponent chooses not to follow the practices in the manual then the project proponent may be required to individually *demonstrate* that the project will not adversely impact water quality by collecting and providing appropriate supporting data to show that the alternative approach is protective of water quality and satisfies state and federal water quality laws.

[Figure 1.1: Relation Between Environmental Science and Standards in Stormwater Regulations](#) graphically depicts the relation between the *presumptive approach* (the use of this manual) and the *demonstrative approach* for achieving the environmental objectives of the standards. Both the presumptive and demonstrative approaches are based on best available science and result from existing federal and state laws that require stormwater treatment systems to be properly designed, constructed, maintained, and operated to:

1. Prevent pollution of state waters and protect water quality, including compliance with state water quality standards.
2. Satisfy state requirements for AKART of wastes prior to discharge to waters of the state.
3. Satisfy the federal technology-based treatment requirements under [40 CFR 125.3](#).

**Figure 1.1: Relation Between Environmental Science and Standards in Stormwater Regulations**



Under the demonstration approach, the timeline and expectations for providing technical justification of stormwater management practices will depend on the complexity of the individual project and the nature of the receiving environment. In each case, the project proponent may be asked to document to the satisfaction of the permitting agency or other approval authority that the practices which have been selected for the individual project will result in compliance with the water quality protection requirements of the permit or other local, state, or federal water-quality-based project approval condition(s). This approach may be more cost-effective for large, complex, or unusual types of projects.

Project proponents who choose to follow the stormwater management practices contained in approved stormwater technical manuals are presumed to have satisfied this demonstration requirement and do not need to provide technical justification to support the selection of BMPs for the project. Following the stormwater management practices in this manual means adhering to the guidance provided for proper selection, design, construction, implementation, operation, and maintenance of BMPs. Approved stormwater technical manuals include this manual and other equivalent stormwater management guidance documents approved by the Washington State Department of Ecology. This approach will generally be more cost-effective for typical new development and redevelopment projects.

### **1.1.5 Comparison of the Stormwater Management Manuals for Eastern and Western Washington**

After crossing from western to eastern Washington from any mountain pass, one thing is apparent: eastern Washington is very different from western Washington in terms of climatic conditions, vegetation, and landscape. In many regards, eastern Washington is more similar to Idaho and Montana than to western Washington, with its cold, snowy winters; hot, dry summers; strong winds; rugged mountain landscapes; high desert plateaus; rolling hills of wheat and fruit; lakes; and abundance of flat agricultural land.

This manual was developed to address conditions that are unique to eastern Washington with respect to designing stormwater BMPs such as the following:

- The Phase II Municipal Stormwater National Pollutant Discharge Elimination System Permit for eastern Washington requires retention of the 10-year stormwater runoff on-site, resulting in minimal discharge to municipal drainage systems. Some jurisdictions require retention of larger storms.
- Many developed sites in the region drain directly to underground injection control (UIC) wells.
- Storms generally occur as short-duration, high-intensity events.
- In some areas with intense agricultural use, ground water levels can fluctuate due to irrigation in the summer months, with reductions of several feet in the winter when irrigation is shut off.

Both this manual and the *Stormwater Management Manual for Western Washington* (SWMMWW) are based on the same standard: protecting water quality. However, consideration of the unique characteristics of eastern Washington such as those listed above has led to different approaches in the two manuals for selecting, sizing, and designing stormwater BMPs.

The BMPs in [Chapter 7 - Construction Stormwater Pollution Prevention](#) and [Chapter 8 - Source Control](#) of this manual (e.g., [BMP C120E: Temporary and Permanent Seeding](#)) have been designated with an “E” in the title to indicate that, while the BMP is provided in both manuals, the design guidance herein may have been revised to address eastern Washington conditions. The manuals are also organized differently, with this manual consisting of eight chapters and the SWMMWW consisting of five volumes. The eight Core Elements in this manual (see [Chapter 2 - Core Elements for New Development and Redevelopment](#)) include the same goals as the nine Minimum Requirements in the SWMMWW, but the organization is different.

## 1.2 How to Use This Manual

### 1.2.1 Applications of This Manual

The *Stormwater Management Manual for Eastern Washington* (manual) has applications for a variety of users. The Washington State Department of Ecology (Ecology) may approve other stormwater management manuals developed by local jurisdictions, the Washington State Department of Transportation (WSDOT), or other entities as being equivalent to this manual. Local jurisdictions may adopt and apply the requirements of this manual directly or adopt and apply the requirements of an equivalent manual (see [1.2.4 Alternative Technical Manuals](#)). Local jurisdiction staff may use this manual or an equivalent manual as a reference for reviewing Stormwater Site Plans (SSPs); for checking designs for source control, runoff treatment, and flow control Best Management Practices (BMPs); and for providing technical advice in general. Private industry may use the manual for information on how to develop and implement SSPs and as a reference for technical specifications BMPs.

The manual itself has no independent regulatory authority. The Core Elements and technical guidance in the manual become required only through:

- Ordinances and rules established by state and local jurisdictions, and
- Permits and other authorizations issued by local, state, and federal authorities. UIC Program rule requires new wells to design to the current manual.

Local jurisdictions may adopt and apply the Core Elements, thresholds, definitions, BMP selection processes, and BMP design criteria of this manual or an equivalent manual. Staff at local jurisdictions and agencies with permitting jurisdiction may use this manual in reviewing SSPs, checking BMP designs, and providing technical advice to project proponents.

Federal, state, and local permits may refer to this manual or the BMPs contained in this manual. In those cases, affected permit-holders or applicants should use this manual for specific guidance on how to comply with permit conditions.

### 1.2.2 Organization of This Manual

- [Chapter 1 - Introduction](#) explains the need for a technical stormwater management manual, what the manual is, and how the manual is intended to be used. It provides the regulatory framework for the manual.
- [Chapter 2 - Core Elements for New Development and Redevelopment](#) describes the



components of a successful stormwater management program. It provides the technical basis for eight Core Elements of stormwater management that are required for most projects and describes the conditions under which one or more Core Elements may or may not apply to a particular project.

Project proponents should start by reading [Chapter 2 - Core Elements for New Development and Redevelopment](#) of this manual, which explains the requirements of the Core Elements and defines how the Core Elements should be applied to individual projects and to particular levels of development.

For several of the Core Elements, thresholds are identified. These are the levels or conditions (e.g., project size or proposed land use) at or for which an action becomes required for that project. The thresholds presented in [Chapter 2 - Core Elements for New Development and Redevelopment](#) are technical thresholds. However, regulatory thresholds may be established in ordinances, rules, permits or other authorizations; these thresholds are not included in this manual but may modify certain thresholds that need to be met for a given project to comply with one or more Core Elements.

- [Chapter 3 - Preparation of Stormwater Site Plans](#) provides guidance for preparing the individual site plans upon which the success of each project activity in managing stormwater will depend.
- [Chapter 4 - Hydrologic Analysis and Design](#) identifies and describes the recommended methodologies for sizing and designing runoff treatment and flow control BMPs.
- [Chapter 5 - Runoff Treatment BMP Design](#) provides specific design information for runoff treatment BMPs, including infiltration treatment facilities and pretreatment facilities required for UIC program rule-authorized subsurface infiltration systems such as drywells.
- [Chapter 6 - Flow Control BMP Design](#) provides specific design information for flow control BMPs, including detention, retention, evaporation, dispersion, and infiltration systems.
- [Chapter 7 - Construction Stormwater Pollution Prevention](#) identifies and describes BMPs for short-term stormwater management at construction sites.
- [Chapter 8 - Source Control](#) identifies and describes BMPs for minimizing pollution generated by potential pollutant sources at developed sites.
- [References](#) includes the sources of information and references used in the preparation of the manual.
- The [Glossary](#) provides definitions of key terms and abbreviations used in the manual.

### **1.2.3 Stormwater Technical Manual**

This manual serves as a single technical stormwater manual for eastern Washington. It provides uniform stormwater management standards and is a central repository for BMPs. Ecology will maintain the region's technical stormwater manual for new development and redevelopment and will update, revise, and republish this manual as appropriate.

## **1.2.4 Alternative Technical Manuals**

Cities, counties, and other agencies may choose to develop alternative technical manuals. Those agencies and jurisdictions subject to state and federal regulatory programs that refer to this manual may be directed to submit their manuals to Ecology. The submittal must include an outline of significant differences between the manuals and demonstrate how the alternative manual is substantively equivalent to this manual. Ecology will work with jurisdictions to ensure that alternative manuals meet the regulatory objectives for which this manual is being required (e.g., protection of water quality). Where Ecology is uncertain that a local jurisdiction or agency requirement provides sufficient protection, it may provisionally approve the requirement. The provisions would require the local jurisdiction or agency to implement an approved monitoring effort to assess the performance of the local requirement. Jurisdictions and agencies choosing to develop alternative manuals may be directed to adopt this manual in the interim.

## **1.3 Effects of Urbanization**

### **1.3.1 Introduction to the Effects of Urbanization**

Managing stormwater may not seem necessary in arid and semiarid regions where rainfall is generally a welcomed event. However, the quality and habitat function of receiving waters in arid and semiarid climates are affected by pollutants carried by stormwater runoff and by the changes in the patterns of runoff from the land following development. Hydrologic and water quality changes caused by urbanization can result in irreversible changes to the biological systems that were supported by the natural hydrologic system.

### **1.3.2 Water Quality Changes**

Studies across the nation have found that urbanization causes increases in the types and quantities of pollutants in receiving waters. Regardless of the climatic setting, runoff from urban areas has been shown to contain many different types of pollutants, depending on the nature of the activities in those areas:

- The runoff from roads and highways is contaminated with pollutants from vehicles, and typical pollutants in road runoff include: oil and grease, polycyclic aromatic hydrocarbons (PAHs), lead, zinc, copper, cadmium, sediments (soil particles), and road salts and other anti-icing chemicals.
- Runoff from industrial areas typically contains even more types of heavy metals, sediments, and a broad range of organic pollutants, including phthalates, PAHs and other petroleum hydrocarbons. Industrial processes can also result in an increase in water temperature.
- Runoff from commercial areas contains concentrated road-based pollutant runoff and may also contain other pollutants typical of industrial and/or residential areas.
- Residential areas contribute the same road-based pollutants to runoff, as well as herbicides; pesticides; nutrients (from fertilizers and animal wastes); and bacteria, viruses and other pathogens (from animal wastes).

The pollutants in urban runoff can be dissolved in the water column or can be attached to solid particles that settle in streambeds, lakes, or wetlands. All of these contaminants can impair the beneficial uses of the receiving waters (both ground water and surface water). Metals are of particular concern for discharges to receiving waters due to the sensitivity of aquatic life to fairly low concentrations, especially copper and zinc. Pesticides and PAHs are of particular importance to discharges to ground water.

The pollutant concentrations in stormwater runoff from arid watersheds tend to be higher than that of humid watersheds, since rain events are infrequent and pollutants have more time to accumulate on impervious surfaces. Pervious areas in arid and semiarid regions also tend to produce higher sediment and organic carbon concentrations because the sparse vegetative cover does little to prevent soil erosion in uplands and along channels when it does rain. Event mean concentrations of selected pollutants in arid and semiarid regions are summarized by [\(Caraco, 2000\)](#).

[Table 1.1: Mean Concentrations of Selected Pollutants in Stormwater Runoff From Different Land Uses](#) from an analysis of Oregon urban runoff water quality monitoring data collected from 1990 to 1996 shows mean concentrations for a limited number of pollutants from different land uses.

**Table 1.1: Mean Concentrations of Selected Pollutants in Stormwater Runoff From Different Land Uses**

Land Use	Total Suspended Solids (mg/L)	Total Copper (µg/L)	Dissolved Copper (µg/L)	Total Zinc (µg/L)	Total Phosphorus (µg/L)
In-pipe industry	194	53	9	629	633
Instream industry	102	24	7	274	509
Transportation	169	35	8	236	376
Commercial	92	32	9	168	391
Residential	64	14	6	108	365
Open	58	4	4	25	166
Source: <a href="#">(Strecker et al., 1997)</a> mg/L = milligrams per liter µg/L = micrograms per liter					

**Note:** In [Table 1.1: Mean Concentrations of Selected Pollutants in Stormwater Runoff From Different Land Uses](#), *in-pipe industry* means the samples were taken in stormwater pipes. *Instream industry* means the samples were taken in streams flowing through industrial areas. Samples for all other categories were taken from within stormwater pipes.

In the state of Washington, the Washington State Department of Transportation (WSDOT) also collects and analyzes water quality data for highway stormwater runoff. The *WSDOT NPDES Municipal Stormwater Permit Final Highway Runoff Characterization Report* [\(WSDOT, 2015\)](#)

summarizes recent highway runoff monitoring data, showing measured pollutant loadings for five highway sites in rural, urbanized, and highly urbanized areas. This WSDOT report includes state-specific highway runoff pollutant concentrations for total suspended solids (TSS); fecal coliform bacteria; chloride; hardness; phosphorus; orthophosphate; nitrate-nitrite; total Kjeldahl nitrogen (TKN); total and dissolved copper, zinc, lead, and cadmium; total petroleum hydrocarbons (TPH), PAHs, and phthalates.

While instream dilution of the higher concentrations from any single project might prevent impairment of the beneficial uses of a water, capacity does not exist in most urban streams to dilute the discharges from all of the sources in the watershed, and the cumulative effect of all of the discharges in the watershed is much more likely to impair the beneficial uses of the receiving water.

Urbanization may also cause changes in water temperature. Stormwater heated from impervious surfaces and exposed treatment and detention ponds may be discharged to streams with less riparian vegetation for shade. Urbanization also reduces recharge of ground water—a source of cool water contributions to streamflows.

Regardless of the eventual land use conversion, the sediment load produced by a construction site can increase turbidity in the receiving water. Fine sediments can be deposited over the natural sediments of the receiving water and degrade fish spawning areas and instream habitat for other aquatic life.

This manual provides guidance on runoff treatment practices for reducing the impacts of pollutant-laden stormwater from individual sites through source control, construction stormwater pollution prevention, and runoff treatment Best Management Practices (BMPs). [1.5.2 Source Control BMPs](#) provides the background of developing source control BMPs; [2.7.4 Core Element #3: Source Control of Pollution](#) defines the requirements for applying these BMPs. [1.5.3 Runoff Treatment BMPs](#) provides the background for developing runoff treatment BMPs; [2.7.6 Core Element #5: Runoff Treatment](#) defines the requirements for applying these BMPs. [2.7.3 Core Element #2: Construction Stormwater Pollution Prevention](#) and all of [Chapter 7 - Construction Stormwater Pollution Prevention](#) are devoted to construction stormwater pollution prevention.

### **1.3.3 Hydrologic Changes**

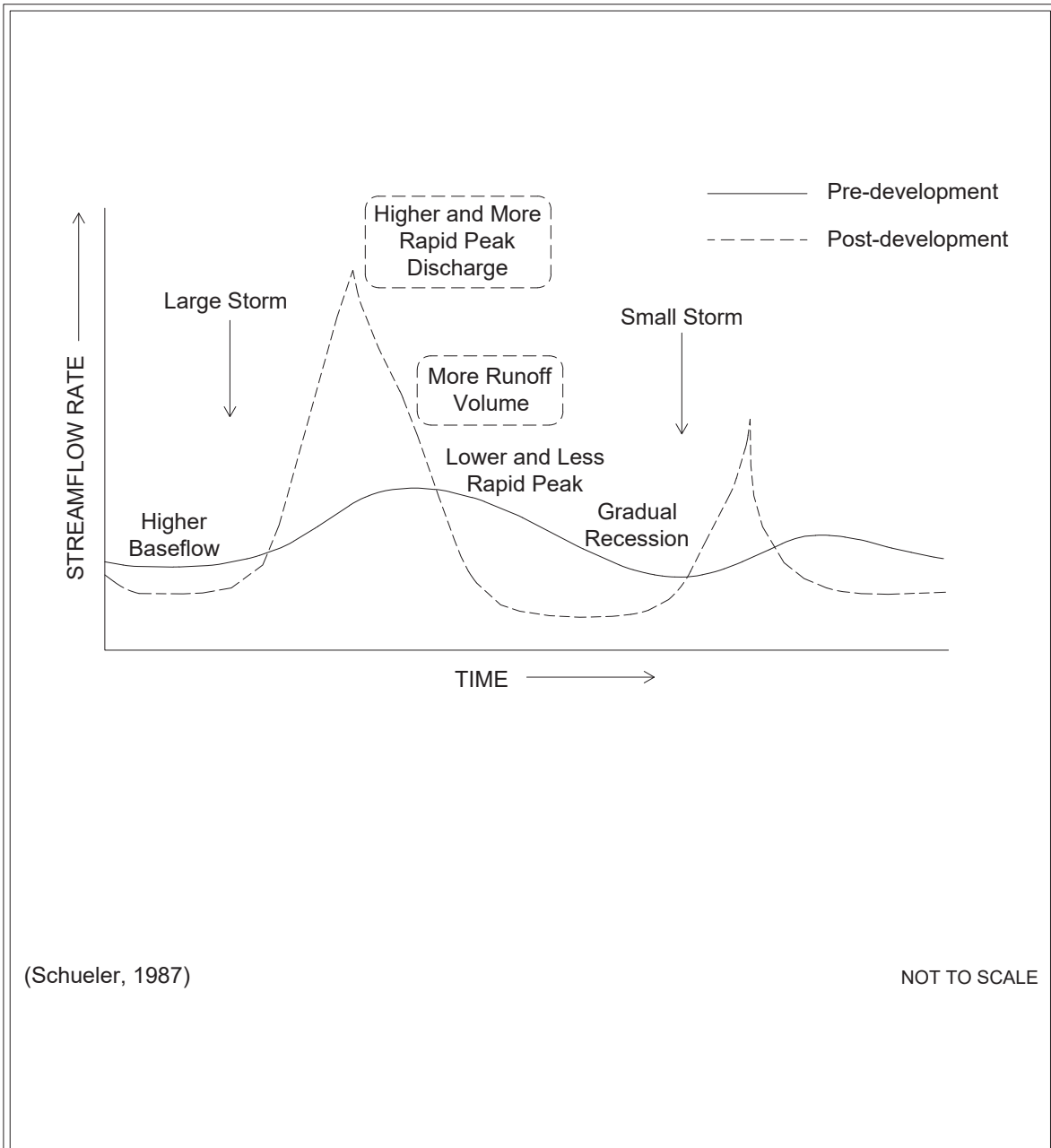
Just as the landscape of eastern Washington includes prairies, pine forests, the shrub-steppe, channeled scablands, and vast areas of irrigated and dryland agriculture, the hydrology of streams in eastern Washington varies tremendously. Average annual precipitation varies from 6 inches to > 60 inches. Streambed material varies from basalt rock to highly erodible loess soils. Many streams flow only during the relatively wet winter and spring seasons or only during a runoff-producing rainstorm or snowmelt event. The hydrology of other streams has been altered by seasonal irrigation practices.

Regardless of the hydrologic and geologic setting, streams can be impacted by urbanization of their watersheds. As development occurs, land is cleared and impervious surfaces such as roads, parking lots, rooftops, and sidewalks are added. Roads are cut through slopes and low spots are filled. The natural soil structure is lost due to grading and compaction during construction. Drainage patterns are irrevocably altered. Maintained landscapes that have much higher runoff characteristics often replace the native vegetation. The accumulation of these changes may affect the natural hydrology by means of the following actions:

- Increasing the peak flow rates of runoff
- Increasing the total volume of runoff
- Decreasing the time it takes for runoff to reach a natural receiving water
- Increasing stream velocities
- Reducing ground water recharge
- Increasing the frequency and duration of high streamflows
- Increasing inundation of wetlands during and after wet weather
- Reducing streamflows and wetland water levels during the dry season

[Figure 1.2: Changes in Hydrology After Development](#) illustrates some of these hydrologic changes. As a consequence of these changes in hydrology, stream channels may experience both increased flooding and reduced base flows. Natural riffles, pools, gravel bars, and other areas may be altered or destroyed. Increased channel erosion, loss of hydraulic complexity, degradation of habitat, and changes in the composition of species present in receiving waters may follow.

**Figure 1.2: Changes in Hydrology After Development**



(Schueler, 1987)

NOT TO SCALE



## Changes in Hydrology Following Development

Revised June 2016

Please see <http://www.ecy.wa.gov/copyright.html> for copyright notice including permissions, limitation of liability, and disclaimer.

These changes do not result from any one project; they are the cumulative effect of all of the development in a watershed.

From a stream morphology standpoint, smaller flood events that approximate bankfull conditions and occur naturally every year or two (1.5- to 2-year frequency) are the most influential discharges and most easily changed with added urban runoff. It is these smaller flood events that shape the channel and are referred to as “effective flows” because over time they move the most sediment and transform the dimensions of a stream channel. When effective flows increase in size, duration, and frequency, the most common impact is changes in channel morphology to accommodate the rise in erosive energy delivered to receiving streams on an annual basis.

Research in streams in arid, semiarid, and humid climate settings has shown that this accommodation commonly takes place by widening and down cutting of the streambed, damaging habitats and potentially reducing biologic diversity. Research has shown that as developed impervious areas reach 5% of land cover within a watershed, the connection between runoff from impervious areas and channel response through erosion begins to occur ([\(Hajda et al., 1999\)](#); [\(Hollis, 1975\)](#); and [\(Booth, 1991\)](#)).

The intent of flow control is to prevent increases in the stream channel erosion rates that are characteristic of natural conditions by releasing runoff from the proposed development condition in a manner that delivers approximately the same amount of erosive energy to the stream as it received under predeveloped or receives under existing conditions.

Flow control in this manual is targeted to smaller water bodies, especially first to third order streams or water bodies with contributing watershed areas of less than 100 square miles. These streams are most susceptible to changes in runoff patterns caused by development. In larger water bodies, the location of the development activity plays a greater role: in general, development that occurs nearer to a large stream channel and that does not encroach on the natural floodplain has less of an effect than development activities in the upper watershed, which are instead likely to impact smaller tributary stream channels.

This manual includes guidance on stormwater management practices for controlling excess runoff volume from individual sites through flow control BMPs. [1.5.4 Flow Control BMPs](#) provides the background of developing these BMPs; [2.7.7 Core Element #6: Flow Control](#) defines the requirements for applying these BMPs.

## **1.4 Relationship of This Manual to Federal, State, and Local Regulatory Requirements**

### **1.4.1 Introduction to the Relationship of This Manual to Federal, State, and Local Regulatory Requirements**

The *Stormwater Management Manual for Eastern Washington* (manual) is one tool in the efforts to manage and reduce the impacts of urban stormwater discharges. At the date of publication of this manual, several regulatory programs and permits exist that may directly or indirectly require a project proponent to properly manage stormwater.

## 1.4.2 Applicable Federal and State Regulations

The federal Clean Water Act, the federal Safe Drinking Water Act, and the state Water Pollution Control Act ([Chapter 90.48 RCW](#)) are the primary federal and state regulations that directly apply to management of stormwater discharges. These laws are aimed at protecting water quality by controlling the amount of pollutants discharged to surface and ground waters. Other regulatory programs such as the federal Endangered Species Act and state Hydraulics Act also commonly require project proponents to properly manage stormwater to protect water quality and habitat. Specific permitting programs and other situations where stormwater management may be required by law are detailed in the following sections.

## 1.4.3 NPDES and State Waste Discharge Stormwater Permits for Municipalities

In Washington State, the cities of Seattle and Tacoma; King, Pierce, Snohomish, and Clark counties; and the Washington State Department of Transportation facilities within those jurisdictions have been subject to U.S. Environmental Protection Agency (U.S. EPA) National Pollutant Discharge Elimination System (NPDES) Phase I Stormwater Regulations ([40 CFR Part 122](#)). The U.S. EPA adopted NPDES Phase II stormwater regulations in December 1999. Those rules identify additional operators of regulated small municipal separate storm sewer systems (MS4s) as subject to NPDES municipal stormwater permitting requirements.

The Phase II Municipal Stormwater National Pollutant Discharge Elimination System (NPDES) Permit for eastern Washington (Municipal Stormwater Permit) was first issued by Ecology in February 2007. The cities and counties subject to the Municipal Stormwater Permit requirements in eastern Washington are listed on the Washington State Department of Ecology's (Ecology's) Municipal Stormwater General Permits web page at the following web address:

<https://ecology.wa.gov/Regulations-Permits/Permits-certifications/Stormwater-general-permits/Municipal-stormwater-general-permits>

The federal regulations specify minimum measures for municipal stormwater programs for compliance with the Phase II rules. One of those measures is the adoption of a program for post-construction stormwater management for new development and redevelopment. Another is a program for construction site stormwater runoff control.

This manual provides technical guidance for projects to comply with municipal stormwater requirements in these two areas. Local jurisdictions covered under the Municipal Stormwater Permit must apply this manual or an approved equivalent to their own capital improvement and other public works projects. All local jurisdictions should work to identify and prioritize stormwater management actions that will effectively protect local water quality.

In Washington State under [Chapter 90.48 RCW](#), all permits for discharges of pollutants apply to waters of the state, including discharges to ground water and discharges to receiving waters. Jurisdictions applying for coverage under the Municipal Stormwater Permit will receive a combined NPDES State Waste Discharge Permit. Where there are existing regulatory programs that address discharges to ground water, Ecology defers to those programs rather than duplicating or adding new requirements.



For discharges to ground water that are covered under the Underground Injection Control (UIC) program (see [1.4.6 Underground Injection Control Program](#) and [5.6 Subsurface Infiltration \(Underground Injection Control Wells\)](#)), Ecology defers to the UIC program for the control of those discharges and does not regulate those discharges under the Municipal Stormwater Permit.

### **1.4.4 Industrial Stormwater General Permit**

Facilities covered under Ecology’s Industrial Stormwater General Permit (ISGP), i.e., NPDES and State Waste Discharge General Permit for Stormwater Discharges Associated With Industrial Activities, must manage stormwater in accordance with specific terms and conditions including the development and implementation of an Industrial Stormwater Pollution Prevention Plan (Industrial SWPPP), monitoring, reporting, and ongoing adaptive management based on sampling and inspections.

The ISGP requires Industrial SWPPPs to include certain mandatory Best Management Practices (BMPs), including those BMPs identified as “applicable” to specific industrial activities in [Chapter 5 - Runoff Treatment BMP Design](#) and [Chapter 8 - Source Control](#) of this manual. Facilities with new development or redevelopment must evaluate whether flow control BMPs are necessary. BMPs must be consistent with this manual, or other stormwater management guidance documents that are approved by Ecology and incorporated into the ISGP. Facilities may also use alternative BMPs if their Industrial SWPPP includes documentation that the BMPs selected are demonstrably equivalent to practices contained in stormwater technical manuals approved by Ecology, including the proper selection, implementation, and maintenance of all applicable and appropriate BMPs for on-site pollution control.

Ecology’s Industrial Stormwater web page has a fill-in-the-blank Industrial SWPPP template for use by industrial facilities. See the following website:

<http://ecology.wa.gov/Regulations-Permits/Permits-certifications/Stormwater-general-permits/Industrial-stormwater-permit>

ISGP facilities are required to update their Industrial SWPPPs and perform corrective actions if stormwater monitoring results exceed “benchmark” or indicator values. Facilities that trigger corrective actions under the ISGP, or otherwise need to update their SWPPP, should consider the following:

- “Recommended” operational and structural source control BMPs listed in [Chapter 8 - Source Control](#)
- Runoff treatment BMPs listed in [Chapter 5 - Runoff Treatment BMP Design](#)
- Erosion and sediment control BMPs listed in [Chapter 7 - Construction Stormwater Pollution Prevention](#) (e.g., if turbidity, sediment, or associated pollutants need to be addressed)
- Runoff treatment BMPs that have been evaluated through the Technology Assessment Protocol–Ecology (TAPE) or the Chemical Technology Assessment Protocol–Ecology (CTAPE) programs. Refer to the following website for more information:

<https://ecology.wa.gov/Regulations-Permits/Guidance-technical-assistance/Stormwater->

[permittee-guidance-resources/Emerging-stormwater-treatment-technologies](#)

- BMPs that are “demonstrably equivalent,” as defined by the ISGP

### **1.4.5 Construction Stormwater General Permit**

Operators of construction activities are required to seek coverage under the Construction Stormwater General Permit (CSWGP) if the activities entail clearing, grading and excavation that results in the disturbance of 1 acre or more (including off-site disturbance acreage authorized in S1.C.2) and discharge stormwater to surface waters of the state or to a conveyance system that drains to surface waters of the state. Smaller project sites may also require coverage if they are part of a larger common plan of development or sale, if the common plan of development or sale will ultimately disturb 1 or more acres and discharge stormwater to surface waters of the state.

The CSWGP requires the development and implementation of a SWPPP. The SWPPP must detail the various BMPs that will be used during construction to prevent erosion and sedimentation that could impact downstream water quality. [Chapter 7 - Construction Stormwater Pollution Prevention](#) may be used by project proponents and others in the development of the SWPPP and in the selection, design, and application of erosion and sediment runoff control BMPs.

### **1.4.6 Underground Injection Control Program**

One of the provisions of the federal Safe Drinking Water Act is to protect underground sources of drinking water (USDW). In 1984, Ecology received authority from the U.S. EPA to administer the Underground Injection Control (UIC) Program to protect USDW by regulating the discharges of fluids into the subsurface by UIC wells.

Ecology adopted [Chapter 173-218 WAC](#) to implement the program; however, the UIC program rule protects all ground water, not just USDW. The U.S. EPA organizes UIC wells into six classes. The Washington UIC program regulates Class I through Class V UIC wells, except for wells located on tribal land. UIC wells used to manage stormwater are considered Class V wells. For more information, visit Ecology’s web page for the UIC program at the following address:

<https://ecology.wa.gov/Regulations-Permits/Guidance-technical-assistance/Underground-injection-control-program>

The UIC program has two requirements:

1. A non-endangerment performance standard must be met, prohibiting discharges that allow movement of fluids containing contaminants to reach the ground water.
2. All UIC facility owners/operators must complete online UIC well registration with Ecology.

The UIC program defines a UIC well as a well that is used to discharge fluids from the ground surface into the subsurface and is one of the following:

1. A bored, drilled or driven shaft, or dug hole whose depth is greater than the largest surface dimension; or
2. A dug hole whose depth is greater than the largest surface dimension, or
3. An improved sinkhole; which is a natural crevice that has been modified, or

4. A subsurface fluid distribution system which includes perforated pipes, drain tiles or other similar mechanisms intended to distribute fluids below the surface of the ground.

Examples of UIC wells or subsurface infiltration systems are the following:

1. Drywells
2. Drain Fields
3. Infiltration trenches with perforated pipe
4. Storm chamber systems with the intent to infiltrate
5. French Drains
6. Bioretention systems intending to infiltrate water from a perforated pipe below the treatment soil
7. Other similar devices that discharge to ground

The following are not UIC wells:

- Buried pipe and/or tile networks that serve to collect water and discharge that water to a drainage system or to a receiving water
- Surface infiltration basins and flow dispersion stormwater facilities
- Infiltration trenches designed without perforated pipe or a similar mechanism
- Bioretention systems transporting water via a perforated pipe to a drainage system or to a receiving water

Depending upon the manner in which it is accomplished, the discharge of stormwater into the ground can be classified as a Class V injection well, and must therefore comply with Ecology's UIC Program.

The UIC rule ([Chapter 173-218 WAC](#)) applies to all Class V UIC wells that receive stormwater discharges. These wells must be sited, designed, constructed, managed, operated and maintained according to the requirements throughout [5.6 Subsurface Infiltration \(Underground Injection Control Wells\)](#).

If all stormwater runoff from the project site discharges to a Class V UIC well, the Municipal Stormwater Permits do not pertain to the project, and the Core Elements do not apply. The UIC rule ([Chapter 173-218 WAC](#)) applies in such cases. See [5.6 Subsurface Infiltration \(Underground Injection Control Wells\)](#) for details on the rules, registration requirements, regulations, non-endangerment standard, treatment requirements, and operation guidelines.

### **1.4.7 Endangered Species Act**

Project proponents planning to discharge stormwater into bodies of water that provide habitat for threatened or endangered species are expected to properly manage their stormwater. Contact the appropriate federal agencies (e.g., the National Oceanic and Atmospheric Administration's National

Marine Fisheries Service, or the U.S. Fish and Wildlife Service) to determine whether this manual may be used to satisfy federal Endangered Species Act requirements.

### **1.4.8 Section 401 Water Quality Certifications and Section 404 Permits**

Issuance of a Section 401 Certification means that Ecology has reasonable assurance that the applicant's project will comply with state water quality standards and other aquatic resources protection requirements under Ecology's authority. The Section 401 Certification can cover both the construction and operation of a proposed project.

[Section 404 of the Clean Water Act](#) establishes a program to regulate the discharge of [dredged](#) or [fill](#) material into [waters of the United States](#), including wetlands. Activities in waters of the United States regulated under this program include fill for development, water resource projects (such as dams and levees), infrastructure development (such as highways and airports) and mining projects.

For 404 permits, the U.S. Army Corps of Engineers (USACE) has developed Nationwide Permits to streamline the process for specific activities. USACE reviews a proposed project to determine if an individual Section 404 permit is required, or if the project can be authorized under a Nationwide Permit. The Nationwide Permits also need Section 401 Certification from Ecology.

In order to evaluate a project for Section 401 Certification, Ecology may conduct a specific review of the potential impacts of a stormwater discharge from the construction phase of the project and from the completed project. As a result of that review, Ecology may condition its Section 401 Certification to require the application of one or the other of the following:

- The Core Elements and BMPs in this manual
- More stringent requirements

### **1.4.9 Hydraulic Project Approvals**

Under the Hydraulics Act ([Chapter 77.55 RCW](#)), the Washington Department of Fish and Wildlife (WDFW) has the authority to require actions when stormwater discharges related to a project would change the natural flow or bed of state waters. The implementing mechanism is the issuance of a Hydraulics Project Approval permit. In exercising this authority, WDFW may require one or the other of the following:

- Compliance with the provisions of this manual
- Application of more stringent requirements that WDFW determines are necessary to meet the jurisdiction's statutory obligations to protect fish and wildlife

### **1.4.10 Aquatic Lands Use Authorizations**

The Washington State Department of Natural Resources (DNR), as the steward of public aquatic lands, may require a stormwater outfall to have a valid use authorization and to avoid or mitigate impacts to natural resources. Through its use authorizations, which are issued under authority of [RCW 79.105-79.140](#), and in accordance with [Chapter 332-30 WAC](#), DNR may require one or the other of the following:

- Compliance with the provisions of this manual
- Application of more stringent requirements that DNR determines are necessary to meet the jurisdiction's statutory obligations to protect the quality of the state's aquatic lands.

### **1.4.11 Requirements Identified Through Watershed/Basin Planning or Total Maximum Daily Loads**

A number of the requirements of this manual can be superseded by the adoption of ordinances and rules to implement the recommendations of watershed plans or basin plans. Local jurisdictions may initiate their own watershed or basin planning processes to identify more stringent or alternative requirements. They may choose to develop a watershed plan in accordance with the Watershed Management Act ([Chapter 90.82 RCW](#)) that includes the optional elements of water quality and habitat. As long as the actions or requirements identified in those plans and implemented through local or state ordinances or rules comply with applicable state and federal regulations (e.g., the federal Clean Water Act and Endangered Species Act), they can supersede the requirements in this manual. The decisions concerning whether locally derived requirements comply with federal and state statutes rest with the regulatory agencies responsible for implementing those statutes.

Any requirement of this manual may also be superseded or added to through the adoption of actions and requirements identified in a Total Maximum Daily Load (TMDL) that is approved by the U.S. EPA. However, it is likely that many TMDLs will require use of the BMPs in this manual.

### **1.4.12 WSDA Pesticide Regulations**

The Washington State Department of Agriculture (WSDA) administers pesticide laws, under the Washington Pesticide Control Act ([Chapter 15.58 RCW](#)), the Washington Pesticide Application Act ([Chapter 17.21 RCW](#)), and regulations under [Chapter 16-228 WAC](#). The requirements relevant to water quality protection are as follows:

- Licenses are required for persons who apply pesticides except for the following:
  - People who use general-use pesticides on their own or their employer's property
  - Grounds maintenance people using only general-use pesticides on an occasional basis not amounting to a regular occupation
  - Governmental employees who apply general-use pesticides without using any kind of motorized or pressurized apparatus
  - Employees of a commercial applicator or a government agency who are under direct on-site supervision by a licensed applicator
- Licensed applicators must undergo 40 hours of continuing education to keep their license.
- No person shall pollute streams, lakes, or other water supplies while loading, mixing or applying pesticides.
- No person shall transport, handle, store, load, apply, or dispose of any pesticide, pesticide

container, or apparatus in such a manner as to pollute water supplies or receiving waters or cause damage or injury to land, including humans, desirable plants, and animals.

## **1.4.13 Stormwater Discharges to Public Sanitary Sewers, Septic Systems, Dead-End Sumps, and Industrial Waste Treatment Systems**

### ***Stormwater Discharges to Sanitary Sewers***

Discharging stormwater to a public sanitary sewer is normally prohibited, as this tends to overload the sewage treatment plant during storm events when flows are already high. Direct discharge of relatively uncontaminated or treated stormwater from businesses typically poses less of a threat to the environment than pass through of solids due to “wash out” at the sewage treatment plant during storm events. Such discharges require the approval of the local sewer authority if Ecology has delegated the authority to set pretreatment requirements. If the sewer authority has not received such authority, the business or public agency that wishes to discharge stormwater to the sanitary sewer must also apply for a State Waste Discharge Permit.

In setting pretreatment requirements, the local sewer authority or Ecology must operate within state regulations ([Chapter 173-216 WAC](#)), which in turn must comply with federal regulations ([40 CFR 403.5](#)). These regulations specifically prohibit discharge of any of the following:

- Materials that pass through the municipal treatment plant untreated or interfere with its operation
- Materials that create a fire or explosion hazard, including, but not limited to, waste-streams with a closed cup flash point of less than 140 degrees Fahrenheit (°F) or 60 degrees Celsius (°C) using the test methods specified in [40 CFR 261.21](#)
- Materials that will cause corrosive structural damage to the publicly owned treatment works (POTW) but in no case with pH lower than 5.0 or greater than 11, unless the POTW is specifically designed to accommodate such discharges and the discharge is authorized by a permit issued under [Chapter 173-216 WAC](#). See [WAC 173-216-060\(2\)\(iv\)](#).
- Solid or viscous pollutants in amounts that will cause obstruction to the flow in the POTW, resulting in interference
- Heat in amounts that will inhibit biological activity in the POTW resulting in interference but in no case heat in such quantities that the temperature at the POTW exceeds 40°C (104°F) unless the system is specifically designed to accommodate such discharge and the discharge is authorized by a permit under [Chapter 173-216 WAC](#). See [WAC 173-216-060\(2\)\(v\)](#).
- Petroleum oil, nonbiodegradable cutting oil, or products of mineral oil origin in amounts that will cause interference or pass through the treatment plant
- Pollutants that result in the presence of toxic gases, vapors, or fumes within the POTW in a quantity that may cause acute worker health and safety problems
- Any trucked or hauled pollutants, except at discharge points designated by the POTW
- Any discharge which would violate the dangerous waste regulations, [Chapter 173-303 WAC](#).

See [WAC 173-216-060\(1\)](#).

- Any of the following discharges, unless approved by the local sewer authority or Ecology under extraordinary circumstances, such as lack of direct discharge alternatives due to combined sewer service or need to augment sewage flows due to septic conditions. See [WAC 173-216-060\(2\)\(vii\)](#):
  - Noncontact cooling water in significant volumes
  - Stormwater and other direct inflow sources
  - Wastewater significantly affecting system hydraulic loading, which does not require treatment or would not be afforded a significant degree of treatment by the system

Discharges of stormwater authorized under [Chapter 173-216 WAC](#), typically limit flows entering the sanitary sewer based on the available hydraulic capacity of the collection system or the treatment plant by the combined flow of sanitary sewage and stormwater. The allowable concentrations of particular materials such as metals and grease vary with the particular sewer system. Discharges must comply with all local jurisdiction limits. Contact both the POTW and the regional water quality program to find out what discharge limits apply to a particular sewerage system.

### ***Stormwater Discharges to an Industrial Waste Treatment System***

Operators may process treatment to dispose of polluted stormwater depending on the NPDES Permit constraints of the particular business.

### ***Stormwater Discharges to Dead-End Sumps***

Do not discharge substances that cause a violation of water quality standards to a septic system, receiving water, or ground water. If a sanitary or industrial wastewater treatment system is not available, an alternative is the use of a dead-end sump. Sumps are tanks with drains that can be periodically pumped for appropriate disposal. Depending on the composition of the waste, it may or may not be considered Dangerous Waste.

For more information on disposal requirements for sumps, see *Step by Step Fact Sheet for Hazardous Waste Generators* ([Ecology, 2003](#)).

## **1.4.14 Other Local Jurisdiction Requirements**

Local jurisdictions have the option of applying more stringent requirements than those in this manual. For example, local jurisdiction critical areas or grading codes, watershed/basin plans, Flood Hazard Management Plans, or TMDLs could provide additional or more stringent requirements for managing stormwater runoff. Project proponents should always check with the local jurisdiction to determine the stormwater requirements that apply to their project.

Jurisdictions may have interconnected systems. Neighboring jurisdictions are encouraged to work together to establish consistent design criteria for stormwater facilities since the climatic, geologic, and hydrologic variation among neighboring jurisdictions is likely to be minimal. Where MS4s and/or combined sewer systems are interconnected between jurisdictions with different requirements, the downstream jurisdiction's requirements apply.

## **1.4.15 Local Jurisdiction Role in Implementing State/Federal Permit Requirements and Programs**

Due to their knowledge and understanding of local water bodies, relationships with local businesses, and proximity to project sites, local jurisdictions can play an important role in implementing and enforcing permits and programs such as construction and industrial stormwater permits and the UIC program. Ecology is ultimately responsible for implementation of these and other permits and programs in Washington State, but recognizes that these programs can have only limited success without the support and assistance of local jurisdictions.

Specific suggested “Responsibilities of Local Jurisdictions” are highlighted in [2.6 Redevelopment](#) and in each Core Element in [2.7 Core Elements](#). These sections are provided as guidance for jurisdictions that are planning programmatic activities to manage stormwater to protect local water quality. A few of these potential roles may be further defined through the UIC rule revision and the Phase II municipal stormwater permitting process for those jurisdictions. But in most cases, Ecology simply hopes to develop and maintain a cooperative working relationship with the local jurisdiction and focus limited resources on sites with the greatest potential to impact water quality.

## **1.5 Development Of Best Management Practices for Stormwater Management**

### **1.5.1 Best Management Practices**

The method by which the Stormwater Management Manual for Eastern Washington (manual) mitigates the adverse impacts of development and redevelopment is through the application of Best Management Practices (BMPs). The BMPs included in this manual have been approved by the Washington State Department of Ecology (Ecology); as new technologies are evaluated and approved, additional BMPs will be published as updates to this manual.

BMPs are defined as schedules of activities, prohibitions of practices, structural facilities, maintenance procedures, and/or managerial practices that when used singly or in combination, prevent or reduce the release of pollutants and other adverse impacts to waters of Washington State. The categories of BMPs include source control, runoff treatment, flow control, and construction stormwater BMPs.

The primary purpose of using BMPs is to protect the beneficial uses of water resources through prevention of contamination, through the reduction of pollutant concentrations and loads, through reduction of peak flow rates causing stream channel erosion, and through reduction in deviations from natural hydrology. If it is found that, after the implementation of BMPs advocated in this manual, beneficial uses are still threatened or impaired, additional controls may be required.

### **1.5.2 Source Control BMPs**

Source control BMPs typically prevent pollution or other adverse effects on stormwater. Ecology further classifies source control BMPs as operational or structural. Some examples of source control BMPs include sweeping, using mulches and covers on disturbed soil, constructing roofs over outside storage areas, and berming areas to prevent stormwater run-on and pollutant runoff.



It is generally more cost-effective to use source controls to prevent pollutants from entering runoff than to treat runoff to remove pollutants. However, since source controls cannot prevent all impacts some combination of measures will typically be needed.

[2.7.4 Core Element #3: Source Control of Pollution](#) defines the requirements for applying these BMPs; and [Chapter 8 - Source Control](#) describes the procedures for implementing these BMPs.

### **1.5.3 Runoff Treatment BMPs**

Runoff treatment BMPs remove pollutants by simple gravity settling of particulate pollutants, centrifugal separation, filtration, biological uptake, and media or soil adsorption. The need for a project to provide runoff treatment BMPs depends on (1) the type and amount of pollutants expected to be generated by the completed project and (2) the vulnerability of the receiving waters to the pollutants of concern. A combination of BMPs may be required to protect the receiving waters.

Runoff treatment BMPs can accomplish significant levels of pollutant load reductions if properly designed, constructed/implemented, and maintained.

It is not generally practical to treat 100% of the annual stormwater runoff volume generated by a project site. Some of the design specifications for runoff treatment BMPs in this manual are established such that the BMPs are presumed to treat at least 90% of the total average annual runoff volume; this amount is considered to be a reasonable goal for capturing as many contaminants as practicable. Other BMP design specifications are based on treating the “first flush” of each storm event: stormwater produced by first rainstorm following a dry period during which pollutants have accumulated on impervious surfaces is commonly believed to carry a majority of the pollutants in urban runoff.

[2.7.6 Core Element #5: Runoff Treatment](#) defines the requirements for applying these BMPs; and [Chapter 4 - Hydrologic Analysis and Design](#) and [Chapter 5 - Runoff Treatment BMP Design](#) describe the design criteria and procedures for implementing these BMPs.

### **1.5.4 Flow Control BMPs**

Flow control BMPs typically control the volume, flow rate, frequency, and flow duration of stormwater runoff. Excess stormwater runoff volumes are generally managed by use of infiltration, evaporation, or detention BMPs. On-site infiltration is the preferred means of disposing of stormwater runoff where feasible, generally in areas with relatively permeable soils where high ground water is not an issue. With the lower amounts of runoff in the arid and semiarid climate of eastern Washington, infiltration may be feasible in many areas across the region.

The goals for flow control vary depending on whether the project site discharges to a stream channel, lake, or wetland, as follows:

- Stream Channels – To protect stream channels from increased erosion, it is necessary to control the durations over which a stream channel experiences geomorphically significant flows such that the energy imparted to the stream channel does not increase significantly. Geomorphically significant flows are those that are capable of moving sediments. On-site infiltration is an excellent way of reducing the duration of erosive flows where infiltration is feasible. See [2.7.7 Core Element #6: Flow Control](#), Application to Nonexempt Streams and Lakes, for additional information.

- Lakes – The goal is to protect the outlet stream channel, as described above. See [2.7.7 Core Element #6: Flow Control](#), Application to Nonexempt Streams and Lakes, for additional information.
- Wetlands – The goal is to not alter the natural hydroperiod. This requires the control of input flows such that the wetland is within certain elevations at different times of the year and that short-term elevation changes are within the desired limits. If the amount of stormwater runoff to a wetland is increased because of land conversion from native vegetation to impervious areas, it may be necessary to bypass some water around the wetland in the wet season. Bypassed stormwater must still meet flow control and runoff treatment requirements applicable to the receiving water. If however, the wetland was fed by local ground water elevations during the dry season, the impervious surface additions and the bypassing practice may cause variations from the dry season elevations. See [2.7.7 Core Element #6: Flow Control](#), Applicability to Wetlands, and Ecology’s wetland regulation and permitting resources at the following web page for additional information:

<https://ecology.wa.gov/Water-Shorelines/Wetlands/Regulations>

[2.7.7 Core Element #6: Flow Control](#) defines the requirements for applying these BMPs; and [Chapter 4 - Hydrologic Analysis and Design](#) and [Chapter 6 - Flow Control BMP Design](#) describe the design criteria and procedures for implementing these BMPs.

### **1.5.5 Construction Stormwater BMPs**

Construction stormwater BMPs can be source control, runoff treatment, or flow control BMPs. Examples include [BMP C105E: Stabilized Construction Access](#), [BMP C233E: Silt Fence](#), [BMP C207E: Check Dams](#), and [BMP C240E: Sediment Trap](#). [2.7.3 Core Element #2: Construction Stormwater Pollution Prevention](#) defines the requirements for applying these BMPs; and [Chapter 7 - Construction Stormwater Pollution Prevention](#) describes the design criteria and procedures for implementing these BMPs.

### **1.5.6 New and Emerging BMPs**

Ecology encourages the development and implementation of new approaches to managing and treating stormwater. This manual is intended to be a living document, and project proponents should check Ecology’s website for additional BMPs that have been approved since the publication of this manual. More information is provided in [5.11 Emerging Technologies](#) about the statewide Technology Assessment Protocol–Ecology (TAPE) for testing new and emerging stormwater management technologies.

# Chapter 2 - Core Elements for New Development and Redevelopment

## 2.1 Introduction

This chapter identifies and defines the eight Core Elements of stormwater management. These Core Elements are applicable to new development and redevelopment projects in eastern Washington that meet the regulatory threshold of the Phase II Municipal Stormwater National Pollutant Discharge Elimination System (NPDES) Permit for eastern Washington (Municipal Stormwater Permit).

Not all Core Elements apply to every project and, depending on the type and size of a project, different combinations of the eight Core Elements may apply. For project sites that discharge all stormwater runoff to a Class V underground injection control (UIC) well, none of the eight Core Elements applies since UIC wells are not covered under the Municipal Stormwater Permit; however, the proponent still needs to provide a Stormwater Site Plan, implement construction stormwater pollution prevention best management practices (BMPs), and needs to apply source control. The proponent may also need to provide treatment prior to discharging runoff to a UIC well depending on the unsaturated zone and the depth to a confining layer or ground water. See [1.4.6 Underground Injection Control Program](#) for a discussion of the UIC program and [5.6 Subsurface Infiltration \(Underground Injection Control Wells\)](#) for design guidance, rules, and requirements pertaining to UIC well siting, design, operation and maintenance, and registration. For project sites that discharge only a portion of the stormwater runoff to a Class V UIC well, some combination of the eight Core Elements may apply on the basis of the guidelines and thresholds provided in this chapter.

See also [1.3 Effects of Urbanization](#) for the regulatory framework and conditions under which the manual may be required for various projects and [1.1.4 Presumptive Versus Demonstrative Approaches to Protecting Water Quality](#) for a description of using a demonstrative approach to protecting water quality in lieu of following this manual. Best Management Practices (BMPs) for implementing the Core Elements are described in [Chapter 5 - Runoff Treatment BMP Design](#), [Chapter 6 - Flow Control BMP Design](#), [Chapter 7 - Construction Stormwater Pollution Prevention](#), and [Chapter 8 - Source Control](#). Specific project exemptions are listed in [2.2 Exemptions](#) and [2.3 Partial Exemptions](#). See the [Glossary](#) for definitions of key words and phrases used in this section.

The Core Elements are as follows:

- [2.7.2 Core Element #1: Preparation of a Stormwater Site Plan](#)
- [2.7.3 Core Element #2: Construction Stormwater Pollution Prevention](#)
- [2.7.4 Core Element #3: Source Control of Pollution](#)
- [2.7.5 Core Element #4: Preservation of Natural Drainage Systems](#)
- [2.7.6 Core Element #5: Runoff Treatment](#)
- [2.7.7 Core Element #6: Flow Control](#)

- [2.7.8 Core Element #7: Operation and Maintenance](#)
- [2.7.9 Core Element #8: Local Requirements](#)

The purpose and applicability of each of these Core Elements is described in detail in [2.7 Core Elements](#). Project proponents need to be familiar with the contents of [Chapter 2 - Core Elements for New Development and Redevelopment](#) in order to determine which Core Elements apply to a given project.

Guidelines and supplemental guidelines are provided in [2.6 Redevelopment](#), and in [2.7 Core Elements](#). The guidelines must be followed for a project to comply with the stormwater management provisions set forth in this manual. The supplemental guidelines are optional and are included for special circumstances. These supplemental guidelines may be required in certain jurisdictions. See [2.7.9 Core Element #8: Local Requirements](#) for local jurisdiction requirements.

For each Core Element in [2.7 Core Elements](#), the section Recommendations for Local Jurisdictions is provided as guidance for jurisdictions that are planning programmatic activities to manage stormwater to protect surface and ground water quality.

## **2.2 Exemptions**

The practices discussed in the following subsections are exempt from all eight of the Core Elements.

### ***Forest Practices***

Forest practices regulated under [Title 222 WAC](#) are exempt from the provisions of the Core Elements. Conversions of forest lands to other uses are not exempt.

### ***Commercial Agriculture***

Commercial agriculture practices involving working the land for production are generally exempt. However, the construction of impervious surfaces is not exempt.

### ***Oil and Gas Field Activities or Operations***

Construction of drilling sites, waste management pits, and access roads, as well as construction of transportation and treatment infrastructure such as pipelines natural gas treatment plants, natural gas pipeline compressor stations, and crude oil pumping stations are exempt. Operators are encouraged to implement and maintain Best Management Practices (BMPs) to minimize erosion and control sediment during and after construction activities to help ensure protection of surface water quality during storm events.

### ***Road and Parking Area Preservation/Maintenance***

The following road and parking area maintenance practices are exempt (see also partial exemptions in [2.3 Partial Exemptions](#)):

- Pothole and square cut patching
- Crack sealing
- Resurfacing with in-kind material (such as asphalt to asphalt) without expanding the road

prism or parking area

- Overlaying existing asphalt or concrete pavement with bituminous surface treatment (BST or “chip seal”), asphalt, or concrete without expanding the area of coverage
- Shoulder grading
- Reshaping/regrading drainage systems
- Vegetation maintenance

## 2.3 Partial Exemptions

Partial exemptions apply to certain practices associated with redevelopment projects only.

The practices discussed in the following subsections are generally exempt from all of the Core Elements except for [2.7.2 Core Element #1: Preparation of a Stormwater Site Plan](#) and [2.7.3 Core Element #2: Construction Stormwater Pollution Prevention](#).

### ***Underground Utility Projects***

Underground utility projects that replace the ground surface with in-kind material or materials with similar runoff characteristics are subject only to [2.7.2 Core Element #1: Preparation of a Stormwater Site Plan](#) and [2.7.3 Core Element #2: Construction Stormwater Pollution Prevention](#).

### ***Road and Parking Area Preservation/Maintenance***

A preservation or maintenance project is defined as preserving/protecting infrastructure by rehabilitating or replacing existing structures to maintain operational and structural integrity, and for the safe and efficient operation of the facility. Maintenance projects do not increase the traffic capacity of a roadway or parking area. The following practices are subject to only [2.7.2 Core Element #1: Preparation of a Stormwater Site Plan](#) and [2.7.3 Core Element #2: Construction Stormwater Pollution Prevention](#):

- Removing and replacing a concrete or asphalt roadway to base course or subgrade or lower without expanding the impervious surfaces.
- Repairing the roadway base or subgrade.
- Overlaying existing gravel with bituminous surface treatment (BST or “chip seal”), asphalt, or concrete without expanding the area of coverage, or overlaying BST with asphalt, without expanding the area of coverage. For this type of project, partial exemption applies under the following conditions only:
  - For roads, these practices are exempt from additional Core Elements only if the traffic surface will be subject to an average daily traffic (ADT) volume of < 7,500 on an urban road or an ADT volume of < 15,000 vehicles on a rural road, freeway, or limited access control highway. If these thresholds are exceeded, see [2.6 Redevelopment](#) to determine which Core Elements apply.
  - For parking areas, these practices are exempt from additional Core Elements only if the traffic surface will be subject to < 40 trip ends per 1,000 square feet of building area or

100 total trip ends. If either of these thresholds is exceeded, see [2.6 Redevelopment](#) to determine which Core Elements apply.

## **Transportation Safety Improvement Projects**

Transportation safety improvement projects are subject only to [2.7.2 Core Element #1: Preparation of a Stormwater Site Plan](#) and [2.7.3 Core Element #2: Construction Stormwater Pollution Prevention](#) except as specified under sub-item (a) under conditions for applying [2.7.6 Core Element #5: Runoff Treatment](#) in [2.6 Redevelopment](#). Applicable transportation safety improvement projects that do not enhance the traffic capacity of a roadway may include, for example, curb ramp improvements to enhance accessibility for compliance with the Americans with Disabilities Act. A transportation safety improvement project that does enhance the traffic carrying capacity of a roadway is not exempt from other Core Elements.

Certain transportation safety improvement projects such as sidewalks, bike lanes, bus pullouts and other transit improvements must be evaluated on a case-by-case basis to determine whether additional Core Elements apply. The case-by-case evaluation would be based on local jurisdiction requirements, the location of the project in relation to the roadway, and amount of impervious surface added or replaced.

## **2.4 Local Exceptions/Variations**

### **Guidelines for Local Exceptions/Variations**

Exceptions to the Core Elements may be granted prior to permit approval and construction. The local jurisdiction may grant an exception following an application for an exception with legal public notice per the local jurisdiction's guidance and requirements for exceptions and variations. The administrator's decision should include a written finding of fact that documents the following:

- There are special physical circumstances or conditions affecting the property such that would prohibit the strict application of these provisions.
- Every effort has been made to find alternative ways to meet the objectives of the Core Elements.
- The granting of the exception or variance will be neither detrimental to the public health and welfare nor injurious to other properties in the vicinity and/or downstream, and to the quality of waters of the state.
- The exception is the least possible exception that could be granted to comply with the intent of the Core Elements.

If the local jurisdiction chooses to allow jurisdiction-wide exceptions or variations to the requirements of the *Stormwater Management Manual for Eastern Washington* (manual), those exceptions must be approved by the Washington State Department of Ecology or other agency exercising its permitting authority. Project-specific design deviations based on site-specific conditions generally do not require approval of the permitting authority and are left to the discretion of the local jurisdiction.

## ***Supplemental Guidelines for Local Exceptions/Variances***

The exception and variance provisions are an important element of the plan review and enforcement programs. They are intended to maintain a necessary flexible working relationship between local officials and applicants. Local jurisdictions should consider these requests judiciously, keeping in mind both the need of the applicant to maximize cost-effectiveness and the need to protect off-site properties and resources from damage.

## **2.5 New Development**

Determining whether a project is new development or redevelopment is important in the selection of Core Elements. See [Definition of New Development](#) and [Definition of Redevelopment](#).

### ***Definition of New Development***

New development is defined as follows:

Land disturbing activities, including Class IV general forest practices that are conversions from timber land to other uses; structural development, including construction or installation of a building or other structure; creation of impervious surfaces; and subdivision, short subdivision and binding site plans. Projects meeting the definition of redevelopment shall not be considered new development.

### ***Guidelines for New Development***

[Figure 2.1: Flow Chart for Determining Applicable Core Elements for New Development Projects](#) provides a flow chart summarizing the Core Elements that apply to new development projects, while the text in this section provides a narrative description.

For projects that are implemented in incremental stages or phases as part of a common plan of development or sale, the new development thresholds apply to the total amount of impervious surfaces added at full build-out.

All new development projects must comply with the following Core Elements for the entire project site. See [2.7 Core Elements](#):

- [2.7.2 Core Element #1: Preparation of a Stormwater Site Plan](#)
- [2.7.3 Core Element #2: Construction Stormwater Pollution Prevention](#)
- [2.7.4 Core Element #3: Source Control of Pollution](#)
- [2.7.5 Core Element #4: Preservation of Natural Drainage Systems](#)
- [2.7.9 Core Element #8: Local Requirements](#)

When the thresholds for [2.7.6 Core Element #5: Runoff Treatment](#) are met (see [2.7.6 Core Element #5: Runoff Treatment](#)), the following Core Elements also apply to the new pollution-generating impervious surface (PGIS) area:

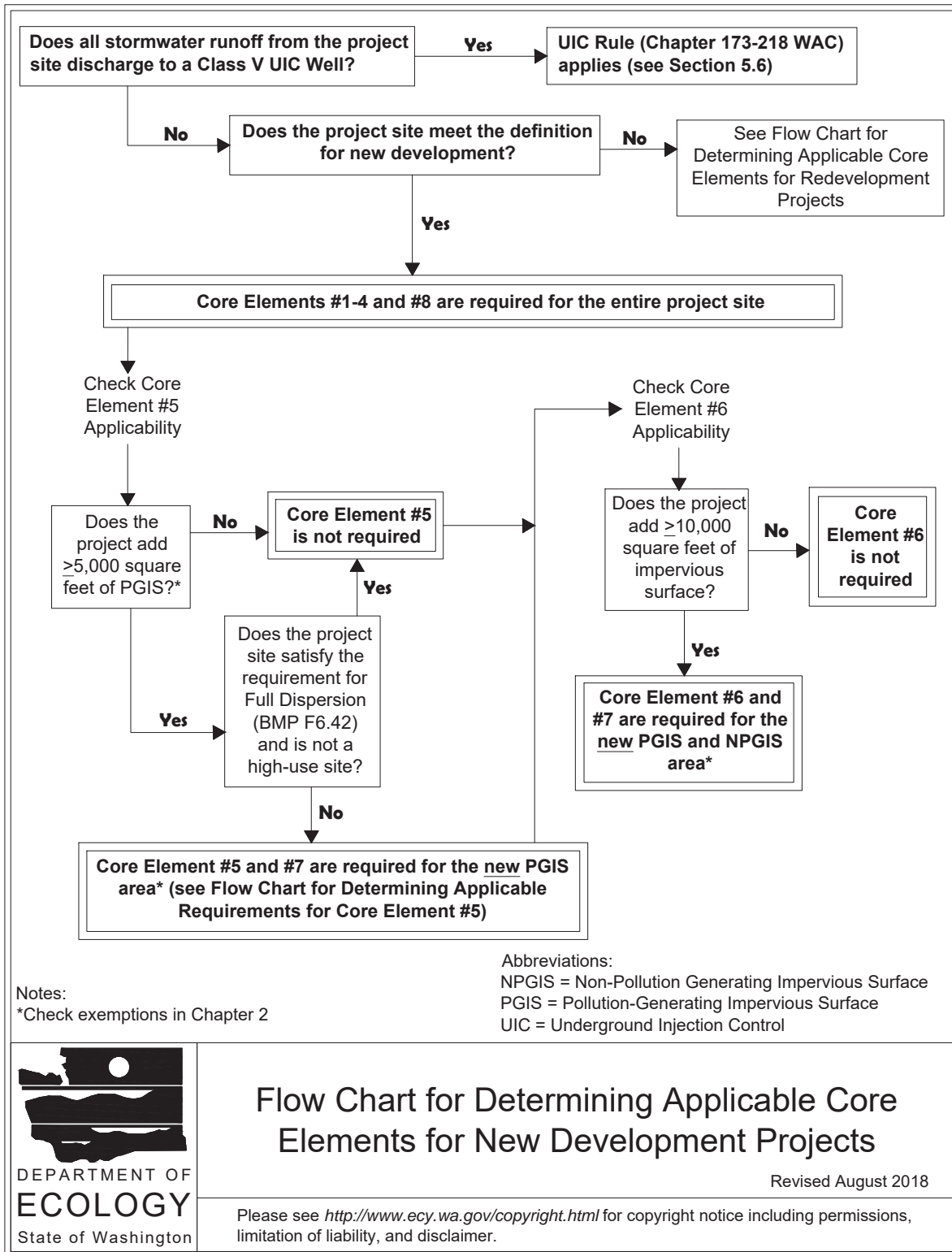
- [2.7.6 Core Element #5: Runoff Treatment](#)
- [2.7.8 Core Element #7: Operation and Maintenance](#)

When the thresholds for [2.7.7 Core Element #6: Flow Control](#) are met (see [2.7.7 Core Element #6: Flow Control](#)), the following Core Elements also apply to the new PGIS and non-pollution-generating impervious surface (NPGIS) area:

- [2.7.7 Core Element #6: Flow Control](#)
- [2.7.8 Core Element #7: Operation and Maintenance](#)



**Figure 2.1: Flow Chart for Determining Applicable Core Elements for New Development Projects**



## 2.6 Redevelopment

### *Definition of Redevelopment*

Redevelopment is defined as follows:

On a site that is already substantially developed, the replacement or improvement of impervious surfaces, including buildings and other structures, and replacement or improvement of impervious parking and road surfaces, that is not part of a routine maintenance activity. Any new impervious surfaces created by a redevelopment project are subject to the requirements for new development.

Impervious surface replacements defined as exempt activities in [2.2 Exemptions](#) and other projects identified as partially exempt in [2.3 Partial Exemptions](#) have reduced requirements.

### *Long-Term Objective of the Redevelopment Standard*

The long-term objective of the redevelopment standard is to reduce stormwater pollution from existing developed sites, especially when a water quality problem has been identified or the site is being improved to accommodate a use with a greater potential to contribute pollution to the receiving waters. More stringent redevelopment thresholds and requirements may be identified through a water cleanup plan such as a Total Maximum Daily Load (TMDL) study and allocation or another basin planning process.

To encourage redevelopment projects, replaced or improved surfaces are not required to meet the Core Elements unless the use or area thresholds identified in [2.4 Local Exceptions/Variations](#) are met or exceeded for the redevelopment project scope.

[Figure 2.2: Flow Chart for Determining Applicable Core Elements for Redevelopment Projects](#) provides a flow chart summarizing the Core Elements that apply to redevelopment projects. [Guidelines for New Impervious Surfaces](#) and [Guidelines for Replaced Impervious Surfaces](#) must be followed for a project to comply with the stormwater management provisions set forth in the *Stormwater Management Manual for Eastern Washington* (manual).

### *Guidelines for New Impervious Surfaces*

For projects that are implemented in incremental stages or phases, the redevelopment thresholds apply to the total amount of new impervious surfaces added at full build-out.

All new impervious surfaces added during nonexempt redevelopment project activities are subject to the following Core Elements (see [2.7 Core Elements](#)):

- [2.7.2 Core Element #1: Preparation of a Stormwater Site Plan](#)
- [2.7.3 Core Element #2: Construction Stormwater Pollution Prevention](#)
- [2.7.4 Core Element #3: Source Control of Pollution](#)
- [2.7.5 Core Element #4: Preservation of Natural Drainage Systems](#)
- [2.7.9 Core Element #8: Local Requirements](#)

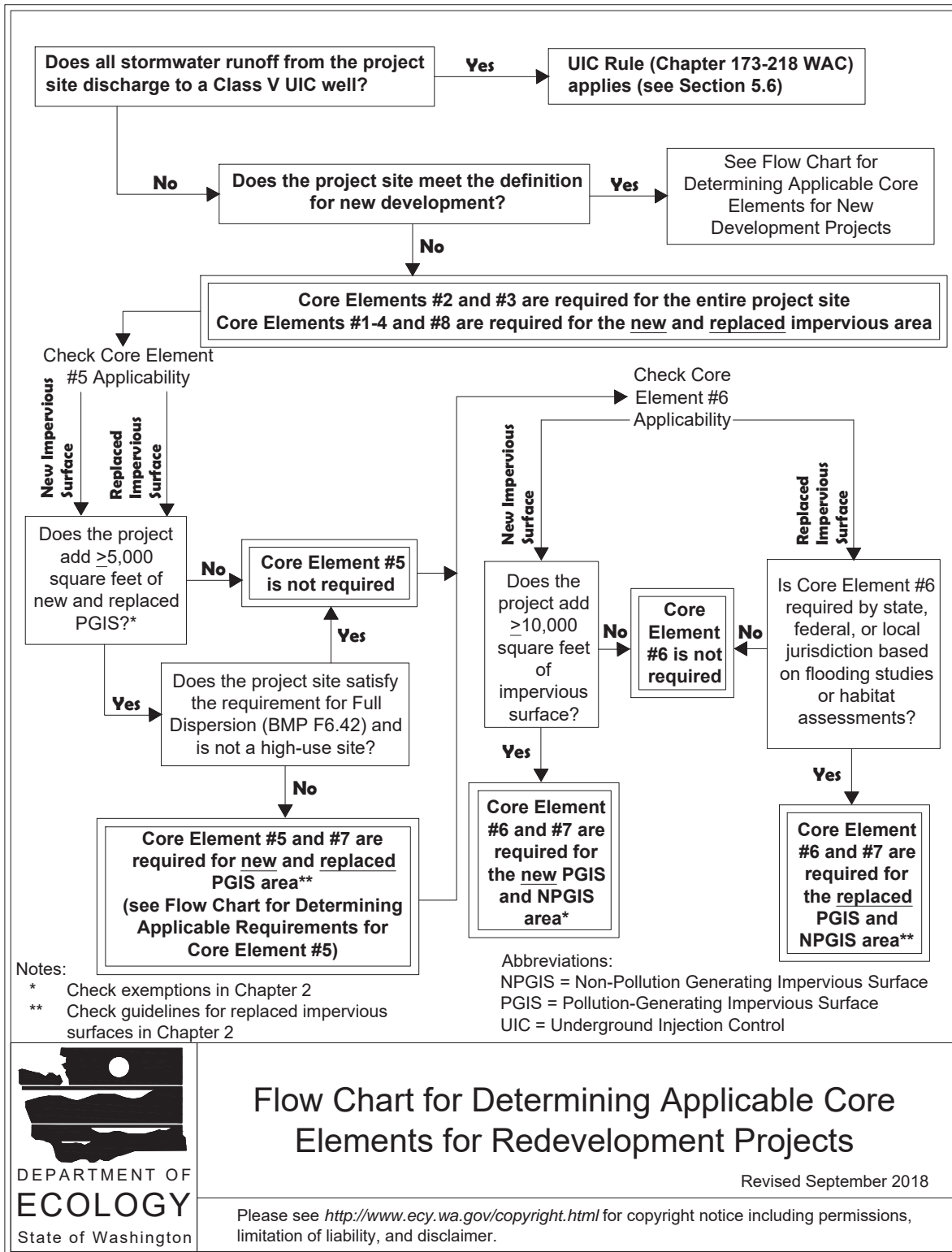
When the thresholds for [2.7.6 Core Element #5: Runoff Treatment](#) are met (see [Figure 2.2: Flow Chart for Determining Applicable Core Elements for Redevelopment Projects](#) and [2.7.6 Core Element #5: Runoff Treatment](#)), the following Core Elements also apply:

- [2.7.6 Core Element #5: Runoff Treatment](#)
- [2.7.8 Core Element #7: Operation and Maintenance](#)

When the thresholds for [2.7.7 Core Element #6: Flow Control](#) are met (see [Figure 2.2: Flow Chart for Determining Applicable Core Elements for Redevelopment Projects](#) and [2.7.7 Core Element #6: Flow Control](#)), the following Core Elements also apply:

- [2.7.7 Core Element #6: Flow Control](#)
- [2.7.8 Core Element #7: Operation and Maintenance](#)

**Figure 2.2: Flow Chart for Determining Applicable Core Elements for Redevelopment Projects**



## ***Guidelines for Replaced Impervious Surfaces***

When the following conditions are met, the identified Core Elements ([2.7 Core Elements](#)) apply to replaced impervious surfaces. For projects that are implemented in incremental stages or phases, the redevelopment thresholds apply to the total amount of impervious surfaces replaced at full build-out.

Where replacement of  $\geq 5,000$  square feet (sf) of existing pollution-generating impervious surface (PGIS) occurs, the following requirements are invoked:

- Core Elements #2 and #3 shall be applied to the entire project site that is affected by the project activities.
- Core Elements #1, #4, #7, and #8 shall apply to the portion of the project site where any impervious surfaces are replaced (includes both PGIS and non-pollution-generating impervious surface [NPGIS] areas).
- Core Element #5 (Runoff Treatment) shall be applied to the new PGIS and replaced PGIS area at the project site if any of the following conditions exist. The thresholds in the following list are for basic treatment. See [Metals Treatment Requirements](#), [Oil Control Requirements](#), and [Phosphorus Treatment Requirements](#) for additional treatment requirements that may also apply.
  - The project takes place at an industrial site as defined by the U.S. Environmental Protection Agency (U.S. EPA) ([40 CFR 122.26\(b\)\(14\)](#)) with outdoor handling, processing, storage, or transfer of solid raw materials or finished products. Additional treatment to remove metals is required for sites that are subject to benchmark monitoring requirements for metals.
  - The project takes place at a commercial site with outdoor storage or transfer of solid raw materials or treated wood products.
  - A need for additional stormwater control measures has been identified through a TMDL or other water cleanup plan or other planning process. (Local jurisdictions are cautioned that they may have difficulty meeting TMDL waste load allocations if they wait until corrective actions are required by a TMDL. See [Local Retrofit Programs](#).)
  - The project takes place at a high-use site and additional treatment must be provided to remove oil. A high-use site is any one of the following:
    - A road intersection with expected ADT of  $\geq 25,000$  vehicles on the main roadway and  $\geq 15,000$  vehicles on any intersecting roadway, excluding projects proposing primarily pedestrian or bicycle use improvements
    - A commercial or industrial site with an expected trip end count  $\geq 100$  vehicles per 1,000 square feet of gross building area (best professional judgment should be used in comparing this criterion with the following criterion)
    - A customer or visitor parking lot with an expected trip end count  $\geq 300$  vehicles (best professional judgment should be used in comparing this criterion with the preceding criterion); or

- Commercial on-street parking areas on streets with an expected total ADT of  $\geq 7,500$
  - Fueling stations and facilities
  - A commercial or industrial site subject to petroleum storage and transfer  $> 1,500$  gallons per year, not including locations where heating fuel is routinely delivered to end users (heating fuel handling and storage facilities are subject to this definition)
  - A commercial or industrial site subject to use, storage, or maintenance of a fleet of  $\geq 25$  diesel vehicles that are  $> 10$  tons gross weight (trucks, buses, trains, heavy equipment, etc.)
  - Maintenance and repair facilities for vehicles, aircraft, construction equipment, railroad equipment or industrial machinery and equipment
  - Outdoor areas where hydraulic equipment is stored
  - Log storage and sorting yards and other sites subject to frequent use of forklifts and/or other hydraulic equipment
  - Railroad yards
- The project takes place in an area subject to vehicular traffic under any of the conditions listed below. Note that preservation/maintenance projects and some improvement and safety enhancement projects that do not increase motorized vehicular capacities are exempt from the Core Elements as defined in [2.2 Exemptions](#) or partially exempt as defined in [2.3 Partial Exemptions](#). See the definition of average daily traffic (ADT) and trip ends in the glossary.
  - The project improves a vegetated shoulder to a curb and gutter roadway with an ADT volume of  $\geq 7,500$ . See [2.3 Partial Exemptions](#) for partial exemptions for other safety improvement projects.
  - The project replaces and/or improves the surface of a parking area where the projected number of trip ends  $>$  either 40 per 1,000 sf of building area or 100 total trip ends per day. Additional treatment to remove both oil and metals is required if the projected number of trip ends exceeds either 100 per 1,000 sf of building area or 300 total trip ends per day.
  - The project replaces and/or improves the surface of an urban road where the projected ADT volume is  $\geq 7,500$ .
  - The project replaces and/or improves the surface of a rural road, freeway, or highway with limited access control where the projected ADT volume is  $\geq 15,000$ .
  - The project affects the area within 500 feet of a controlled intersection on a limited access control highway with projected ADT volume of  $\geq 7,500$ . Only the area within 500 feet of the intersection must be treated.
- [2.7.7 Core Element #6: Flow Control](#) shall be applied to all the replaced impervious surfaces

at the project site (includes both PGIS and NPGIS areas) if required by the state, federal, or local jurisdiction based on flooding studies or habitat assessments.

### **Local Retrofit Programs**

If a local jurisdiction chooses to implement an optional retrofit program, then those requirements may replace the guidelines for replaced impervious surfaces. The program must meet the intent of the requirements in [Guidelines for Replaced Impervious Surfaces](#), be at least as stringent as the thresholds in [Guidelines for Replaced Impervious Surfaces](#) in terms of the number and types of projects regulated, and may need approval from the Washington State Department of Ecology (Ecology). Local jurisdictions can select from the following for identifying projects:

- Exceeding 50% of the assessed value of the existing improvements
- Exceeding 50% of the replacement value of the existing site
- Exceeding a certain dollar value of improvements
- Exceeding a certain ratio of the new impervious surfaces to the total of replaced plus new impervious surfaces
- Exceeding an established threshold of added or replaced surfaces (e.g., the project adds  $\geq 10,000$  sf of new impervious surfaces or replaces 20,000 sf of impervious surfaces)
- There is a change in the use of the site to a use with greater potential to contaminate stormwater

The local jurisdiction may allow the Core Elements to be met for an area with equivalent flow and pollution characteristics that drains to the same receiving water. For public road projects, the equivalent area does not have to be within the project limits, but must drain to the same water body segment and be located upstream from a confluence with another water body downstream from the project site.

### **Supplemental Guidelines for Redevelopment**

Local jurisdictions may institute a stop-loss provision (an upper limit on the extent to which requirement is applied) on the application of stormwater requirements that apply to replaced impervious surfaces. A stop-loss provision may not, however, be instituted for the application of stormwater requirements for new impervious surfaces.

For instance, there could be a maximum percentage of the estimated total project costs that are dedicated to meeting stormwater requirements for replaced impervious surfaces. A project would not have to incur additional stormwater costs above that maximum though the standard redevelopment requirements would not be fully achieved.

Allowances may also be made for sites that would, by imposing the treatment requirement, become nonconforming to other requirements that apply to the site. Every effort should still be made to find creative ways to meet the intent of the Core Elements. The allowance for a stop-loss provision pertains to the extent that treatment, flow control and wetlands protection requirements are imposed on replaced impervious surfaces. It does not apply to meeting stormwater requirements for new impervious surfaces.

For redevelopment projects that discharge into the municipal drainage system, local jurisdictions may also establish criteria for allowing payment of a fee-in-lieu of constructing runoff treatment or flow control BMPs. At a minimum, the fee should be the equivalent of an engineering estimate of the cost of meeting all applicable stormwater requirements for the project. The local jurisdiction should use such funds for the implementation of stormwater control projects that would have similar benefits to the same receiving water as if the project had constructed its required improvements. The stormwater control project could be a regional BMP that includes service to the redevelopment site, or a BMP serving other public or private lands tributary to the same receiving water. Expenditure of such funds is subject to other state statutory requirements.

Ecology cautions local jurisdictions about the potential long-term consequences of allowing a fee-in-lieu of stormwater BMPs. Project proponents that are allowed to pay a fee may continue without stormwater controls. If it is determined, through future basin planning for instance, that controls on such sites are necessary to achieve water quality goals or legal requirements, the public may bear the costs for providing those controls.

Local jurisdictions may require runoff treatment BMPs for redevelopment projects that discharge to a receiving water that has a documented water quality problem. This provision should focus on water quality problems for metals, oil and grease, bacteria, sediment, suspended solids, phosphorus, or any other water quality problem to which stormwater is considered a contributor.

Sites with 100% existing building coverage that are currently connected to a municipally owned storm sewer or combined sewer must be evaluated on a case-by-case basis to continue to be connected without treatment. Additional local requirements such as flow restrictors may also be required.

## ***Recommendations for Local Jurisdictions***

As part of the routine project approval and permitting process, local jurisdictions should review redevelopment project plans for intent and completeness in meeting the redevelopment guidelines. Where space is limited, staff may assist project proponents in modifying Best Management Practices (BMPs) and/or finding creative ways to meet the intent of the Core Elements. Optionally, local jurisdictions may conduct planning for regional runoff treatment BMPs in areas where meeting the on-site treatment objectives for individual redevelopment projects would be challenging.

## **2.7 Core Elements**

### **2.7.1 Introduction to the Core Elements**

This section describes the eight Core Elements for stormwater management at development and redevelopment sites in eastern Washington. [Chapter 5 - Runoff Treatment BMP Design](#) through [Chapter 8 - Source Control](#) of the *Stormwater Management Manual for Eastern Washington* (manual) contain Best Management Practices (BMPs) to choose from in implementing these Core Elements for each project.

Project proponents shall apply whatever technology is necessary to comply with state water quality standards, [Chapter 173-201A WAC](#), or state ground water standards, [Chapter 173-201A WAC](#). Additional treatment requirements to meet those standards may be required by federal, state, or



local jurisdictions. The requirements of these Core Elements do not excuse the project proponent from the obligation to meet applicable water quality standards.

Each Core Element includes an objective, guidelines, applicability to UIC wells and/or wetlands, supplemental guidelines, and recommendations for local jurisdictions.

## **2.7.2 Core Element #1: Preparation of a Stormwater Site Plan**

### ***Objective***

Stormwater management is most successful when integrated into project planning and design. Projects are expected to demonstrate compliance with the applicable Core Elements through preparation of a Stormwater Site Plan (SSP).

### ***Guidelines***

All projects, including those proposed by local jurisdiction departments and agencies, that are subject to Core Elements #2 through #8 are expected to complete an SSP. When required, SSPs shall be prepared in accordance with [Chapter 3 - Preparation of Stormwater Site Plans](#).

The local jurisdiction shall determine the process for ensuring proper project review, inspection, and compliance by its own departments and agencies.

### ***Applicability to UIC Wells***

See [5.6 Subsurface Infiltration \(Underground Injection Control Wells\)](#) for requirements for discharges to UIC wells.

### ***Supplemental Guidelines***

A simplified SSP may be developed by the local jurisdiction and made available for use by proponents of small projects.

### ***Recommendations for Local Jurisdictions***

As part of the routine project approval and permitting process, local jurisdictions should review SSPs for completeness and adequacy in fulfilling the objectives of the Core Elements. Plan review staff should be trained in the application of this manual or the approved local equivalent.

## **2.7.3 Core Element #2: Construction Stormwater Pollution Prevention**

### ***Objective***

Runoff from project sites during the construction phase can contribute quantities of sediment and other contaminants sufficient to result in water quality violations. Sediment-laden runoff can enter drywells, reducing their infiltration capacity and lifetime of operation or increasing maintenance costs.

Controlling erosion and preventing sediment and other pollutants from leaving the project site during the construction phase is achievable through implementation of selected Best Management Practices (BMPs) that are appropriate both to the site and to the season during which construction

activities take place. The Construction Stormwater Pollution Prevention Plan (SWPPP) identifies project-specific guidance for preventing pollution resulting from erosion and sediment runoff during the construction phase. A well-written SWPPP provides guidance that is neither over- nor underprotective of the project site. The Construction SWPPP should include seasonally appropriate guidance and anticipate adjustments that may be necessary in the event of delays in the construction schedule.

## **Guidelines**

When Core Element #2 is required, [2.7.2 Core Element #1: Preparation of a Stormwater Site Plan](#) is also required. Project proponents may be required to obtain a Construction Stormwater General Permit (CSWGP) from the Washington State Department of Ecology (Ecology) prior to beginning construction. See Ecology's website (<https://ecology.wa.gov/>) for details on when a CSWGP is required and how to obtain one when it is needed.

**Note:** Local jurisdiction requirements ([2.7.9 Core Element #8: Local Requirements](#)) may also apply for projects that do not trigger a CSWGP.

## **Construction SWPPP Elements**

Project proponents are responsible for preventing erosion and discharge of sediment from the project site into surface waters of the State and must consider each of the 13 elements of pollution prevention to determine which controls are appropriate for the project site. The SWPPP elements listed in this section are from the latest version of Ecology's CSWGP. [Chapter 7 - Construction Stormwater Pollution Prevention](#) identifies and describes appropriate BMPs for each of these elements.

The 13 Construction SWPPP elements are listed below. See [Chapter 7 - Construction Stormwater Pollution Prevention](#) for a description of each of these elements and suggested BMPs for each element.

1. Mark Clearing Limits
2. Establish Construction Access
3. Control Flow Rates
4. Install Sediment Controls
5. Stabilize Soils
6. Protect Slopes
7. Protect Drain Inlets
8. Stabilize Channels and Outlets
9. Control Pollutants
10. Control Dewatering
11. Maintain BMPs

## 12. Manage the Project

## 13. Protect Low Impact Development BMPs (Infiltration BMPs)

If erosion and sediment control requirements are not being met (i.e., sediment-laden water is leaving the site), then the local jurisdiction shall require that the contractor maintain the existing BMPs or implement other BMPs as appropriate.

### **Maintaining an Updated SWPPP**

Contractors must maintain the Construction SWPPP on the construction site for reference and use by project personnel. The SWPPP, including the site map, must be amended whenever there is a change in design, construction, operation, or maintenance at the construction site that has or could have a significant effect on the discharge of pollutants to surface or ground water that has not been previously addressed in the SWPPP. The SWPPP must be amended if during inspections or investigations by site staff, Ecology, or by the jurisdiction, it is determined that the SWPPP is ineffective in eliminating or significantly minimizing pollutants in stormwater discharges from the construction site. Based on the results of an inspection, the SWPPP must be modified as necessary to include additional or modified BMPs designed to correct problems identified. Revisions to the SWPPP must be completed within 7 calendar days following the inspection. Implementation of these additional or modified BMPs must be accomplished before the next storm event whenever practicable. Where implementation before the next storm event is impracticable, the situation must be documented in the SWPPP and alternative BMPs must be implemented as soon as possible.

### ***Applicability to UIC Wells***

UIC wells can be a small portion of a project scope. Implementation of Core Element #2 applies to the full project site, not just the area needed to install the UIC well. For the portions of the project site that discharge to UIC wells, see [5.6 Subsurface Infiltration \(Underground Injection Control Wells\)](#). For portions of the project site that do not discharge to UIC wells or for which UIC wells do not result in the infiltration of all of the stormwater runoff, follow the requirements and guidelines in this section.

### ***Supplemental Guidelines***

The local jurisdiction may allow development of generic Construction SWPPPs that apply to commonly conducted projects such as public road activities.

### ***Recommendations for Local Jurisdictions***

Local jurisdictions should review SWPPPs for completeness and adequacy in meeting the objectives of Core Element #2. Train staff inspecting projects during construction in assessing the application of erosion and sediment control BMPs and how to address deficiencies.

## **2.7.4 Core Element #3: Source Control of Pollution**

### ***Objective***

The intent of source control Best Management Practices (BMPs) is to prevent pollutants from coming into contact with stormwater. Source control BMPs are a cost-effective means of reducing pollutant loading and concentrations in stormwater and should be a first consideration in all projects.

## **Guidelines**

Following construction, projects shall apply all known, available and reasonable source control BMPs. Source control BMPs shall be selected, designed, and maintained according to this manual. Source control BMPs identified for Core Element #3 are separate from those implemented for [2.7.3 Core Element #2: Construction Stormwater Pollution Prevention](#). Source control BMPs installed to satisfy Core Element #3 require long-term maintenance to ensure successful operation.

Considering opportunities for structural separation of surfaces exposed to pollutants and other source control alternatives during the project design stage may result in eliminating or reducing the size of facilities required under [2.7.6 Core Element #5: Runoff Treatment](#).

## **Applicability to UIC Wells**

See [5.6 Subsurface Infiltration \(Underground Injection Control Wells\)](#) for requirements for discharges to UIC wells.

## **Applicability to Wetlands**

Core Element #3 is required for all projects with discharges to wetlands. Operational and source control BMPs may not be sufficient to protect wetlands from salts and other chemical anti-icing and deicing chemicals that can accumulate and impact the biological functions of a wetland. Separation and routing of runoff to an alternative discharge location may be necessary to protect the wetland from runoff from road and other surfaces subject to such chemical use.

## **Supplemental Guidelines**

A basin plan adopted and implemented by a local jurisdiction or an approved Total Maximum Daily Load (TMDL, also known as a water cleanup plan) may be used to develop more stringent source control requirements that are tailored to a specific basin.

**For more information:** Source Control BMPs include Operational BMPs and Structural Source Control BMPs. See [Chapter 8 - Source Control](#) for design details of these BMPs. For construction sites, see [Chapter 7 - Construction Stormwater Pollution Prevention](#).

## **Recommendations for Local Jurisdictions**

During plan review, local jurisdictions should evaluate whether selected source control BMPs will meet the objectives of Core Element #3. Train staff conducting inspections of commercial and industrial facilities in assessing the proper selection and implementation of source control BMPs and how to address deficiencies.

## **2.7.5 Core Element #4: Preservation of Natural Drainage Systems**

### **Objective**

Maintain natural drainage patterns and locate discharges from the project site at the natural location to the maximum extent practicable. Preservation of natural drainage systems provides multiple benefits for stormwater management. Creating new drainage patterns results in more site disturbance and more potential for erosion and sedimentation during and after construction.

Creating new discharge points can create significant stream channel erosion problems as the receiving water body typically must adjust to the new flows. Diversions can cause greater impacts than would otherwise occur by discharging runoff at the natural location. Wetlands can be severely degraded by discharges from urban development due to pollutants in the runoff and to disruption of the natural hydrology (especially changes in water levels and the duration of inundations) of the wetland system.

## **Guidelines**

To the maximum extent practicable, discharge stormwater in the same manner, at the same location, and at the same flow rate and volume as under the conditions that existed prior to development. Because some change in natural flow patterns is unavoidable after development, the preferred options for discharge of excess stormwater, listed in order of preference to maintain natural drainage systems, are the following:

1. Maintain dispersed sheet flow to match natural conditions.
2. Infiltrate on-site.
3. Infiltrate off-site.
4. Discharge to existing ditch networks, canals, or other dispersal methods that allow for potential ground water recharge.
5. Discharge to wetlands, if allowed.
6. Discharge to existing private or municipally owned stormwater systems, if allowed.
7. Evaporate on-site or off-site.
8. Create a new outfall for discharge to receiving waters.

Core Element #4 includes stormwater infiltration if that is the natural discharge method for the site. The designer shall investigate whether shallow ground water, a sensitive aquifer, or other concerns will affect design choices for the project.

The manner by which runoff is discharged from the project site must not cause a significant adverse impact on downstream receiving waters and downgradient properties. This should be addressed as part of the off-site analysis described in [Appendix 3-A: Off-Site Analysis](#).

All outfalls must address energy dissipation as necessary. A project proponent who believes that energy dissipation should not be required for a new outfall must provide justification in the project's SSP or drainage study report.

**Note:** Runoff treatment or flow control may be required prior to any discharge according to the requirements of [2.7.6 Core Element #5: Runoff Treatment](#) or [2.7.7 Core Element #6: Flow Control](#).

## **Applicability to UIC Wells**

See [5.6 Subsurface Infiltration \(Underground Injection Control Wells\)](#) for requirements for discharges to UIC wells.

## ***Applicability to Wetlands***

Discharge of stormwater to existing jurisdictional wetlands, either directly or via a conveyance system, should be avoided unless the wetland receives surface runoff from the existing site. If possible, only stormwater from landscape and roof areas should be discharged to wetlands. The discharge must comply with all applicable Core Elements to ensure that wetlands receive the same level of protection as any other waters of the State. See [2.7.6 Core Element #5: Runoff Treatment](#) and [2.7.7 Core Element #6: Flow Control](#) for guidelines for evaluating whether an existing wetland may be used as a runoff treatment or flow control BMP.

## ***Supplemental Guidelines***

For projects with no identified discharge point, local jurisdictions may wish to adopt guidance for management of the collected water per the requirements of [2.7.7 Core Element #6: Flow Control](#). The guidance is intended to protect downstream properties from flooding as a result of postconstruction concentrated runoff.

Where no conveyance system exists at the adjacent downgradient property line and the discharge was previously unconcentrated flow or significantly less concentrated flow, measures must be taken to prevent downgradient impacts. Drainage easements from downstream property owners may be needed and should be obtained prior to approval of engineering plans.

Designs for outfall systems to protect against adverse impacts from concentrated runoff are included in [Chapter 5 - Runoff Treatment BMP Design](#).

## ***Recommendations for Local Jurisdictions***

During plan review, local jurisdictions should consider whether the construction and stormwater management approaches meet the objectives of this Core Element. Local jurisdictions may also wish to provide project proponents with resources about appropriate low impact development (LID) techniques that can assist in meeting the objectives of this Core Element as part of [2.7.9 Core Element #8: Local Requirements](#).

**For more information:** See [Appendix 3-D: Additional Guidance on Low Impact Development Site Planning Principles and Design Strategies](#) for LID site planning information.

## **2.7.6 Core Element #5: Runoff Treatment**

### ***Objective***

The purpose of runoff treatment is to reduce pollutant loads and concentrations in stormwater runoff using physical, biological, and chemical removal mechanisms to protect water quality so that beneficial uses of receiving waters are maintained and where applicable, restored. The most effective basic treatment BMPs remove about 80% of the total suspended solids (TSS) contained in the runoff treated and a much smaller percentage of the dissolved pollutants. An analysis of the proposed land use at the project site and identification of the receiving water is used to determine the pollutants of concern and the appropriate treatment method(s) to apply at the site. In some cases, additional treatment to remove oil, metals, and/or phosphorus from stormwater runoff may be required to protect water quality.

The goal of Core Element #5 is to treat at least 90% of the average annual runoff volume generated by the pollution-generating surfaces at a project site. The total quantity of pollutants removed from the stormwater will vary greatly from site to site based on precipitation patterns, land use, effectiveness of source control, and operation and maintenance (O&M) of the runoff treatment BMPs. Proper O&M of runoff treatment BMPs is essential to protecting receiving waters over the long term.

## ***Exemptions***

Any of the exemptions listed under basic treatment, metals treatment, oil control, or phosphorus treatment may be negated by requirements set forth in TMDL or water cleanup plan.

### **Basic Treatment Exemptions**

Non-pollution-generating impervious surface (NPGIS) areas are exempt from basic treatment requirements unless the runoff from these areas is not separated from the runoff generated from pollution-generating impervious surface (PGIS) areas. All runoff treatment BMPs must be sized for the entire flow that is directed to them.

Project sites that manage all stormwater runoff via Full Dispersion ([BMP F6.42: Full Dispersion](#)) or UIC wells (see [1.4.6 Underground Injection Control Program](#) and [5.6 Subsurface Infiltration \(Underground Injection Control Wells\)](#)) and do not meet the requirements for oil control are exempt from all Core Elements. However, treatment is required for UIC wells as directed in [5.6 Subsurface Infiltration \(Underground Injection Control Wells\)](#).

Discharges to surface water from project sites with a total PGIS area < 5,000 square feet (sf) (e.g., new PGIS plus replaced PGIS) are exempt from basic treatment requirements unless those areas are subject to the storage or handling of hazardous substances, materials or wastes as defined in [49 CFR 171.8](#), [RCW 70.105.010](#), and/or [RCW 70.136.020](#).

### **Metals Treatment Exemptions**

Unless a specific water quality problem has been identified, the following discharges are exempt from metals treatment requirements:

- Discharges to non-fish-bearing streams
- Direct discharges to the main channels of the following rivers, lakes, and reservoirs:
  - Banks Lake
  - Lake Chelan
  - Columbia River
  - Grande Ronde River
  - Kettle River
  - Klickitat River
  - Methow River

- Moses Lake
  - Potholes Reservoir
  - Naches River
  - Okanogan River
  - Pend Oreille River
  - Similkameen River
  - Snake River
  - Wenatchee River
  - Yakima River
- Subsurface discharges, unless identified as hydraulically connected to nonexempt waters
  - Restricted residential and employee-only parking areas, unless subject to through traffic
  - Road and parking area preservation/maintenance projects and transportation safety improvement projects that do not increase motorized vehicular capacities (see [2.2 Exemptions](#) and [2.3 Partial Exemptions](#))

Certain exemptions may also exist for Category 4 wetlands (see “[Applicability to Wetlands](#)”).

### **Oil Control Exemptions**

No high-use sites and roads or parking areas with high average daily traffic (ADT) are exempt from oil control requirements. Preservation/maintenance projects and some transportation safety improvement projects that do not increase motorized vehicular capacities as described in [2.2 Exemptions](#) and [2.3 Partial Exemptions](#)) are exempt from oil control requirements.

### **Guidelines**

When site conditions are appropriate, infiltration can potentially be the most effective BMP for runoff treatment. Given sufficient treatment capacity in the vadose zone below an UIC well, such as a drywell, and the ground water table, limited pretreatment may be required for many of the pollutants of concern in stormwater. The criteria for determining the level of treatment required for a given proposed land use and site location are explained in [5.6 Subsurface Infiltration \(Underground Injection Control Wells\)](#).

Runoff treatment BMPs shall be selected, designed, sized, constructed, operated and maintained in accordance with the guidance in [Chapter 4 - Hydrologic Analysis and Design](#) and [Chapter 5 - Runoff Treatment BMP Design](#). [Figure 2.3: Flow Chart for Determining Applicable Requirements for Core Element #5 for New Development and Redevelopment Projects](#) guides project proponents towards the appropriate treatment type(s) based on new development and redevelopment thresholds and project site use. [Figure 5.1: Runoff Treatment BMP Selection Flow Chart](#) then directs project proponents towards selecting appropriate treatment BMPs based on the type of treatment required (e.g., basic, metals, oil control, phosphorus).



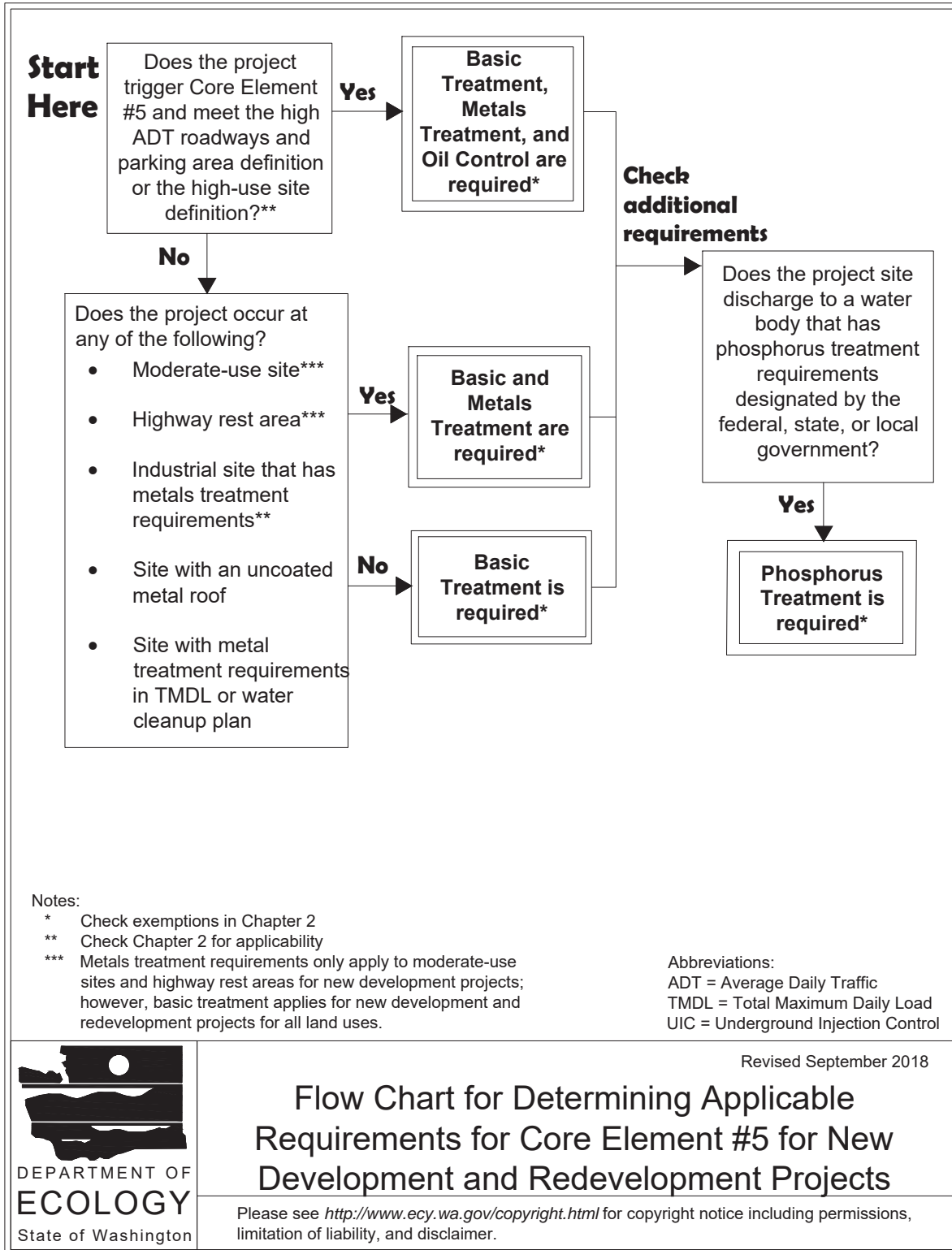
All runoff treatment BMPs must be sized for the applicable design storm(s) described in this section or according to alternative guidance as required by the local jurisdiction. In order to maintain the integrity and function of the treatment systems, runoff treatment BMPs must be sized for the entire flow that is directed to them.

In some situations, full or partial dispersion may provide adequate treatment in addition to disposing of the excess runoff from a site. See the [6.5 Dispersion BMPs](#) to determine whether one of these BMPs is a viable option for your project.

If it is possible for the project to meet treatment requirements by dispersal and infiltration (see [BMP F6.42: Full Dispersion](#)), the runoff should not be collected and concentrated; otherwise flow control ([2.7.7 Core Element #6: Flow Control](#)) may be required.

**Note:** When Core Element #5 is required, [2.7.8 Core Element #7: Operation and Maintenance](#) is also required.

**Figure 2.3: Flow Chart for Determining Applicable Requirements for Core Element #5 for New Development and Redevelopment Projects**



## **Basic Treatment Requirements**

Runoff treatment is required for all projects creating  $\geq 5,000$  sf of new pollution-generating impervious surfaces (PGIS) and replaced PGIS unless the discharge is to (1) a UIC well or (2) satisfies the requirements for full dispersion (see [BMP F6.42: Full Dispersion](#)) and is not a high-use site (see [Guidelines for Replaced Impervious Surfaces](#)). Treatment is required for discharges to all surface waters, including perennial and seasonal streams, lakes and wetlands where the PGIS threshold is met. Certain exemptions may exist for Category 4 wetlands (see [Applicability to Wetlands](#)). Runoff treatment is also required for discharges of stormwater to ground water via UIC wells where the vadose zone does not provide adequate treatment capacity (see [5.6 Subsurface Infiltration \(Underground Injection Control Wells\)](#)). Project designers should also consider the possible impact of additional TSS loading from pervious areas at the project site on the long-term function of the runoff treatment BMPs.

## **Metals Treatment Requirements**

Metals treatment is required for new development projects on moderate- and high-use sites (see definitions in the glossary) and sites that meet any of the following definitions and discharge to a nonexempt surface water:

- Industrial sites as defined by the U.S. Environmental Protection Agency (U.S. EPA) ([40 CFR 122.26\(b\)\(14\)](#)) with benchmark monitoring requirements for metals, or industrial sites subject to handling, storage, production, or disposal of metallic products or other materials, particularly those containing arsenic, cadmium, chromium, copper, lead, mercury, nickel or zinc
- An urban road with expected ADT  $> 7,500$ , or a rural road or freeway with expected ADT  $> 15,000$
- A commercial or industrial site with either an expected trip end count  $\geq 40$  vehicles per 1,000 sf of gross building area, or a customer or visitor parking lot with  $\geq 100$  trip ends, or on-street parking areas of municipal streets in commercial and industrial areas, or highway rest areas
- Runoff from metal roofs not coated with an inert, nonleachable material

The following portions of project sites are not subject to metals treatment requirements:

- Areas of arterials and highways, multifamily, industrial and commercial project sites that do not discharge to fish-bearing streams or lakes
- Areas identified in a storm drainage comprehensive plan or basin plan as subject to basic treatment requirements.

For project sites with a mix of land use types, the metals treatment requirement shall apply when the runoff from the areas subject to the metals treatment requirement constitutes  $\geq 50\%$  of the total runoff to a discharge location.

## **Oil Control Requirements**

Oil control is required for all high-use sites (see definition in [Guidelines for Replaced Impervious Surfaces](#)) and high-ADT areas (see definitions in the [Glossary](#)). Some sites will require a spill control type of oil control BMP (see [Chapter 8 - Source Control](#)) for source control separate from or in addition to this treatment requirement. High-ADT areas generate sufficient quantities of oil to threaten water quality, but the quantities of oil generated may be insufficient for many oil control BMPs to be effective. Therefore, these sites may use different BMPs than are recommended for high-use sites (see [Chapter 5 - Runoff Treatment BMP Design](#)). Projects proposing a high-use site must provide oil controls in addition to any other runoff treatment required per Core Element #5.

Approved oil and water separators (see [5.10 Oil and Water Separator BMPs](#)) are required for the following high-use sites:

- High-density intersections with expected ADT of  $\geq 25,000$  vehicles on main roadway and  $\geq 15,000$  vehicles on any intersecting roadway
- Nonemployee parking areas of commercial or industrial sites with trip end counts of either  $> 100$  vehicles per 1,000 sf gross building area or  $> 300$  vehicles total
- Areas of commercial and industrial sites subject to use, storage, or maintenance of a fleet of  $\geq 25$  diesel vehicles that are  $> 10$  tons gross weight
- Fueling stations and facilities
- Sites subjected to petroleum transfer volume  $> 1,500$  gallons per year, excluding routinely delivered heating oil

All other high-use sites (as defined in [Guidelines for Replaced Impervious Surfaces](#)) and high-ADT areas (as defined in the [Glossary](#)) subject to the oil control requirement are required to use sorptive technologies, due to their better ability to control smaller quantities of oil. Basic treatment methods with sorptive properties, such as biofiltration or bioinfiltration swales, filters, or other adsorptive technology may be used.

High-use roadway intersections shall treat lanes where vehicles accumulate during the signal cycle, including left- and right-turn lanes and through lanes, from the beginning of the left-turn pocket. If no left-turn pocket exists, the treatable area shall begin at a distance equal to three car lengths from the stop line. If runoff from the intersection drains to more than two collection areas that do not combine within the intersection, treatment may be limited to any two of the collection areas where the cars stop.

High-use sites and high-ADT roadways and parking areas must treat runoff from the high-use portion of the site using oil control options in [Chapter 5 - Runoff Treatment BMP Design](#) prior to discharge or infiltration. For high-use sites located within a larger project area, only the impervious area associated with the high-use site is subject to oil control treatment, but the flow from that area must be separated. Otherwise the treatment controls must be sized for the entire area.

If common parking for multiple businesses is provided, oil control shall be applied to the number of parking stalls required for the high-use business only. However, if the treatment collection area also receives runoff from other areas, the oil control BMP must be sized to treat all water passing through it.

## **Phosphorus Treatment Requirements**

Phosphorus treatment is required only where federal, state, or local jurisdiction has determined that a water body is sensitive to phosphorus and that a reduction in phosphorus from new development and redevelopment is necessary to achieve the water quality standard to protect its beneficial uses. Where it is deemed necessary, a strategy will be adopted to achieve the reduction in phosphorus. The strategy will be based on knowledge of the sources of phosphorus and the effectiveness of the proposed methods of removing phosphorus. Contact the local jurisdiction to determine if phosphorus treatment is required for your project.

### **Sizing of Runoff Treatment BMPs**

Each runoff treatment BMP is sized based on a water quality design volume or a water quality design flow rate. Agencies and local jurisdictions should adopt criteria to provide for consistent sizing of runoff treatment BMPs. The computational methods for predicting runoff volumes and flow rates for the proposed development condition are included in [Chapter 4 - Hydrologic Analysis and Design](#). Specific design criteria for runoff treatment BMPs also may be identified in [Chapter 5 - Runoff Treatment BMP Design](#) in order to achieve the performance goal of a particular BMP. Public road projects may be designed using BMPs in the latest approved edition of the Washington State Department of Transportation (WSDOT) *Highway Runoff Manual*.

#### **Water Quality Design Volume**

Volume-based treatment facilities are sized the same whether located upstream or downstream from detention BMPs. Each agency or local jurisdiction should specify which of the following methods will be used to determine treatment volumes in its jurisdiction. If the jurisdiction has not identified a preferred method, the default method shall be Method 1 in Climate Regions 1 and 4, and Method 2 in Climate Regions 2 and 3 (see [Figure 4.1: Average Annual Precipitation and Climate Regions](#)).

- **Method 1:** The volume of runoff predicted for the proposed development condition from the regional storm (72-hour) with a 6-month return frequency. An alternative to this method is the modified Type IA storm with a 6-month return frequency described in [Chapter 4 - Hydrologic Analysis and Design](#). Designers may use this alternative method on small projects where the designer's software does not accept storms longer than 24 hours.
- **Method 2:** The volume of runoff predicted for the proposed development condition from the SCS Type IA 24-hour storm with a 6-month return frequency.
- **Method 3:** In Climate Regions 2 and 3, volume-based treatment BMPs may be sized for 0.5-inch predicted runoff produced for the proposed development condition from all impervious surface areas that contribute flow to the runoff treatment BMP. (This method is modified for design of [BMP T5.30: Bioinfiltration Swales](#)) See [Figure 4.1: Average Annual Precipitation and Climate Regions](#) for a map of the four climate regions in eastern Washington.
- **Method 4:** The volume of runoff predicted for the proposed development condition from the SCS Type II 24-hour storm with a 6-month return frequency.
- **Method 5:** Another sizing approach and criteria based on peer-reviewed methods and supported by local data that meet the objective of treating at least 90% of the average annual runoff volume from the site.

- **Snowmelt considerations:** Snowmelt should be considered in determining the water quality design volume. This is especially important in Climate Regions 1 and 4 and also applies to other areas of eastern Washington. Check for local requirements (see [2.7.9 Core Element #8: Local Requirements](#)). A snowmelt factor based on the water content of the average annual daily depth of snow (or based on some other appropriate measurement) should be added to the depth of precipitation for calculating runoff treatment volume, or another method described in [4.3.9 Rain-on-Snow and Snowmelt Design](#) may be used.

### Water Quality Design Flow Rate

Flow-rate-based treatment BMPs are sized differently depending on whether they are located upstream or downstream from detention BMPs, if detention is required. Each agency or local jurisdiction should specify which of the following methods used in their jurisdiction to size facilities preceding detention ponds. If the jurisdiction has not identified a preferred method, the default method shall be Method 1 in all climate regions. For large facilities receiving inflow from multiple sources, the flow rate generated by the regional or SCS Type IA storm should also be checked.

For runoff treatment BMPs preceding detention BMPs or when detention BMPs are not required, use the following methods:

- **Method 1:** The runoff flow rate predicted for the proposed development condition from the short-duration (3-hour) storm with a 6-month return frequency. (Simulation time steps are specified in the BMP designs.)
- **Method 2:** The runoff flow rate predicted for the proposed development condition from the SCS Type II 24-hour storm with a 6-month return frequency. (Simulation time steps are specified in the BMP designs.)
- **Method 3:** The runoff flow rate for the proposed development condition calculated by the Rational Method using the 2-year mean recurrence interval (see [4.8.1 Introduction](#)). This method may only be used to design facilities based on instantaneous peak flow rates.

For runoff treatment BMPs sited downstream of detention BMPs, use the full 2-year release rate of the detention BMP.

### Bypass Requirements

A bypass must be provided for all runoff treatment BMPs unless the BMP is able to convey the 25-year short-duration (3-hour) storm without damaging the BMP or dislodging pollutants from within it. Extreme runoff events may produce high flow velocities through BMPs that can damage and or dislodge pollutants from within the BMP. The designer must check the maximum allowable velocity (typically < 2 feet per second [ft/sec]) or shear stress specified for the BMP and implement a flow bypass as necessary to prevent an exceedance of these velocities. Bypass is not recommended for wetponds, constructed wetlands, and similar volume-based runoff treatment BMPs. Inlet structures for these BMPs should be designed to dampen velocities. In these facilities, larger storms will be retained for a shorter detention time than the shorter storms for which the ponds are designed. See [5.3 General Requirements for Runoff Treatment BMPs](#) for bypass design information.

### Additional Requirements

Federal, state, or local jurisdictions may impose additional treatment or siting requirements to achieve specific water quality protection or restoration goals. Check with the local jurisdiction for any additional requirements.

### ***Applicability to UIC Wells***

Runoff treatment requirements for UIC wells, other than infiltration trenches, are determined per the criteria in [5.6 Subsurface Infiltration \(Underground Injection Control Wells\)](#). The narrative and tables in [5.6 Subsurface Infiltration \(Underground Injection Control Wells\)](#) describe the pollutant loading source area and vadose zone treatment capacity classifications that are used in determining these requirements.

UIC wells that discharge into geologic matrices without sufficient treatment capacity must be preceded by runoff treatment in accordance with [2.7.6 Core Element #5: Runoff Treatment](#). Note that discharges to drywells that contain process water or any other discharges besides stormwater require individual permits. Discharges of stormwater from certain industrial and commercial sites to UIC wells are prohibited (see the complete list in [5.6 Subsurface Infiltration \(Underground Injection Control Wells\)](#)). Discharges of process water to UIC wells are also prohibited. Additional local requirements may apply for any discharge to a drywell or other infiltration BMPs.

### ***Applicability to Wetlands***

Runoff treatment BMPs are not allowed within a wetland or its natural vegetated buffer except for the following conditions:

- Necessary conveyance systems approved by the local jurisdiction
- As allowed in a wetland mitigation plan
- When the requirements below are met

A wetland can be considered for use in stormwater treatment if it meets the criteria for “Hydrologic Modification of a Wetland” in [2.7.7 Core Element #6: Flow Control](#) and is either:

- A Category 4 wetland according to the Wetland Rating System for Eastern Washington ([Ecology, 2014](#)); or
- A Category 3 wetland according to the Wetland Rating System for Eastern Washington ([Ecology, 2014](#)) and the wetland has been previously disturbed by human activity, as evidenced by agriculture, fill areas, ditches or the wetland is dominated by introduced or invasive weedy plant species as identified in the rating analysis.

Basic treatment is required prior to discharge to Category 3 wetlands. A Category 3 wetland that meets the above requirements may be used to meet metals treatment requirements. Oil control is required for all discharges to wetlands from high-use sites (see definition in the glossary).

**Caution:** Wetlands may accumulate the salts in anti-icing and deicing chemicals, so use of such chemicals should be limited in the areas discharging to the wetland (see [2.7.4 Core Element #3: Source Control of Pollution](#)).

Mitigation is required for the impact of using a wetland as a runoff treatment BMP. Appropriate measures include enhancement, expansion, and/or preservation of a buffer around the wetland.

## **Supplemental Guidelines**

See [Chapter 4 - Hydrologic Analysis and Design](#) and [Chapter 5 - Runoff Treatment BMP Design](#) for detailed guidance on selection, design, construction, operation, and maintenance of runoff treatment BMPs. The water quality design volumes and flow rates are intended to size facilities to capture and effectively treat at least 90% of the average annual runoff volume in eastern Washington.

Additional exemptions from metals treatment requirements for rural roads or small isolated commercial projects located outside Urban Growth Area (UGA) boundaries may be considered on a case-by-case basis. Some receiving waters will have sufficient capacity to dilute the metals concentration from the cumulative stormwater discharges so water quality standards are not violated. Other water bodies will not have sufficient mixing and dilution capacity. In making a determination, the local jurisdiction or other agency reviewing the project should consider:

- The average lowest monthly flow in the water body
- The existing and expected metals contributions from the surrounding area based on the zoning
- Probable future land use
- Whether a water quality violation is likely to occur during a thunderstorm following an extended period of dry weather

If the runoff generated from a project site by the water quality design storm discharges to a conveyance system that does not reach a surface water body or UIC well, then basic treatment is not required. The analysis must consider all of the water flowing to the conveyance system, not just the water from the project site.

Project designers are encouraged to consider site grading, conveyance, and other design specifications that separate NPGIS from PGIS runoff to avoid treating all of the runoff from the site. Designers are also encouraged to keep PGIS runoff from portions of the site that require oil control or metals treatment separate from PGIS areas that need only basic treatment where it might be possible to avoid treating all of the runoff from the site to the higher standard.

## **Recommendations for Local Jurisdictions**

During plan review, local jurisdictions should evaluate whether the objectives of Core Element #5 have been met. Staff should be aware of any current water cleanup plans (including TMDLs), sole-source aquifer protection measures, wellhead protection areas, or other requirements to protect or restore water quality.

Each local jurisdiction should identify a preferred method for calculating (1) runoff volumes and (2) flow rates to ensure consistent sizing of treatment BMPs in their jurisdiction and to facilitate plan review. Local jurisdictions may choose to accept road projects designed per another approved equivalent manual. Projects using BMPs in the latest approved edition of the WSDOT *Highway Runoff Manual* should still apply the Core Elements for new development and redevelopment in this manual. Proponents of unique or complex projects may wish to use other methodologies, and staff should work with those designers to ensure that the objectives of Core Element #5 are met.



**For more information:** Local jurisdictions are encouraged to assist in development and testing of new treatment methodologies. See [5.11 Emerging Technologies](#) for more information.

## 2.7.7 Core Element #6: Flow Control

### Objective

The purpose of flow control is to mitigate to the maximum extent practicable the impacts of increased stormwater runoff volumes and flow rates on streams in eastern Washington. The intent of Core Element #6 is to prevent cumulative future impacts due to urban runoff and protect stream morphology. The impacts of prior development and/or flow modifications in eastern Washington are not addressed in this manual.

Wherever possible, infiltration is the preferred method of flow control for urban runoff. Some stream habitat problems in eastern Washington result from reduced instream flows during the hot summer months. Flow control using detention basins will not address this issue and may exacerbate it. The cumulative effect of infiltrating urban runoff, where feasible, should have a neutral or possibly beneficial effect.

Core Element #6 is targeted to smaller water bodies, especially first to third order streams or water bodies with contributing watershed areas of < 100 square miles. These smaller streams and water bodies are more susceptible than larger streams and water bodies to changes in runoff patterns caused by development.

Core Element #6 is also targeted to wetlands. Discharges to wetlands should maintain the hydrology (depth and duration of inundation) of the existing condition in order to protect the unique vegetation and other characteristics necessary to support existing and designated uses.

**Note:** Design specifications for conveyance and flood prevention are determined by local jurisdictions. Core Element #6 does not address those issues.

### Exemptions

Flow control is not required for all discharges to surface waters in eastern Washington because flow control is not always needed to protect stream morphology. The exemptions listed in this section are provided to assist local jurisdictions in determining which projects should be subjected to Core Element #6. Any project may be subject to local requirements for flow control to prevent flooding.

In consideration of other environmental issues, a local jurisdiction may wish to require flow control for one or more of the types of projects or exempt water bodies listed in this section. Conversely, following analysis of a particular water body and/or its watershed, a local jurisdiction may determine that flow control is not necessary for certain discharges or to protect certain water bodies, or decide to provide a regional stormwater BMP instead of requiring site-by-site flow control BMPs. See additional information in the Supplemental Guidelines section.

The following projects and discharges are exempt from flow control requirements to protect stream morphology. Runoff treatment may still be required per [2.7.6 Core Element #5: Runoff Treatment](#). Local jurisdictions may override any of the following exemptions:

- Any project able to disperse, without discharge to surface waters, the total 25-year runoff volume for the proposed development condition on property that is under the functional

control of the project proponent. See the guidelines for dispersion in [6.5 Dispersion BMPs](#), particularly [BMP F6.42: Full Dispersion](#).

- A road project able to disperse, without discharge to surface waters, the total 25-year runoff volume for the proposed development condition on land for which this use has been specifically authorized by the controlling entity. See the guidelines for dispersion in [6.5 Dispersion BMPs](#) and the latest approved edition of the WSDOT *Highway Runoff Manual*.
- A project constructing < 10,000 sf of total new impervious and replaced impervious surfaces. Local jurisdictions may establish a different impervious surface area threshold (see [2.7.9 Core Element #8: Local Requirements](#)).
- A project discharging to stream reaches consisting primarily of irrigation return flows and not providing habitat for fish spawning and rearing.
- A project discharging directly to the following:
  - Any of the following exempt surface waters (rivers and lakes):
    - Asotin Creek downstream of confluence with George Creek
    - Banks Lake
    - Bumping River downstream of confluence with American River
    - Lake Chelan
    - Cle Elum River downstream of Cle Elum Lake
    - Columbia River
    - Colville River downstream of confluence with Chewelah Creek
    - Grande Ronde River
    - Kettle River downstream of confluence with Boulder Creek
    - Klickitat River downstream of confluence with West Fork
    - Latah Creek (formerly called Hangman Creek) downstream of confluence with Rock Creek (in Spokane County)
    - Little Spokane River downstream of confluence with Deadman Creek
    - Lower Crab Creek
    - Methow River downstream of confluence with Early Winters Creek
    - Moses Lake
    - Naches River downstream of confluence with Bumping River
    - Okanogan River

- Palouse River downstream of confluence with South Fork Palouse River
- Pend Oreille River
- Potholes Reservoir
- Rock Creek (in Whitman County) downstream of confluence with Cottonwood Creek
- Similkameen River
- Snake River
- Spokane River
- Teanaway River downstream of confluence of north and west forks
- Tieton River downstream of Rimrock Lake
- Toppenish Creek downstream of confluence with Wanity Slough
- Touchet River downstream of confluence with Patit Creek
- Tucannon River downstream of confluence with Pataha Creek
- Walla Walla River downstream of confluence with Mill Creek
- Wenatchee River downstream of confluence with Icicle Creek
- Yakima River downstream of Lake Easton

**Note:** This list of exempt water bodies generally consists of fifth or greater order stream channels (determined from a 1:150,000-scale map) and lakes with watershed areas much > 100 square miles. The list is subject to change as more information is gathered. See [Supplemental Guidelines](#) for an alternative definition of a “large” exempt stream.

- Reservoirs on the Columbia, Snake, Pend Oreille, or Spokane Rivers
- Other reservoirs with outlet controls that are operated for varying discharges to the downstream reaches as for hydropower, flood control, irrigation, or drinking water supplies. Uncontrolled, flow-through impoundments are not exempt.

Projects may also discharge to these waters through a publicly owned conveyance system with sufficient capacity. Permission must be granted by the owner/operator of the conveyance system.

In order to be exempt, the discharge must meet all of the following requirements:

- The project area must be drained by a conveyance system that consists entirely of man-made conveyance elements (e.g., pipes, ditches, outfall protection).
- The conveyance system must extend to the ordinary high water line of the receiving water, or (in order to avoid construction activities in sensitive areas) flows are properly dispersed before

reaching the buffer zone of the sensitive or critical area.

- Any erodible elements of the conveyance system for the project area must be adequately stabilized to prevent erosion.
- Stormwater runoff should not be diverted from the project area to an existing wetland, stream, or near-shore habitat sufficient in quantities large enough to result in significant adverse impact. Adverse impacts are expected from uncontrolled flows causing a significant increase or decrease in the 1.5- to 2-year peak flow rate.
- A project discharging to a wetland that has no surface water outlet does not need to meet the flow control requirements to protect stream morphology. Flow control may still be required to protect the wetland. See [2.7.5 Core Element #4: Preservation of Natural Drainage Systems](#) and also [Applicability to Wetlands](#).
- A project located at a site with < 10 inches of average annual rainfall that discharges to a seasonal stream that is not connected via surface flow to a nonexempt surface water by runoff generated by the 2-year Type IA design storm.
- A project that discharges to a stream that flows only during runoff-producing events. The runoff carried by the stream following the 2-year regional storm in Climate Regions 1 and 4, or the Type IA storm in Climate Regions 2 and 3, must not discharge via surface flow to a nonexempt surface water. The stream may carry runoff during an average annual snowmelt event but must not have a period of base flow during a year of normal precipitation.

Any additional exemptions to and overriding of Core Element #6 are left to the local jurisdiction based on basin planning and studies. See [Supplemental Guidelines](#). These plans and studies should consider: the total impervious area in the watershed under likely future development scenarios, other possible development impacts or contributions toward increasing future streamflow volumes and changing the stream channel morphology and/or increasing the potential for stream bank erosion, other potential cumulative downstream effects, and unique habitat characteristics.

## **Guidelines**

Nonexempt projects shall construct stormwater flow control BMPs for any discharge of stormwater directly, or through a drainage system, into a surface water. Discharges to ground water are exempt from the flow control requirements of this manual, but may be subject to design specifications or other restrictions established by local jurisdictions. Flow control BMPs shall be selected, designed, constructed, operated, and maintained according to the criteria in [Chapter 4 - Hydrologic Analysis and Design](#) and [Chapter 6 - Flow Control BMP Design](#). The requirements in this section apply to projects that discharge stormwater into a nonexempt surface water, either directly or indirectly through a natural or man-made drainage system. See the list of exempt surface waters in the Exemptions subsection for Core Element #6.

In order to prevent localized erosion, energy dissipation at the point of discharge is required for all projects unless site-specific conditions warrant an exception (see [2.7.5 Core Element #4: Preservation of Natural Drainage Systems](#)).

**Note:** When Core Element #6 is required, [2.7.8 Core Element #7: Operation and Maintenance](#) is also required.

## **Hydrologic Analysis**

Estimate predevelopment or existing and proposed development condition runoff volumes and flow rates using the methods described in [Chapter 4 - Hydrologic Analysis and Design](#) or by an alternative method approved by the local jurisdiction. Existing conditions at the project site are used for the analysis unless the local jurisdiction has imposed other requirements. Design storms for determining both volumes and flow rates are described in [4.3.2 Distributions and Applicability](#).

## ***Applicability to UIC Wells***

Core Element #6 does not apply to projects using drywells and other UIC wells. See [5.6 Subsurface Infiltration \(Underground Injection Control Wells\)](#) for UIC well rules, guidelines, and requirements; and see [Chapter 6 - Flow Control BMP Design](#) for supplemental guidance on sizing drywells.

To meet Core Element #6, designers may use infiltration BMPs that are also considered UIC wells. These BMPs must be designed to meet the flow control requirements listed in the guidelines section for Core Element #6 and must be registered as a UIC well.

## ***Applicability to Nonexempt Streams and Lakes***

The Phase II Municipal Stormwater National Pollutant Discharge Elimination System (NPDES) Permit for eastern Washington (Municipal Stormwater Permit) requires that new development and redevelopment projects retain the 10-year storm on-site without any discharge to the MS4. See Section S5.B.5.a.ii (b) (2) of the Municipal Stormwater Permit and local jurisdiction requirements for any additional flow control requirements. For example, a local jurisdiction may also require the design of flow control BMPs to limit the peak flow rates of a different return interval (e.g., 25-year, 50-year, or 100-year) to the prescribed target flow rates.

## ***Applicability to Wetlands***

A wetland receiving stormwater from a new development or redevelopment project can be considered for hydrologic modification if it is a Category 3 or 4 wetland according to the *Washington State Wetland Rating System for Eastern Washington* ([Ecology, 2014](#)), and the following criteria are met:

- There is good evidence that the natural hydrologic regime of the wetland can be restored by augmenting its water supply with excess stormwater runoff, or the wetland is under imminent threat exclusive of stormwater management and could receive greater protection if acquired for a stormwater management project rather than left in existing ownership.
- The runoff is from the same natural drainage basin; the wetland lies in the natural routing of the runoff, and the site plan allows runoff discharge at the natural location. Exceptions may be made for regional facilities planned by the local jurisdiction, but the wetland should receive water from sites in the same watershed.

Hydrologic modification shall not be allowed if the wetland is classified as Category 1 or Category 2 according to the *Washington State Wetland Rating System for Eastern Washington* ([Ecology, 2014](#)) unless the project proponent demonstrates that preferred methods of excess stormwater disposal (e.g., infiltration) are not possible at the site and that other options (e.g., evaporation) would result in more damage to the wetland by limiting inflow.

Mitigation shall be required for the impact of hydrologic modification on a wetland. Appropriate measures include expansion, enhancement and/or preservation of a buffer around the wetland.

### **Supplemental Guidelines**

Local jurisdictions may adopt a conservative, restricted set of curve numbers for estimating runoff volumes and flow rates from predevelopment or existing conditions. Ecology recommends that local jurisdictions consider applying native vegetation predevelopment conditions. Native vegetation generally reduces stormwater runoff during rain-on-snow events, and changes in cover should be a primary consideration in evaluating the change in runoff volumes caused by development in many areas of eastern Washington.

The local jurisdiction or project proponent may evaluate the substrate of a stream to determine whether the requirement to release the 2-year peak volume for the proposed development condition at 50% of the 2-year peak flow rate for the predevelopment or existing can and should be adjusted. The release rate of 50% of the 2-year peak flow rate is a middle ground that should be protective for most streams and was chosen for its ease of application. However, for a highly erodible substrate such as sand or loess the target should be closer to 20% of the 2-year peak flow rate. For an erosion-resistant substrate such as clay, the target could be closer to 90% of the 2-year peak flow rate. The substrate should be evaluated for a minimum distance of one-half mile downstream of the proposed discharge. The focus of the study should be on evaluating the erodibility of the downstream substrate under the probable build-out conditions to at least the next significant natural inflow, and the results considered together with studies and findings by ([Leopold et al., 1964](#)), ([Williams, 1978](#)), ([Harvey and Watson, 1986](#)), ([Hammer, 1972](#)), ([Bledsoe and Watson, 2001](#)), ([Booth, 1997](#)), and ([Cappuccitti and Page, 2000](#)) in making the determination.

In order to reduce potential effects of increased water temperatures during the hot summer months, projects should consider withholding the total runoff volume for the proposed development condition from the 2-year short-duration storm in the detention BMP for infiltration (preferred) and/or evaporation.

To meet the flow control target, optimal placement of multiple small-scale retention/infiltration BMPs within a contributing area may require less total storage capacity than a single detention pond at the drainage outlet.

Local jurisdictions may require detention basins to be designed to match the 10-year peak flow in addition to 50% of the 2-year peak flow and the full 25-year peak flow. The purpose of this design specification is to improve the function of the detention basin in matching predeveloped or existing peaks between 50% of the 2-year peak flow and the full 25-year peak flow and possibly reduce the size of the detention BMP.

Regulatory agencies and local jurisdictions may exempt additional streams from Core Element #6 by applying the following definition of a “large” stream (see [Exemptions](#)):

- Any river or stream that is fifth order or greater as determined from a 1:24,000 scale map
- Any river or stream that is fourth order or greater as determined from a 1:100,000 or larger scale map

The maps should be standard U.S. Geological Survey (USGS) maps or geographic information systems (GIS) data sets derived from USGS base maps. The other provisions of the exemptions

must still be applied, and consideration should also be given to other information about the stream bed material and downstream channel conditions.

Local jurisdictions may engage in basin planning, studies, zoning restrictions, etc., that result in watershed- or reach-specific changes to the requirements of Core Element #6. These studies may also address the question of whether problems related to low streamflow may be aggravated by flow control requirements for certain streams.

Additional exemptions to Core Element #6 may be granted to projects discharging to surface water where the long-term, projected total man-made impervious surface area in the contributing watershed is < 10% of the total area, and at least 65% of the native vegetation is retained. This determination must be based on current and probable future zoning requirements and build-out conditions as determined through a basin analysis conducted by the local jurisdiction. This analysis could also be done for a road project in a rural area, although dispersion (see [Chapter 6 - Flow Control BMP Design](#), particularly [BMP F6.42: Full Dispersion](#)) would be preferable to conveyance of runoff to a nonexempt stream.

Local jurisdictions may also exempt a project discharging to a seasonal stream from Core Element #6 where downstream analysis has concluded that the stream channel morphology was established by past glacial or catastrophic flooding events and the stream channel is capable of carrying a larger frequent streamflow without incision or widening. The stream must not discharge via surface flow to a nonexempt stream.

### **Suggested Approach for Additional Exemptions**

In order for a jurisdiction to exempt other water bodies or reaches from flow control requirements, the local jurisdiction must provide scientific justification for the exemption. The exemption may apply only to restricted areas within a watershed. This means the jurisdiction must determine that under probable build-out conditions in the watershed, disregarding Core Element #6 will not adversely affect the receiving waters. Adverse impacts are expected from uncontrolled flows causing a significant increase in the 1.5- to 2-year recurrence interval peak instream flow rate. Documentation must be provided showing that significant increases in instream flow rates will not take place under the maximum projected development condition for the contributing watershed. The documentation should include at least the following elements:

- Analysis of available historical streamflow data for the water body and hydrologic modeling of the watershed under both undeveloped and projected future build-out conditions. For a lake, the outlet stream may be the primary water body of interest for flow control.
- Observation of downstream channel conditions, including: assessment of the geomorphic conditions, instream habitat, and resident benthic community.
- Maps or geographic analyses showing the following:
  - Current and probable future zoning with definitions for density of development in each category
  - The portion of watershed under the jurisdiction of the petitioner

- Projected total impervious surface areas
- Area of native vegetation preserved under probable future build-out conditions
- Description of the watershed planning efforts undertaken by the petitioning jurisdiction and cooperative planning efforts undertaken with other agencies and jurisdictions with authority in the watershed.

A local jurisdiction also should consider and use the information provided in this section when planning and designing a regional flow control BMP, and in particular for determining the appropriate capacity and operation requirements of the BMP.

Local jurisdictions may also allow a project generating < 0.1 cfs increase in runoff for the 25-year storm to be exempt.

### ***Recommendations for Local Jurisdictions***

During plan review, local jurisdictions should evaluate whether the objectives of Core Element #6 have been met. Local jurisdictions should establish design criteria for conveyance systems, flood protection, and drywells and other UIC wells.

In particular, local jurisdictions should determine whether the default design criterion of the 25-year runoff volume for detention/retention flow control BMPs is appropriate to meet local flood protection goals and, if it is not, establish a different upper boundary design criterion.

Local jurisdictions should also determine whether the default design criteria for drywells in [Chapter 6 - Flow Control BMP Design](#) are appropriate to meet local goals. In particular, knowledge of local geology and ground water levels may lead to specific siting and infiltration capacity requirements, or to development of presumptive infiltration rates for certain areas in the local jurisdiction. These criteria and local information should be made readily available to designers.

## **2.7.8 Core Element #7: Operation and Maintenance**

### ***Objective***

Inadequate maintenance or improper operation is a common cause of failure for stormwater facilities, including drywells. To ensure that stormwater control facilities are adequately maintained and properly operated, projects are required to plan for and perform appropriate preventive maintenance and performance checks at regular intervals.

### ***Guidelines***

Where structural BMPs are required, projects shall operate and maintain the facilities in accordance with an O&M manual that is prepared in accordance with the provisions in [Chapter 5 - Runoff Treatment BMP Design](#) and [Chapter 6 - Flow Control BMP Design](#). The O&M manual shall address all proposed stormwater facilities and BMPs, and identify the party (or parties) responsible for maintenance and operation. The O&M manual must also address the long-term funding mechanism that will support proper O&M. At private facilities, a copy of the O&M manual shall be retained on-site or within reasonable access to the site, and shall be transferred with the property to the new owner. For public facilities, a copy of the O&M manual shall be retained in the appropriate department. A log



of maintenance activity that indicates what actions were taken shall be kept and be available for inspection by the local jurisdiction.

The local jurisdiction may develop a generic O&M manual for BMPs that are commonly used in public projects. Commercial and residential property developers may also develop generic O&M manuals for BMPs that are commonly used in their projects. Checklists of O&M actions and procedures may be helpful to the operators.

### ***Applicability to UIC Wells***

See [5.6 Subsurface Infiltration \(Underground Injection Control Wells\)](#) for requirements for discharges to UIC wells.

### ***Supplemental Guidelines***

The description of each BMP in [Chapter 5 - Runoff Treatment BMP Design](#), [Chapter 6 - Flow Control BMP Design](#), and [Chapter 7 - Construction Stormwater Pollution Prevention](#) includes a section on maintenance. [Chapter 6 - Flow Control BMP Design](#) includes a schedule of maintenance standards for drainage facilities. Local jurisdictions should consider more detailed requirements for maintenance logs as part of [2.7.9 Core Element #8: Local Requirements](#), such as a record of where wastes were disposed of.

O&M information for conveyance systems should also be developed. Conveyance is not discussed in this guidance, but proper operation of the conveyance system is integral to the successful operation of the runoff treatment and flow control BMPs.

### ***Recommendations for Local Jurisdictions***

As part of plan review and approval, local jurisdictions should consider a performance bond for operation and maintenance of BMPs at the site. Staff can enforce proper operation and maintenance requirements during site inspections or in response to complaints about a site or BMP.

## **2.7.9 Core Element #8: Local Requirements**

### ***Objective***

This manual describes the minimum Core Elements for stormwater management at project sites in eastern Washington. Due to the variety in hydrology, climate, topography, soils, and priorities for protection of water resources in some areas of eastern Washington, discretion is provided to local jurisdictions in expanding and implementing stormwater requirements.

### ***Guidelines***

All projects, regardless of size, shall meet additional local requirements for flood control, discharges to wetlands, protection of sensitive areas, basin plans, aquifer protections, special water quality requirements based on a TMDL or water cleanup plan, or for any other purpose. Check with the local jurisdiction for the local requirements that are applicable to your project. See also [Chapter 8 - Source Control](#), which provides guidance for selecting BMPs to meet [2.7.4 Core Element #3: Source Control of Pollution](#). [Chapter 8 - Source Control](#) can help local jurisdictions and businesses to control urban sources of conventional and toxic pollutants in stormwater and add them in meeting state water quality standards to protect beneficial uses of receiving waters.

## ***Applicability to UIC Wells***

See [5.6 Subsurface Infiltration \(Underground Injection Control Wells\)](#) for requirements for discharges to UIC wells.

## ***Recommendations for Local Jurisdictions***

The following list provides examples of local standards, requirements, preferences, and tools to simplify implementation of this manual that may be considered or developed at the local jurisdiction level:

- Simplified or templated SSPs or Construction Stormwater Pollution Prevention Plans (SWPPPs) to ease the designer's process of developing those documents for specific types of projects
- Clear, jurisdiction-specific submittal requirements for SSPs and SWPPPs
- Actions required under current water cleanup plans (such as TMDLs) or other measures necessary to protect or restore water quality
- Sole-source aquifer protection requirements and/or wellhead protection area requirements
- Preferred design storm and hydrologic analysis methods for calculating runoff volumes and flow rates to ensure consistent sizing of runoff treatment BMPs within the jurisdiction (based on the guidance included in [Chapter 4 - Hydrologic Analysis and Design](#))
- A determination of whether a downstream jurisdiction's requirements may apply when jurisdictions have interconnected storm sewer systems (neighboring jurisdictions should work together to establish consistent design criteria for stormwater BMPs since hydrologic conditions are likely to be similar)
- Information on LID standards, requirements, or technical guidance for preserving native vegetation and reducing the amount of impervious surface area
- Preferred field and laboratory testing procedures for infiltration testing (based on the guidance included in [6.3 Infiltration BMPs](#), along with [6.B.3 Recommended Field Test Procedures](#) and [6.B.4 Recommended Laboratory Test Procedures](#))
- Design criteria for conveyance systems and flood prevention
- Design criteria for drywells, particularly infiltration capacity requirements and related local geologic information
- Design requirements for snowmelt, particularly BMP sizing requirements that factor snowmelt or rain-on-snow in determining appropriate design flows
- Plant requirements or recommended planting lists or methods
- Any alternative impervious area or other threshold below which projects are not required to provide flow control BMPs
- Retrofit requirements (if applicable)
- Additional exemptions (or exceptions) to the list of exempt surface waters

- Detailed operation and maintenance requirements
- Any other adjustments to the Core Elements or to the redevelopment requirements in [2.6 Redevelopment](#)

*This page has been intentionally left blank for double-sided printing.*

# Chapter 3 - Preparation of Stormwater Site Plans

## 3.1 Introduction

The Stormwater Site Plan (SSP) is a comprehensive report containing all of the technical information and analysis necessary for regulatory agencies to evaluate a proposed new development or redevelopment project for compliance with stormwater requirements. Preparation of an SSP constitutes [2.7.3 Core Element #2: Construction Stormwater Pollution Prevention](#). Contents of the SSP will vary with the type and size of the project, individual site characteristics, and special requirements of the local jurisdiction.

The scope of the SSP will also vary depending on the applicability of Core Elements (see [Chapter 2 - Core Elements for New Development and Redevelopment](#)).

This chapter describes the contents of the SSP and provides a general procedure for how to prepare the plan. The specific Best Management Practices (BMPs) and design methods and standards to be used are contained in [Chapter 4 - Hydrologic Analysis and Design](#) through [Chapter 8 - Source Control](#). Guidelines for selecting runoff treatment and flow control BMPs are provided in [Chapter 4 - Hydrologic Analysis and Design](#), [Chapter 5 - Runoff Treatment BMP Design](#), and [Chapter 6 - Flow Control BMP Design](#). The content of, and the procedures for preparing a Construction Stormwater Pollution Prevention Plan (SWPPP) are covered in detail in [Chapter 7 - Construction Stormwater Pollution Prevention](#). Guidelines for selecting source control BMPs are provided in [Chapter 8 - Source Control](#).

The goal of this chapter is to provide a framework for uniformity in plan preparation. Such uniformity will promote predictability throughout the region and help secure prompt governmental review and approval. Properly drafted engineering plans and supporting documents will also facilitate the operation and maintenance of the proposed system long after its review and approval.

State law requires that engineering work be performed by or under the direction of a licensed engineer in the state of Washington. Plans involving construction of runoff treatment BMPs, flow control BMPs, structural source control BMPs, or drainage systems generally involve engineering principles and shall be prepared by or under the direction of a licensed engineer in the state of Washington. Construction SWPPPs that involve engineering calculations must also be prepared by or under the direction of a licensed engineer in the state of Washington.

## 3.2 Stormwater Site Plans: Step by Step

### 3.2.1 Introduction

The development of a Stormwater Site Plan (SSP) consists of eight steps:

- [3.2.2 Step 1: Site Analysis: Collect and Analyze Information on Existing Conditions](#)
- [3.2.3 Step 2: Prepare Preliminary Development Layout](#)

- [3.2.4 Step 3: Perform Off-Site Analysis](#)
- [3.2.5 Step 4: Determine Applicable Core Elements](#)
- [3.2.6 Step 5: Prepare a Permanent Stormwater Control Plan](#)
- [3.2.7 Step 6: Select Construction Stormwater Pollution Prevention BMPs](#)
- [3.2.8 Step 7: Complete the Stormwater Site Plan](#)
- [3.2.9 Step 8: Check Compliance With All Applicable Core Elements](#)

The level of detail needed for each step depends on the project size, as explained in the individual steps. A narrative description of each of these steps follows.

### **3.2.2 Step 1: Site Analysis: Collect and Analyze Information on Existing Conditions**

Collect and review information on the existing site conditions including topography, drainage patterns, soils, ground cover, presence of critical areas, adjacent areas, existing development, existing stormwater BMPs, adjacent on- and off-site utilities, and prior disturbance of the site. Disturbance may cause changes in soil profiles, permeability, water holding capacity and transmissivity, tilth, native vegetation, and fertility. Analyze the data to determine the site limitations, including the following:

- Areas with high potential for erosion and sediment deposition (based on soil properties, slope, etc.)
- Locations of sensitive and critical areas (e.g., vegetative buffers, wetlands, steep slopes, floodplains, geologic hazard areas, streams, etc.)
- Observation of potential runoff contribution from off-site basins
- Adjacent properties and/or projects that have a history of stormwater problems, noting whether the cause of the problem(s) has been determined
- Adjacent properties and/or projects where geotechnical investigations have identified shallow bedrock, high groundwater, seasonally perched groundwater, or clay lenses in the substrata

Delineate these areas on the site map required as part of Step 3, Prepare a Permanent Stormwater Control Plan. Prepare an existing conditions summary that will be submitted as part of the SSP. Part of the information collected in this step should be used to help prepare the Construction Stormwater Pollution Prevention Plan (SWPPP).

### **3.2.3 Step 2: Prepare Preliminary Development Layout**

Based on the analysis of existing site conditions, locate the buildings, roads, parking lots, landscaping features, and preliminary locations of stormwater BMPs for the proposed development. Consider the following points when laying out the site:

- Fit development to the terrain to minimize land disturbance; confine construction activities to the least area necessary, and away from critical areas.
- Preserve areas with native vegetation (especially forested areas) as much as possible.
- On sites with a mix of soil types, locate impervious areas over less permeable soil, try to restrict development over more porous soils or take advantage of them by locating infiltration BMPs over them.
- Cluster buildings together.
- Minimize impervious areas.
- Maintain and utilize natural drainage patterns.
- Identify existing utilities and proposed utility corridors.

See [Appendix 3-D: Additional Guidance on Low Impact Development Site Planning Principles and Design Strategies](#) for additional guidance on site planning principles and design strategies.

### **3.2.4 Step 3: Perform Off-Site Analysis**

An off-site analysis is required as part of [2.7.5 Core Element #4: Preservation of Natural Drainage Systems](#). Development projects that propose to discharge stormwater off-site are required to submit an off-site analysis report that assesses the potential off-site water quality, erosion, slope stability, and drainage impacts associated with the project and that proposes appropriate mitigation of those impacts. An initial qualitative analysis should extend downstream for the entire flow path from the project site to the receiving water, or up to 1 mile or to a point where the impact on receiving waters are minimal or nonexistent, as determined by the local jurisdiction. If a receiving water is within 0.25 miles, the analysis should extend within the receiving water to 0.25 miles from the project site. The analysis should extend 0.25 miles beyond any improvements proposed as mitigation. The analysis should extend upstream to a point where backwater effects created by the project cease. Upon review of the qualitative analysis, the local jurisdiction may require that a quantitative analysis be performed. A full description of a typical off-site analysis procedure, along with a sample checklist to aid in the preparation and review of an off-site analysis, are included in [Appendix 3-A: Off-Site Analysis](#).

### **3.2.5 Step 4: Determine Applicable Core Elements**

The Phase II Municipal Stormwater National Pollutant Discharge Elimination System (NPDES) Permit for eastern Washington or local jurisdiction establishes project size thresholds for the application of Core Elements (in [Chapter 2 - Core Elements for New Development and Redevelopment](#)), to new development and redevelopment projects. The designer of the SSP should meet with local officials to agree on the applicable Core Elements, prior to proceeding to the next step.

### **3.2.6 Step 5: Prepare a Permanent Stormwater Control Plan**

Select stormwater BMPs (all projects) and runoff treatment and flow control BMPs (projects subject to [2.7.6 Core Element #5: Runoff Treatment](#) and/or [2.7.7 Core Element #6: Flow Control](#)) that will serve the project site in its developed condition. The selection process for runoff treatment and flow

control BMPs is presented in detail in [Chapter 5 - Runoff Treatment BMP Design](#) and [Chapter 6 - Flow Control BMP Design](#).

A preliminary design of the BMPs is necessary to determine how they will fit within and serve the entire preliminary development layout. After a preliminary design is developed, the designer may want to reconsider the site layout to reduce the need for construction of BMPs, or the size of the BMPs by reducing the amount of impervious surfaces created and increasing the areas to be left undisturbed. After the designer is satisfied with the BMP selection, the information must be presented in a Permanent Stormwater Control Plan, which typically consists of a drainage report and a set of construction plans.

### ***Drainage Report***

The drainage report is to be inclusive, clear, legible, and reproducible, with a complete set of drainage computations and stamped by a licensed engineer in the state of Washington. The computations are to be presented in a rational format with information included so as to allow a reviewer to be able to reproduce the same results. The computations should provide sufficient information for an unbiased third party to be able to review the report and determine that all applicable standards have been met. All assumptions and computer input and output data, and variables listed in the computer printouts, should be clearly identified. Computer printouts should clearly show which subbasin(s) they apply to and the design storm event identified thereon if multiple storm events are addressed in the design. Copies of design charts, nomographs, or other design aids used in the analysis should be included in the calculations.

All relevant geotechnical information related to the project and all site-specific soil logs and subsurface testing information should be included in the drainage report or provided in a separate report prepared and stamped by the geotechnical engineer or licensed engineering hydrogeologist.

The drainage report should also include a basin map. Under most conditions both a predevelopment basin map and a postdevelopment basin map should be provided, unless deemed unnecessary by the local jurisdiction. See [Appendix 3-B: Basin Maps](#) for a checklist of items to be included on the basin map.

The drainage report is to identify existing drainage BMPs which are clearly inadequate or need repair, such as collapsed culverts or culverts with a substantial amount of debris. The condition and capacity of existing drainage BMPs located on-site, which are proposed for use by the development, should be evaluated and disclosed in the drainage report.

Calculations for detention and infiltration ponds sized to meet [2.7.6 Core Element #5: Runoff Treatment](#) and/or [2.7.7 Core Element #6: Flow Control](#) may include the following: inflow and outflow hydrographs, level-pool routing calculations, a listing of the maximum water surface elevation, a pond volume rating table (e.g., stage vs. storage), and discharge rating table (e.g., stage versus discharge). Each hydrograph and level-pool routing calculation sheet is to have clearly marked: the design storm event, the applicable subbasin(s), and the pond identification name, which corresponds with the basin map and plans.

The drainage submittal should incorporate all calculations for the determination of the required size of the systems. Typical calculations include the following:



- Hydrologic computations:
  - Drainage basin (and subbasin) delineation
  - Model output reports summarizing input parameters and results
- Hydraulic computations:
  - Inlet capacities
  - Detention/retention storage capacities
  - Culvert and pipe system capacities and outlet velocities
  - Ditch capacities and velocities
- Map with the project plotted thereon

A copy of applicable floodplain maps, or studies within the project area should be included in the drainage report.

### ***Construction Plans***

Construction plans should be prepared for all open and closed drainage systems. This information should be presented in a clear, concise manner that can be easily followed, checked, and verified. All pipes, culverts, catch basins, channels, swales, and other stormwater conveyance appurtenances must be clearly labeled. The plans should call out sufficient hydraulic and physical data for construction of the system and future evaluation of the design. An example checklist describing many of the items typically shown on construction plans is included in [Appendix 3-C: Stormwater Construction Plans](#). Designers should consult local jurisdiction requirements for specific information to include on construction plans.

### **3.2.7 Step 6: Select Construction Stormwater Pollution Prevention BMPs**

A Construction SWPPP may be required as part of [2.7.3 Core Element #2: Construction Stormwater Pollution Prevention](#). Guidance is also provided for construction stormwater pollution prevention for small projects.

#### ***Large-Project Construction SWPPP***

The Construction SWPPP must contain sufficient information to satisfy the local jurisdiction that the potential pollution problems have been adequately addressed for the proposed project. An adequate Construction SWPPP includes a narrative and drawings. The narrative is a written statement that explains the pollution prevention decisions made for a particular project. The narrative contains concise information concerning existing site conditions, construction schedules, and other pertinent items that are not contained on the drawings. The drawings and notes describe where and when the various BMPs should be installed, the performance the BMPs are expected to achieve, and actions to be taken if the performance goals are not achieved.

The 13 Elements listed in [2.7.3 Core Element #2: Construction Stormwater Pollution Prevention](#) must be considered in the development of the Construction SWPPP unless site conditions render the element unnecessary and the exemption from that element is clearly justified in the narrative of the Construction SWPPP. These elements are described in detail in [Chapter 7 - Construction Stormwater Pollution Prevention](#). They cover the general water quality protection strategies of limiting site impacts, preventing erosion and sedimentation, and managing activities and sources.

On construction sites that discharge to receiving water, the primary consideration in the preparation of the Construction SWPPP is compliance with the State Water Quality Standards. The step-by-step procedure outlined in [Chapter 7 - Construction Stormwater Pollution Prevention](#) is recommended for the development of these Construction SWPPPs. A checklist is contained in [Chapter 7 - Construction Stormwater Pollution Prevention](#) that may be helpful in preparing and reviewing the Construction SWPPP.

On construction sites that infiltrate all stormwater runoff, the primary consideration in the preparation of the Construction SWPPP is the protection of the infiltration BMPs from fine sediments during the construction phase and protection of ground water from other pollutants. Several of the other elements are very important at these sites as well, such as marking the clearing limits, establishing the construction access, and managing the project.

Under current federal regulations, if a project disturbs > 1 acre and discharges to receiving water, the local jurisdiction may require review and approval of the Construction SWPPP prior to construction.

### ***Small-Project Construction Stormwater Pollution Prevention***

This guidance is recommended for small construction projects adding or replacing < 2,000 square feet (sf) of impervious surface or clearing < 7,000 sf to prevent the discharge of sediment and other pollutants to the maximum extent practicable. The following should be evaluated for small construction projects:

- Plan and implement proper clearing and grading of the site. It is most important only to clear the areas needed, thus keeping exposed areas to a minimum. Phase clearing so that only those areas that are actively being worked are uncovered. Note: Clearing limits should be flagged in the lot or area prior to initiating clearing.
- Soil should be managed in a manner that does not permanently compact or deteriorate the final soil and landscape system. If disturbance and/or compaction occur the impact must be corrected at the end of the construction activity. This should include restoration of soil depth, soil quality, permeability, and percentage of organic matter. Construction practices must not cause damage to or compromise the design of permanent landscape or infiltration areas.
- Locate excavated soil a reasonable distance behind the curb, such as in the backyard or side yard area. This will increase the distance eroded soil must travel to reach the drainage system. Soil piles should be covered until the soil is either used or removed. Piles should be situated so that sediment does not run into the street or adjoining yards.
- Backfill foundation walls as soon as possible and rough grade the lot. This will eliminate large soil mounds, which are highly erodible, and prepares the lot for temporary cover, which will further reduce erosion potential.

- Remove excess soil from the site as soon as possible after backfilling. This will eliminate any sediment loss from surplus fill.
- If a lot has a soil bank higher than the curb, a trench or berm should be installed moving the bank several feet behind the curb. This will reduce the occurrence of gully and rill erosion, while providing a storage and settling area for stormwater.
- The construction entrance should be stabilized where traffic will be leaving the construction site and traveling on paved roads or other paved areas within 1,000 feet of the site.
- Provide for periodic street cleaning to remove any sediment that may have been tracked out. Sediment should be removed by shoveling or sweeping and carefully removed to a suitable disposal area where it will not be eroded again.
- Utility trenches that run up and down slopes should be backfilled within 7 days. Cross-slope trenches may remain open throughout construction to provide runoff interception and sediment trapping, provided that they do not convey turbid runoff off-site.

### 3.2.8 Step 7: Complete the Stormwater Site Plan

The SSP encompasses the entire submittal to the local jurisdiction with drainage review authority. The SSP should address the following:

- **Project overview:** The project overview must provide a general description of the project, predeveloped and developed conditions of the site, site area and size of the improvements, and the pre- and postdevelopment stormwater runoff conditions. The overview should summarize difficult site parameters, the natural drainage system, and drainage to and from adjacent properties, including bypass flows.
- **Vicinity map:** This map should clearly locate the property, identify all roads bordering the site, show the route of stormwater off-site to the local natural receiving water, and show significant geographic features and sensitive/critical areas (streams, wetlands, lakes, steep slopes, etc.).
- **Site map:** This map should use at a minimum a U.S. Geological Survey 1:2,400-scale topographic map as a base and display the following:
  - Acreage and outlines of all drainage basins
  - Existing stormwater drainage to and from the site
  - Routes of existing, construction, and future flows at all discharge points
  - The length of travel from the farthest upstream end of a proposed drainage system to any proposed flow control and runoff treatment BMP
- **Soils map:** This map should show the soils within the project site as verified by field testing. It is the designer's responsibility to ensure that the soil types of the site are properly identified and correctly used in the hydrologic analysis.
- **Existing conditions summary:** This is the summary described in Step 1. If the local jurisdiction does not require a detailed off-site analysis, this summary should also describe the

following:

- The natural receiving waters that the stormwater runoff either directly or eventually (after flowing through the downstream conveyance system) discharges to
- Any area-specific requirements established in local plans, ordinances, or regulations or in water cleanup plans approved by the Washington State Department of Ecology
- **Off-site analysis report:** This is the report described in Step 3.
- **Permanent stormwater control plan:** This is the plan described in Step 5.
- **Construction SWPPP:** This is the plan described in Step 6.
- **Special reports and studies:** Include any special reports and studies conducted to prepare the SSP (e.g., a soils report that could include the results of soil sampling and testing, infiltration tests and/or soil gradation analyses, depth to ground water; wetlands delineation).
- **Other permits:** List conditions from other permits and regulatory agency approvals that affect the drainage plan or contain more restrictive drainage-related requirements.
- **Operation and maintenance (O&M) manual:** Submit an O&M manual for each flow control and runoff treatment BMP based on the guidelines included in [2.7.8 Core Element #7: Operation and Maintenance](#).
- **Declaration of covenant for privately maintained flow control and treatment BMPs:** A declaration of covenant and grant of easement may be required by the local jurisdiction for privately maintained flow control and runoff treatment BMPs to ensure future maintenance and allow access for inspection by the local jurisdiction.
- **Bond quantities worksheet:** If the local jurisdiction adopts a requirement for a performance bond (or other financial guarantee) for proper construction and operation of construction site BMPs, and proper construction of permanent drainage BMPs, the designer shall provide documentation to establish the appropriate bond amount.

### **3.2.9 Step 8: Check Compliance With All Applicable Core Elements**

The SSP as designed and implemented should specifically fulfill all Core Elements applicable to the project. Review the completed SSP to check that these requirements are satisfied.

## **3.3 Plans Required After Stormwater Site Plan Approval**

### **3.3.1 Introduction**

This section includes the specifications and contents required of those plans submitted after the local jurisdiction has approved the original Stormwater Site Plan (SSP).

### **3.3.2 Stormwater Site Plan Changes**

If the designer wishes to make changes or revisions to the originally approved SSP, the proposed revisions should be submitted to the local jurisdiction or agency with review authority prior to construction. The submittals should include the following:

- Substitute pages of the originally approved SSP that include the proposed changes
- Revised drawings showing structural changes
- Other supporting information that explains and supports the reason for the change

### **3.3.3 Record Drawings**

If the project included construction of conveyance systems, runoff treatment Best Management Practices (BMPs), flow control BMPs, or structural source control BMPs, the applicant should submit record drawings to the local jurisdiction when the project is completed. These should be engineering drawings that accurately represent the stormwater infrastructure of the project as constructed. These corrected drawings must be professionally drafted revisions that are stamped, signed, and dated by a licensed engineer in the state of Washington.

*This page has been intentionally left blank for double-sided printing.*

## Appendix 3-A: Off-Site Analysis

### Objective

To identify and evaluate potential off-site water quality, erosion, slope stability, and drainage impacts that may be caused or aggravated by a proposed project, and to determine measures for preventing impacts and for not aggravating existing impacts. Aggravated shall mean increasing the frequency of occurrence and/or severity of a problem.

### Guidelines

Some of the most common and destructive impacts of land development are erosion of downgradient properties, localized flooding, and slope failures. These are caused by increased stormwater runoff volumes or concentrated flows, increased volumes of stormwater injected into the subsurface, increase in velocity, and/or changed runoff patterns (e.g., type and location of discharge). However, taking the precautions of off-site analysis could prevent substantial property damage and public safety risks.

The existing or potential impacts to be evaluated and mitigated shall include the following:

- Conveyance system capacity problems
- Localized flooding
- Upland erosion impacts, including landslide hazards
- Downstream impacts to protective designations, including special resource waters, sole source aquifers, and recharge areas
- Stream channel erosion at the outfall location
- Violations of surface water quality standards as identified in a basin plan or a Total Maximum Daily Load (water cleanup plan); or violations of ground water standards in a wellhead protection area

Projects are required to initially submit, with the permit application, a qualitative analysis of each downstream system leaving the site. The analysis should accomplish four tasks.

#### **Task 1: Define and Map the Study Area**

Submission of a site map showing site property lines; a topographic map (at a minimum a U.S. Geological Survey 1:24,000-scale quadrangle topographic map) showing site boundaries, study area boundaries, proposed area of disturbance, downstream flow path, and potential/existing problems.

#### **Task 2: Review All Available Information on the Study Area**

This should include all available basin plans, ground water management area plans, geotechnical reports, drainage studies, floodplain/floodway Federal Emergency Management Agency (FEMA) maps, wetlands inventory maps, critical areas maps, stream habitat reports, salmon distribution

reports, etc. Contact the local jurisdiction for assistance in locating these and other relevant or historical data.

### **Task 3: Field Inspect the Study Area**

The designer must physically inspect the existing on- and off-site drainage systems of the study area for existing or potential problems and drainage features. As part of an initial inspection and investigation, the designer should take the following actions:

- Investigate problems reported or observed during the resource review.
- Locate existing/potential constrictions or capacity deficiencies in the drainage system.
- Identify existing/potential flooding problems.
- Identify existing/potential overtopping, scouring, bank sloughing, or sedimentation.
- Identify significant destruction of aquatic habitat (e.g., siltation, stream incision).
- Collect qualitative data on features such as land use, impervious surface, topography, geological hazards, soils, presence of streams, wetlands.
- Collect information on pipe sizes, channel characteristics, drainage structures.
- Verify tributary contributing areas identified in [Task 1: Define and Map the Study Area](#).
- Contact the local jurisdiction with drainage review authority, neighboring property owners, and residents about drainage problems.
- Note date and weather at time of inspection.

### **Task 4: Describe the Drainage System and Its Existing and Predicted Problems**

For each drainage system component (e.g., pipe, culvert, bridges, outfalls, ponds, vaults) the following should be covered in the analysis: location, physical description, problems, and field observations.

All existing or potential problems (e.g., ponding water, erosion, hydrologic contributions from off-site areas) identified in [Task 2: Review All Available Information on the Study Area](#) and [Task 3: Field Inspect the Study Area](#) should be described. The descriptions should be used to determine whether adequate mitigation can be identified, or whether more detailed quantitative analysis is necessary. The following information should be provided for each existing or potential problem:

- Magnitude of or damage caused by the problem
- General frequency and duration
- Return frequency of storm or flow when the problem occurs (may require quantitative analysis)
- Water elevation when the problem occurs
- Names and concerns of parties involved



- Current mitigation of the problem
- Possible cause of the problem
- Whether the project is likely to aggravate the problem or create a new one

Upon review of this analysis, the local jurisdiction may require mitigation measures to address the problems, or a quantitative analysis, depending on the presence of existing or predicted flooding, erosion, or water quality problems, and on the proposed design of the on-site drainage BMPs. The analysis should repeat [Task 3: Field Inspect the Study Area](#) and [Task 4: Describe the Drainage System and Its Existing and Predicted Problems](#), using quantitative field data including profiles and cross sections.

The quantitative analysis should provide information on the severity and frequency of an existing problem or the likelihood of creating a new problem. It should evaluate proposed mitigation intended to avoid aggravation of the existing problem and to avoid creation of a new problem.

*This page has been intentionally left blank for double-sided printing.*

## **Appendix 3-B: Basin Maps**

### ***Site Planning — Basin Maps Checklist***

The following items should be included on predeveloped and postdeveloped basin maps:

- Site boundary
- Basin limits, both on-site and off-site areas which contribute or receive stormwater runoff onto or from the project, field verified by a licensed engineer in the state of Washington
- Drainage subbasins. All subbasins should be clearly labeled and correlated with the calculations.
- Topographic contours, which should extend beyond the project or drainage basin boundaries to the extent necessary to confirm basin limits used in the calculations; or, in the absence of topographic mapping being available, a licensed engineer in the state of Washington may field verify the basin limits, including contributing off-site areas, and should describe how the basin limits were determined.
- Significant drainage features, natural or man-made, such as creeks, seasonal drainage channels, culverts, closed depressions, maintenance holes
- Time of concentration routes, clearly labeled and correlated with the calculations
- Footprint of proposed drainage features, such as ponds, vegetated or other infiltration Best Management Practices (BMPs), pipe routes, ditches
- Indications of floodplain limits, as defined by Federal Emergency Management Agency (FEMA) or other studies
- North arrow and scale bar
- Wetlands
- Existing easements

*This page has been intentionally left blank for double-sided printing.*

## **Appendix 3-C: Stormwater Construction Plans**

### ***Site Planning — Stormwater Construction Plans Checklist***

The following items should be included on stormwater construction plans, as applicable:

- A plan profile of all key drainage systems including: streets, roads, and drainage Best Management Practices (BMPs).
- Elevation datum
- North arrow and scale bar
- Right-of-way details
- Outfall details
- Ditch details
- Invert elevations, slopes, and lengths of ditches
- Cross sections of all open ditches
- Elevations of all inlet grates
- Size, types, invert elevations, and lengths of all culverts and pipe systems
- Invert elevations of the existing or other proposed drainage system to which the drainage plan proposes to connect
- Stationing of all inlets, culverts and pipe systems angle points
- Invert elevations of pipes at all structures such as catch basins or maintenance holes
- Construction details for inlets, drywells, detention BMPs, etc. (notes referring to standard plans may suffice where applicable)
- Drainage easements shown, with key dimensions for depicting location, width, and length
- The location of existing underground and aboveground utilities
- Lot grading elevations where appropriate
- Grading plan for detention ponds. The grading plan should include:
  - existing contours
  - proposed contours
  - catch points

A typical cross section of the pond should be provided in the plans, showing:

- bottom of pond elevation
  - maximum water surface elevation for the design storm(s)
  - inlet and outlet elevations
  - berm elevation and slopes
  - keyway location and dimensions
- Detention ponds, pipe inlets and outlets, ditches, and drainage structures, which are serving public roads or are in single-family residential neighborhoods, should be horizontally defined with respect to property corners, street stationing, or a coordinate system.
  - Drainage ditches should have their longitudinal grades defined with either a profile or elevation grades at intervals of 50 feet. Ditch centerlines and flow directions should be also be illustrated.
  - Summary of short- and long-term operation and maintenance requirements

# **Appendix 3-D: Additional Guidance on Low Impact Development Site Planning Principles and Design Strategies**

## **3.D.1 Introduction**

This appendix includes additional guidance on low impact development (LID) site planning principles and design strategies that have been integrated with minor revisions from Chapters 2 and 3 of the *Eastern Washington Low Impact Development Guidance Manual*.

## **3.D.2 LID Site Planning**

### ***Introduction***

Performing a comprehensive inventory and analysis is an essential first step preceding low impact development (LID) design. The inventory and analysis should include on- and off-site natural and built conditions that would affect the project design. Policies, land use controls, and legally enforceable restrictions should also be evaluated and documented.

The process of planning for LID includes an in-depth analysis of the natural conditions of the site (e.g., soils, topography, hydrology, etc.), as well as the built and regulatory elements (e.g., access, utilities, easements, zoning, etc.) that will influence development and the use of LID practices. This appendix provides an overview of LID planning principles and presents guidelines for performing a site analysis and developing a composite site map that can be used as the basis for LID site design.

### ***LID Planning Principles***

The following key principles of LID planning provide a foundation for LID site design, construction, and long-term maintenance:

- Preserving native vegetation
- Protecting critical areas
- Minimizing impervious surfaces
- Minimizing grading and compaction of site soils
- Preserving existing flow paths
- Infiltrating stormwater runoff
- Dispersing stormwater to vegetated Best Management Practices (BMPs)
- Utilizing naturalistic surface conveyance BMPs
- Utilizing small-scale, distributed LID BMPs

These principles should be evaluated at the beginning of the project and should be revisited during design iterations to provide for a comprehensive approach to LID site planning and design. Design of

LID BMPs as described in [Chapter 5 - Runoff Treatment BMP Design](#) and [Chapter 6 - Flow Control BMP Design](#) should integrate with and not replace application of these key principles.

### **Site Analysis**

Site analysis is the evaluation and documentation of natural and built elements on the site, culminating in development of a compost site map that can be used as the basis for LID site design. The scope of the site analysis may vary with the type and size of the project, individual site characteristics, and requirements of the local jurisdiction.

The remainder of this section provides details related to site analysis and documentation of the following project site elements:

- Topography
- Hydrologic patterns and features
- Soil and subsurface hydrologic characterization
- Native vegetation and soil protection areas
- Wetlands
- Riparian management areas
- Streams
- Floodplains
- Access
- Utilities
- Land use controls

### **Topography**

Understanding the existing site topography is important to implementing LID principles, such as minimizing grading and preserving existing flow paths, as well as planning for siting LID BMPs on-site. Relatively large projects may require a topographic survey prepared by a registered land surveyor, with the following recommended contour resolutions based on site slope:

- Up to 10% slopes, 2-foot contours
- Over 10% to < 20% slopes, 5-foot contours
- 20% or greater slopes, 10-foot contours

### **Hydrologic Patterns and Features**

Understanding and preserving existing hydrologic patterns and features is paramount to achieving many of the key LID planning principles, and begins by identifying and maintaining on-site hydrologic



processes, patterns and the physical features (streams, wetlands, native soils and vegetation, etc.) that influence those patterns.

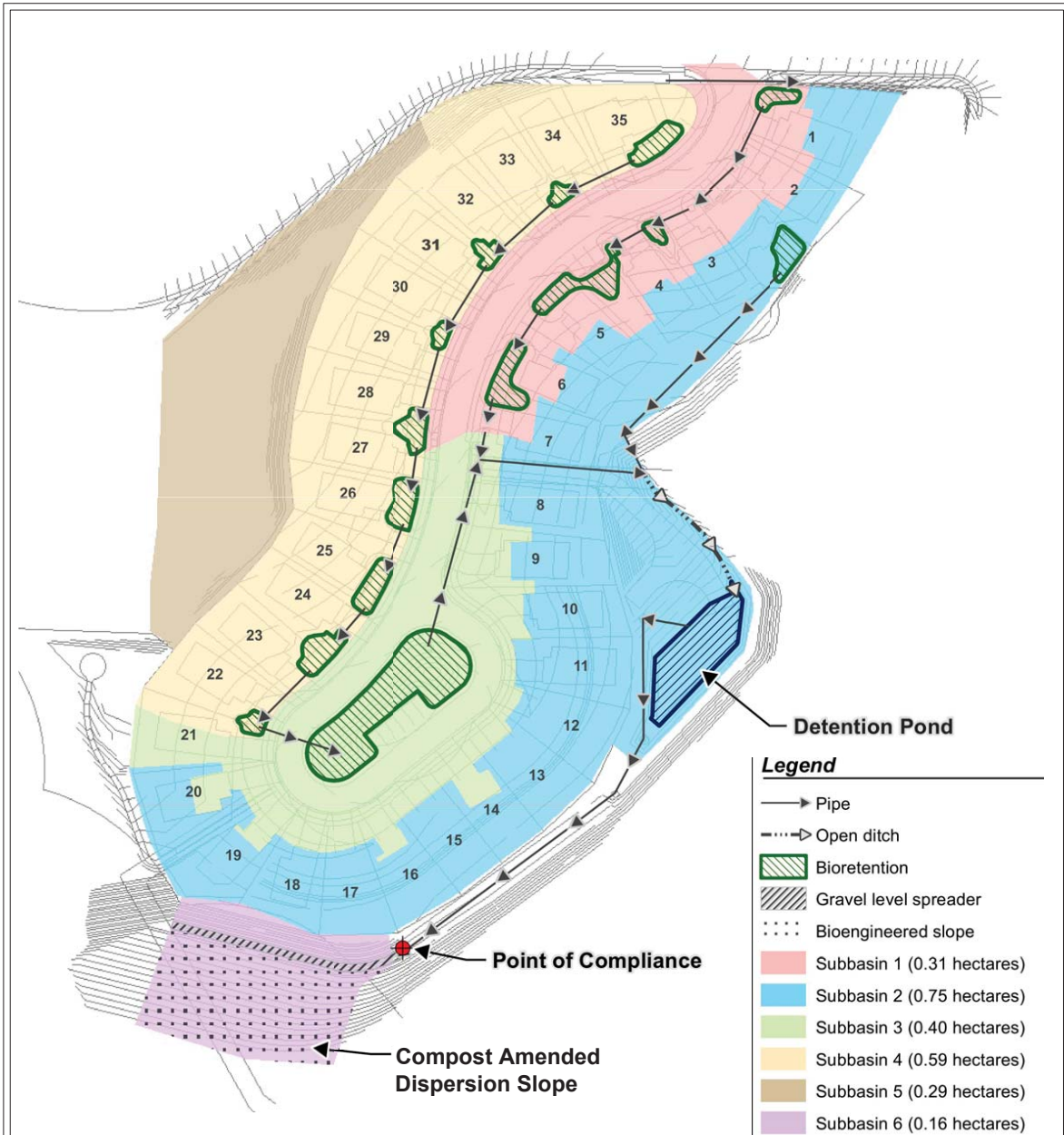
The documentation of hydrologic patterns and features will require locating and mapping prominent hydrologic features but should also include the following actions:

- Identifying and mapping minor hydrologic features including seeps, springs, closed depression areas, and drainage swales
- Identifying and mapping surface flow patterns during wet periods, and identify signs of duration and energy of storm flows including vegetation composition, and erosion and deposition patterns

It may be necessary to divide the site into subbasins in order to preserve existing flow paths and properly locate and size small-scale, distributed LID BMPs, as are key LID planning principles, it may be necessary to divide the site into subbasins (see [Figure 3.1: Subbasin Delineation for Designing Distributed LID Practices](#)). This detailed approach provides several advantages:

- Individual practices receive smaller hydraulic and pollutant loads.
- Small-scale practices can be arranged in the project efficiently and save space for other amenities.
- Individual LID BMPs can be accurately sized based on the appropriate tributary contributing areas and their cumulative performance across the site can be evaluated.

**Figure 3.1: Subbasin Delineation for Designing Distributed LID Practices**



Source: Low Impact Development Technical Guidance Manual for Puget Sound (WSU-PSP, 2012)



## Subbasin Delineation for Designing Distributed LID Practices

Revised June 2013

Please see <http://www.ecy.wa.gov/copyright.html> for copyright notice including permissions, limitation of liability, and disclaimer.

The following text provides additional discussion of the planning practices associated with protecting wetlands, streams, riparian areas, and floodplains. Mapping and planning for each of these types of hydrologic features should be conducted at the subbasin scale. Check with your local jurisdiction for related ordinances and planning documents.

### **Wetlands**

On- and off-site wetlands should be delineated and assessed in accordance with local critical areas regulations. Delineating the wetland to determine its edge is accomplished by using the U.S. Army Corps of Engineers' *Wetland Delineation Manual* ([USACE, 1987](#)).

After determining the limits or edge of the wetland, it must be rated or assessed. The rating or assessment of the wetland is performed so that appropriate protective mechanisms, typically buffers, can be applied. The *Washington State Wetland Rating System for Eastern Washington* ([Ecology, 2014](#)) is the resource used to rate the ecological and hydrological value of the wetland. Buffer standards are typically found in locally adopted critical areas regulations.

Core assessment and management objectives for a project located in a drainage basin with a wetland designated as high quality and sensitive and not used as flow control or treatment should include the following:

- Protect native riparian vegetation and soils.
- Protect diverse native wetland habitat characteristics to support the native assemblage of wetland biota.
- Match the preproject surface and ground water inputs that drive wetland water surface elevations.

The following steps should be used as a starting point to adequately inventory and provide an assessment of wetlands, where applicable:

- Delineate and assess the wetland category using the *Wetland Delineation Manual* ([USACE, 1987](#)) and the *Washington State Wetland Rating System for Eastern Washington* ([Ecology, 2014](#)). Protective buffers will be found in the critical areas regulations for the local jurisdiction.
- Determine if the wetland meets the criteria for "Hydrologic Modification of a Wetland" in [2.7.7 Core Element #6: Flow Control](#).

### **Streams**

Determining appropriate assessment and management protocols for stream channel corridors will be found in locally adopted critical areas regulations. If the project is within a watershed with streams designated as high quality and sensitive, objectives for assessment and management strategies should include the following:

- Protect mature native riparian vegetation and soils.
- Protect diverse native stream habitat characteristics to support the native assemblage of stream life.
- Maintain predevelopment hydrology.

The following steps should be used to adequately inventory and analyze creeks, streams, or rivers, where applicable:

- Identify stream category by using the Washington State Department of Natural Resources water typing classification system ([WAC 222-16-030](#)).
- Identify riparian area and fish and wildlife habitat in locally adopted critical areas regulations. See the Riparian Areas subsection for additional discussion of riparian areas.
- Assess general stream corridor condition and determine if there is a need for more detailed assessment and specific management strategies. Specific management strategies, typically including the application of protective buffers, are found in locally adopted critical areas regulations.

### ***Riparian Areas***

Riparian areas are those areas adjacent to streams, lakes, and ponds that support native vegetation adapted to saturated or moderately saturated soil conditions. Riparian areas with adequate mature vegetation, land form, and large woody debris can:

- Dissipate stream energy and erosion associated with high-flow events;
- Filter sediment, capture bedload, and aid in floodplain development;
- Improve floodwater retention and ground water recharge;
- Develop diverse ponding and channel characteristics that provide habitat necessary for fish and other aquatic life to spawn, feed and find refuge from flood events;
- Provide vegetation litter and nutrients to the aquatic food web;
- Provide habitat for a high diversity of terrestrial and aquatic biota;
- Provide shade and temperature regulation; and
- Provide adequate soil structure, vegetation and surface roughness to slow and infiltrate stormwater delivered as precipitation or low-velocity sheet flow from adjacent areas ([Prichard et al., 1998](#))

The objective for riparian area assessment and management is to protect, maintain and restore mature native vegetation cover that provides the functions and structures listed in this section. Consult the critical areas regulations for the local jurisdiction for inventory, assessment, and management standards. Also consult the local regulations to determine whether or not construction of LID BMPs would be allowed in riparian area buffers.

### ***Floodplains***

The objective for floodplain area assessment and management is to maintain or restore the following:

- Connection between the stream channel, floodplain and off channel habitat
- Mature native vegetation cover and soils

- Predevelopment hydrology that supports the above functions, structures, and flood storage

The following steps should be used to inventory and assess floodplain areas, where applicable:

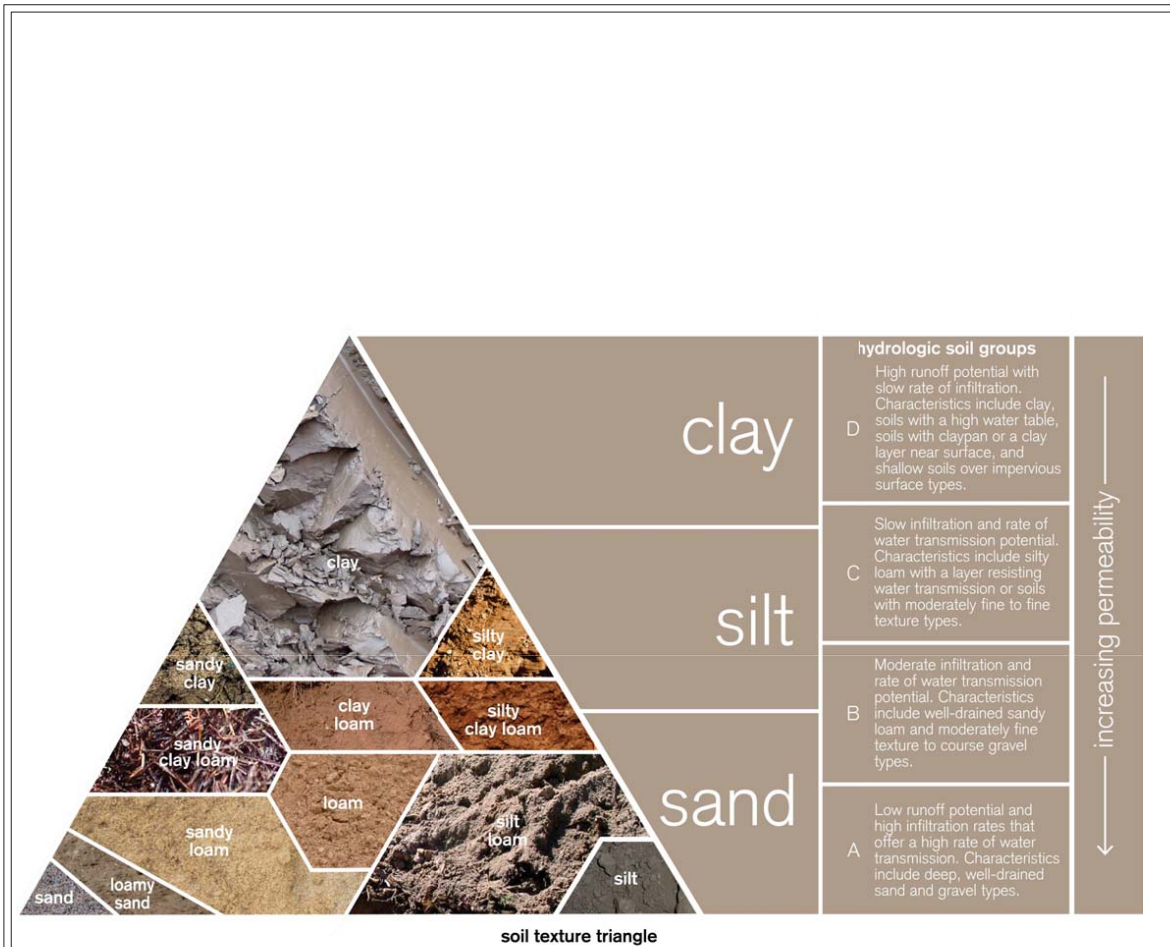
- Identify, survey, and map the 100-year floodplain and channel migration zone.
- Inventory, survey, and map the composition and structure of vegetation within the floodplain area.
- Identify, survey, and map the active channel.

Where possible, development within the 100-year floodplain should be avoided to best protect people and property and help maintain critical floodplain functions, such as storage and conveyance of floodwaters.

### **Soil and Subsurface Hydrology Characterization**

In-depth characterization of soil and subsurface hydrology is vital to LID planning and design. Typically, the goals of this task are to evaluate the site's feasibility for infiltration and, where appropriate, determine long-term native soil design infiltration rates. Soil characterization is also important to help specify materials to be used in design. For example, geotextile layers for separation may not be needed on the sides or bottom of excavations for bioretention or permeable pavement if the native site soils are not expected to migrate into the various BMP layers based on grain size distributions (see [Figure 3.2: Soil Texture Triangle](#)).

**Figure 3.2: Soil Texture Triangle**



Source: Low Impact Development: A Design Manual for Urban Areas (University of Arkansas Community Design Center, 2010)



## Soil Texture Triangle

Revised June 2013

Please see <http://www.ecy.wa.gov/copyright.html> for copyright notice including permissions, limitation of liability, and disclaimer.

This section documents well-accepted practices that may be used to characterize the soils and subsurface hydrologic conditions and evaluate long-term native soil infiltration rates to be used for design of infiltration-based BMPs. Designers should consult local jurisdiction requirements to determine the soil and subsurface hydrology characterization method that will be required to support the design.

Soil and subsurface characterization relies to a large extent on infiltration test pits, soil test pits, or soil borings. The type and number of these tests for initial site assessment is variable and site specific; however, some general guidelines are appropriate. A few strategically placed tests are generally adequate for initial soil and infiltration assessment. Test locations are determined by topography, estimated soil type, hydrologic characteristics, and other site features. Consult a certified soil scientist, engineer, geologist, hydrogeologist or engineering geologist licensed in the state of Washington for the infiltration test pit, soil test pit, and soil boring recommendations for initial assessment. A more detailed soil and infiltration capacity assessment may be necessary after the preliminary site layout with location of LID stormwater controls is established.

The methods described in this section are used to determine the measured saturated hydraulic conductivity rate for existing subgrade soils for overall site assessment and beneath bioretention areas and permeable pavement. The measured saturated hydraulic conductivity with no correction factor may be used as the design infiltration rate if the licensed professional deems the infiltration testing described in this section (and perhaps additional tests) are conducted in locations and at appropriate distribution capable of producing a soil profile characterization that fully represents the infiltration capability where the bioretention or permeable pavement areas are located (e.g., if the small-scale pilot infiltration tests (PITs) are performed for all bioretention areas and the site soils are adequately homogeneous).

If deemed necessary by a licensed professional, a correction factor may be applied to the measured saturated hydraulic conductivity to determine the long-term design native soil infiltration rate. Whether or not a correction factor is applied and the specific number used will depend on heterogeneity of the site soils and number of infiltration tests in relation to the number and type of infiltration areas. For bioretention, the overlying bioretention soil media provides excellent protection for the underlying native soil from sedimentation; accordingly, the measured native soil infiltration rate for bioretention does not require a correction factor for influent control and potential clogging over time.

For recommendations on test frequency and correction factors specific to bioretention, see [5.4 Surface Infiltration and Bioinfiltration BMPs](#). For recommendations on test frequency and correction factors specific to permeable pavement, see [6.3 Infiltration BMPs](#).

The depth and number of test holes or test pits and samples should be increased if, in the judgment of a licensed professional, conditions are highly variable and such increases are necessary to accurately estimate the performance of the infiltration system. Licensed professionals for this type of evaluation include certified soil scientists, licensed engineers in the state of Washington, geologists, hydrogeologists or licensed engineering geologists in the state of Washington. The exploration program may also be decreased if, in the opinion of the licensed professional, the conditions are relatively uniform and omitting the test pits or borings will not influence the design or successful operation of the BMP. At sites with a high water table, the subsurface exploration sampling need not be conducted deeper than 2 feet below the ground water table.

Prepare detailed logs for each test pit or test hole and a map showing the location of the test pits or test holes. Logs should include, at a minimum: depth of pit or hole, soil descriptions, depth to water, and presence of stratification. Logs should substantiate whether stratification does or does not exist. The certified soils professional may consider additional methods of analysis to substantiate the presence of stratification that may influence the design or successful operation of the LID practice.

Soil stratigraphy should also be assessed for low-permeability layers, highly permeable sand/gravel layers, depth to ground water, and other soil structure variability necessary to assess subsurface flow patterns. Soil characterization for each soil unit (soil strata with the same texture, color, density, compaction, consolidation, and permeability) should include the following:

- Grain size distribution
- Textural class
- Percentage of clay content
- Cation exchange capacity
- Color/mottling
- Variations and nature of stratification

If the ground water in the area is known to be < 5 feet below the proposed LID BMP, the ground water regime should be assessed. At a minimum, ground water monitoring wells should be installed to determine ground water depth and seasonal variations, considering both confined and unconfined aquifers. Monitoring through at least one high ground water period is necessary, unless site historical data regarding ground water levels are available.

If on-site infiltration may result in shallow lateral flow (interflow), the conveyance and possible locations where that interflow may reemerge should be assessed by a certified soil scientist, licensed engineer in the state of Washington, geologist, hydrogeologist or licensed engineering geologist in the state of Washington (or suitably trained persons working under the supervision of the above professionals or by a locally licensed on-site sewage designer). In general, a minimum of three wells associated with three hydraulically connected surface or ground water features are necessary to determine the direction of flow and gradient. Alternative means of establishing the ground water levels may be considered. If the ground water in the area is known to be > 5 feet below the proposed LID BMP, detailed investigation of the ground water regime is not necessary.

Special considerations are necessary for highly permeable gravel areas. Signs of high ground water will likely not be present in gravel lacking finer grain material such as sand and silt. Test pit and monitoring wells may not show high ground water levels during low precipitation years. Accordingly, sound professional judgment, considering these factors and water quality treatment needs, is required to design multiple and dispersed infiltration BMPs on sites with gravel deposits.

A ground water mounding analysis should be considered if the minimum depth to bedrock, water table, or other impermeable layer is < 5 feet. Ground water mounding analysis may also warrant consideration if the contributing area drains to a LID BMP is large relative to the BMP footprint area.



See [Appendix 6-B: Guidelines for Site Characterization of Geotechnical Properties](#), [6.B.3 Recommended Field Test Procedures](#), and [6.B.4 Recommended Laboratory Test Procedures](#) for detailed discussion of the following methods for evaluating native soil infiltration rates:

- In situ small-scale PIT method
- In situ large-scale PIT method
- Soil grain size analysis method

Generally, the small-scale and large-scale PITs are similar; however, the small-scale PIT reduces cost and test time and is appropriate for LID BMPs that have relatively low hydraulic loadings. The large-scale PIT is preferred for large-scale permeable pavement installations where stormwater from adjacent impervious surfaces is directed to the pavement surface, resulting in higher hydraulic loads. The soil grain size analysis method can be used if the site has soils unconsolidated by glacial advance. Consult local jurisdiction for soil testing and reporting requirements that pertain to the project site.

### **Native Vegetation and Soil Protection Areas**

The conservation and use of on-site native vegetation and soil for stormwater management is a central tenet of LID design. Protecting these features helps reduce runoff, increase evapotranspiration, and reduce erosion from the site.

Vegetation surveys may be needed to determine baseline conditions, establish long-term management strategies, and determine appropriate application of dispersion techniques if stormwater is directed to the protection area. The following are steps to conduct a basic inventory and assessment of the function and value of on-site native vegetation:

- Identify vegetated areas on the site, including species and condition of ground cover and shrub layer.
- Identify underlying soils using soil pits and soil grain analysis to assess infiltration capability ([6.3 Infiltration BMPs](#) for site-specific analysis procedures).

### **Access**

Vehicle and pedestrian access, circulation, and parking are elements of the built environment that should be identified as part of the site inventory and analysis. Access can often represent a controlling element for the design of a site. The designer should consult local requirements for site access. These requirements will establish the number of allowed access points, the width of the access, the spacing of access points between sites on the same or opposite side of the adjacent street right-of-way, and pedestrian circulation requirements along and through the site to the proposed use.

The following steps should be used to inventory and assess access:

- Map the location of roads, driveways, and other points of ingress and egress within 50 feet of the site.
- Consult the local jurisdiction to identify the classification of the street that will be providing

access to the site. Knowing the classification of the abutting street will allow the designer to understand frontage improvements, sight distance requirements, allowed driveway widths, and other geometric design requirements.

- Consult with the local jurisdiction to understand any motorized or nonmotorized plans that may influence the design of the project.

### **Land Use Controls**

It is important to consult the local jurisdiction's planning department and review land use regulations in order to determine the allowable land uses and development standards. Review of the local planning standards will reveal if there are limitations on impervious surface coverage (lot coverage), minimum landscaping requirements, minimum lot area, setback requirements, parking requirements, and site design standards associated with building placement and orientation.

The following steps should be used to analyze and document land use controls:

- Review applicable comprehensive plan designation, zoning classifications, and overlay districts that may apply to the site. Overlay districts may include requirements for special design review or historic district overlays.
- Determine whether a locally adopted Shoreline Master Program applies to the site and comply with applicable guidelines and requirements.
- Consult with the local jurisdiction to identify other land use regulations that may allow clustering or other practices intended to minimize impervious surfaces. Examples include planned use district chapters and performance zoning chapters.

### **Utility Availability and Contacts**

The location of wet (e.g., water, sewer, stormwater, etc.) and dry (e.g., power, phone, cable, etc.) utilities must be identified and the adequacy or concurrency of these utilities should be confirmed. Where utilities already exist on the site, easements or other covenants that may stipulate on-site restrictions should be identified and mapped by a surveyor. The county auditor or recorder's office or a title company is often a good source of finding restrictions and easements that may be recorded against the title of the property. Also consider directly contacting the utility purveyors for this information.

If new utilities need to be extended to the site, the designer will need to understand where the utility will come from, and potentially extend to, and the impact that easements and restrictions may have on the site design.

The following steps should be used to assess utilities:

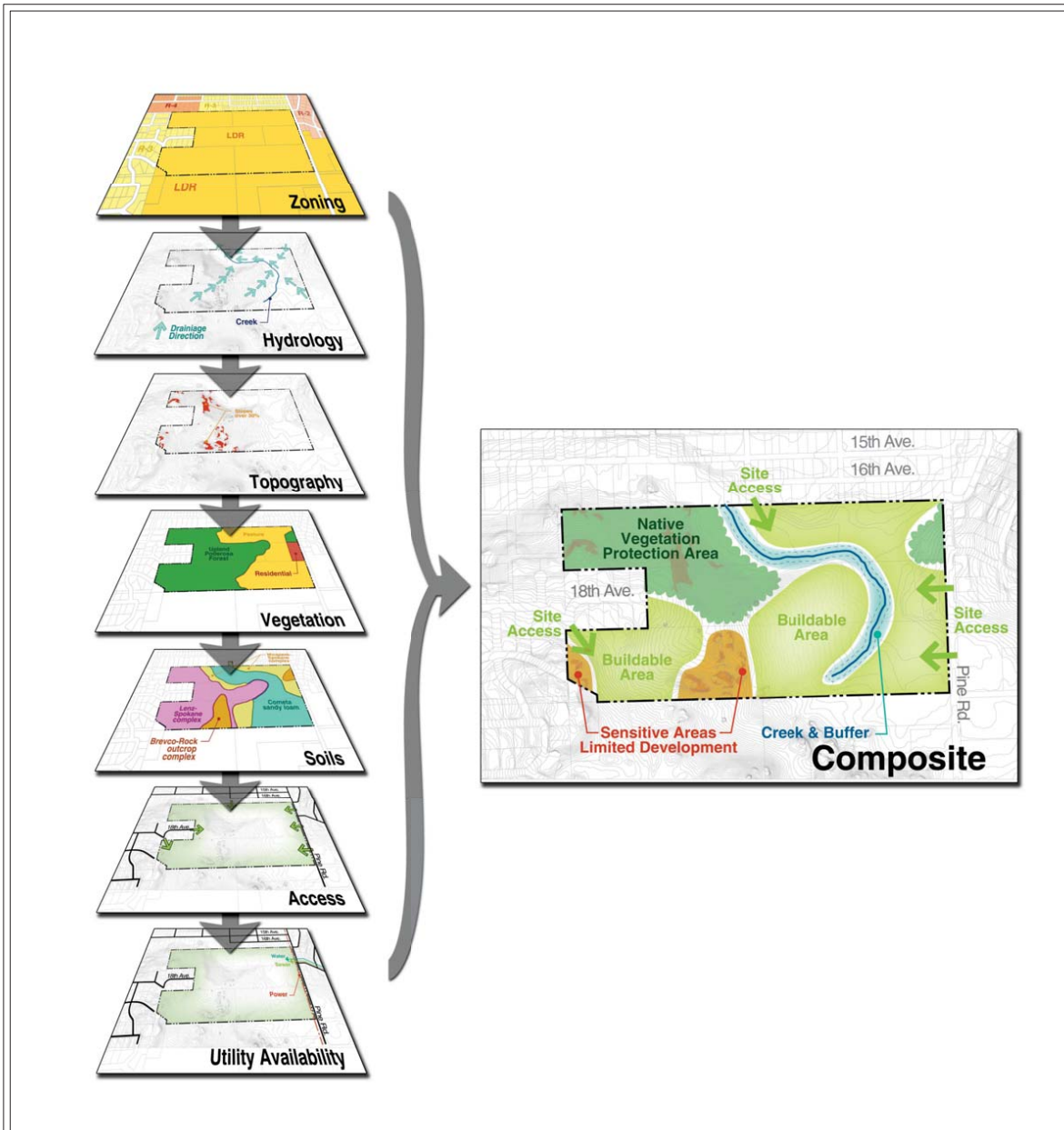
- Consult with the utility purveyor(s) to determine the location of wet (e.g., water, sewer, stormwater, etc.) and dry (e.g., power, phone, cable, etc.) utilities and discuss the proposed plans. This consultation should be initiated during the planning phase of the project and extended through final design.
- Map existing utilities and utility easements on the site plan. Note the setbacks from the easements that may be required.

- Map existing utilities that may need to be moved and new utilities to be extended to the site.
- Design appropriate measures to move or protect utilities, as needed.

### ***Site Mapping Process***

Through the assessment process, discussed in the Site Analysis portion of this appendix, map layers are produced to delineate important site features. These map layers are combined to provide a composite site map that guides the layout of streets, structures, and other site features and the overall location of the development envelope(s) (see [Figure 3.3: Composite Site Map](#)). This composite site map should be used for all development types and will form the basis for the site design, discussed in detail in [3.D.3 Designing for LID](#).

**Figure 3.3: Composite Site Map**



Source: Low Impact Development Technical Guidance Manual for Puget Sound (WSU-PSP, 2012)



## Composite Site Map

Revised June 2013

Please see <http://www.ecy.wa.gov/copyright.html> for copyright notice including permissions, limitation of liability, and disclaimer.

## 3.D.3 Designing for LID

### *Design Process Overview*

The low impact development (LID) design process builds on the planning process and the resulting composite site map of LID opportunities and constraints ([3.D.2 LID Site Planning](#)). The topography, hydrology, soils, vegetation, and other natural site features that are identified and analyzed through the site analysis will guide the layout of roads, buildings, parking, and other physical infrastructure, as well as LID Best Management Practices (BMPs).

The following text provides an overview of the design process, including clearly defining site goals, identifying applicable design standards and requirements, developing solutions that match the project goals with site opportunities and constraints, preparing a preliminary layout, and finalizing the design. This general design process works for many types of design, including standard urban stormwater management practices and LID. Following the general design process overview, more detailed guidance is provided for design of infiltration-based LID BMPs.

### **Define Site Goals**

As described in [3.D.2 LID Site Planning](#), LID is versatile and may be successfully applied to meet a broad range of site goals. Possible site goals may include the following:

- Meeting core element requirements for runoff treatment and/or flow control
- Retrofitting existing developments for water quality improvement
- Reducing site water and energy demands
- Improving neighborhood aesthetics and mobility
- Controlling combined sewer overflows (CSOs)

The design process begins by clearly establishing the goals for the project, as these will ultimately drive the site layout and selection, sizing, and design of LID BMPs. LID projects commonly have multiple goals. By understanding all of the goals and their relative importance at the start of design, the team can develop plans that best accommodate all objectives or effectively prioritize what can be accomplished.

### **Identify Applicable Design Standards and Requirements**

The next step is identifying and reviewing the local jurisdiction's stormwater, roadway, utilities, and other engineering standards that will influence the design. This step typically involves meeting with local jurisdiction staff to discuss the proposed project and approach to meeting the standards and requirements. This meeting, often in the form of a preapplication meeting, should occur concurrent with the site inventory and assessment ([3.D.2 LID Site Planning](#)), and prior to the initiation of detailed site design. Local standards and requirements that may influence LID site design include the following:

- Stormwater regulations and design standards
- Setback requirements for infiltration BMPs

- Setback requirements for structures (e.g., cisterns may require setbacks from property lines)
- Soil and subsurface hydrology evaluation and reporting requirements
- Sizing methodologies to be used to demonstrate compliance with applicable stormwater requirements
- Street network design standards

During this review of design standards and requirements, the design team should also confirm local jurisdiction requirements for design submittal preparation, so the submittal requirements are understood prior to preparing the design package.

Every opportunity to optimize the LID design should be considered. Locally adopted design standards for street networks, generally derived by the American Association of State Highway and Transportation Officials (AASHTO), often require wider improvements than are necessary to facilitate the multimodal circulation objectives for the street classification. LID design practices, such as the use of flush curbs, can be used to satisfy International Fire Code (IFC) and AASHTO requirements for minimum travel widths. Municipal staff and project designers should review locally adopted standards for street improvements and parking requirements to consider design solutions where LID practices can maintain the use and function of the street network while concurrently achieving a stormwater benefit.

### **Selecting LID Solutions to Match Site Conditions and Goals**

The selection of the LID solutions that match site conditions and goals should equally consider nonstructural and structural practices. Factors that affect selection of LID solutions include the following:

- Ability to meet site goals (summarized in the Define Site Goals section of this appendix). For example, bioretention can help meet flow control and treatment stormwater requirements, improve transportation safety and mobility, and provide aesthetic neighborhood enhancement. Minimal excavation foundations can help maintain site hydrology and significantly improve constructability on challenging sites. Vegetated roofs can reduce impervious surface area and improve building insulation, reducing energy demands for the site. Understanding the site goals and priorities is key to selecting the best LID solutions to be included in the designs.
- Soils and subsurface hydrology ([3.D.2 LID Site Planning](#)), which dictate infiltration feasibility. Infiltration-based BMPs should be prioritized for meeting flow control and treatment requirements where feasible.
- Available space for siting BMPs.
- Constructability.
- Ease of maintenance.
- Public acceptance (for public projects).

Streets and parking lots contribute significant impervious surface coverage, so site strategies to minimize this cover should be considered before stormwater storage and runoff treatment options. The residential design strategies and commercial and industrial design strategies presented in the Residential Design Strategies and Commercial and Industrial Design Strategies subsections include analysis of opportunities to minimize impervious surface coverage through thoughtful design of streets, access, parking, and other site infrastructure.

### **Develop Preliminary Site Layout**

The preliminary site layout is an iterative process intended to balance and optimize the proposed project, avoid site constraints, conserve vegetation, and exploit infiltration opportunities. The site plan will show the location of proposed buildings, roadways, parking, utilities, and LID BMPs. The preliminary site layout should reflect required sizing of LID BMPs to meet applicable stormwater requirements, discussed in the Steps for Design of Infiltration BMPs subsection (see BMP sizing guidance in [Chapter 5 - Runoff Treatment BMP Design](#) and [Chapter 6 - Flow Control BMP Design](#)). The preliminary site layout should also be drawn to a scale to show the feasibility of locating BMPs in the available space, considering local setback and other applicable requirements.

During development of the preliminary site layout, strategies to minimize impervious cover should be explored. These may include reducing roadway widths and parking (as allowed by local ordinances), paving with permeable paving, clustering buildings, and reducing the land coverage of buildings by constructing taller and narrower footprints. All of these strategies make more land available for infiltration, open space, and landscape amenities. In addition, reducing impervious surfaces should result in smaller-sized stormwater BMPs, yielding significant savings in development and maintenance costs.

### **Finalize Designs**

After LID BMPs have been properly sized, the design team can begin preparing final site designs. This final design step entails updating the preliminary site plan (see previous section: [Develop Preliminary Site Layout](#)) to represent final sizing and BMP layout and confirming that the site goals are met. If the goals established for the project are not met, some iteration may be needed to reach the final design.

Review local engineering standards to determine the design package submittal requirements that pertain to each phase of design. A thorough understanding of the local engineering standards, submittal requirements, and review process will save significant time, money, and staff resources during design and permitting.

## ***Steps for Design of Infiltration BMPs***

This section provides a step-by-step process for designing infiltration-based LID BMPs, including bioretention and permeable pavement. The seven-step process is adapted from the *Stormwater Management Manual for Western Washington*, with updates as needed for eastern Washington.

### **Step 1. Select a Location**

Identifying a location for the infiltration-based BMP based on the ability to convey flow to the location and the expected soil conditions and locations based on preliminary soils and subsurface hydrology

evaluation ([3.D.2 LID Site Planning](#)). Conduct a preliminary check of local jurisdiction infiltration feasibility criteria and Site Suitability Criteria (SSC) in [6.3 Infiltration BMPs](#).

### **Step 2. Perform Preliminary BMP Sizing**

Estimate the geometry of the infiltration BMP using an approved modeling method listed in [Chapter 4 - Hydrologic Analysis and Design](#). For infiltration BMPs sized to meet treatment requirements, the BMP must successfully infiltrate the 6-month, 24-hour design storm. Flows in excess of this level can bypass the infiltration BMPs.

For infiltration BMPs sized to meet the flow control standard, the BMP must infiltrate a sufficient amount of the influent stormwater runoff such that any overflow/bypass meets the allowed peak flow discharge rate.

### **Step 3. Develop Trial Infiltration BMP Geometry**

Use the preliminary infiltration rate developed from the soils and subsurface hydrology evaluation ([3.D.2 LID Site Planning](#)) to develop the trial BMP geometry. If infiltration rates are not available during this step, use a default infiltration rate of 0.5 inches per hour. Use this trial BMP geometry to help locate the BMP and for planning purposes in developing the geotechnical subsurface investigation plan.

### **Step 4. Complete More Detailed Site Characterization Study and Consider Site Suitability Criteria**

Information gathered during initial soils and subsurface hydrology investigations is necessary to know whether infiltration is feasible. More detailed evaluation may be needed during the design phase to evaluate the suitability of the site for infiltration, establish the infiltration rate for design, and evaluate slope stability, foundation capacity, and other geotechnical design information needed to design and assess constructability of the BMP. See [3.D.2 LID Site Planning](#), for more detailed discussion of soils and subsurface hydrology evaluation.

### **Step 5. Determine the Design Infiltration Rate**

Estimate the design (long-term) infiltration rate as follows:

- Use the large-scale or small-scale PIT method (or other local-approved method) as described in [Appendix 6-B: Guidelines for Site Characterization of Geotechnical Properties](#) to estimate a measured (initial) saturated hydraulic conductivity (Ksat). Alternatively, for sites underlain with soils not consolidated by glacial advance (e.g., recessional outwash soils), the measured Ksat may be estimated using grain size distribution analysis.
- Assume that the Ksat is the measured (initial) infiltration rate for the BMP.
- Adjust this rate using the appropriate correction factors, as described in [3.D.2 LID Site Planning](#).

### **Step 6. Size Stormwater BMPs**



Use an approved modeling method from [Chapter 4 - Hydrologic Analysis and Design](#) to evaluate whether the BMP can infiltrate the 6-month, 24-hour design storm if sizing a runoff treatment BMP. If sizing a BMP to meet the flow control requirement, use an approved modeling method to document that the total of any bypass and overflow meets the applicable flow control standard. Size conveyance BMPs in accordance with local jurisdiction requirements.

### **Step 7. Complete Final Design**

After LID BMPs have been sized, the design team can complete the site design. This step entails updating the preliminary site plan to represent final sizing and BMP layout and confirming that the site goals are met. In many instances, the sizing of the BMPs and the completion of the site plan will involve several iterations.

### **Optional Step: Integrate Performance Monitoring Into Design**

Performance monitoring allows for measurement and direct understanding of how the LID BMPs are performing and compare that with design expectations. These findings can provide valuable feedback and lessons learned to help continually improve future design guidelines and standards, as well as construction practices.

If performance monitoring is desired, then the design of LID BMPs and associated hydraulic structures should consider proposed locations for monitoring equipment early in the design process. For example, locations of flow monitoring gauges may influence design of stormwater pipes (material type, size, and slope), as well as conveyance structures and access for maintenance.

The monitoring data can be used to validate design assumptions, inform future design standards updates, and evaluate the LID site performance based on physical, on-site measurements. If the observed site performance was not meeting goals, adaptive management strategies could be implemented. For example, level spreaders could be installed or fixed to maintain disperse flows, curb cut inlets could be modified if needed to improve capture of stormwater flows, orifice controls could be added or adjusted, etc.

## ***Residential Design Strategies***

### **Low-Density Site Planning Strategies**

Overall site planning concepts in low-density residential settings should include the following:

- Minimizing driveway lengths
- Using permeable driveway surfacing
- Preserving open space and native vegetation
- Conserving native soil

LID site planning strategies for low-density residential sites should focus on locating buildings as close to primary access roads as practical. Reducing access road lengths will reduce total impervious surface. Regardless of access roadway length, roads should use permeable pavement

where feasible. On roads paved with conventional impervious concrete or asphalt surfaces, stormwater runoff should be routed to bioretention BMPs where feasible.

Every effort should be made to minimize storm flow velocities and maximize dispersion to avoid concentrated flows. Slopes with vegetation and nonhardpan soils downhill from proposed buildings and roadways may provide areas for the dispersal of storm flows. Supplemental plantings, soil amendments, and erosion control hydroseeding may also aid in this effort.

Soil conservation is an important site planning strategy. The Natural Resources Conservation Service (NRCS) and the Washington State University Extension offer excellent resources for assessing on-site soil conditions and recommending strategies for soil conservation. Understanding existing soil conditions is fundamental to design and subsequent construction phases.

## **Medium- and High-Density Site Planning Strategies**

### ***Street Layout and Alignment***

“Complete streets” is an increasingly popular urban planning approach that promotes planning, designing, operating, and maintaining streets for safe and convenient use by users of all modes of transportation. In addition to improving safety and convenience of use, complete streets also provide extensive opportunities for LID planning and design within the right-of-way, providing additional benefits of flow control, treatment, and neighborhood amenities as integral features.

The overall objectives for LID, whether part of a complete street or not, are the following:

- Reduce total impervious area (TIA) by reducing the total area of street network (e.g., encourage narrow streets).
- Minimize or eliminate effective impervious area (EIA) and concentrated surface flows on impervious surfaces by reducing or eliminating hardened conveyance structures (e.g., gutters, catch basins, pipes, etc.).
- Infiltrate and slowly convey storm flows in street-side bioretention cells and swales, and through permeable pavements and aggregate storage systems under the pavement.
- Design street networks to minimize site disturbance, avoid sensitive areas, and promote open space connections.
- Promote connectivity in neighborhood street patterns and utilize open space areas to promote walking, biking and access to transit and services.
- Provide safe and efficient fire and emergency vehicle access.

Although reducing TIA and minimizing EIA are overall objectives for LID street design, opportunities to integrate bioretention and permeable pavement should also be explored. There may be a tension between trying to reduce TIA and EIA and providing adequate emergency vehicle access. The number of vehicle access points is usually dictated by the size and intensity of land use and is a function of emergency vehicle requirements.

Emergency vehicle access requirements will dictate the width of streets and the length and dimensions of cul-de-sacs. Balancing safe and adequate access with the desire to limit TIA and EIA through narrower streets may require negotiation. Many jurisdictions have successfully reconciled

these two often competing objectives, in the form of a deviation, in a manner consistent with IFC, Section 503.2, which stipulates a minimum width of 20 feet ([ICC, 2012](#)).

The designer should look for ways of integrating bioretention and permeable pavement into the roadway where feasible. Opportunities abound for retrofitting existing or required buffer strips with bioretention features, and repurposing center medians. The designs should consider that, in eastern Washington, winter snow storage must be accommodated. Storing plowed snow in bioretention BMPs within street right-of-way can be an effective and appropriate strategy for cold climates (see [Figure 3.4: Bioretention Snow Storage](#)). Maintenance plans should include provisions to manage the sediment generated from road sanding.

**Note:** Where existing street standards become a barrier to the implementation of useful LID strategies, it may become necessary to explore adoption of alternative street standard details.

**Figure 3.4: Bioretention Snow Storage**



Source: Yakima Regional Low Impact Development Stormwater Design Manual (Yakima County, 2011)



## Bioretention Snow Storage

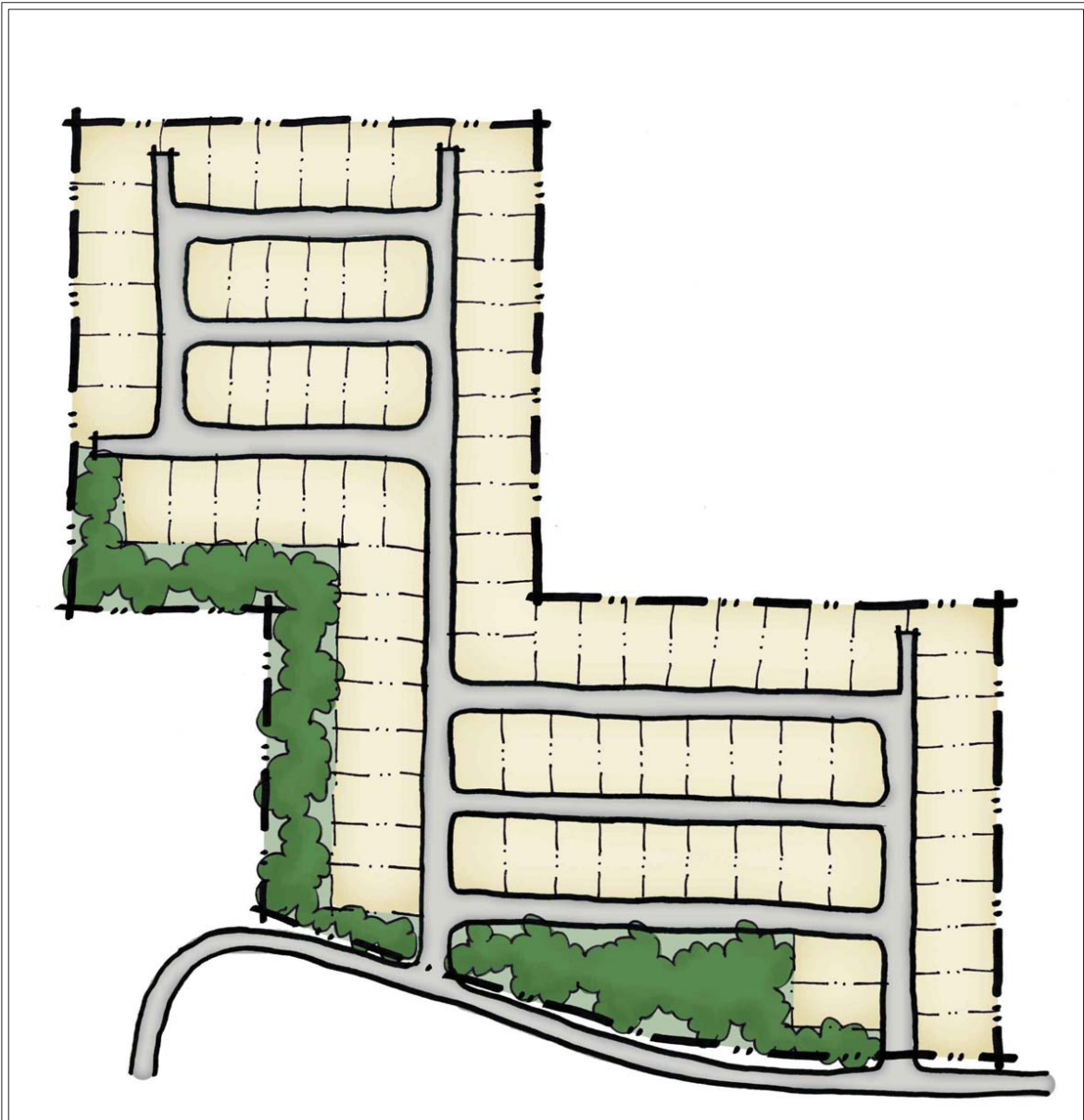
Revised June 2013

Please see <http://www.ecy.wa.gov/copyright.html> for copyright notice including permissions, limitation of liability, and disclaimer.

### **Street Types and Strategies**

Residential street designs generally fall into three categories: grid, curvilinear, or hybrid. [Figure 3.5: Grid Street Network](#) and [Figure 3.6: Curvilinear Street Network](#) illustrate the grid and curvilinear road layouts, and [Table 3.1: Grid and Curvilinear Street Network Comparison](#) from the *Low Impact Development Technical Guidance Manual for Puget Sound* provides a concise summary of the strengths and weaknesses of grid and curvilinear street networks ([WSU - PSP, 2012](#)).

**Figure 3.5: Grid Street Network**



Source: Low Impact Development Technical Guidance Manual for Puget Sound (WSU-PSP, 2012)



## Grid Street Network

Revised June 2013

Please see <http://www.ecy.wa.gov/copyright.html> for copyright notice including permissions, limitation of liability, and disclaimer.

**Figure 3.6: Curvilinear Street Network**



Source: Low Impact Development Technical Guidance Manual for Puget Sound (WSU-PSP, 2012)



## Curvilinear Street Network

Revised June 2013

Please see <http://www.ecy.wa.gov/copyright.html> for copyright notice including permissions, limitation of liability, and disclaimer.

**Table 3.1: Grid and Curvilinear Street Network Comparison**

Street Network	Impervious Coverage	Site Disturbance	Biking, Walking, Transit <sup>a</sup>	Safety	Auto Efficiency
Grid	27% to 36% <a href="#">(CMHC, 2007)</a>	Less adaptive to site features and topography	Promotes by more direct access to services and transit	May decrease by increasing traffic throughout residential area	More efficient – disperses traffic through multiple access points
Curvilinear	15% to 29% <a href="#">(CMHC, 2007)</a>	More adaptive for avoiding natural features, and reducing cut and fill	Generally, discourages through longer, more confusing, and less connected system	May increase by reducing through traffic in dead end streets	Less efficient – concentrates traffic through fewer access points and intersections
Looped	Not included in analysis by <a href="#">(CMHC, 2007)</a>	Moderately adaptive to site topography	Promotes efficient access to services and transit	May decrease by increasing traffic throughout residential area	Moderately efficient distribution of traffic
<sup>a</sup> Biking, walking, and transit are included for livability issues and to reduce auto trips and associated pollutant contribution to receiving waters.					

Grid and curvilinear street networks have both advantages and disadvantages. Grid street networks provide access and circulation that allow for enhanced traffic flow for all transportation modes. Grid networks, however, typically include approximately 20 to 30% more street length than a similar width curvilinear street network ([CWP, 1998](#)). Curvilinear street networks trade minimized impervious surface coverage with poor connectivity that can affect local quality of life. Transportation planners have integrated the two prevalent models into hybrid designs that incorporate the strengths of both (see [Figure 3.7: Loop and Grid Hybrid Street Network](#)).



**Figure 3.7: Loop and Grid Hybrid Street Network**



Source: Low Impact Development Technical Guidance Manual for Puget Sound (WSU-PSP, 2012)



## Loop and Grid Hybrid Street Network

Revised June 2013

Please see <http://www.ecy.wa.gov/copyright.html> for copyright notice including permissions, limitation of liability, and disclaimer.

The following are specific strategies used to create street layouts in medium- to high-density residential developments to minimize impervious surface coverage:

- Cluster structures to reduce overall development footprints and street lengths.
- Allow flexibility in lot width and frontage requirements to reduce overall street lengths.
- Increase block lengths for grid and modified-grid street layouts.
- Reduce cul-de-sac dimensions and integrate landscaping into a center island.
- Allow smaller front yard setbacks to reduce driveway lengths.

Loop streets offer multifunctional street design layouts supporting vehicle and pedestrian needs. A loop street alignment (see [Figure 3.7: Loop and Grid Hybrid Street Network](#)):

- Minimizes impervious road coverage per dwelling unit;
- Provides adequate turning radius for fire and safety vehicles;
- Provides through-flow of traffic with two or more points of access; and
- Provides sufficient area for bioretention in the center of the loop and a visual landscape break for homes facing the street.

Open-space pathways between homes, also called “green streets,” offer open space and pedestrian amenities that can be combined with areas for wet and dry utilities. A green street design provides:

- A connected pedestrian system that takes advantage of open space amenities; and
- Additional stormwater conveyance and infiltration for infrequent, large storm events.

Smaller infill projects can be designed with one access to the development. Ample traffic flow through the project is provided by the loop and along home frontages, allowing for easier movement of fire and safety vehicles. Open space in the center of the loop can provide stormwater storage, a visual landscape break for homes facing the street, and a creative example of integrating a regulatory requirement with a site amenity.

### **Street Width**

Residential street widths and associated impervious surface cover have increased by over 50% since the mid-1900s ([Schueler, 1995](#)). Total and effective impervious area can be significantly reduced by designing BMPs with the narrowest width necessary to meet operational requirements. In addition to the stormwater benefits associated with the reduced impervious surface cover, studies indicate that narrower streets have fewer accidents and are safer ([Kulash, 2001](#)), ([Schueler, 1995](#)).

### **Turnarounds**

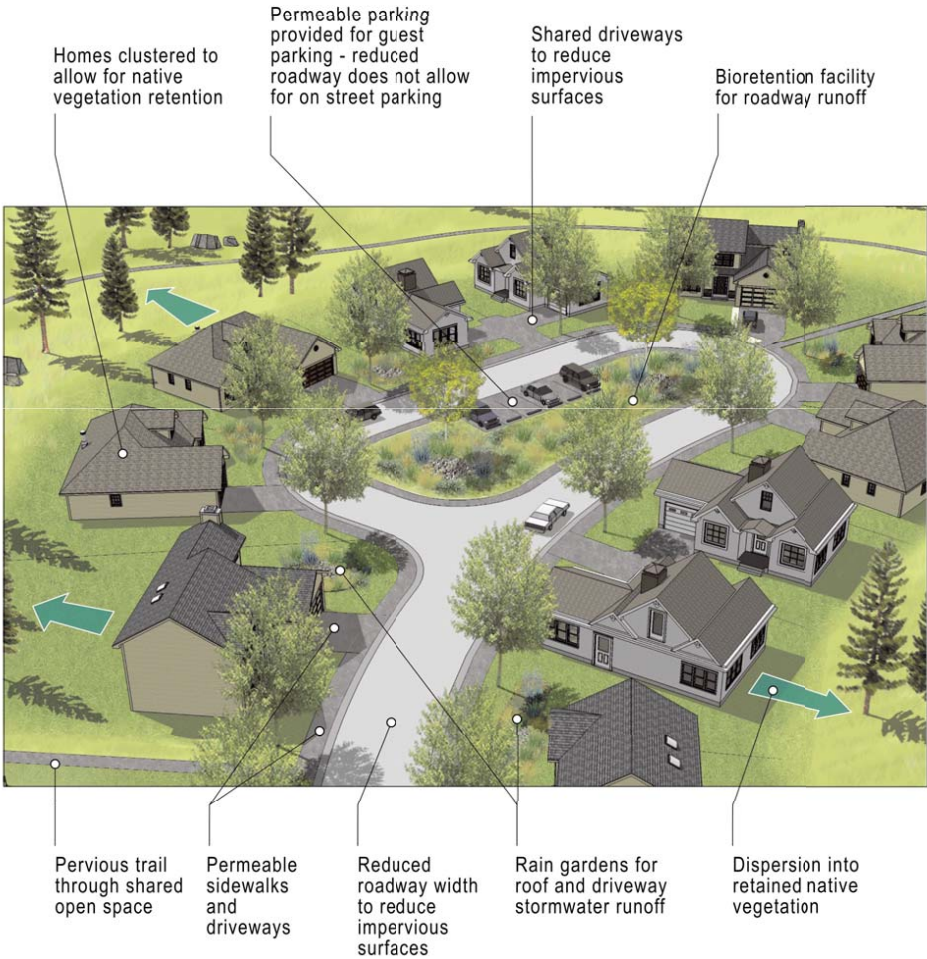
Dead-end streets, particularly cul-de-sacs, can result in excessive impervious surface coverage. In general, dead-end or cul-de-sac streets should be discouraged because they contribute excessive impervious surface coverage and disrupt vehicle and pedestrian circulation. Where site conditions urge the use of a cul-de-sac or other turnarounds, the design should include elements such as landscaped center areas that minimize impervious surface while accommodating emergency vehicle

service and other vehicle needs. A 40-foot radius with a landscaped center should accommodate most service and safety vehicle needs, while maintaining a minimum 20-foot inside turning radius ([Schueler, 1995](#)).

Islands in cul-de-sacs should be designed as retention BMPs where feasible.

The loop street configuration is an alternative to the dead-end street and provides multiple access points for emergency vehicles and residents. For similar impervious surface coverage, the loop street has the additional advantage of increasing available storm flow storage within the loop compared to the cul-de-sac design. [Figure 3.8: Application of LID](#) illustrates the application of an LID loop street configuration in a residential setting.

**Figure 3.8: Application of LID**



Source: AHBL and CleanWater Services



## Application of LID

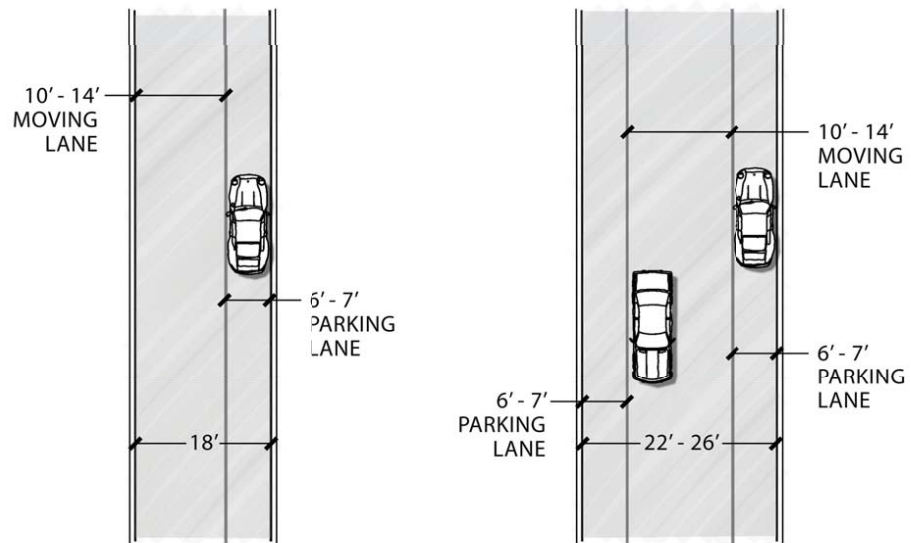
Revised June 2013

Please see <http://www.ecy.wa.gov/copyright.html> for copyright notice including permissions, limitation of liability, and disclaimer.

## ***Parking***

Most zoning ordinances require between 1.5 and 2.5 off-street parking spaces per dwelling unit. Driveways and garages provide the “off-site” element of the requirement for most projects. Consequently, local street classifications that require parking on both sides of the street in addition to two travel lanes result in excessive impervious surface coverage. Parking needs and traffic movement can be met on narrowed streets where one or two on-street parking lanes serve as a traffic lane ([CWP, 1998](#)). [Figure 3.9: Parking and Queuing](#) provides two examples of queuing for local residential streets.

**Figure 3.9: Parking and Queuing**



Source: Low Impact Development Technical Guidance Manual for Puget Sound (WSU-PSP, 2012)



## Parking and Queuing

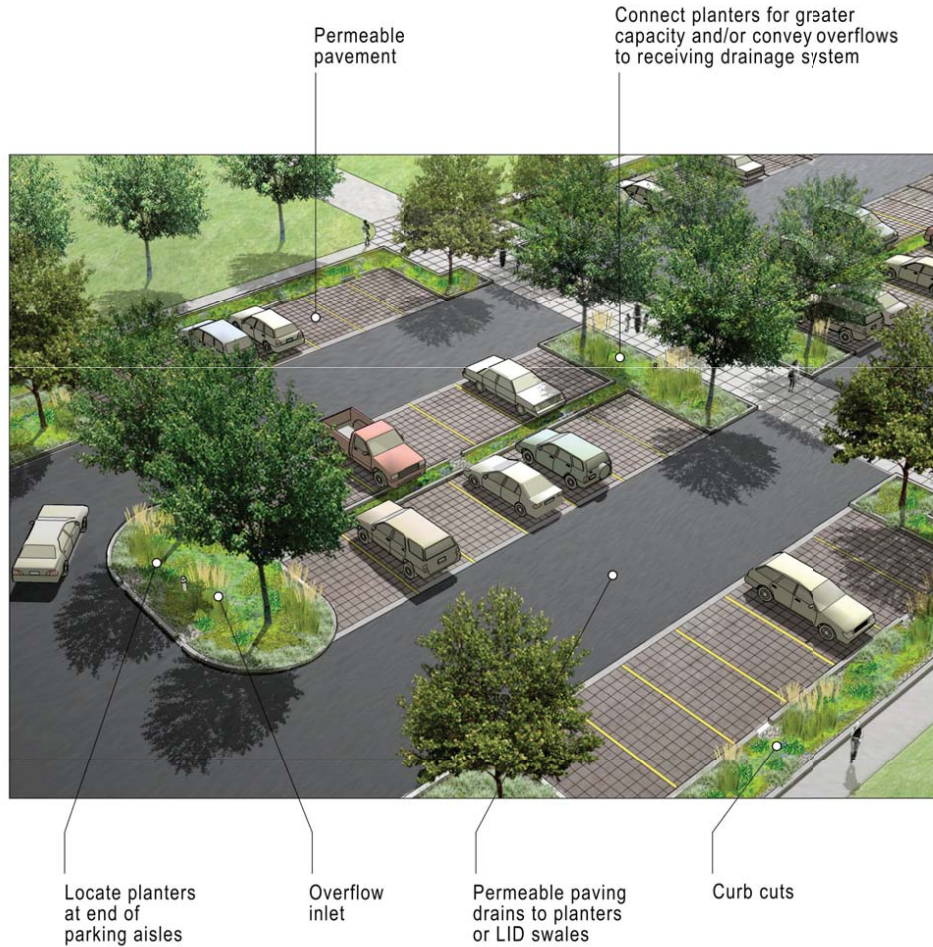
Revised June 2013

Please see <http://www.ecy.wa.gov/copyright.html> for copyright notice including permissions, limitation of liability, and disclaimer.

In higher density residential neighborhoods, pull-out parking can be used. Pull-outs (often designed in clusters of two to four stalls) should be strategically distributed throughout the area to minimize walking distances to residences. Depending on the street design, the parking areas may be more easily isolated and the impervious surface disconnected from other areas by slightly sloping the pavement to adjacent bioretention BMPs.

All or part of pull-out parking areas, queuing lanes or dedicated on-street parking lanes can be designed using permeable paving. Porous asphalt, pervious concrete, permeable pavers, and grid systems can support the load requirements for residential use, reduce or eliminate storm flows from the surface, and possibly be more readily acceptable for use on parking areas with lower loads by jurisdictions hesitant to use permeable pavements in the travel way. Snow management is particularly important in eastern Washington, and the site's long-term snow management plans must be considered early in the planning and design phase. Properly designed, constructed, and maintained permeable pavement can increase snowmelt rates and reduce freezing by allowing air and water to flow through the BMP via infiltration and/or underdrains. [Figure 3.10: Parking Lot Applications](#) illustrates a range of parking lot LID strategies.

**Figure 3.10: Parking Lot Applications**



Source: Low Impact Development Approaches Handbook (CleanWater Services, 2009)



## Parking Lot Applications

Revised June 2013

Please see <http://www.ecy.wa.gov/copyright.html> for copyright notice including permissions, limitation of liability, and disclaimer.



### ***Traffic-Calming Strategies***

Several types of traffic-calming strategies can be used on residential streets to reduce vehicle speeds and increase safety. These design features also offer an opportunity for storm flow infiltration and/or slow conveyance to additional LID BMPs downstream. These features, coupled with narrower street widths are effective LID management strategies. Traffic-calming strategies include the following:

- Traffic circles
- Center planting medians
- Curb extensions or “bulb-outs”
- Curved streets or chicanes

In each case the dimensions of the right-of-way must be adequate to accommodate the calming feature and the feature must be of dimension sufficient to effectively slow traffic. Generally, these traffic-calming strategies should have a minimum dimension of 8 feet. [Figure 3.11: Streetscape Applications](#) illustrates a range of street applications of LID.

**Figure 3.11: Streetscape Applications**



Source: Low Impact Development Approaches Handbook (CleanWater Services, 2009)



## Streetscape Applications

Revised June 2013

Please see <http://www.ecy.wa.gov/copyright.html> for copyright notice including permissions, limitation of liability, and disclaimer.

## **Alleys**

Alleys often provide the primary vehicle access for homes in traditional grid street layouts. Alleys should be the minimum width required to allow: automobile access to garages, snow storage, and adequate area for service vehicles such as refuse trucks.

Strategies to reduce TIA associated with alleys include the following:

- Reducing alley widths from 16 to 20 feet wide to 12 to 16 feet wide
- Inverting crowned alley sections and directing the drainage to a center-line trench draining to bioretention areas
- Using permeable paving materials products such as the following:
  - Pervious concrete
  - Porous asphalt
  - Permeable paver systems
  - Gravel-pave systems
  - Systems integrating multiple types of permeable paving materials

## **Driveways**

As much as 20% of the impervious cover in a residential subdivision can be attributed to driveways ([CWP, 1998](#)). Several techniques can be used to reduce impervious coverage associated with driveways including the following:

- Use shared driveways to provide access to multiple homes. Recommended widths range from 9 to 16 feet serving three to six homes ([Kulash, 2001](#)). A hammerhead or other configuration generating minimal impervious surface may be desirable for turnaround and parking areas.
- Minimize front yard setbacks to reduce driveway length.
- Reduce driveway widths by:
  - Allowing end-to-end garage layouts (widths 10 to 12 feet);
  - Encouraging single car garages (10 to 12 feet);
  - Using permeable pavements; and
  - Limiting pavement to tire travel paths (Hollywood strips or two-track driveways).

## **Sidewalks and Walkable Communities**

Sidewalks are a key element of a walkable community. The elements of a good pedestrian circulation system include the continuity of the network, separation from vehicle traffic, and a width adequate to allow two adults to walk side by side.

In medium-density residential areas, walkways need not be wide, except near schools or libraries. In most cases, pervious surfacing options can be used. The following strategies should be considered in the design of pedestrian circulation systems:

- Reduce sidewalk to a minimum of 48 inches ([36 CFR 1191](#)).
- For low-speed local access streets, provide sidewalks on one side of the street.
- Design a bioretention swale or bioretention cell between the sidewalk and the street to provide a visual break and increase the distance of the sidewalk from the street for safety ([Kulash, 2001](#)). This design will also provide easier navigation by wheelchair users because grade transitions for driveways will be accommodated within the planting strip rather than the sidewalk.
- Install sidewalks with a 2% cross-slope to direct storm flow to bioretention BMPs.
- Use permeable pavements to allow infiltration or increase the time of concentration of storm flows.

### **Stream Crossings**

Numerous studies have correlated increased TIA with declining stream and wetland conditions ([Azous and Horner, 2000](#)), ([Booth et al., 2002](#)), ([May et al., 1997](#)). Research in western Washington suggests that the number of stream crossings per linear foot of stream length may be a stronger indicator of stream health (expressed through Benthic Index of Biotic Integrity) than TIA ([Avolio, 2003](#)).

Site designers should consider minimizing stream crossings because of the significant stress on stream ecological health that can result from concentrating and directing storm flows and contaminants to receiving waters ([Avolio, 2003](#)), ([May et al., 1997](#)). Culvert and bridge designs that place supporting structures in the floodplain or active channel confines streamflows should also be avoided.

## **Commercial and Industrial Design Strategies**

### **Parking**

Parking lots and rooftops are the largest contributors to impervious surface coverage in commercially zoned areas. Typical parking stall dimensions are approximately 9 to 10 feet wide by 18 to 20 feet long. The result is as much as 200 square feet (sf) per stall excluding driveways, access aisles, curbs, landscape islands, and perimeter planting strips. A typical parking lot with these features can require up to 500 sf per vehicle or > 1 acre per 100 spaces. The large EIA coverage associated with parking tends to accumulate high pollutant loads from particulate deposition and vehicle use. As a result, commercial parking lots can produce greater levels of petroleum hydrocarbons and trace metals (cadmium, copper, zinc, and lead) than many other urban land uses ([Schueler, 1995](#)), ([Bannerman et al., 1993](#)).

Most jurisdictions specify parking requirements as a minimum number of spaces that must be provided for the use based on the number of employees, gross floor area, or other parking need metric. While parking infrastructure is a significant expense for commercial development, many national chain retailers have parking formulas that result in the construction of parking that exceeds

standards by 30% to 50% ([Schueler, 1995](#)). In some instances, the total number of parking stalls provided is a function of a peak demand observed only 1 or 2 days each year during the holiday shopping season.

Limiting parking ratios to reflect need is the most effective of several methods to reduce impervious parking coverage. The following strategies to reduce impervious surface coverage, storm flows, and pollutant loads from commercial parking areas should be explored:

- Assess required parking requirements to determine if the minimum number of spaces is within the marketplace of standards. The Institute of Transportation Engineers publishes parking demand for the land uses included in the latest version of its Trip Generation Manual. For more information, refer to the following web address:

<https://www.ite.org/tripgeneration/index.asp>

- Provide incentives to reduce parking by allowing an increase in allowable Floor Area Ratio when transit facilities are provided.
- Establish maximum parking standards that can only be exceeded through the approval of a parking study. Many communities express the maximum parking standard as a function or a percentage of its minimum parking standard.
- Allow 20% to 30% of parking to compact spaces (typically 7.5 by 15 feet).
- Use a diagonal parking stall configuration with a one-way drive aisle between stalls to reduce width of parking stalls. This design solution, where feasible, can result in a reduction of overall lot coverage by 5% to 10%.
- Consider structured parking where density and land values warrant. Structured parking can be located underground or at-grade below the building for a multistory structure.
- Use permeable pavement materials for driveways, drive aisles, parking spaces, and walkways where feasible.
- Designs should include appropriate measures for protecting sole source aquifers (e.g., treatment liners, underdrains, etc.) where applicable.
- Integrate bioretention into parking lot islands or planter strips distributed throughout the parking area to infiltrate, store, and/or slowly convey storm flows. Where allowed, credit these bioretention BMPs toward landscaping requirements that may apply to the interior or perimeter of a parking lot.
- Encourage cooperative parking agreements to coordinate use of adjacent or nearby parking areas that serve land uses with noncompeting hours of operation.

### **Building Design**

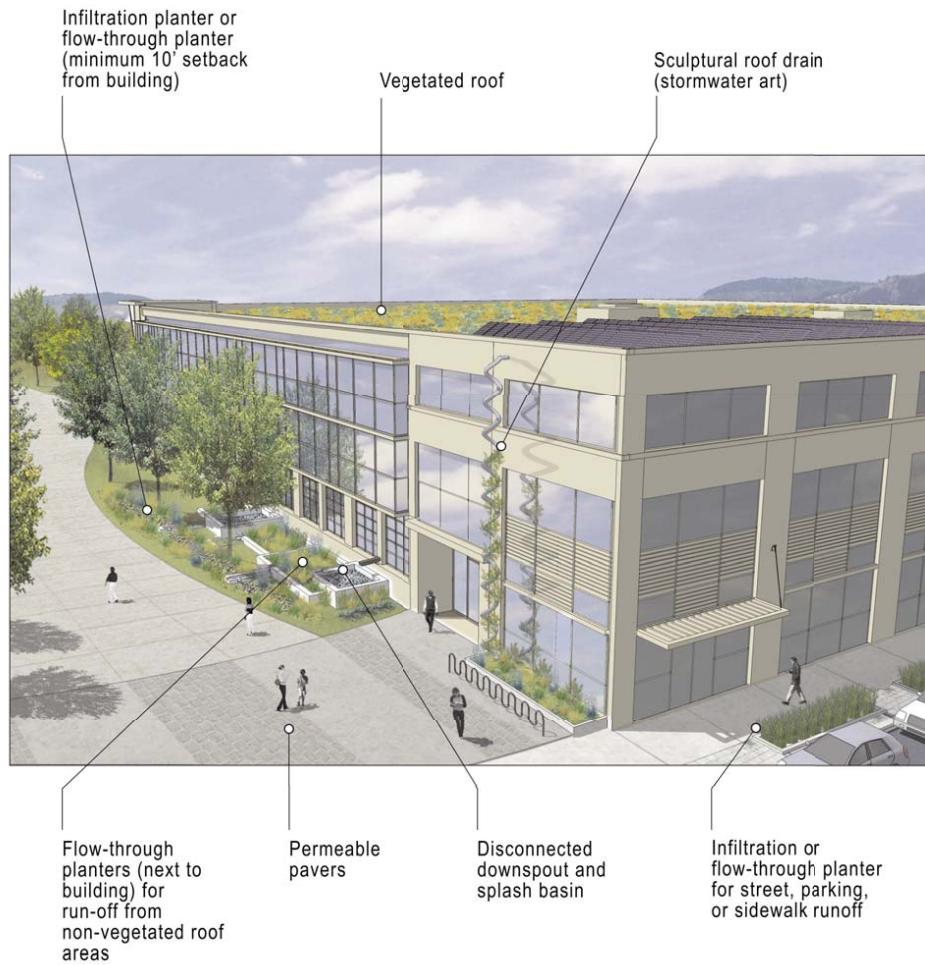
Objectives for building design are to minimize storm flows and site disturbance, using the following types of strategies ([Figure 3.12: Building Applications](#)):

- Reducing building footprints by designing smaller and/or taller structures. Smaller building footprints can result in less land disturbance during construction. Proposals to construct taller

buildings can also present specific fire, safety, and health issues that may need to be addressed. For example, multifamily residences over 2.5 stories may require a fire escape and/or a sprinkler system.

- Using vegetated roofs or heavily landscaped rooftop patio areas, with generous landscaped planters. Vegetated roofs are routinely used in other arid or semiarid part of the country for managing stormwater, as well as the economic benefits associated with improved aesthetics, increased useable space, and reduced energy consumption due to the insulating properties of the roof.
- Capturing, harvesting and reusing rooftop rain water for irrigation or other nonpotable building water through cisterns or other rain water collection systems. Rain water reuse is especially applicable for areas where infiltration is not feasible, such as sites situated over sole source aquifers, high water tables, or shallow depth to bedrock.
- Controlling roof water on-site and direct roof drainage to splash blocks and bioretention BMPs.
- Using minimal excavation foundations where appropriate.
- Limiting clearing and grading of the site.

**Figure 3.12: Building Applications**



Source: Low Impact Development Approaches Handbook (CleanWater Services, 2009)



## Building Applications

Revised June 2013

Please see <http://www.ecy.wa.gov/copyright.html> for copyright notice including permissions, limitation of liability, and disclaimer.

*This page has been intentionally left blank for double-sided printing.*



# Chapter 4 - Hydrologic Analysis and Design

## 4.1 Introduction

The purpose of this chapter is to provide guidance for sizing runoff treatment Best Management Practices (BMPs) to protect the quality of receiving waters and flow control BMPs to protect stream morphology and habitat.

The chapter does *not* provide guidance for sizing flood control BMPs, conveyance systems, or subsurface infiltration BMPs (drywells), but these methods may be used for design of those and other stormwater infrastructure components. Contact the local jurisdiction regarding design criteria and requirements.

In the general design of flow control BMPs, the optimal placement of multiple small-scale retention/infiltration BMPs within a contributing area may require less total storage capacity to meet a given peak flow rate target than a single large BMP at the outlet of the contributing area.

*This page has been intentionally left blank for double-sided printing.*

## 4.2 Hydrologic Analysis Methods and Applicability

### 4.2.1 Introduction

One or more of the following methods may be approved to analyze stormwater runoff from projects for design of runoff treatment Best Management Practices (BMPs) in a jurisdiction:

- Single-event hydrograph methods:
  - Soil Conservation Service (SCS) hydrograph
  - Santa Barbara Urban Hydrograph (SBUH)
- SCS curve number equations
- Level-pool routing method
- Rational Method

Flow control BMPs must be sized using a single-event hydrograph method and the level-pool routing method. If available and approved, a continuous runoff model or other hydrograph modeling method may be used.

Other hydrograph models based on peer-reviewed methods and supported by local data also may be approved by agencies or local jurisdictions; some may require special expertise and experience in their application.

[Table 4.1: Comparison of Hydrologic Analysis Methods for Runoff Treatment and Flow Control BMP Design](#) provides a short description of each of the hydrologic analysis methods, summarizes the advantages and disadvantages of each method, and summarizes the situations in which each of these methods may be used. [4.5 Single-Event Hydrograph Methods](#) through [4.8 Rational Method](#) describe their use in greater detail.

**Table 4.1: Comparison of Hydrologic Analysis Methods for Runoff Treatment and Flow Control BMP Design**

Method	Description	Advantages	Disadvantages	Applicability
Soil Conservation Service (SCS) hydrograph	Single-event hydrograph method that involves routing a proposed development hydrograph and rainfall distribution through a BMP to compare against allowable release rates.	Commercially available computer programs	Some SCS hydrograph models such as TR-55 are restricted to 24-hour hyetographs and will not allow the regional and short-duration storm hyetographs developed for eastern Washington.	<ul style="list-style-type: none"> <li>• Flow control BMPs (required)</li> <li>• Peak flow rates and runoff volumes for runoff treatment BMPs (allowed)</li> </ul>
Santa Barbara Urban Hydrograph (SBUH)		<ul style="list-style-type: none"> <li>• Commercially available computer programs</li> <li>• Most accurate for small basins (&lt; 100 acres)</li> </ul>	<ul style="list-style-type: none"> <li>• Not accurate for large basins (<math>\geq 100</math> acres) where ground water flow can be a major contributor to the total flow</li> <li>• Should not be used for basins &gt; 1,000 acres</li> </ul>	
Soil Conservation Service (SCS) curve number (CN) equations	Estimate total runoff volume based on precipitation depth and CN. Typically used in conjunction with a single-event hydrograph method (SCS hydrograph or SBUH).	<ul style="list-style-type: none"> <li>• Does not require use of a computer program; can be determined using a calculator</li> <li>• Commonly used for small and large basins</li> </ul>	<ul style="list-style-type: none"> <li>• Is not linked to a rainfall distribution (only precipitation depth)</li> <li>• Selection of CN is inherently subjective and may require adjustment for high ground water, shallow bedrock, soil compacted by heavy equipment, etc.</li> <li>• Method origins are from large rural basins</li> </ul>	Runoff volumes for runoff treatment BMPs (based on SCS hydrograph method)
Level-pool routing method	Method to route a hydrograph through an existing retention/detention BMP or closed depression. Typically used in conjunction with a single-event hydrograph method (SCS or SBUH).	Commercially available computer programs	None identified	Flow control BMPs (required)
Rational Method	Calculation based on $Q = CIA$ , where: <ul style="list-style-type: none"> <li>• <math>Q</math> = runoff (cfs)</li> </ul>	<ul style="list-style-type: none"> <li>• Does not require use of a computer program; can be determined using a</li> </ul>	<ul style="list-style-type: none"> <li>• Precipitation intensity is variable and does not fall at a constant rate</li> </ul>	<ul style="list-style-type: none"> <li>• Flow-rate-based treatment BMPs</li> </ul>

**Table 4.1: Comparison of Hydrologic Analysis Methods for Runoff Treatment and Flow Control BMP Design (continued)**

Method	Description	Advantages	Disadvantages	Applicability
	<ul style="list-style-type: none"> <li>• C = runoff coefficient based on land cover and slope</li> <li>• I = rainfall intensity (inches/hour)</li> <li>• A = contributing area (acres)</li> </ul>	<p>calculator</p> <ul style="list-style-type: none"> <li>• Most accurate for small basins (&lt; 100 acres) and developed conditions with large areas of impervious surface (e.g., pavement, rooftops)</li> </ul>	<ul style="list-style-type: none"> <li>• Not accurate for large basins (<math>\geq 100</math> acres) since the effects of infiltration are often not properly accounted for</li> <li>• Should not be used for basins &gt; 1,000 acres</li> </ul>	<p>(allowed)</p> <ul style="list-style-type: none"> <li>• Used for biofiltration swale, oil and water separator, and drywell sizing</li> <li>• Used for conveyance system sizing</li> </ul>
Modified Rational Method (Bowstring Method)	This method is used to estimate storage requirements for a given design storm using a series of hydrographs for different storm durations.	Produces a peak flow rate and runoff volume (compared to peak flow rate only for the Rational Method)	<ul style="list-style-type: none"> <li>• May underestimate the required storage volume for any given storm event</li> <li>• Limited to contributing areas &lt; 20 acres with generally uniform surface cover and topography</li> </ul>	Peak flow rates and runoff volumes
Water Budget Method	This method uses average monthly precipitation and pan evaporation values to estimate the net stormwater runoff volume increase during a 2-year cycle.	Accounts for seasonal variations in precipitation, pan evaporation, and antecedent runoff conditions	<ul style="list-style-type: none"> <li>• May be difficult to account for imported water sources (e.g., irrigation, septic systems, natural springs, foundation drains, dewatering wells, etc.)</li> <li>• May be difficult to account for ground water seepage</li> </ul>	Evaporation pond design
Other hydrograph models	Peer-reviewed methods and supported by local data	Varies	Varies	Varies

## 4.2.2 Hydrologic Analysis for Core Element #5: Runoff Treatment

Runoff treatment BMPs designed to meet [2.7.6 Core Element #5: Runoff Treatment](#) treat stormwater runoff from pollution-generating surfaces. Each runoff treatment BMP is sized based on a water quality design volume, or a water quality design flow rate. [2.7.6 Core Element #5: Runoff Treatment](#) identifies the design volume or flow rate that needs to be treated. Agencies and local jurisdictions should adopt criteria to provide for consistent sizing of runoff treatment BMPs (see [2.7.6 Core Element #5: Runoff Treatment](#)). Various modeling approaches can be used to determine design and sizing requirements for runoff treatment BMPs; the recommended methods for predicting runoff volumes and flow rates are included in this chapter. Specific design criteria for runoff treatment BMPs also may be identified in [Chapter 5 - Runoff Treatment BMP Design](#) in order to achieve the performance goal of a particular BMP.

## 4.2.3 Hydrologic Analysis for Core Element #6: Flow Control

Flow control BMPs designed to meet [2.7.7 Core Element #6: Flow Control](#) are intended to protect stream morphology and habitat; flood control and conveyance are not addressed. [2.7.7 Core Element #6: Flow Control](#) identifies the requirements for hydrologic analysis when designing flow control BMPs to protect stream morphology and habitat. [2.7.7 Core Element #6: Flow Control](#) also lists projects and locations that are exempt from the flow control requirement. In order to design a flow control BMP, a hydrograph model must be used to compare the predevelopment or existing condition to the postdevelopment condition. Agencies and local jurisdictions may impose predetermined or other stricter predevelopment or existing condition parameters. The suggested hydrograph method is a single-event hydrograph such as the SCS hydrograph or the SBUH method; agencies or local jurisdictions may adopt other methods to meet the intent of the flow control requirement and/or they may also require more stringent design criteria. SCS curve number equations may not be used to design flow control BMPs.

## 4.3 Design Storm Distributions

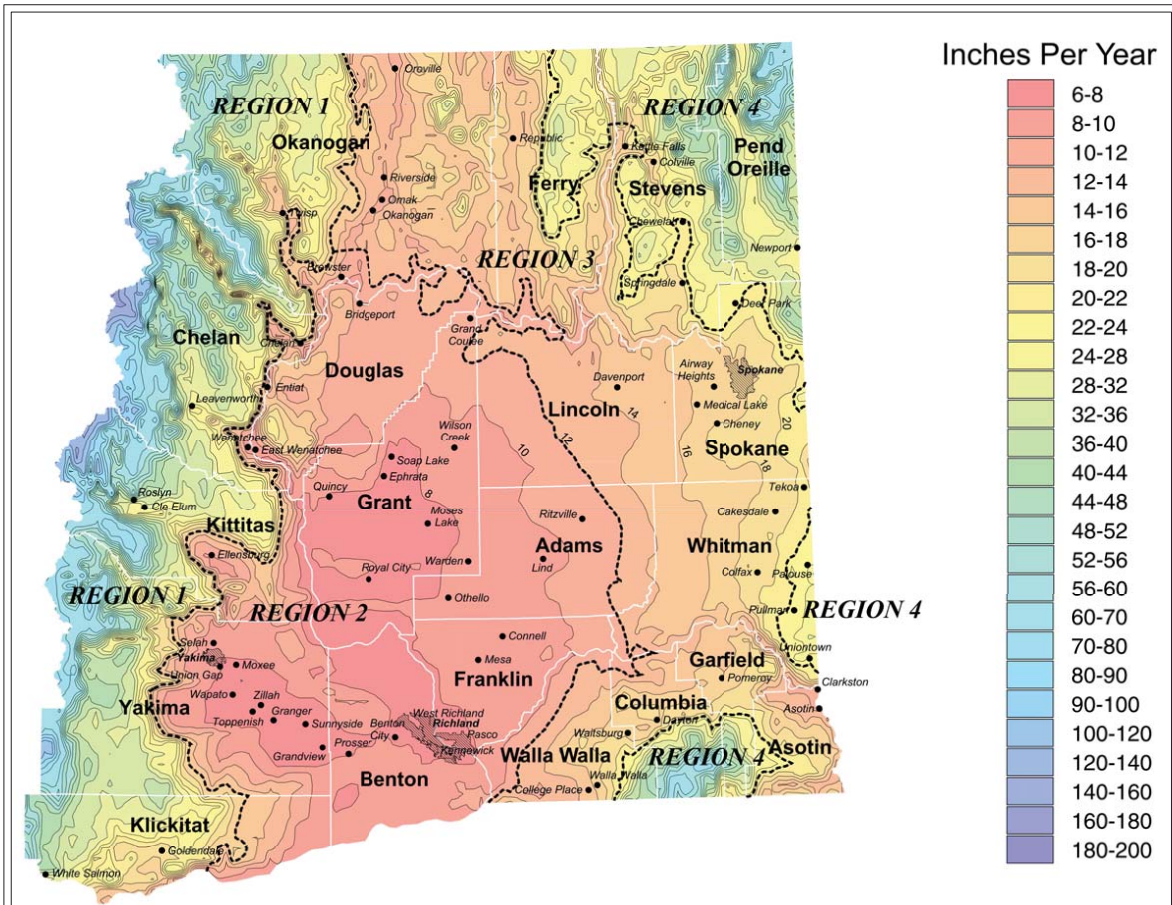
### 4.3.1 Climate Regions

Eastern Washington has been divided into four climate regions to reflect the differences in storm characteristics and the seasonality of storms. The boundaries of these climate regions are based on average annual precipitation contours as shown in [Figure 4.1: Average Annual Precipitation and Climate Regions](#). See [4.3.6 Precipitation Magnitude/Frequency Analysis](#) and [4.3.7 Precipitation Magnitude and Frequency for 24-Hour and Regional Storms](#) for isopluvial maps used for sizing flow control and runoff treatment Best Management Practices (BMPs). Additional isopluvial maps can be found in [4.4 Precipitation Maps](#). The four climate regions are summarized in [Table 4.2: Climate Region Summary](#).

**Table 4.2: Climate Region Summary**

Climate Region	Description	Average Annual Precipitation Range	Average Annual Precipitation Boundaries
Climate Region 1: East Slopes of Cascade Mountains	This climate region consists of mountain areas on the east slopes of the Cascade Mountains.	16 to > 60 inches	<ul style="list-style-type: none"> <li>• Western boundary: Cascade crest</li> <li>• Eastern boundary: 16 inches</li> </ul>
Climate Region 2: Central Basin	This climate region consists of the Columbia Basin and adjacent low-elevation areas in central Washington.	<ul style="list-style-type: none"> <li>• 6 to 16 inches</li> <li>• Majority of cities = 8 inches of average annual precipitation</li> </ul>	<ul style="list-style-type: none"> <li>• Western boundary: 16 inches</li> <li>• Eastern boundary: 12 inches</li> <li>• Northern boundary: 2 to 14 inches</li> </ul>
Climate Region 3: Okanogan, Spokane, Palouse	This climate region consists of intermountain areas and includes areas near Okanogan, Spokane, and the Palouse.	12 to 22 inches	<ul style="list-style-type: none"> <li>• Northwest boundary: 16 inches</li> <li>• Southwest boundary: 12 inches</li> <li>• Northeast boundary: 22 inches</li> <li>• Southeast boundary: 22 inches</li> </ul>
Climate Region 4: Northeastern Mountains and Blue Mountains	This climate region consists of mountain areas in the easternmost part of Washington.	22 to > 60 inches	<ul style="list-style-type: none"> <li>• Northeast boundary: 22 inches</li> <li>• Southern boundary: 22 inches</li> <li>• Western boundary: 22 inches</li> </ul>

**Figure 4.1: Average Annual Precipitation and Climate Regions**



Average Annual Precipitation  
1961-1990  
With Climate Regions

SOURCE: Oregon Climate Service, U.S.  
Department of Agriculture, Natural  
Resources Conservation Service

Map projection: State Plane Washington South, NAD 27

**REGION 1:** East Slope Cascades

**REGION 2:** Central Basin

**REGION 3:** Okanogan, Spokane, Palouse

**REGION 4:** NE & Blue Mountains



## Average Annual Precipitation and Climate Regions

Revised March 2002

Please see <http://www.ecy.wa.gov/copyright.html> for copyright notice including permissions, limitation of liability, and disclaimer.

## 4.3.2 Distributions and Applicability

The design storms to be used in eastern Washington specify the following:

- Total rainfall volume (depth in inches)
- Rainfall distribution (dimensionless)

[4.6.3 Curve Number](#) through [4.3.8 Precipitation Magnitude and Frequency for Short-Duration Storms](#) describe the total precipitation depth and precipitation distribution associated with a design storm. The design storm event is also specified by return period (months and/or years) and duration.

All rainfall-runoff hydrograph methods require the input of a rainfall distribution or design storm hyetograph. The hyetograph represents the portion of the total precipitation depth that falls during each increment of time for a given overall duration. It is usually presented as a dimensionless plot or table of unit precipitation depth (incremental precipitation depth for each time interval divided by the total precipitation depth) versus time.

[Table 4.3: Comparison of Design Storm Distributions](#) provides a short description of each of the following design storm distributions or precipitation depth options, summarizes the advantages and disadvantages of each distribution, and summarizes the applicability for when these distributions or depths may be used:

- 3-hour short-duration storm distribution
- 24-hour or longer regional storm distribution (based on the 72-hour long-duration storm for each climate region)
- 24-hour Soil Conservation Service (SCS) Type IA storm distribution
- Modified 24-hour SCS Type IA storm distribution
- 24-hour SCS Type II storm distribution
- Site runoff of 0.5 inches, depth only, no distribution
- 2-year mean precipitation depth (no distribution)
- Other design criteria adopted by agencies or local jurisdictions that meet or exceed the intent of the Core Elements for runoff treatment and flow control

The first five distributions listed (3-hour short-duration storm and 24-hour or longer storms) are discussed in further detail in [4.3.3 Short-Duration and Regional Design Storms](#) through [4.3.5 Modified SCS Type IA and Regional Design Storms](#). Tabular values for the hyetographs associated with these storms are provided in [Appendix 4-D: Design Storm Hyetographs](#).



**Table 4.3: Comparison of Design Storm Distributions**

<p><b>3-Hour Short-Duration Storm: A synthetic 3-hour custom design storm that represents rainfall during a typical summer thunderstorm in eastern Washington. Typically includes peak discharge in small urban watersheds.</b></p>		
<p><b>Advantages</b></p> <p>Important where flood peak discharge and/or erosion are design considerations.</p>	<p><b>Disadvantages</b></p> <p>Only one short-duration storm for all four climate regions in eastern Washington.</p>	<p><b>Applicability</b></p> <ul style="list-style-type: none"> <li>• Flow-rate based treatment BMPs.</li> <li>• Conveyance structures.</li> </ul>
<p><b>Regional Storm: A synthetic distribution that represents the second event of the “long-duration storm” hydrograph (with lower rainfall intensities and larger runoff volumes than the short-duration storm). Includes more total precipitation than the 24-hour SCS Type IA, but are spread over more time.</b></p>		
<p><b>Advantages</b></p> <ul style="list-style-type: none"> <li>• Important where both runoff volume and peak discharge are design considerations.</li> <li>• Separate long-duration storms were developed for each of the four eastern Washington climate regions.</li> <li>• Storms are similar to the SCS Type IA storm for Climate Region 2 (no measurable difference), Climate Region 3 (&lt; 7% greater), and Climate Region 4 (&lt; 7% greater).</li> </ul>	<p><b>Disadvantages</b></p> <ul style="list-style-type: none"> <li>• First event of the “long-duration storm” hydrograph is not modeled.</li> <li>• Soil wetting produced by the first event must be accounted for by adjusting the modeling input parameters.</li> <li>• Storm does not match the SCS Type IA storm for Climate Region 1 (16% greater precipitation depth and 40% longer duration).</li> </ul>	<p><b>Applicability</b></p> <ul style="list-style-type: none"> <li>• Flow control BMPs.</li> <li>• Volume-based treatment BMPs.</li> </ul>
<p><b>24-Hour Soil Conservation Service (SCS) Type IA Storm: Lower rainfall intensities than the SCS Type II hydrograph.</b></p>		
<p><b>Advantages</b></p> <ul style="list-style-type: none"> <li>• Similar to the four regional storms.</li> <li>• Recent analysis supports use in eastern Washington.</li> <li>• May produce acceptable results without the added complexity of the regional storm.</li> <li>• 24-hour duration allows for easy use of</li> </ul>	<p><b>Disadvantages</b></p> <p>Not applicable to flow control BMP sizing in all climate regions.</p>	<p><b>Applicability</b></p> <ul style="list-style-type: none"> <li>• Flow control BMPs in Climate Regions 2 and 3.</li> <li>• Volume-based treatment BMPs.</li> </ul>

**Table 4.3: Comparison of Design Storm Distributions (continued)**

<p>the built-in storm pattern feature of most SCS Method software which reduces the potential for computational errors due to incorrect implementation of unique duration hydrographs.</p>		
<p><b>Modified 24-Hour SCS Type IA Storm: Antecedent moisture conditions and precipitation depths are adapted from the SCS Type IA storm to more closely reflect typical conditions in eastern Washington.</b></p>		
<p><b>Advantages</b></p> <p>Intended to more closely reflect historical precipitation patterns in eastern Washington compared to the standard Type IA design storm.</p>	<p><b>Disadvantages</b></p> <ul style="list-style-type: none"> <li>• Curve numbers (CNs) need to be adjusted based on engineering analysis and judgment of antecedent precipitation, soil characteristics, and surface conditions.</li> <li>• Not applicable to flow control BMP sizing for large projects (<math>\geq 1</math> acre).</li> <li>• Not applicable to flow control BMP sizing in all climate regions.</li> </ul>	<p><b>Applicability</b></p> <ul style="list-style-type: none"> <li>• Flow control BMPs at small projects (<math>&lt; 1</math> acre) in Climate Regions 1 and 4.</li> <li>• Volume-based treatment BMPs.</li> </ul>
<p><b>24-Hour SCS Type II Storm: Hyetograph with high-intensity peak.</b></p>		
<p><b>Advantages</b></p> <p>Has been used in eastern Washington (and throughout the United States) since the 1970s.</p>	<p><b>Disadvantages</b></p> <p>Does not match historical records for the short-duration storm and the long-duration storm in eastern Washington.</p>	<p><b>Applicability</b></p> <ul style="list-style-type: none"> <li>• Volume-based treatment BMPs.</li> <li>• Flow-rate based treatment BMPs.</li> </ul>
<p><b>One-Half Inch of Runoff: Precipitation depth only, no distribution; included as Method 2 for Bioinfiltration Swales (BMP T5.30) in Chapter 5.</b></p>		
<p><b>Advantages</b></p> <p>Simple to apply (precipitation depth only, no distribution).</p>	<p><b>Disadvantages</b></p> <ul style="list-style-type: none"> <li>• Does not require treatment of permeable surfaces.</li> <li>• Does not give credit for infiltration through the</li> </ul>	<p><b>Applicability</b></p> <ul style="list-style-type: none"> <li>• Runoff treatment volumes in Climate Regions 2 and 3.</li> </ul>

**Table 4.3: Comparison of Design Storm Distributions (continued)**

	bottom of a bioinfiltration swale.	<ul style="list-style-type: none"> <li>• One of the methods for sizing bioinfiltration swales in Climate Regions 2 and 3.</li> </ul>
<p><b>2-Year Mean Precipitation Depth:</b> Precipitation depth only, no distribution; used for determining peak flow rate by the Rational Method.</p>		
<p><b>Advantages</b></p> <p>Most accurate for small basins (&lt; 100 acres) and developed conditions with large areas of impervious surface (e.g., pavement, rooftops).</p>	<p><b>Disadvantages</b></p> <ul style="list-style-type: none"> <li>• Precipitation intensity is variable and does not fall at a constant rate.</li> <li>• Not accurate for large basins (<math>\geq 100</math> acres) since the effects of infiltration are often not properly accounted for.</li> <li>• Should not be used for basins &gt; 1,000 acres.</li> </ul>	<p><b>Applicability</b></p> <ul style="list-style-type: none"> <li>• Flow-rate based treatment BMPs.</li> <li>• Used with the Rational Method for bioinfiltration swale, oil and water separator, and drywell sizing.</li> <li>• Used with the Rational Method for conveyance system sizing.</li> </ul>

### 4.3.3 Short-Duration and Regional Design Storms

Rainfall patterns during storms in eastern Washington were analyzed to identify short-duration and regional rainfall distributions for climate regions in eastern Washington (see [Appendix 4-A: Background Information on Design Storms and Selected Modeling Methods](#)). Two primary storm types are of interest to hydrologic analysis for design of stormwater BMPs in eastern Washington: the thunderstorms and general storms. Thunderstorms are represented by the short-duration storm distribution and general storms are represented by the regional storm distribution. Both design storms were developed in a manner that replicated temporal characteristics observed in storms from climatologically similar areas in and near eastern Washington. See [Table 4.3: Comparison of Design Storm Distributions](#) for the advantages and disadvantages and a summary of the situations in which these design storms may be used.

See [Appendix 4-A: Background Information on Design Storms and Selected Modeling Methods](#) for further discussion of the development and review of these design storms. [4.A.3 Review of Design Storms and Identification of Best Rainfall-Runoff Modeling Approaches for Eastern Washington](#)

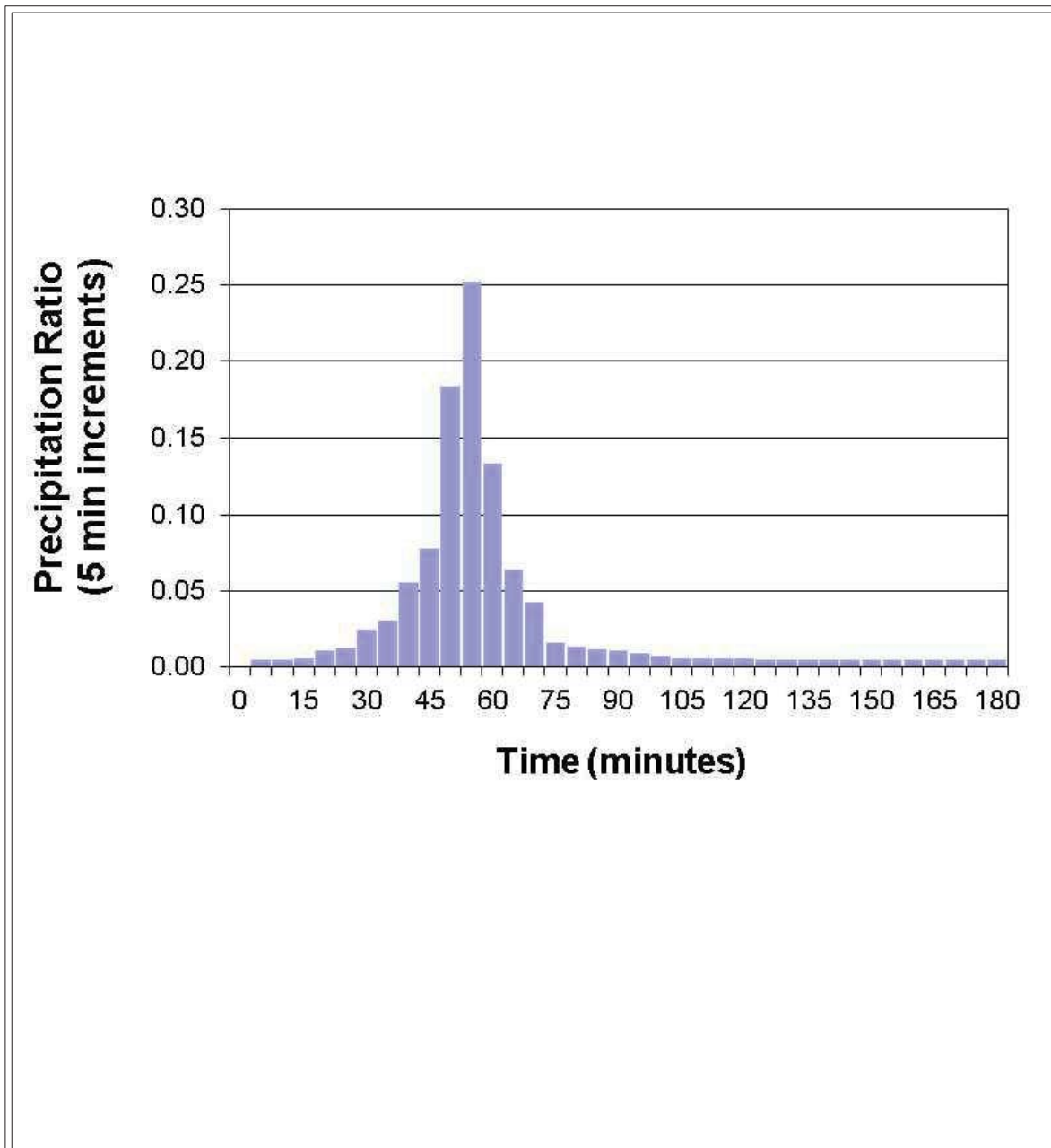
includes a graphical representation of the standard SCS Type IA and II synthetic design storms and the long-duration storms for comparison on a unit basis.

### ***Short-Duration Design Storm***

Thunderstorms (short-duration storms) can occur in late spring through early fall and are characterized by high intensities for short periods of time over localized areas. Short-duration storms can produce high rates of runoff and flash flooding in urban areas and are important where flood peak discharge and/or erosion are design considerations. The effect of short-duration storms should also be considered in designing BMPs based on other design storms.

The short-duration storm hyetograph is 3 hours in duration. The storm temporal pattern is shown in [Figure 4.2: Short-Duration Storm Unit Hyetograph](#) as a unit hyetograph. Tabular values for this hyetograph are listed in [Table 4.33: Short-Duration Storm Hyetograph Values for All Climate Regions](#). Total precipitation is 1.06 times the 2-hour precipitation amount. There is one short-duration storm for all climate regions in eastern Washington.

**Figure 4.2: Short-Duration Storm Unit Hyetograph**



### Short-Duration Storm Unit Hyetograph

Revised September 2004

Please see <http://www.ecy.wa.gov/copyright.html> for copyright notice including permissions, limitation of liability, and disclaimer.

## **Regional Storm**

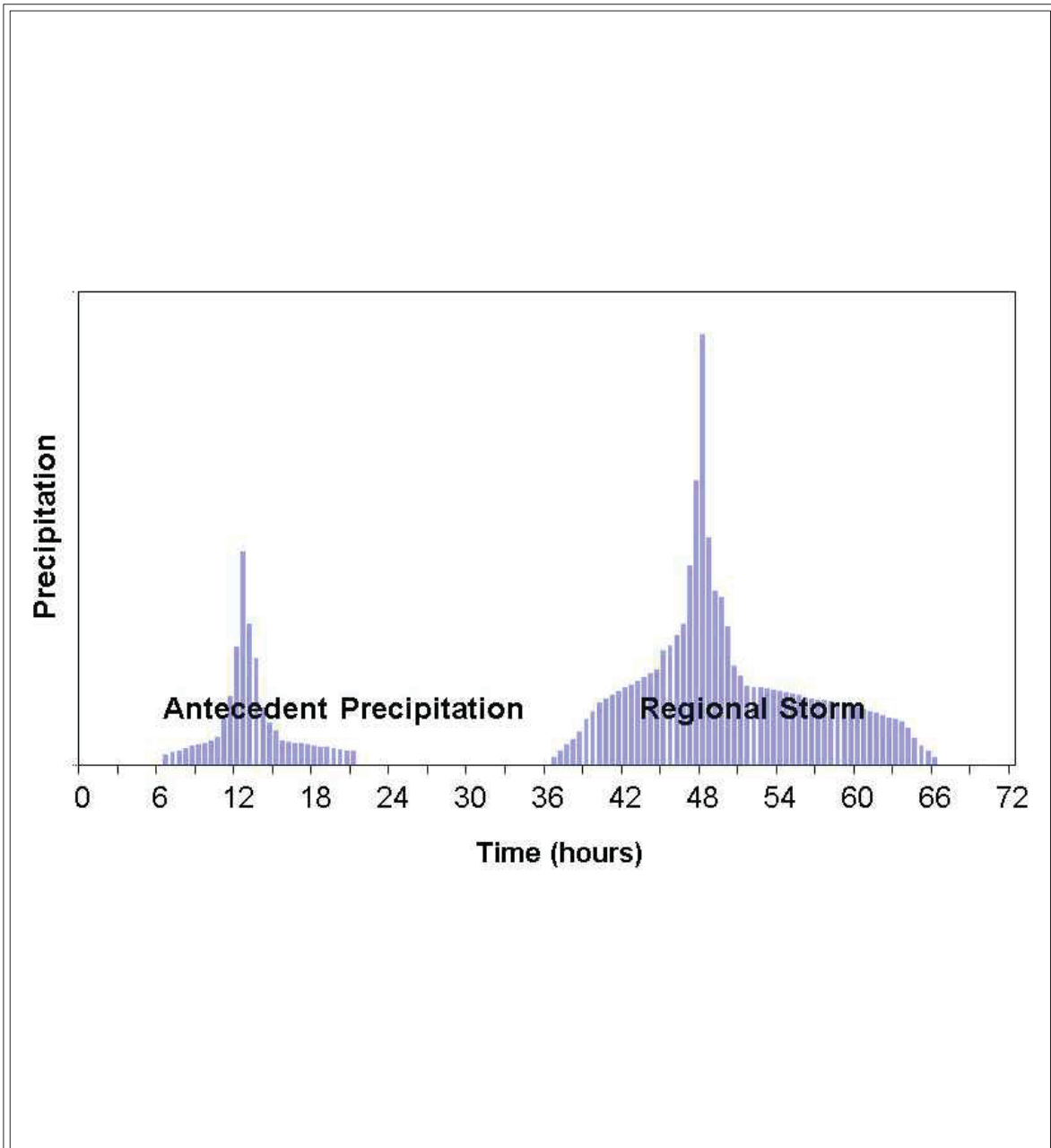
General storms (regional storms) can occur at any time of the year, but are more common in the late fall through winter period, and in the late spring and early summer periods. Regional storms in eastern Washington are characterized by sequences of storms and intervening dry periods, often occurring over several days. Low- to moderate-intensity precipitation is typical during the periods of storm activity. Regional storms can produce floods with moderate peak discharge and large runoff volumes. The runoff volume can be augmented by snowmelt when precipitation falls on snow during winter and early spring storms. Regional storms are important where both runoff volume and peak discharge are design considerations.

The synthetic distribution represents a series of two rainfall events separated by a dry intervening period and occurring during a total 72-hour period of time. A sample 72-hour long-duration storm hyetograph is shown in [Figure 4.3: Sample Regional Storm Hyetograph](#).

The regional storms are derived from these hyetographs (see [Appendix 4-A: Background Information on Design Storms and Selected Modeling Methods](#)). The first, smaller precipitation event (occurring from 6 to 21 hours in [Figure 4.3: Sample Regional Storm Hyetograph](#)) is generally insufficient to generate runoff that is present when the larger second precipitation event commences and for that reason it is deemed unnecessary to directly model the smaller precipitation event and only the second, larger portion (beginning at 36 hours in [Figure 4.3: Sample Regional Storm Hyetograph](#)) is directly modeled. However, the soil wetting produced by the first event must still be accounted for by appropriately adjusting the modeling input parameters.

Tabular values of the regional storm hyetographs are listed in [Table 4.34: Regional Storm Hyetograph Values for Climate Region 1: Cascade Mountains](#) through [Table 4.37: Regional Storm Hyetograph Values for Climate Region 4: Eastern Mountains](#). The regional storms are similar to the 24-hour SCS Type IA storm distribution. An adapted version of applying the Type IA distribution is discussed in [4.3.5 Modified SCS Type IA and Regional Design Storms](#). Comparison of precipitation depth, antecedent moisture condition (AMC), and necessary adjustments and modeling requirements for the regional storms are discussed in [4.3.5 Modified SCS Type IA and Regional Design Storms](#).

**Figure 4.3: Sample Regional Storm Hyetograph**



### Sample Regional Storm Hyetograph

Revised September 2004

Please see <http://www.ecy.wa.gov/copyright.html> for copyright notice including permissions, limitation of liability, and disclaimer.

### 4.3.4 SCS Type IA and Type II Standard Design Storms

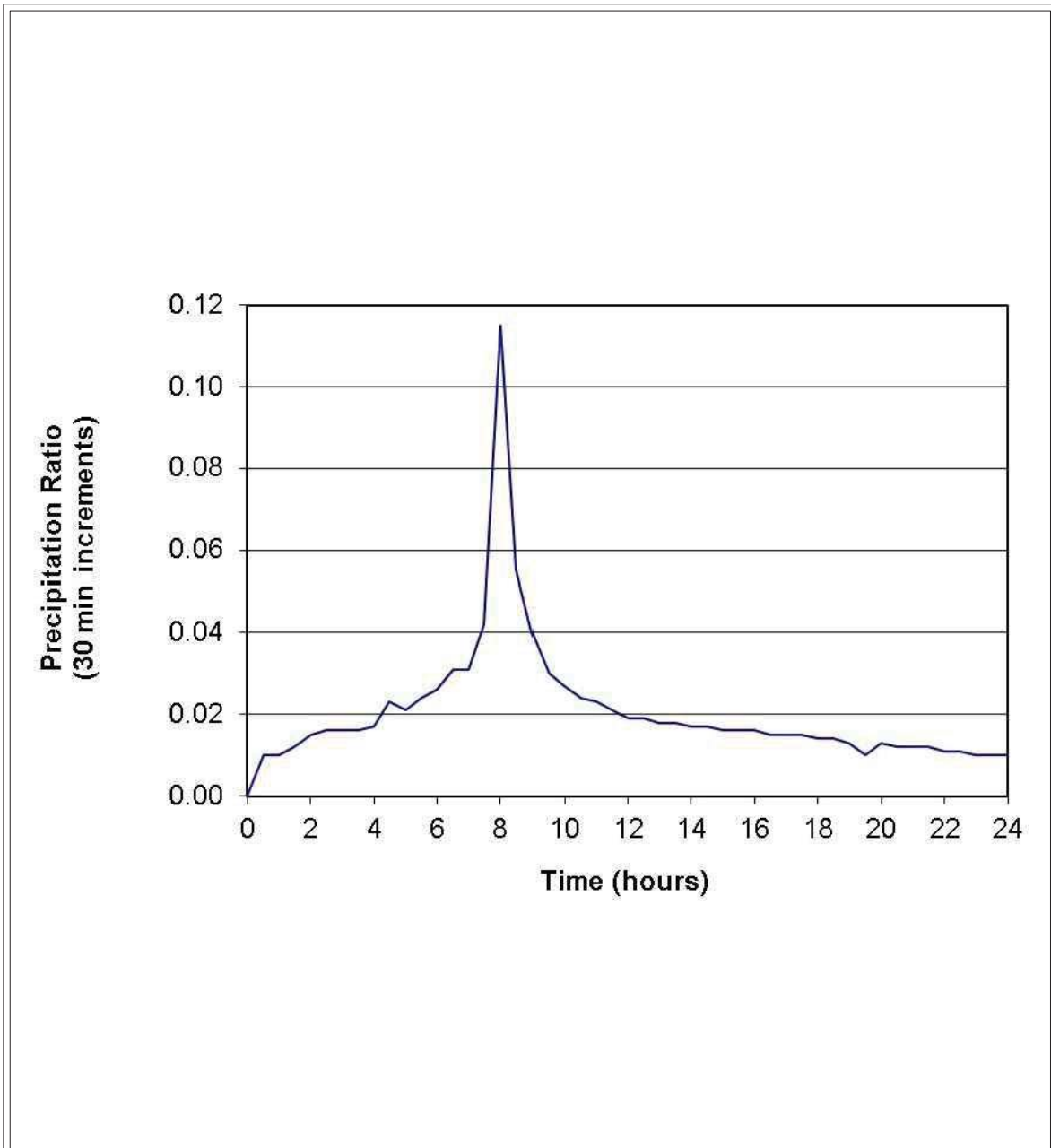
The Soil Conservation Service (SCS) is the former name of the Natural Resources Conservation Service (NRCS).

SCS Type IA and Type II are two of the four standard 24-hour rainfall distributions that are commonly used in the SCS hydrograph method. See [Table 4.3: Comparison of Design Storm Distributions](#) for the advantages and disadvantages and a summary of the situations in which these design storms may be used.

See [Figure 4.4: SCS Type IA Hyetograph](#) and [Figure 4.5: SCS Type II Hyetograph](#) for graphical representations of these two SCS hyetographs. Tabular values of these hyetographs are included in [Table 4.31: SCS Type IA Storm Hyetograph Values](#) and [Table 4.32: SCS Type II Storm Hyetograph Values](#). See [4.A.3 Review of Design Storms and Identification of Best Rainfall-Runoff Modeling Approaches for Eastern Washington](#) for a graphical representation of these two storms and the long-duration storms for comparison on a unit basis.



**Figure 4.4: SCS Type IA Hyetograph**

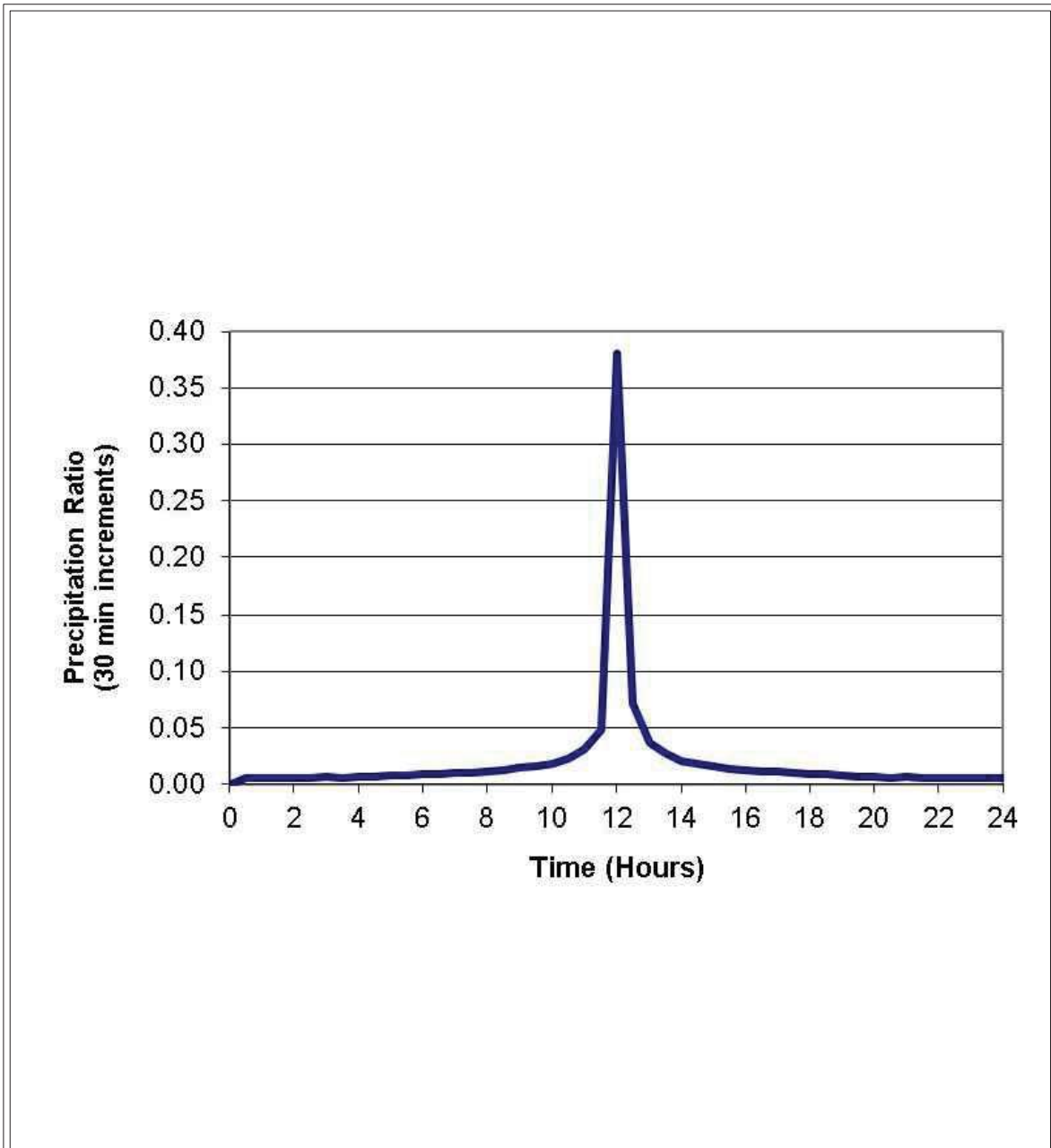


### SCS Type IA Hyetograph

Revised September 2004

Please see <http://www.ecy.wa.gov/copyright.html> for copyright notice including permissions, limitation of liability, and disclaimer.

**Figure 4.5: SCS Type II Hyetograph**



### SCS Type II Hyetograph

Revised September 2004

Please see <http://www.ecy.wa.gov/copyright.html> for copyright notice including permissions, limitation of liability, and disclaimer.

### 4.3.5 Modified SCS Type IA and Regional Design Storms

The modified SCS Type IA design storm is an adapted application of the standard SCS Type IA design storm intended to more closely reflect historical precipitation patterns in eastern Washington. AMC and precipitation depths are modified to reflect more typical conditions. See [Table 4.4: Antecedent Precipitation Prior to Regional Storm](#) for the advantages and disadvantages and a summary of the situations in which these design storms may be used.

If the 24-hour SCS Type IA storm is used directly, the precipitation totals are the 24-hour amounts without adjustment. If the modified Type IA is used, the precipitation totals need to be adjusted as indicated in [4.3.7 Precipitation Magnitude and Frequency for 24-Hour and Regional Storms](#); these adjustment factors are also in the notes in [Table 4.34: Regional Storm Hyetograph Values for Climate Region 1: Cascade Mountains](#) through [Table 4.37: Regional Storm Hyetograph Values for Climate Region 4: Eastern Mountains](#).

The prior soil wetting produced by the previous storm event in the long-duration storm (the portion that is not included in the modeling exercise) still needs to be accounted for by appropriately adjusting the modeling input parameters. Regardless of whether the 24-hour SCS Type IA or regional storm hyetographs are used for modeling, this adjustment must be made. The amount of antecedent precipitation can be expressed as a percentage of the total precipitation modeled, as shown in [Table 4.4: Antecedent Precipitation Prior to Regional Storm](#).

**Table 4.4: Antecedent Precipitation Prior to Regional Storm**

Climate Region Number	Climate Region Name	Antecedent Precipitation as Percentage of 24-Hour SCS Type IA Storm Precipitation
1	East Slope Cascades	33%
2	Central Basin	19%
3	Okanogan, Spokane, Palouse	27%
4	Northeastern & Blue Mountains	36%
Climate Region Number	Climate Region Name	Antecedent Precipitation as Percentage of Regional Long-Duration Storm Hyetograph Precipitation
1	East Slope Cascades	28%
2	Central Basin	19%
3	Okanogan, Spokane, Palouse	25%
4	Northeastern & Blue Mountains	34%

Curve number (CN) adjustments based on engineering analysis and judgment of the antecedent precipitation, soils characteristics, and surface conditions must be considered. The AMC (see [4.6.3 Curve Number](#)) is one basis for adjustment. Another is the use of the SCS county surveys that include estimates of permeability and/or infiltration rates.

**Note:** Precipitation magnitudes and frequencies are adjusted as discussed in [4.3.6 Precipitation Magnitude/Frequency Analysis](#).

### **4.3.6 Precipitation Magnitude/Frequency Analysis**

The current source for precipitation magnitude-frequency estimates is National Oceanic and Atmospheric Administration (NOAA) Atlas 2 ([Miller et al., 1973](#)), which is based on data collected from about 1940 through 1966, and NOAA Technical Report NWS 36 ([NOAA, 1983](#)), which used data through the late 1970s. In both of these studies, precipitation statistics were computed for each gauge and used to produce point precipitation estimates at each site. The accuracy of the estimates was strongly related to the length of record at each site: estimates are generally better for common events than for rare events.

The total depth of rainfall (in tenths of an inch) for storms of 2-, 5-, 10-, 25-, 50-, and 100-year recurrence intervals and 24-hour duration are published by NOAA in the form of isopluvial maps for each state. Isopluvial maps are contour maps where the contours represent total amount of rainfall. The 2-year isopluvial maps for eastern Washington can be found in this section and [4.3.7 Precipitation Magnitude and Frequency for 24-Hour and Regional Storms](#). The remaining isopluvial maps (10-, 25-, 50-, and 100-year) are provided in [4.4 Precipitation Maps](#) for reference. The 24-hour isopluvial maps are used for designs based on the regional storm and 24-hour storms. A 2-year isopluvial map is necessary because a 6-month isopluvial map is not available. The user must scale the 2-year precipitation depth to get a 6-month precipitation depth.

An isopluvial map for the 2-year, 2-hour storm is shown in [Figure 4.6: 2-Year, 2-Hour Isopluvial Map](#). This map is from the Dam Safety Guidelines ([Ecology, 1993](#)). It is used for sizing flow-rate-based treatment BMPs with the short-duration storm.

**Figure 4.6: 2-Year, 2-Hour Isopluvial Map**



**SOURCE:** Dam Safety Guidelines, Technical Note 3, Design Storm Construction, Washington State Department of Ecology, Water Resources Program, report 92-55G April 1993.



## 2-Year, 2-Hour Isopluvial Map

Revised April 2002

Please see <http://www.ecy.wa.gov/copyright.html> for copyright notice including permissions, limitation of liability, and disclaimer.

### 4.3.7 Precipitation Magnitude and Frequency for 24-Hour and Regional Storms

The frequency of the water quality design storm is a 6-month recurrence interval or return period, expected to happen twice per year on the average. NOAA maps were not developed for the 6-month recurrence interval, so a conversion is necessary. Use the following equation to determine the 6-month precipitation from the 2-year, 24-hour precipitation.

#### Equation 4.1: Water Quality Design Storm

$$P_{wqs} = C_{wqs} * P_{2yr24hr}$$

where:

$P_{wqs}$  = 6-month, 24-hour precipitation (inches)

$C_{wqs}$  = coefficient from Table 4.3.4 for converting the 2-year, 24-hour precipitation to the 6-month, 24-hour precipitation

$P_{2yr24hr}$  = 2-year, 24-hour precipitation (inches), from [Figure 4.7: 2-Year, 24-Hour Isopluvial Map](#)

$P_{wqs}$  is used with the regional storm hyetograph or SCS Type IA or Type II hyetographs. [Table 4.5: Values of Coefficient  \$C\_{wqs}\$  for Computing 6-Month, 24-Hour Precipitation](#) lists values of the coefficient  $C_{wqs}$  for the four climate regions. [Table 4.6: Factors for Converting From 24-Hour to Regional Storm Precipitation Depth](#) provides the multipliers for converting the 24-hour precipitation  $P_{wqs}$  to the regional storm precipitation.

**Figure 4.7: 2-Year, 24-Hour Isopluvial Map**



**Table 4.5: Values of Coefficient  $C_{wqs}$  for Computing 6-Month, 24-Hour Precipitation**

Climate Region Number	Climate Region Name	$C_{wqs}$
1	East Slope Cascades	0.70
2	Central Basin	0.66
3	Okanogan, Spokane, Palouse	0.69
4	Northeastern & Blue Mountains	0.70

**Note:** Values of  $C_{wqs}$  are based on the generalized extreme value (GEV) distribution whose distribution parameters can be expressed as a function of mean annual precipitation for eastern Washington.

**Table 4.6: Factors for Converting From 24-Hour to Regional Storm Precipitation Depth**

Climate Region Number	Climate Region Name	Multiplication Factor for Converting From 24-Hour to Regional Storm Precipitation Depth
1	East Slope Cascades	1.16
2	Central Basin	1.00
3	Okanogan, Spokane, Palouse	1.06
4	Northeastern & Blue Mountains	1.07

### 4.3.8 Precipitation Magnitude and Frequency for Short-Duration Storms

Design of flow-rate-based treatment BMPs using the single-event hydrograph method requires a determination of the 6-month, 3-hour precipitation depth for use with the 3-hour short-duration design storm hyetograph. (The updated design storm is indexed to sum to unity at 3 hours, so the 3-hour precipitation depth is needed to scale the hyetograph.) Design of other BMPs or conveyance elements based on the short-duration storm may also require the conversion of the 2-year, 2-hour precipitation to a 3-hour precipitation depth for a different recurrence interval.

The isopluvial map that is used as the starting point for determining the design precipitation depth for a 3-hour short-duration storm is a 2-year, 2-hour precipitation isopluvial map ([Figure 4.6: 2-Year, 2-Hour Isopluvial Map](#)).

The following equation is used to determine 3-hour precipitation for a selected return period:

#### Equation 4.2: Short-Duration Storm



$$P_{sds} = 1.06 * C_{sds} * P_{2yr2hr}$$

where:

$P_{sds}$  = 3-hour precipitation (inches) for a selected return period for the short-duration storm

1.06 = multiplier used for all climate regions to convert x-year, 2-hour precipitation to x-year, 3-hour precipitation

$C_{sds}$  = coefficient (from Table 4.3.6) for converting 2-year, 2-hour precipitation to x-year, 2-hour precipitation depth

$P_{2yr2hr}$  = 2-year, 2-hour precipitation (inches) from [Figure 4.6: 2-Year, 2-Hour Isopluvial Map](#)

[Table 4.7: Values of the Coefficient  \$C\_{sds}\$  for Using 2-Year, 2-Hour Precipitation to Compute 2-Hour Precipitation for Selected Periods of Return](#) lists values of the coefficient  $C_{sds}$  for selected return periods for various magnitudes of mean annual precipitation. An isopluvial map of average annual precipitation is shown in [Figure 4.1: Average Annual Precipitation and Climate Regions](#) and can be used to determine the mean annual precipitation for the site.

**Table 4.7: Values of the Coefficient  $C_{sds}$  for Using 2-Year, 2-Hour Precipitation to Compute 2-Hour Precipitation for Selected Periods of Return**

Climate Region Number	Mean Annual Precipitation (inches)	6-Month	1-Year	10-Year	25-Year	50-Year	100-Year
2	6-8	0.61	0.79	1.63	2.17	2.68	3.29
	8-10	0.62	0.80	1.60	2.09	2.55	3.09
	10-12	0.64	0.81	1.56	2.02	2.44	2.92
2, 3	12-16	0.66	0.82	1.51	1.90	2.26	2.66
3	16-22	0.67	0.83	1.47	1.82	2.13	2.48
1, 4	22-28	0.69	0.84	1.43	1.74	2.01	2.31
	28-40	0.70	0.85	1.40	1.68	1.92	2.19
	40-60	0.72	0.86	1.36	1.61	1.82	2.05
	60-120	0.74	0.87	1.33	1.55	1.74	1.93

### Notes

- The value for 2-hour precipitation is converted to 3-hour precipitation using a multiplier of 1.06 for all recurrence intervals.
- Values of  $C_{sds}$  are based on the generalized extreme value (GEV) distribution whose distribution parameters can be expressed as a function of mean annual precipitation for eastern Washington.

### 4.3.9 Rain-on-Snow and Snowmelt Design

The following information on snow considerations, including rain-on-snow and snowmelt design, is optional guidance for detention and water quality design when required by the local jurisdiction. Other cold weather considerations for BMP design are included in [5.2.4 Cold Weather Considerations](#).

#### Considerations for Snow

In many regions, an inevitable consequence of cold weather is precipitation in the form of snow. [Table 4.8: Average Annual Snowfall at Selected Locations in Eastern Washington](#) illustrates some typical snowfall amounts for eastern Washington as compiled by Desert Research Institute in Nevada. While snowfall amounts are often converted to water equivalents and treated as individual events for the purpose of predicting annual precipitation events, in fact snowfall from multiple events may accumulate over time thus creating storage of potential runoff volumes. This storage may be released gradually over time in the form of snowmelt or it may be converted to runoff rapidly by rain-on-snow events. Gradual melting can cause problems because the runoff may fill or saturate stormwater BMPs prior to an actual design event and consequently produce wet soil conditions and more runoff. Refreezing during cold evenings may exacerbate some of the problems.

**Table 4.8: Average Annual Snowfall at Selected Locations in Eastern Washington**

Location	Period of Record	Average Annual Snowfall (inches)
Asotin 14 SW	1976–2000	14.5
Cle Elum	1931–2000	80.5
Dayton 1 WSW	1931–2000	17.8
Ellensburg	1901–2000	27.7
Ephrata Airport FCWOS	1949–2000	18.3
Goldendale	1931–2000	25.0
Kennewick	1948–2000	6.9
Leavenworth 3 S	1948–2000	95.2
Methow 2 S	1970–2000	38.3
Newport	1927–2000	59.4
Othello 6 ESE	1941–2000	4.2
Prosser 4 NE	1931–2000	7.9
Pullman 2 NW	1940–2000	28.1
Quincy 1 S	1941–2000	13.2
Richland	1948–2000	8.5
Spokane WSO Airport	1889–2000	41.4

**Table 4.8: Average Annual Snowfall at Selected Locations in Eastern Washington (continued)**

Location	Period of Record	Average Annual Snowfall (inches)
Walla Walla FAA Airport	1949–1995	17.4
Wenatchee	1877–2000	27.6
Yakima WSO AP	1946–2000	24.1
Source: Desert Research Institute (Nevada)		

Because of the many physical factors involved, snowmelt is a complicated process, with large annual variations in the melting rate frequently occurring. While the criteria presented here address the effects of rain-on-snow and snowmelt, several simplifying assumptions are made. Where local data or experiences are available, more sophisticated methods should be substituted.

### **Rain-on-Snow Considerations**

For water quality volume, rain-on-snow events can be important in many eastern Washington regions. Although the size of rainfall events typically used in BMP design may or may not produce a significant amount of snowmelt, runoff produced by these events is high because of frozen and saturated ground conditions beneath the snow cover. The actual melting and runoff processes are quite complicated and require information not readily available in most areas. The *Stormwater BMP Design Supplement for Cold Climates* (CWP, 1997) suggested the following four-step simplified procedure. As with other referenced methodology, this approach has not been well tested for eastern Washington, however it does provide a basis for estimating rain-on-snow volumes which could be used and refined with experience.

### **Calculating Rain-on-Snow Volume (Center for Watershed Protection)**

1. Develop a rain-on-snow data set of rainfall events that occurred only for those months when snow is on the ground. Snow events, as well as non-runoff-producing events ( $P < 0.1$  inch), should be excluded from this data set. The result is a recurrence frequency for rain-on-snow events. Because the ground is frozen and/or saturated, this precipitation distribution is also the same as the runoff distribution.
2. Calculate a similar rainfall distribution for months without snow cover.
3. Determine the runoff distribution for months without snow cover. Because we have excluded non-runoff-producing events from the distribution, the runoff is equal to:

### **Equation 4.3: Runoff Distribution for Months without Snow Cover**

$$R = 1.0 * P_{2yr24hr} * (0.05 + 0.9 * I)$$

where:

R = runoff (inches)

$P_{2yr24hr}$  = 2-year, 24-hour precipitation (inches)

I = impervious percentage

If the impervious percentage is known (assume 40%) then, for months without snow:

$$R = 0.41 * P_{2\text{yr}24\text{hr}}$$

A runoff distribution for “summer” is developed by multiplying all of the precipitation values used in Step 2 by the 0.41 multiplier determined previously in this step.

4. Take the “winter” runoff distribution data from Step 1 and combine it with the “summer” runoff distribution computed in Step 3. Sort the data and rank them accordingly to determine an overall annual runoff distribution. Determine the 90th percentile value and use it for design purposes as long as this value is greater than the summer precipitation event.

It should again be pointed out that this methodology does not include any contribution from snowmelt. As previously stated, it is predicated on the assumption that design storm precipitation quantities are not large enough to produce significant melt quantities.

The U.S. Army Corps of Engineers (USACE) developed an expression to estimate the snowmelt as a function of precipitation and rainfall temperature. The equation is:

#### **Equation 4.4: Snowmelt as a Function of Precipitation and Temperature**

$$M_s = 0.00695 * (T_{\text{rain}} - 32) * P_r$$

where:

$M_s$  = snowmelt (inches)

$T_{\text{rain}}$  = rainfall temperature (degrees Fahrenheit)

$P_r$  = precipitation (inches)

This equation predicts that 2.5 inches of rainfall at a rainfall temperature of 50 degrees Fahrenheit (°F) would melt 0.31 inches of snow. Whether this represents a significant increase in required volume would depend on the site.

**Note:** A note concerning the impacts of snowmelt is warranted. Because the ground is generally frozen during snowmelt or rain-on-snow events, the difference between pre- and postproject discharges are often quite small. For this reason, snowmelt and rain-on-snow events rarely need to be considered when designing for channel or overbank protection.

#### **Additional Rain-on-Snow Considerations**

Rain-on-snow could affect the flow in the evaluation of the long-duration storms, especially in regions with high snowfall. Except for higher elevations with deeper snowpacks, it should be assumed that a long-duration design storm results in the complete melting and runoff of the typical snowpack. To determine the typical snowpack, calculate the average daily snow depth from December to February, which is available on the Internet for many eastern Washington locations. If the average daily snow depth is < 1 inch, then the rain-on-snow effect can be considered negligible and should not be considered in the analysis. Assuming 20% moisture content, determine the water

equivalent. A sample of the average daily snow depths and precipitation adjustment amount for selected cities is in [Table 4.9: Snowmelt Adjustment Factors](#).

Snowmelt can also be considered in water quality design. Melting snow from the roadways and from the snow piles alongside the roadways have significant amounts of pollutants generated from the vehicles, deicing chemicals, and roadway salts. The runoff treatment BMPs should be located downstream of the snowmelt areas and can be sized for snowmelt, especially in regions with high snowfall.

**Table 4.9: Snowmelt Adjustment Factors**

Location	Average Daily Snow Depth (inches)	Water Equivalent (inches) 24-Hour Storm Precipitation Adjustment	24-Hour: 72-Hour Precipitation Ratio Based on Climate Region	Regional Storm Precipitation Adjustment (inches)
Colville	5.00	1.0	0.70	0.70
Clarkston	0.33	N/A	N/A	N/A
Goldendale	1.67	0.33	0.67	0.22
Moses Lake	0.67	0.13	0.84	0.11
Omak	4.67	0.93	0.75	0.70
Pullman	1.33	0.27	0.70	0.19
Richland	0.33	N/A	N/A	N/A
Spokane Airport	2.33	0.47	0.75	0.35
Walla Walla	1.00	0.20	0.75	0.15
Wenatchee	2.67	0.53	0.84	0.45
Yakima	2.00	0.40	0.84	0.34

For projects that are located above 2,500 feet elevation, a separate study or local data should be used as the average snow depth is significant and varies widely.

The assumption is that the entire average daily snowmelt on the ground will melt during the long-duration storm. Since the long-duration storm is 72 hours in duration, the water equivalent for the peak 24 hours will be less than if the long-duration storm were only 24 hours. The adjustment factor is the ratio of the 24-hour precipitation to the 72-hour precipitation and varies based on climate region. In order to use the snowmelt factor with the long-duration storm hyetograph, the Long-Duration Storm Precipitation Adjustment should be added to the 24-hour design storm precipitation.

The CN used shall be for normal AMC II.

If the average annual precipitation at the project site varies from the average annual precipitation at the nearest known snow depth record location, the average daily snow depth will also vary. To

determine the estimated average daily snow depth, multiply the known average daily snow depth and all other factors by the ratio of average annual precipitation at the project site to the average annual precipitation at the record location.

An example is a project located in Cashmere where the average annual precipitation is 14 inches. The nearest snow depth record location is Wenatchee. The snow depth at Wenatchee is 2.67 inches from [Table 4.9: Snowmelt Adjustment Factors](#) and the average annual precipitation from [Figure 4.1: Average Annual Precipitation and Climate Regions](#) is 10 inches.

The estimated snow depth for Cashmere is:

$$2.67 * 14/10 = 3.74 \text{ inches}$$

## **Snowmelt**

In relatively dry regions that receive much of their precipitation as snowfall, the sizing is heavily influenced by the snowmelt event. A typical recommendation is to oversize the BMP when average annual snowfall depth is greater than or equal to annual precipitation depth. This assumes snow is approximately 10% water. The sizing criteria for the treatment of water quality are based on the following four assumptions:

- BMPs should be sized to treat the spring snowmelt event.
- Snowmelt runoff is influenced by the moisture content of the spring snowpack and soil moisture.
- No more than 5% of the annual runoff volume should bypass treatment during the spring snowmelt event.
- Because snowmelt occurs over several days, BMPs can treat a snowmelt volume greater than their size would indicate.

Although snowmelt occurs continuously throughout the winter and spring months, the characteristics and rates of runoff may vary. As rules of thumb, one-half of the snowfall is assumed to melt in the winter if the average daily maximum January temperature is < 25°F and two-thirds of the snowfall melts if the temperature is between 25°F and 35°F. Winter melting events have high concentrations of soluble pollutants such as chlorides and metals because of “preferential elution” from the snowpack ([Semkin and Jeffries, 1988](#)). Conversely, spring snowmelt is higher in suspended solids and hydrophobic elements, such as hydrocarbons, which can remain in the snowpack until the last 5% to 10% of water leaves the snowpack ([Marsalek, 1991](#)).

Three methods for estimating snowmelt are available and are described in the following subsections.

### **Snowmelt Method 1 (Stahre and Urbonas)**

Although snowmelt rates can be as high as 0.15 inches/hour (0.151 cubic feet per second [cfs]/acre) under extreme conditions, ([Stahre and Urbonas, 1989](#)) recommended the following minimum design values:

### **Equation 4.5: Snowmelt Method 1**

$$M_s = A_i * 0.04 \text{ cfs/acre} + A_p * 0.02 \text{ cfs/acre}$$

where:

$M_s$  = snowmelt (feet)

$A_i$  = impervious surface area (acres)

$A_p$  = pervious surface area (acres)

### **Snowmelt Method 2 (U.S. Army Corps of Engineers)**

The snowmelt rates from the Stahre and Urbonas method (Snowmelt Method 1) are not universally accepted. ([USACE, 1998](#)) proposed the following temperature index solution for daily snowmelt ( $M_s$ ):

#### **Equation 4.6: Snowmelt Method 2**

$$M_s = C_m * (T_{air} - T_{base})$$

where:

$M_s$  = snowmelt (inches)

$C_m$  = melt-rate coefficient in (inches/°F), which can vary, depending on site conditions. The relative magnitude of this factor is shown in Table 4.3.9.

$T_{air}$  = average daily air temperature (°F)

$T_{base}$  = base temperature (°F); typically around 32°F when using average daily air temperature

**Table 4.10: Melt Rate Coefficients for Various Conditions (Assuming  $T_{base} = 32^\circ\text{F}$ )**

Case	$T_{air}$ (°F)	Melt(inches)	$C_m$ (inches/°F)	Comment
1	70	2.57	0.068	Clear, low albedo
2	70	2.40	0.073	Case 1 with 40% forest
3	65	1.51	0.040	Case 1 with cloud cover
4	70	1.73	0.046	Case 1 with fresh snow
5	50	3.24	0.180	Heavy rain, windy
6	50	2.92	0.163	Light rain, windy
7	50	1.11	0.062	Light rain, light wind

### **Snowmelt Method 3 (Center for Watershed Protection)**

*The Stormwater BMP Design Supplement for Cold Climates* ([CWP, 1997](#)) presents a straight-forward methodology for calculating snowmelt runoff in seven steps. The method is general and a specific application for eastern Washington has not yet been developed. However, it does provide a

basis for estimation which could be used and refined as more knowledge becomes available with experience. The procedure is as follows:

1. The procedure is based on the assumption that oversizing is necessary if the average annual precipitation is less than half the average annual snowfall depth. For example, if the average annual precipitation is 15 inches and the average annual snowfall is  $\geq 16$  inches, oversizing will be required.
2. Determine the annual losses from sublimation and snow removal.
3. Determine the annual water equivalent loss from winter snowmelt events. This requires an assumption regarding the amount of water in an inch of snow.

**Equation 4.7: Snowmelt Method 3**

$$M_s = \{SWE * [S - (L_1 * S)]\} * F_T$$

where:

$M_s$  = snowmelt (inches)

SWE = snow water equivalent (percentage)

S = average annual snowfall (inches)

$L_1$  = water loss to sublimation and snow removal (percentage)

$F_T$  = temperature factor (one-half if the average daily maximum temperature is  $< 25^\circ\text{F}$ ; two-thirds if the temperature is between  $25^\circ\text{F}$  and  $35^\circ\text{F}$ )

For example, assuming that the water equivalence of the snow is 1:10, the average annual snowfall is 40 inches, 15% is lost to the combination of sublimation and snow removal, and the average daily maximum January temperature is  $24^\circ\text{F}$ , the total snowmelt is calculated as:

$$M_s = \{0.1 * [40 - (0.15 * 40)]\} * 0.5 = 1.7 \text{ inches}$$

4. Calculate the snowmelt runoff volume ( $R_s$ ) using:

**Equation 4.8: Snowmelt Runoff Volume (Snowmelt Method 3)**

$$R_s = (1 - I) * [(M_s - \text{Inf}) + (I * M_s)]$$

where:

$R_s$  = snowmelt runoff volume (inches)

I = impervious fraction of the watershed

$M_s$  = snowmelt (inches)

Inf = infiltration (inches)

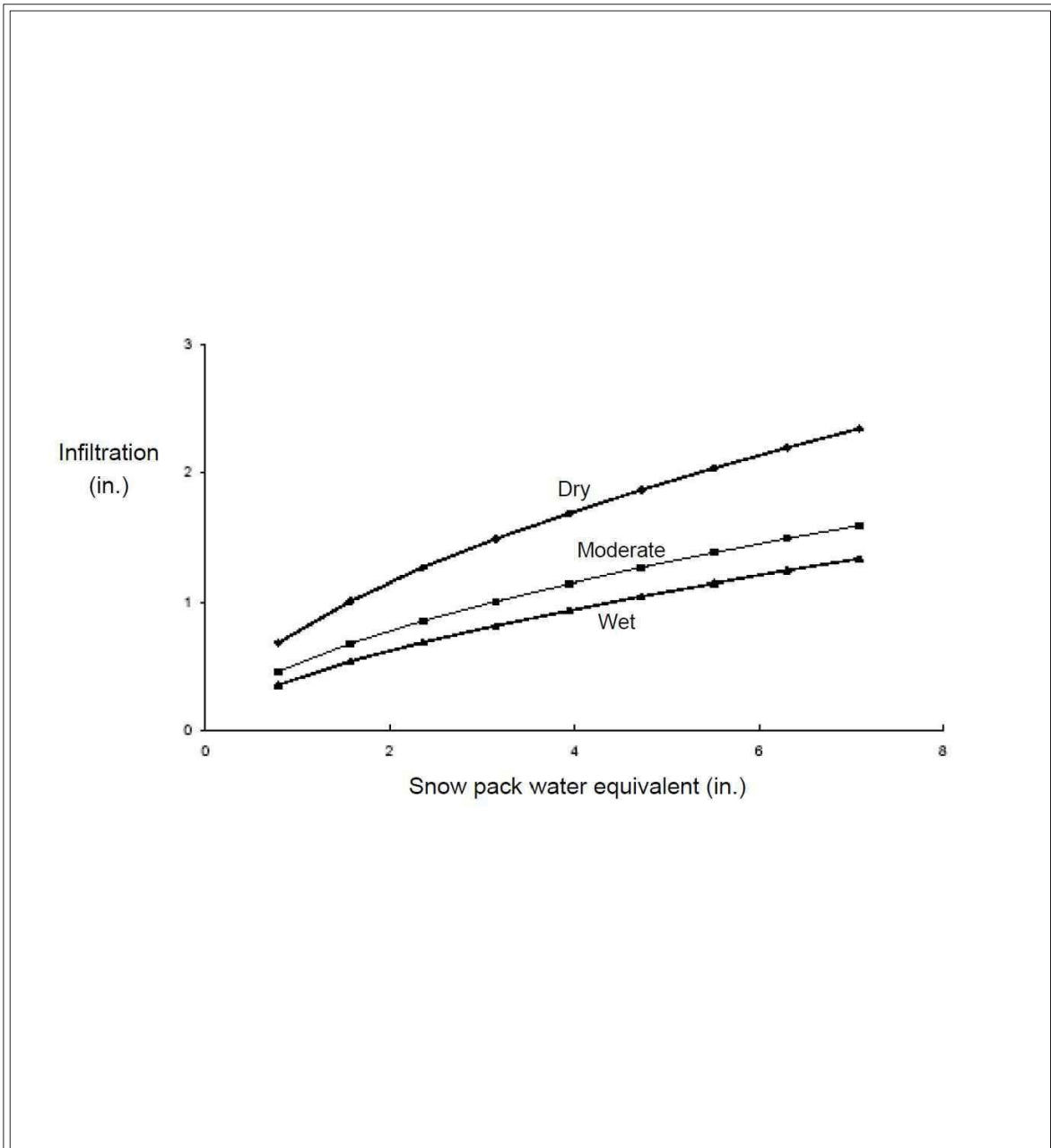
For this example, use Figure 4.3.8 to determine the infiltration amount (0.65 inches) for moderate soil moisture conditions and 1.7 inches of snowpack water. Furthermore, if the



impervious fraction is 0.4, then the snowmelt runoff volume ( $R_s$ ) is calculated as:

$$R_s = (1 - 0.4) * [(1.7 - 0.65) + (0.4 * 1.7)] = 1.31 \text{ inches}$$

**Figure 4.8: Snowmelt Infiltration as a Function of Soil Moisture**



## Snowmelt Infiltration as a Function of Soil Moisture

Revised September 2004

Please see <http://www.ecy.wa.gov/copyright.html> for copyright notice including permissions, limitation of liability, and disclaimer.

- Determine the annual runoff volume. While there are several acceptable ways of computing this value, Schueler (1987) proposed a “Simple Method” whereby annual runoff volume in inches is given by:

**Equation 4.9: Simple Method for Annual Snowmelt Runoff Volume (Snowmelt Method 3)**

$$R_a = 0.9 * P_a * [0.05 + (0.9 * I)]$$

where:

$R_a$  = annual runoff volume (inches)

$P_a$  = annual rainfall (inches)

$I$  = impervious fraction of the watershed

Assuming the annual rainfall volume is 15 inches and the impervious fraction is 0.4, then, for this example:

$$R_a = 0.9 * 15 * [0.05 + (0.9 * 0.4)] = 5.54 \text{ inches}$$

- Determine the runoff volume to be treated ( $V_t$ ) for a 20-acre site.

**Equation 4.10: Runoff Volume Treated (Snowmelt Method 3)**

$$V_t = [R_s - (0.05 * R_a)] * (A/12)$$

where:

$V_t$  = runoff volume to be treated (acre-feet)

$R_s$  = snowmelt runoff volume (inches)

$R_a$  = annual runoff volume (inches)

$A$  = area (acres)

For this example:

$$V_t = [1.31 - (0.05 * 5.54)] * (50/12) = 4.3 \text{ acre-feet}$$

- Because snowmelt occurs over several days or even weeks, the BMP does not have to treat the entire water quality volume over a 24-hour period. A 50% reduction in the volume is used to determine how much storage is required. Thus, the water quality treatment volume is given by:

**Equation 4.11: Water Quality Treatment Volume (Snowmelt Method 3)**

$$WQv = 0.5 * V_t$$

where:

$WQv$  = water quality treatment volume (acre-feet)

$V_t$  = runoff volume to be treated (acre-feet)

For this example:

$$WQv = 0.5 * 4.3 \text{ acre-feet} = 2.15 \text{ acre-feet}$$

Finally, this water quality treatment volume should be compared with the volume from precipitation considerations to determine which is more conservative.

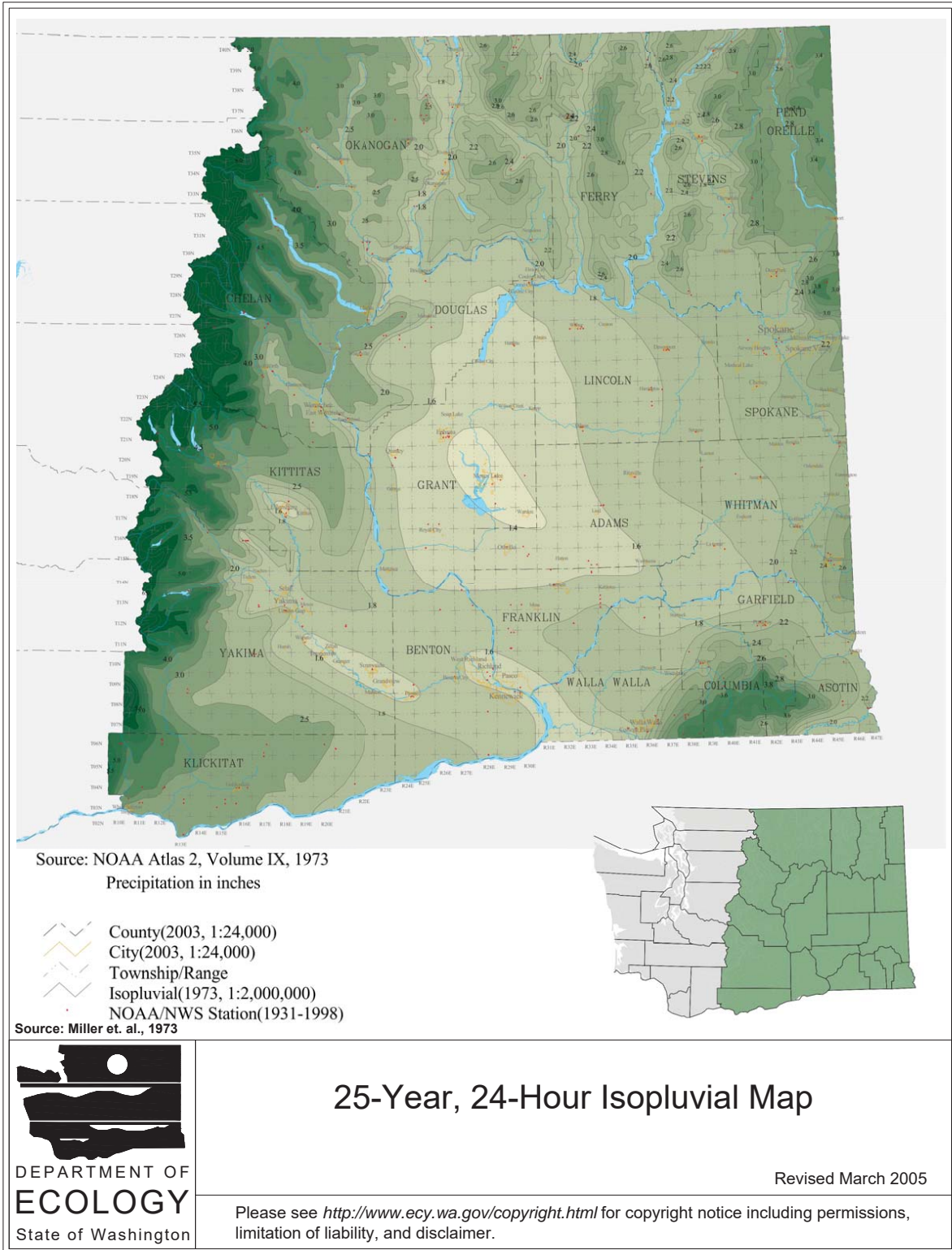
## 4.4 Precipitation Maps

The 2-year isopluvial maps for eastern Washington can be found in [4.3.6 Precipitation Magnitude/Frequency Analysis](#) and [4.3.7 Precipitation Magnitude and Frequency for 24-Hour and Regional Storms](#). The remaining isopluvial maps (10-, 25-, 50-, and 100-year) are provided in [Figure 4.9: 10-Year, 24-Hour Isopluvial Map](#) through [Figure 4.12: 100-Year, 24-Hour Isopluvial Map](#) for reference.

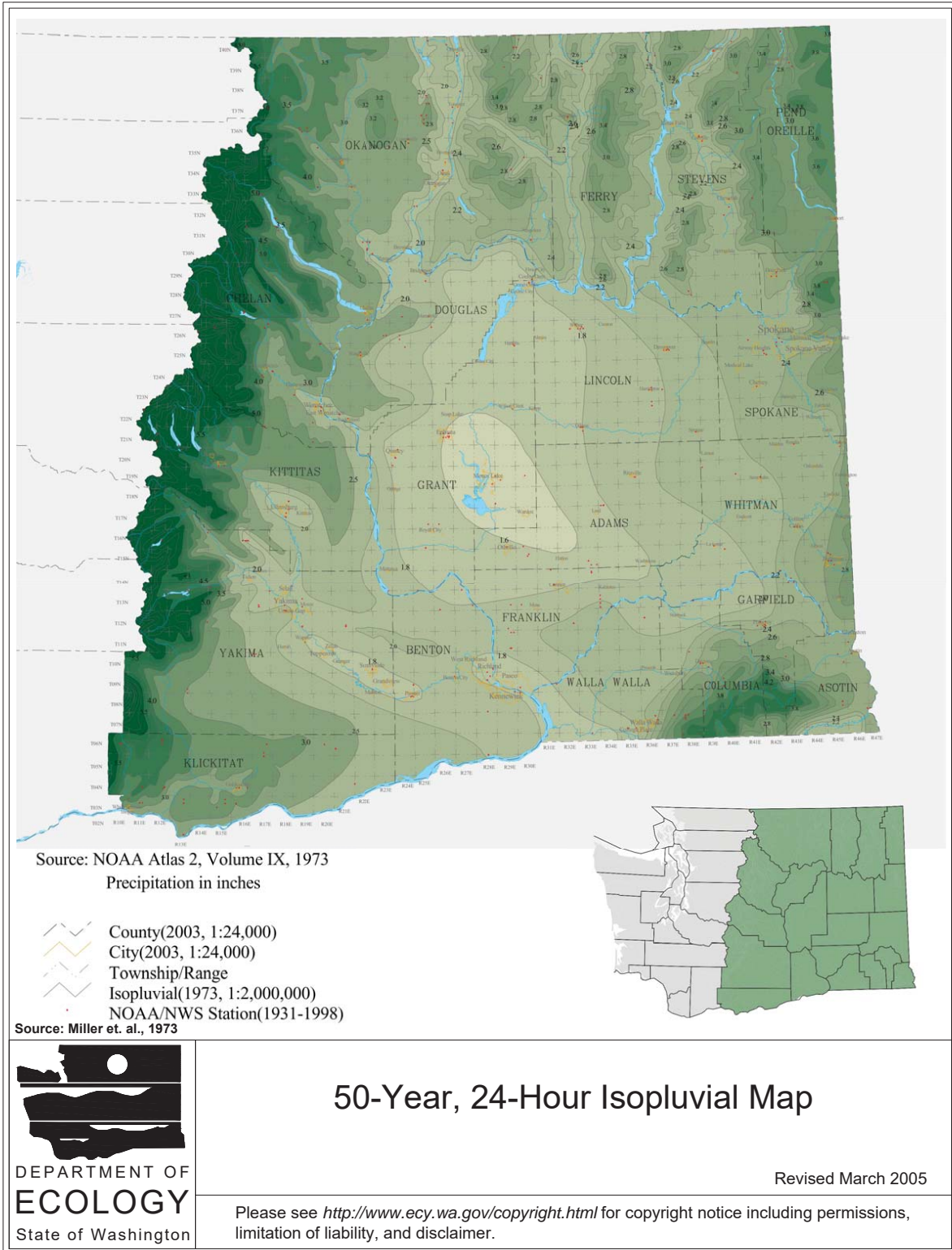
**Figure 4.9: 10-Year, 24-Hour Isopluvial Map**



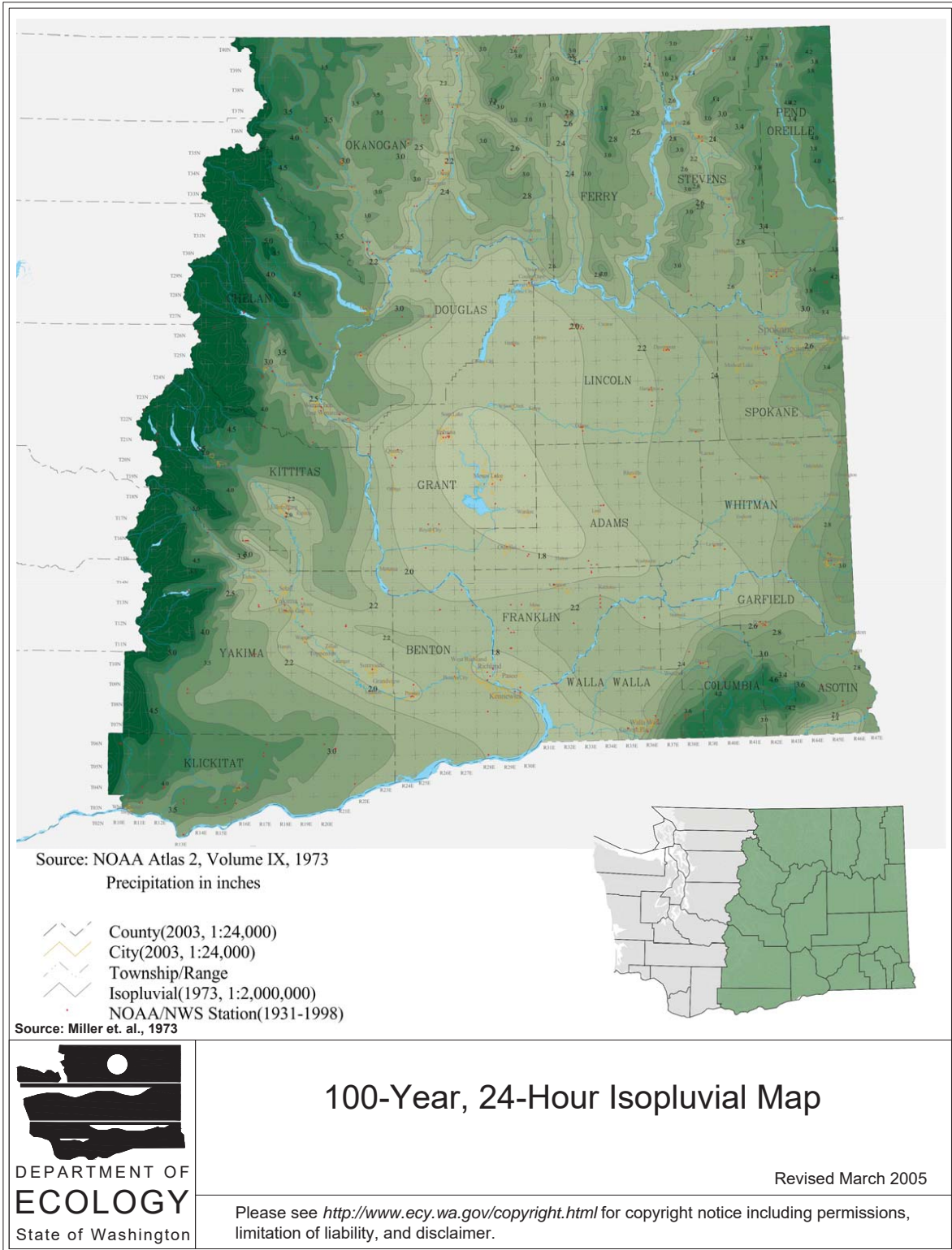
**Figure 4.10: 25-Year, 24-Hour Isopluvial Map**



**Figure 4.11: 50-Year, 24-Hour Isopluvial Map**



**Figure 4.12: 100-Year, 24-Hour Isopluvial Map**





## 4.5 Single-Event Hydrograph Methods

### 4.5.1 Introduction

#### *Applicability*

Single-event hydrograph methods are required for designing flow control Best Management Practices (BMPs). They are an allowable method for computing peak runoff rates and runoff volumes for design of runoff treatment BMPs. Single-event hydrograph methods include the Soil Conservation Service (SCS) hydrograph and the Santa Barbara Urban Hydrograph (SBUH) methods. Commercially available computer programs for these methods may be used if the sponsor's designer acquires acceptance from the local jurisdiction. Such acceptance shall be obtained prior to submittal of plans and calculations.

#### *Supplemental Guidelines*

The SBUH method calculates only flow that will occur from surface runoff and thus is not accurate for large drainage basins where ground water flow can be a major contributor to the total flow. The method is most accurate for drainage basins smaller than 100 acres and should not be used for drainage basins larger than 1,000 acres.

### 4.5.2 Hydrograph Design Process

This section presents the general process involved in conducting a hydrologic analysis using hydrograph methods to:

1. design retention/detention flow control BMPs and
2. determine water quality treatment volumes.

The exact step-by-step method for entering data into a computer model varies with the different models and is not described here. See the documentation or Help module of the computer program. Predevelopment or existing and proposed development site runoff conditions need to be determined and documented in the Stormwater Site Plan.

#### *Process for Designing Retention/Detention Flow Control BMPs*

**For more information:** Review [2.7.7 Core Element #6: Flow Control](#) to determine all flow control requirements that will apply to the proposed project.

The process for designing retention/detention flow control BMPs is described as follows:

1. Identify the climate region and average annual precipitation from [Figure 4.1: Average Annual Precipitation and Climate Regions](#).
2. Identify two precipitation depths from [Figure 4.7: 2-Year, 24-Hour Isopluvial Map](#) and [Figure 4.10: 25-Year, 24-Hour Isopluvial Map](#).
  - 2-year, 24-hour
  - 25-year (or other recurrence interval(s) required by the agency or local jurisdiction), 24-hour

3. Determine the predevelopment or existing and the proposed development drainage basin areas and identify pervious and impervious areas (in acres) for each condition.
4. Determine soil types and hydrologic soil groups (A, B, C, or D) from SCS maps.
5. Determine curve numbers (CNs) for pervious and impervious areas using hydrologic soil groups for both the predevelopment or existing conditions and the proposed development conditions.
6. Determine times of concentration for both predeveloped or existing and proposed development conditions; some computer models will do these calculations if the designer enters length, slope, roughness, and flow type.
7. Select storm hyetograph and analysis time interval; verify that the analysis time interval is appropriate for use with storm hyetograph time increment.
8. Input data obtained from steps 2, 3, 5, 6, and 7 into the computer model for both the predeveloped or existing and the proposed development conditions.
9. Have the computer model compute the hydrographs.
10. Review the peak flow rate for the predeveloped or existing condition in the 2-year and 25-year design storms. The allowable release rate for the entire volume of the 2-year storm is 50% of the predeveloped or existing 2-year peak flow rate. The allowable release rate for the 25-year storm is equal to the predeveloped or existing 25-year peak flow.

**Note:** In some cases the predeveloped or existing 2-year peak flow rate may be 0 cubic feet per second (cfs), which means there is no discharge from the site. In this situation, the 2-year proposed development flow volume must be retained as dead storage that will ultimately infiltrate or evaporate.

11. Review the peak flow rate for the proposed development conditions in the 2-year and 25-year storms. Compare the increases in peak flow rates for 2-year and 25-year design storms to determine if there is an increase in runoff and a flow control BMP is therefore required. Also determine whether the project qualifies for applying dispersion BMPs.
12. Assume a size for the detention BMP and input this size into the computer model. Most computer models will allow a vault or a pond detention BMP, with or without infiltration. See the volume of the design storm hydrograph computed in Step 10 for a reasonable assumption of the detention volume required.
13. Assume a size for the orifice structure and input this size into the computer model. A single orifice at the bottom of the riser may suffice in some cases. In other projects, multiple orifices may result in decreased pond sizes. For a typical pond, a reasonable approximation is 1 inch of diameter orifice per 0.05 cfs outflow. Note that the designer should check with the local jurisdiction to determine the minimum allowable orifice diameter.
14. Use the computer model to route the proposed development hydrographs through the detention BMP and orifice structure. Compare the proposed development peak outflow rates to the allowable release rates identified in Step 11.
15. If the proposed development peak outflow rates exceed the allowable release rates, adjust

the detention volume, orifice size, orifice height, and/or number of orifices. Continue iterations using the computer model and adjusting the parameters until the proposed development outflow rates are less than or equal to the allowable release rates.

16. Calculations are complete.

### ***Process for Identifying Water Quality Treatment Volumes or Flow Rates***

**Note:** The data required for many of the initial steps are data that are used in designing retention/detention flow control BMPs as described above.

The process for identifying water quality treatment volumes or flow rates is described as follows.

1. Review [2.7.6 Core Element #5: Runoff Treatment](#) to determine all runoff treatment requirements that will apply to the proposed project.
2. Determine the climate region and average annual precipitation from [Figure 4.1: Average Annual Precipitation and Climate Regions](#).
3. Determine one of the following precipitation depths (depending on the type of runoff treatment BMP) from [Figure 4.6: 2-Year, 2-Hour Isopluvial Map](#) or [Figure 4.7: 2-Year, 24-Hour Isopluvial Map](#):
  - 2-year, 2-hour for flow-rate-based treatment BMPs
  - 2-year, 24-hour for volume-based treatment BMPs
4. Multiply the rainfall by the appropriate coefficient to convert the 2-year to the 6-month precipitation depth:
  - $1.06 * C_{sds}$  from [Table 4.7: Values of the Coefficient  \$C\_{sds}\$  for Using 2-Year, 2-Hour Precipitation to Compute 2-Hour Precipitation for Selected Periods of Return](#) for 6-month, 3-hour precipitation
  - $C_{wqs}$  from [Table 4.5: Values of Coefficient  \$C\_{wqs}\$  for Computing 6-Month, 24-Hour Precipitation](#) for 6-month, 24-hour precipitation
5. Determine the proposed development drainage basin areas and identify the pervious and impervious areas (in acres) that contribute flow to the treatment BMP.
6. Determine soil types and hydrologic soil groups (A, B, C, or D) from SCS maps.
7. Determine CNs for the pervious and impervious areas using the hydrologic soil group for the proposed development conditions.
8. Determine the time of concentration for the proposed development conditions; some computer models will do this calculation if the designer enters length, slope, roughness, and flow type.
9. If modeling the short- or long-duration storm hyetograph, select the 3-hour short-duration storm hyetographs (see [Table 4.33: Short-Duration Storm Hyetograph Values for All Climate Regions](#)) or regional long-duration storm hyetographs for the climate region (see either [Table 4.31: SCS Type IA Storm Hyetograph Values](#) or [Table 4.34: Regional Storm Hyetograph](#)

[Values for Climate Region 1: Cascade Mountains](#) to [Table 4.37: Regional Storm Hyetograph Values for Climate Region 4: Eastern Mountains](#)) and analysis time interval. Check to be certain that the analysis time interval is appropriate for use with the storm hyetograph time increment.

10. Input data obtained from Steps 4, 5, 7, 8, and 9 into the computer model for the proposed development conditions and storm event.
11. Have the computer model compute the hydrograph.
12. To design flow-rate-based treatment BMPs, use the computed peak flow from the 6-month, 3-hour hydrograph.
13. To design volume-based treatment BMPs, use the computed volume from the 6-month, 24-hour (or long-duration design) hydrograph.

All storm event hydrograph methods require the input of parameters that describe the physical drainage basin characteristics. These parameters provide the basis from which the runoff hydrograph is developed. The following section describes one of the three key parameters used to develop the runoff hydrograph using the SCS hydrograph or SBUH method: time of concentration. The other two parameters are area and CN, which are described in [4.6 SCS Curve Number Equations](#).

### 4.5.3 Travel Time and Time of Concentration

The time of concentration for rainfall shall be computed for all overland flow, ditches, channels, gutters, culverts, and pipe systems. When using the SBUH or SCS hydrograph methods, the time of concentration for the various surfaces and conveyances should be computed using the following methods, which are based on the methods described in *Urban Hydrology for Small Watersheds (USDA, 1986)*.

Travel time is the time it takes water to travel from one location to another in a watershed. Travel time is a component of time of concentration, which is the time for runoff to travel from the hydraulically most distant point of the watershed. Time of concentration is computed by summing all the travel times for consecutive components of the drainage conveyance system. Time of concentration influences the shape and peak of the runoff hydrograph. Urbanization usually decreases time of concentration, thereby increasing the peak discharge. But time of concentration can be increased as a result of:

- a. ponding behind small or inadequate drainage systems, including storm drain inlets and road culverts, or
- b. reduction of land slope through grading.

Water moves through a watershed as sheet flow, shallow concentrated flow, open channel flow, or some combination of these. The type that occurs is best determined by field inspection.

#### ***Travel Time***

Travel time is the ratio of flow length to flow velocity:

#### **Equation 4.12: Travel Time**

$$T_t = L / 60 * V$$

where:

$T_t$  = travel time (minutes)

L = flow length (feet)

V = average velocity (feet per second [ft/sec])

60 = unit conversion factor from seconds to minutes

### **Time of Concentration**

Time of concentration is the sum of travel time values for the various consecutive flow segments.

#### **Equation 4.13: Time of Concentration**

$$T_c = T_{t1} + T_{t2} + \dots + T_{tm}$$

where:

$T_c$  = time of concentration (minutes)

m = number of flow segments

### **Sheet Flow**

Sheet flow is flow over plane surfaces. It usually occurs in the headwater of streams. With sheet flow, the friction value ( $n_s$ ) (a modified Manning's effective roughness coefficient that includes the effect of raindrop impact; drag over the plane surface; obstacles such as litter, crop ridges, and rocks; and erosion and transportation of sediment) is used. These  $n_s$  values are for very shallow flow depths of about 0.1 foot and are only used for travel lengths up to 300 feet. [Table 4.11: Values of n and k for Use in Computing Time of Concentration](#) gives Manning's n. values for sheet flow for various surface conditions.

For sheet flow up to 300 feet, use Manning's kinematic solution to directly compute  $T_t$ :

#### **Equation 4.14: Sheet Flow Travel Time**

$$T_t = 0.42 * (n_s * L)^{0.8} / [(P_{2yr2hr})^{0.5} * (s_o)^{0.4}]$$

where:

$T_t$  = travel time (minutes)

$n_s$  = sheet flow Manning's effective roughness coefficient from [Table 4.11: Values of n and k for Use in Computing Time of Concentration](#)

L = flow length (feet)

$P_{2yr2hr}$  = 2-year, 24-hour rainfall from [Figure 4.7: 2-Year, 24-Hour Isopluvial Map](#) (inches) ( $P_{2yr2hr}$  may be called  $P_2$  in other forms of this equation)

$s_o$  = slope of hydraulic grade line or land slope (feet per foot [ft/ft])

## Shallow Concentrated Flow

After a maximum of 300 feet, sheet flow is assumed to become shallow concentrated flow. The average velocity for this flow can be calculated using the  $k_s$  values from [Table 4.11: Values of n and k for Use in Computing Time of Concentration](#) in which average velocity is a function of slope and channel type of the receiving water. After computing the average velocity using the Velocity Equation ([Equation 4.15: Velocity Equation](#)), the travel time for the shallow concentrated flow segment can be computed using the Travel Time Equation ([Equation 4.12: Travel Time](#)).

### Velocity Equation

A commonly used method of computing average velocity of flow, once it has measurable depth, is the following equation:

#### Equation 4.15: Velocity Equation

$$V = k * \sqrt{s_o}$$

where:

V = velocity (ft/sec)

k = time of concentration velocity factor (ft/sec)

$s_o$  = slope of flow path (ft/ft)

k values in [Table 4.11: Values of n and k for Use in Computing Time of Concentration](#) have been computed for various land covers and channel characteristics with assumptions made for hydraulic radius using the following rearrangement of Manning's equation:

#### Equation 4.16: Time of Concentration Velocity Factor

$$k = (1.49 * R^{0.667})/n$$

where:

R = assumed hydraulic radius

n = Manning's roughness coefficient for open channel flow, from [Table 4.11: Values of n and k for Use in Computing Time of Concentration](#) or [Table 4.12: Other Values of the Roughness Coefficient n for Channel Flow](#)

## Open Channel Flow

Open channels are assumed to begin where surveyed cross-sectional information has been obtained, where channels are visible on aerial photographs, or where lines indicating streams appear (in blue) on U.S. Geological Survey (USGS) quadrangle sheets. The  $k_c$  values from [Table 4.11: Values of n and k for Use in Computing Time of Concentration](#) used in the Velocity Equation ([Equation 4.15: Velocity Equation](#)) or water surface profile information can be used to estimate average flow velocity. Average flow velocity is usually determined for bankfull conditions. After average velocity is computed the travel time for the channel segment can be computed using the Travel Time Equation ([Equation 4.12: Travel Time](#)).

## Lakes or Wetlands

Sometimes it is necessary to estimate the velocity of flow through a lake or wetland at the outlet of a watershed. This travel time is normally very small and can be assumed as zero. Where significant attenuation may occur due to storage effects, the flows should be routed using the level-pool routing method described in [4.7 Level-Pool Routing Method](#).

### Limitations:

The following limitations apply in estimating travel time.

- Manning's kinematic solution should not be used for sheet flow > 300 feet.
- In watersheds with drainage systems, carefully identify the appropriate hydraulic flow path to estimate time of concentration. Drainage systems generally handle only a small portion of a large event. The rest of the peak flow travels by streets, lawns, and so on, to the outlet. Consult a standard hydraulics textbook to determine average velocity in pipes for either pressure or nonpressure flow.
- A culvert or bridge can act as a reservoir outlet if there is significant storage behind it. A hydrograph should be developed to this point and the level-pool routing technique should be used to determine the outflow rating curve through the culvert or bridge.

**Table 4.11: Values of  $n$  and  $k$  for Use in Computing Time of Concentration**

Sheet Flow	$n_s$
Smooth surfaces (concrete, asphalt, gravel, or bare hard soil)	0.011
Fallow fields of loose soil surface (no vegetal residue)	0.05
Cultivated soil with crop residue (slope < 0.20 ft/ft)	0.06
Cultivated soil with crop residue (slope > 0.20 ft/ft)	0.17
Short prairie grass and lawns	0.15
Dense grass	0.24
Bermuda grass	0.41
Range, natural	0.13
Woods or forest, poor cover	0.40
Woods or forest, good cover	0.80
Shallow, Concentrated Flow	$k_s$
Forest with heavy ground litter and meadows ( $n = 0.10$ )	3
Brushy ground with some trees ( $n = 0.06$ )	5
Fallow or minimum tillage cultivation ( $n = 0.04$ )	8
High grass ( $n = 0.035$ )	9

**Table 4.11: Values of  $n$  and  $k$  for Use in Computing Time of Concentration (continued)**

Short grass, pasture and lawns ( $n = 0.030$ )	11
Newly bare ground ( $n = 0.025$ )	13
Paved and gravel areas ( $n = 0.012$ )	27
<b>Channel Flow (Intermittent, <math>R = 0.2</math>)</b>	<b><math>k_c</math></b>
Forested swale with heavy ground litter ( $n = 0.10$ )	5
Forested drainage course/ravine with defined channel bed ( $n = 0.050$ )	10
Rock-lined waterway ( $n = 0.035$ )	15
Grassed waterway ( $n = 0.030$ )	17
Earth-lined waterway ( $n = 0.025$ )	20
CMP pipe ( $n = 0.024$ )	21
Concrete pipe ( $n = 0.012$ )	42
Other waterways and pipes	$0.508/n$
<b>Channel Flow (Continuous Stream, <math>R = 0.4</math>)</b>	<b><math>k_c</math></b>
Meandering stream with some pools ( $n = 0.040$ )	20
Rock-lined stream ( $n = 0.035$ )	23
Grassed stream ( $n = 0.030$ )	27
Other streams, man-made channels and pipe	$0.807/n$

**Table 4.12: Other Values of the Roughness Coefficient  $n$  for Channel Flow**

Type of Channel and Description	Manning's $n^a$
<b>A. Constructed Channels</b>	
<b>a. Earth, straight and uniform</b>	
1. Clean, recently completed	0.018
2. Gravel, uniform selection, clean	0.025
3. With short grass, few weeds	0.027
<b>b. Earth, winding and sluggish</b>	
1. No vegetation	0.025
2. Grass, some weeds	0.030
3. Dense weeds or aquatic plants in deep channels	0.035



**Table 4.12: Other Values of the Roughness Coefficient  $n$  for Channel Flow (continued)**

Type of Channel and Description	Manning's $n^a$
4. Earth bottom and rubble sides	0.030
5. Stony bottom and weedy banks	0.035
6. Cobble bottom and clean sides	0.040
<b>c. Rock lined</b>	
1. Smooth and uniform	0.035
2. Jagged and irregular	0.040
<b>d. Channels not maintained, weeds and brush uncut</b>	
1. Dense weeds, high as flow	0.080
2. Clean bottom, brush on sides	0.050
3. Same, highest stage of flow	0.070
4. Dense brush, high stage	0.100
<b>B. Natural Streams</b>	
<b><i>B-1 Minor streams (top width at flood stage &lt; 100 ft.)</i></b>	
<b>a. Streams on plain</b>	
1. Clean, straight, full stage no rifts or deep pools	0.030
2. Same as 1, but more stones and weeds	0.035
3. Clean, winding, some pools and shoals	0.040
4. Same as 3, but some weeds	0.040
5. Same as 4, but more stones	0.050
6. Sluggish reaches, weedy deep pools	0.070
7. Very weedy reaches, deep pools, or floodways with heavy stand of timber and underbrush	0.100
<b>b. Mountain streams, no vegetation in channel, banks usually steep, trees and brush along banks submerged at high stages</b>	
1. Bottom: gravel, cobbles and few boulders	0.040
2. Bottom: cobbles with large boulders	0.050
<b><i>B-2 Floodplains</i></b>	
<b>a. Pasture, no brush</b>	
1. Short grass	0.030
2. High grass	0.035
<b>b. Cultivated areas</b>	

**Table 4.12: Other Values of the Roughness Coefficient  $n$  for Channel Flow (continued)**

Type of Channel and Description	Manning's $n^a$
1. No crop	0.030
2. Mature row crops	0.035
3. Mature field crops	0.040
<b>c. Brush</b>	
1. Scattered brush, heavy weeds	0.050
2. Light brush and trees	0.060
3. Medium to dense brush	0.070
4. Heavy, dense brush	0.100
<b>d. Trees</b>	
1. Dense willows, straight	0.150
2. Cleared land with tree stumps, no sprouts	0.040
3. Same as 2, but with heavy growth of sprouts	0.060
4. Heavy stand of timber, a few down trees, little undergrowth, flood stage below branches	0.100
5. Same as 4, but with flood stage reaching branches	0.120
<sup>a</sup> These $n$ values are "normal" values for use in analysis of channels. For conservative design for channel capacity the "maximum" values listed in other references should be considered. For channel bank stability the minimum values should be considered.	

**Example**

The following is an example of travel time and time of concentration calculations.

**Given:** An existing drainage basin having a selected flow route composed of the following four segments.

Note: Drainage basin has a  $P_2 = 0.8$  inches.

<b>Segment 1:</b>	L = 200 ft, Forest with good cover (sheet flow) $s_o = 0.03$ ft/ft, $n_s = 0.80$
<b>Segment 2:</b>	L = 300 ft, Pasture (shallow concentrated flow) $s_o = 0.04$ ft/ft, $k_s = 11$
<b>Segment 3:</b>	L = 300 ft, Grass-lined waterway (intermittent channel) $s_o = 0.05$ , $k_c = 17$
<b>Segment 4:</b>	L = 500 ft, Grass-lined stream (continuous) $s_o = 0.02$ , $k_c = 27$

Calculate travel times ( $T_t$ ) for each reach and then sum them to calculate the drainage basin time of concentration ( $T_c$ ).

- **Segment 1:** Sheet flow, ( $L < 300$  feet)

Use [Equation 4.14: Sheet Flow Travel Time](#):

$$T_1 = \frac{0.42 * (0.8 * 200)^{0.8}}{0.8^{0.3} * 0.03^{0.4}} = 106 \text{ minutes}$$

- **Segment 2:** Shallow concentrated flow

Use [Equation 4.15: Velocity Equation](#):

$$V_2 = 11 * \sqrt{0.04} = 2.2 \text{ ft/sec}$$

$$T_2 = \frac{L}{60 * V} = \frac{300}{60 * 2.2} = 2 \text{ minutes}$$

- **Segment 3:** Intermittent channel flow

Use [Equation 4.15: Velocity Equation](#):

$$V_3 = 17 * \sqrt{0.05} = 3.8 \text{ ft/sec}$$

$$T_3 = \frac{300}{60 * 3.8} = 1 \text{ minute}$$

- **Segment 4:** Continuous stream

Use [Equation 4.15: Velocity Equation](#):

$$V_4 = 27 * \sqrt{0.02} = 3.8 \text{ ft/sec}$$

$$T_4 = \frac{500}{60 * 3.8} = 2 \text{ minutes}$$

Use [Equation 4.13: Time of Concentration](#):

$$T_c = T_1 + T_2 + T_3 + T_4 = 106 + 2 + 1 + 2 = 111 \text{ minutes}$$

It is important to note how the initial sheet flow segment's travel time dominates the time of concentration computation. This will nearly always be the case for relatively small drainage basins and in particular for the existing site conditions. This also illustrates the significant impact urbanization has on the surface runoff portion of the hydrologic process.

The time of concentration should be calculated for each significantly different slope. Travel time for flow in pipes, ditches and gutters should be computed as a function of the velocity as defined by the Manning formula.

#### 4.5.4 Hydrograph Synthesis

This section presents a description of the SBUH method. This method is used to synthesize the runoff hydrograph from precipitation excess (time distribution of runoff) and time of concentration.

The SBUH method was developed by the Santa Barbara County Flood Control and Water Conservation District, California. The SBUH method directly computes a runoff hydrograph without going through an intermediate process (unit hydrograph) as the SCS hydrograph method does. By comparison, the calculation steps of the SBUH method are much simpler and can be programmed on a calculator or a spreadsheet program. Commercial software is also available that can perform these calculations.

The SBUH method uses two steps to synthesize the runoff hydrograph:

1. Compute the instantaneous hydrograph
2. Compute the runoff hydrograph

#### *Instantaneous Hydrograph*

The instantaneous hydrograph is computed as follows:

#### **Equation 4.17: Instantaneous Hydrograph**

$$I(t) = [60.5 * R(t) * A] / dt$$

where:

$I(t)$  = instantaneous hydrograph at each time interval  $dt$  (cfs)

$R(t)$  = total runoff depth from both impervious and pervious runoff at time interval  $dt$  (inches). Also known as precipitation excess.

$A$  = area (acres)

$dt$  = time interval (minutes)

A maximum time interval of 5 minutes is used for all short-duration design storms. A maximum time interval of 30 minutes is used for all regional design storms.

## Runoff Hydrograph

The runoff hydrograph is then obtained by routing the instantaneous hydrograph through an imaginary reservoir with a time delay equal to the time of concentration of the drainage basin. The following equation estimates the routed flow:

### Equation 4.18: Runoff Hydrograph

$$Q(t+1) = Q(t) + w * [I(t) + I(t+1) - 2 * Q(t)]$$

### Equation 4.19: Routing Constant

$$w = dt / (2 * T_c + dt)$$

where:

$Q(t)$  = runoff hydrograph or routed flow (cfs)

$I(t)$  = instantaneous hydrograph at each time interval  $dt$  (cfs)

$w$  = routing constant

$dt$  = time interval (minutes)

$T_c$  = time of concentration (minutes)

## Example

To illustrate the SBUH method, [Appendix 4-E: Example SBUH Runoff Hydrograph](#) includes a runoff hydrograph computed by this method. These examples were prepared using spreadsheet program. These examples illustrate how the method can be performed with a personal computer. In order to save space, time increments with all values equal to zero have been omitted.

## 4.6 SCS Curve Number Equations

### 4.6.1 Introduction

#### Applicability

The Soil Conservation Service (SCS) curve number equations are an allowable method for computing storage volumes for volume-based treatment Best Management Practices (BMPs) based on the SCS hydrograph method. SCS curve numbers (CNs) are also used in the single-event hydrograph methods such as the SCS hydrograph and the Santa Barbara Urban Hydrograph (SBUH) methods.

This method can be used to size the volume of treatment BMPs when the design is based on the volume of runoff. Computer models are not required for this method. Required input consists of precipitation, pervious and impervious area and CNs.

### 4.6.2 Area

Drainage subbasin areas should be delineated in a manner that runoff characteristics are as homogeneous as practicable and in reasonable configurations. Subbasin configurations should be

contiguous and consistent with surface runoff patterns. See [4.6.3 Curve Number](#) for discussion regarding when weighted averaging is appropriate and not appropriate.

### **4.6.3 Curve Number**

The Natural Resources Conservation Service (NRCS, formerly the Soil Conservation Service) has for many years conducted studies into the runoff characteristics of various land types. After gathering and analyzing extensive data, the NRCS has developed relationships between land use, soil type, vegetation cover, interception, infiltration, surface storage, and runoff. These relationships have been characterized by a single runoff coefficient called a *curve number* (CN). The *National Engineering Handbook* ([USDA, 2004](#)) contains a detailed description of the development and use of the SCS curve number equations.

NRCS has developed CN values based on soil type and land use. The combination of soil type and land use is called the “soil-cover complex.” The soil-cover complexes have been assigned to one of four hydrologic soil groups, according to their runoff characteristics (see descriptions in the Hydrologic Soil Group Classifications section). SCS has classified over 4,000 soil types into these four soil groups.

[Table 4.13: Hydrologic Soil Series for Selected Soils in Eastern Washington](#) shows the hydrologic soil group of some of the common soil types in eastern Washington. For details of the hydrologic soil group for other soil types, see the SCS maps published for each county.

**Table 4.13: Hydrologic Soil Series for Selected Soils in Eastern Washington**

Soil Type	Hydrologic Soil Group	Soil Type	Hydrologic Soil Group
Athena	B	Laketon	C
Bernhill	B	Lance	B
Bong	A	Larkin	B
Bonner	B	Latah	D
Brickel	C	Marble	A
Bridgeson	D	Mondovi	B
Caldwell	C	Moscow	C
Cedonia	B	Naff	B
Cheney	B	Narcisse	C
Clayton	B	Nez Perce	C
Cocolalla	D	Palouse	B
Dearyton	C	Peone	D
Dragoon	C	Phoebe	B
Eloika	B	Reardan	C
Emdent	D	Schumacher	B
Freeman	C	Semiahmoo	D
Garfield	C	Snow	B
Garrison	B	Speigle	B
Glenrose	B	Spokane	C
Green Bluff	B	Springdale	A
Hagen	B	Tekoa	C
Hardesty	B	Uhlig	B
Hesseltine	B	Vassar	B
Konner	D	Wethey	C
Lakesol	B	Wolfeson	C

Source: [\(USDA, 1986\)](#)

**For more information:** See SCS maps for additional soil types and hydrologic soil groups.

## ***Hydrologic Soil Group Classifications***

NRCS has classified soils into the following hydrologic soil groups:

- A. Low runoff potential: Soils having high infiltration rates, even when thoroughly wetted, and consisting chiefly of deep, well-drained to excessively drained sands or gravels. These soils have a high rate of water transmission.
- B. Moderately low runoff potential: Soils having moderate infiltration rates when thoroughly wetted, and consisting chiefly of moderately fine to moderately coarse textures. These soils have a moderate rate of water transmission.
- C. Moderately high runoff potential: Soils have slow infiltration rates when thoroughly wetted, and consisting chiefly of soils with a layer that impedes downward movement of water, or soils with moderately fine to fine textures. These soils have a slow rate of water transmission.
- D. High runoff potential: Soils having very slow infiltration rates when thoroughly wetted, and consisting chiefly of clay soils with a high swelling potential, soils with a permanent high water table, soils with a hardpan or clay layer at or near the surface, and shallow soils over nearly impervious material. These soils have a very slow rate of water transmission.

The following are important criteria/considerations for selection of CN values.

Many factors may affect the CN value for a given land use. For example, the movement of heavy equipment over bare ground may compact the soil so that it has a lesser infiltration rate and greater runoff potential than would be indicated by strict application of the CN value based on predevelopment conditions at the site.

Separate CN values must be selected for the pervious and impervious areas of an urban basin or subbasin. For all developed areas, the impervious percentage must be estimated from best available plans, topography, or aerial photography and verified by field reconnaissance. Generally, the pervious area CN value shall be a weighted average of all the pervious area CN values within the subbasin. However, if two large homogeneous areas (such as a parking lot and a park) within the same subbasin have CN values which differ by more than 20 points, separate hydrographs need to be generated for the two areas and the hydrographs then summed. See the example provided later in this section.

Directly connected impervious areas are areas such as roofs and driveways from which runoff directly enters the drainage system without first traversing an area of pervious ground. Unconnected impervious areas are areas whose runoff is spread over a pervious area as sheet flow and include such items as a tennis court in the middle of a lawn. Unconnected impervious areas can be weighted with pervious areas.

[Table 4.14: Runoff Curve Numbers \(CNs\) for Selected Agricultural, Suburban, and Urban Areas](#) gives CN values for agricultural, suburban, and urban land use classifications. The CN values listed in [Table 4.14: Runoff Curve Numbers \(CNs\) for Selected Agricultural, Suburban, and Urban Areas](#) are applicable under a normal antecedent moisture condition (AMC II) and are the basis of design in eastern Washington.



High ground water or shallow bedrock can cause a significant increase in runoff. If either of these conditions exists, it needs to be addressed by the designer. For a more complete discussion of computing weighted CN values, see *Urban Hydrology for Small Watersheds* ([USDA, 1986](#)).

**Table 4.14: Runoff Curve Numbers (CNs) for Selected Agricultural, Suburban, and Urban Areas**

Cover type and hydrologic condition	CNs for hydrologic soil group			
	A	B	C	D
<b>Open space (lawns, parks, golf courses, cemeteries, landscaping, etc.)<sup>a</sup></b>				
Poor condition (grass cover <50% of the area)	68	79	86	89
Fair condition (grass cover on 50% to 75% of the area)	49	69	79	84
Good condition (grass cover on >75% of the area)	39	61	74	80
<b>Impervious areas</b>				
Open water bodies: lakes, wetlands, ponds etc.	100	100	100	100
Paved parking lots, roofs, driveways, etc. (excluding right-of-way)	98	98	98	98
<b>Permeable pavers and permeable interlocking concrete (assumed as 85% impervious and 15% lawn)</b>				
Fair lawn condition (weighted average CNs)	95	96	97	97
Gravel (including right-of-way)	76	85	89	91
Dirt (including right-of-way)	72	82	87	89
<b>Pasture, grassland, or range-continuous forage for grazing</b>				
Poor condition (ground cover <50% or heavily grazed with no mulch)	68	79	86	89
Fair condition (ground cover 50% to 75% and not heavily grazed)	49	69	79	84
Good condition (ground cover >75% and lightly or only occasionally grazed)	39	61	74	80
<b>Cultivated agricultural lands</b>				
Row Crops (good) e.g., corn, sugar beets, soy beans	64	75	82	85
Small Grain (good) e.g., wheat, barley, flax	60	72	80	84
<b>Meadow</b>				
Continuous grass, protected from grazing and generally mowed for hay	30	58	71	78
<b>Brush (brush-weed-grass mixture with brush the major element)</b>				

**Table 4.14: Runoff Curve Numbers (CNs) for Selected Agricultural, Suburban, and Urban Areas (continued)**

Cover type and hydrologic condition	CNs for hydrologic soil group			
	A	B	C	D
Poor (<50% ground cover)	48	67	77	83
Fair (50% to 75% ground cover)	35	56	70	77
Good (>75% ground cover)	30 <sup>b</sup>	48	65	73
<b>Woods-grass combination (orchard or tree farm)<sup>c</sup></b>				
Poor	57	73	82	86
Fair	43	65	76	82
Good	32	58	72	79
<b>Woods</b>				
Poor (Forest litter, small trees, and brush destroyed by heavy grazing or regular burning)	45	66	77	83
Fair (Woods are grazed but not burned, and some forest litter covers the soil)	36	60	73	79
Good (Woods are protected from grazing, and litter and brush adequately cover the soil)	30	55	70	77
<b>Herbaceous (mixture of grass, weeds, and low-growing brush, with brush the minor element)</b>				
Poor (<30% ground cover)	n/a <sup>d</sup>	80	87	93
Fair (30% to 70% ground cover)		71	81	89
Good (>70% ground cover)		62	74	85
<b>Sagebrush with grass understory</b>				
Poor (<30% ground cover)	n/a <sup>d</sup>	67	80	85
Fair (30% to 70% ground cover)		51	63	70
Good (>70% ground cover)		35	47	55
<sup>a</sup> Composite CNs may be computed for other combinations of open space cover type. <sup>b</sup> Actual CN is < 30; use CN = 30 for runoff computations. <sup>c</sup> The indicated CNs were computed for areas with 50% woods and 50% grass (pasture) cover. Other combinations of conditions may be computed from the CNs for woods and pasture. <sup>d</sup> CNs have not been developed for hydrologic soil group A.				

**For more information:** For a more detailed and complete description of land use curve numbers (CNs), see *Urban Hydrology for Small Watersheds* ([USDA, 1986](#)).

### Antecedent Moisture Condition

The moisture condition in a soil at the onset of a storm event, referred to as the antecedent moisture condition (AMC), has a significant effect on both the volume and rate of runoff. Recognizing that fact, the SCS developed three antecedent soil moisture conditions (I, II, and III), which are described as follows:

- **AMC I:** Soils are dry but not to wilting point.
- **AMC II:** Average conditions.
- **AMC III:** Heavy rainfall, or light rainfall and low temperatures have occurred within the last 5 days; near saturated or saturated soil.

[Table 4.15: Total 5-Day Antecedent Rainfall](#) gives seasonal rainfall limits for the three antecedent soil moisture conditions.

**Table 4.15: Total 5-Day Antecedent Rainfall**

Antecedent Moisture Condition	Dormant Season (inches)	Growing Season (inches)
I	< 0.5	< 1.4
II	0.5 to 1.1	1.4 to 2.1
III	> 1.1	> 2.1

Varying AMC values are used in the design of evaporation pond BMPs in [BMP F6.30: Evaporation Ponds](#). See [Table 4.16: Curve Number Conversions for Antecedent Moisture Conditions \(Case Ia = 0.2S\)](#) for the CN conversions for different AMC values for the case of Ia = 0.2S. For other conversions, see the *National Engineering Handbook* ([USDA, 2004](#)).

**Table 4.16: Curve Number Conversions for Antecedent Moisture Conditions (Case Ia = 0.2S)**

Curve No. for AMC II	Curve No. for AMC I	Curve No. for AMC III	Curve No. for AMC II	Curve No. for AMC I	Curve No. for AMC III
100	100	100	76	58	89
99	97	100	75	57	88
98	94	99	74	55	88
97	91	99	73	54	87
96	89	99	72	53	86
95	87	98	71	52	86
94	85	98	70	51	85

**Table 4.16: Curve Number Conversions for Antecedent Moisture Conditions (Case Ia = 0.2S) (continued)**

Curve No. for AMC II	Curve No. for AMC I	Curve No. for AMC III	Curve No. for AMC II	Curve No. for AMC I	Curve No. for AMC III
93	83	98	69	50	84
92	81	97	68	48	84
91	80	97	67	47	83
90	78	96	66	46	82
89	76	96	65	45	82
88	75	95	64	44	81
87	73	95	63	43	80
86	72	94	62	42	79
85	70	94	61	41	78
84	68	93	60	40	78
83	67	93	59	39	78
82	66	92	58	38	76
81	64	92	57	37	75
80	63	91	56	36	75
79	62	91	55	35	74
78	60	90	54	34	73
77	59	89	50	31	70

Source: [\(USDA, 2004\)](#)

### Supplemental Guidelines

Local jurisdictions may wish to restrict the CNs used to describe the predeveloped or existing condition and generate the runoff in the proposed development condition. The lower CNs result in lower runoff and mitigate for past changes to the natural drainage patterns. Restricting the allowable CNs can also reduce the subjectivity that is inherent in the selection of CNs.

### Example

The following is an example of how CN values are selected for a sample project.

Select CNs for the following development:

Existing land use:	woods (thin stand, poor cover)
Future land use:	80% impervious
Basin size:	10 acres
Soil type:	80% Garfield, 20% Bonner, split between the pervious and impervious areas

[Table 4.13: Hydrologic Soil Series for Selected Soils in Eastern Washington](#) shows that Garfield soil belongs to the “C” hydrologic soil group and Bonner soil belongs to the “B” group. Therefore, for the existing condition, CNs of 77 and 66 are read from [Table 4.14: Runoff Curve Numbers \(CNs\) for Selected Agricultural, Suburban, and Urban Areas](#) and area weighted to obtain a CN value of 75.

For the proposed development condition with 80% impervious, the impervious and pervious areas are 8.0 acres and 2.0 acres, respectively. The impervious area CN value is 98. The 2.0 acres of pervious area consists of 70% grass landscaping covering the same proportions of Garfield and Bonner soil (80% and 20%, respectively). Therefore, for fair condition open space, CNs of 79 and 69 are read from [Table 4.14: Runoff Curve Numbers \(CNs\) for Selected Agricultural, Suburban, and Urban Areas](#) and area weighted to obtain a pervious area CN value of 77. The results of this example are summarized in [Table 4.17: Curve Number Example](#).

**Table 4.17: Curve Number Example**

On-Site Condition	Existing	Proposed
Land use	Woods	Multifamily
Pervious area	10.0 acres	2.0 acres
Curve number of pervious area	75	77
Impervious area	0 acres	8.0 acres
Curve number of impervious area	Not applicable	98

### SCS Curve Number Equations

The rainfall-runoff equation of the SCS curve number equations relate a land area’s runoff depth (precipitation excess) to the precipitation it receives and to its natural storage capacity. The runoff depth from a given watershed is solved with the following equations:

#### Equation 4.20: SCS Curve Number Equation 1

$$Q = \frac{[P - (0.2 * S)]^2}{P + (0.8 * S)}$$

#### Equation 4.21: SCS Curve Number Equation 2

$$S = \frac{1,000}{CN} - 10$$

$$Q = 0 \text{ for } P < 0.2 * S$$

where:

Q = actual direct runoff depth (inches)

P = total precipitation depth over the area (inches)

S = potential abstraction or potential maximum natural detention over the area due to infiltration, storage, etc. (inches)

CN = runoff curve number

The combination of [Equation 4.20: SCS Curve Number Equation 1](#) and [Equation 4.21: SCS Curve Number Equation 2](#) allows for estimation of the total runoff volume by computing the total runoff depth given the total precipitation depth for the storm of interest.

### Example

The following is an example for determining design treatment volume.

Project location:	Walla Walla
Area requiring treatment:	80% impervious
CN:	98
S:	$(1,000/98) - 10 = 0.20$
$P_{2\text{year},24\text{hour}}$ , from <a href="#">Figure 4.7: 2-Year, 24-Hour Isopluvial Map</a> :	1.2 inches
$C_{wqs}$ for Climate Region 3, from <a href="#">Table 4.5: Values of Coefficient <math>C_{wqs}</math> for Computing 6-Month, 24-Hour Precipitation</a> :	0.69
24-hour to regional storm precipitation depth conversion factor for Climate Region 3, from <a href="#">Table 4.6: Factors for Converting From 24-Hour to Regional Storm Precipitation Depth</a> :	1.06

The total amount of rainfall during the 24-hour storm is:

$$P_{wqs} = C_{wqs} * P_{2\text{year},24\text{hour}} = (0.69) * (1.2 \text{ inches}) = 0.83 \text{ inches}$$

The total amount of rainfall during the regional storm is:

$$P_{wqs} = (0.69) * (1.2 \text{ inches}) * (1.06) = 0.88 \text{ inches}$$

Continuing on with the rainfall from the regional storm, the amount (*depth*) of rainfall that becomes runoff is:

$$Q = [0.88 - 0.2 * (0.20)]^2 / [0.88 + 0.8 * (0.20)] = 0.68 \text{ inches}$$

This depth value represents inches over the entire contributing area. The total *volume* of runoff is found by multiplying this depth by the area, with necessary conversion from inches \* acres to cubic feet (cf):

$$\text{Total runoff volume (cf)} = (3,630 \text{ cf/acre-in}) * Q * A$$

The total runoff volume is:

$$3,630 \text{ cf/acre-in} * 0.68 \text{ inches} * 4.5 \text{ acres} = 11,108 \text{ cf}$$

This is the basis for design of runoff treatment BMPs for which the design is based on the total volume of runoff during the water quality design storm.

When developing the runoff hydrograph, [Equation 4.20: SCS Curve Number Equation 1](#) is used to compute the incremental runoff depth for each time interval from the incremental precipitation depth given by the design storm hyetograph. This time distribution of runoff depth is often referred to as the precipitation excess and provides the basis for synthesizing the runoff hydrograph.

## 4.7 Level-Pool Routing Method

This section presents a general description of the methodology for routing a hydrograph through an existing retention/detention BMP or closed depression, or for sizing a new retention/detention BMP using hydrograph analysis.

The “level-pool routing” technique presented here is one of the simplest and most commonly used hydrograph routing methods. This method, which is described in the *Handbook of Applied Hydrology* ([Chow, 1964](#)), is based on the continuity equation:

### Equation 4.22: Level-Pool Routing Method Equation 1

Inflow - Outflow = Change in storage

$$\left[ \frac{I_1 + I_2}{2} - \frac{O_1 + O_2}{2} \right] = \frac{S}{t} = S_2 - S_1$$

where:

$I_1$  and  $I_2$  = inflow at time 1 ( $t_1$ ) and time 2 ( $t_2$ ) (cubic feet [cf])

$O_1$  and  $O_2$  = outflow at  $t_1$  and  $t_2$  (cf)

$S_1$  and  $S_2$  = storage at  $t_1$  and  $t_2$  (cubic feet per minute [cf/min])

$\Delta t$  = time interval, or  $t_2$  minus  $t_1$  (minutes)

The time interval,  $\Delta t$ , must be consistent with the time interval used in developing the inflow hydrograph. The time interval used for the 6-hour storm is 5 minutes, while the time interval for the 72-hour storm is 30 minutes. The  $\Delta t$  variable can be eliminated by dividing it into the storage variables to obtain the following rearranged equation:

### Equation 4.23: Level-Pool Routing Method Equation 2

$$I_1 + I_2 + (2 * S_1) - O_1 = O_2 + (2 * S_2)$$

The terms on the left-hand side [Equation 4.23: Level-Pool Routing Method Equation 2](#) are known from the inflow hydrograph and from the storage and outflow values of the previous time step. The

unknowns ( $O_2$  and  $S_2$ ) can be solved interactively from the given stage-storage and stage-discharge curves.

The following steps are required in performing level-pool routing:

- Develop stage-storage relationship, which is a function of inflow and pond geometry.
- Develop the routing curve for the hydrograph and pond, which is a graph of outflow from the pond at a given stage versus the quantity  $O + (2 * S)$  for the same stage. The outflow is a function of stage (head above the orifice) and the control structure configuration.
- Route the inflow hydrograph through the proposed BMP by applying the continuity equation ([Equation 4.22: Level-Pool Routing Method Equation 1](#)) at each time step, where the inflow hydrograph supplies values of  $I$ , the stage-storage relationship supplies values of  $S$ , and the routing curve supplies values of  $O$ .

**Note:** The commercially available SBUH computer models use the level-pool routing method to shift hydrographs and size infiltration and detention BMPs.

## 4.8 Rational Method

### 4.8.1 Introduction

#### *Applicability*

The Rational Method is an allowable method for computing peak runoff rates for flow-based runoff treatment BMPs such as biofiltration swales and oil and water separators. It is also a common method for computing the peak runoff rate for design of drywells and conveyance systems.

#### *Supplemental Guidelines*

The greatest accuracy is obtained for areas smaller than 100 acres and for developed conditions with large areas of impervious surface (e.g., pavement, rooftops). Basins up to 1,000 acres may be evaluated using the rational formula; however, results for large basins often do not properly account for effects of infiltration and thus are less accurate. Designers should never perform a Rational Method analysis on a basin that is larger than the lower limit specified for the U.S. Geological Survey (USGS) regression equations because the USGS regression equations will yield a more accurate flow prediction for that size of basin.

#### *Procedure*

Design peak runoff rates may be determined by the Rational Method formula:

#### **Equation 4.24: Rational Method**

$$Q = C * I * A$$

where:

$Q$  = runoff (cubic feet per second [cfs])

$C$  = runoff coefficient (dimensionless units)



I = rainfall intensity (inches per hour [in/hr])

A = contributing area (acres)

The runoff coefficient C should be based on [Table 4.18: Values of Runoff Coefficient C for Use in Rational Method With Return Intervals of 10 Years or Less](#).

The coefficients in [Table 4.18: Values of Runoff Coefficient C for Use in Rational Method With Return Intervals of 10 Years or Less](#) are applicable for peak storms of 10-year frequency. Less frequent, higher intensity storms will require the use of higher coefficients because infiltration and other losses have a proportionally smaller effect on runoff. Generally, the coefficient should be increased by 10% when designing for a 25-year frequency; by 20% for 50-year; and by 25% for 100-year. The runoff coefficient should not be increased to > 0.95 unless approved by the local jurisdiction. Higher values may be appropriate for steeply sloped areas and/or longer return periods, because in these cases infiltration and other losses have a proportionally smaller effect on runoff.

The equation for calculating rainfall intensity is:

### Equation 4.25: Rainfall Intensity (Rational Method)

$$I = m / (T_c)^n$$

where:

I = rainfall intensity (in/hr)

T<sub>c</sub> = time of concentration (minutes)

m and n = rainfall intensity coefficients (dimensionless units), from [Table 4.19: Values of Rainfall Coefficients m and n for Selected Cities](#) for selected cities in eastern Washington; these coefficients have been determined for all major cities for the 2-, 10-, 25-, 50-, and 100-year mean recurrence intervals (MRIs) based on NOAA Atlas 2 ([Miller et al., 1973](#)).

**Table 4.18: Values of Runoff Coefficient C for Use in Rational Method With Return Intervals of 10 Years or Less**

Cover	Flat	Rolling 2% to 10%	Hilly > 10%
Pavement and Roofs	0.90	0.90	0.90
Earth Shoulders	0.50	0.50	0.50
Drives and Walks	0.75	0.80	0.85
Gravel Pavement	0.50	0.55	0.60
City Business Areas	0.80	0.85	0.85
Suburban Residential	0.25	0.35	0.40
Single Family Residential	0.30	0.40	0.50

**Table 4.18: Values of Runoff Coefficient C for Use in Rational Method With Return Intervals of 10 Years or Less (continued)**

Cover	Flat	Rolling 2% to 10%	Hilly > 10%
Lawns, Sandy Soil	0.10	0.15	0.20
Lawn, Heavy Soil	0.17	0.22	0.35
Grass Shoulders	0.25	0.25	0.25
Side Slopes, Earth	0.60	0.60	0.60
Side Slopes, Turf	0.30	0.30	0.30
Median Areas, Turf	0.25	0.30	0.30
Cultivated Land, Clay and Loam	0.50	0.55	0.60
Cultivated Land, Sand and Gravel	0.25	0.30	0.35
Industrial Areas, Light	0.50	0.70	0.80
Industrial Areas, Heavy	0.60	0.80	0.90
Parks and Cemeteries	0.10	0.15	0.25
Playgrounds	0.20	0.25	0.30
Woodland and Forests	0.10	0.15	0.20
Meadows and Pasture Land	0.25	0.30	0.35
Pasture with Frozen Ground	0.40	0.45	0.50
Unimproved Areas	0.10	0.20	0.30
Source: WSDOT <i>Hydraulics Manual</i> ( <a href="#">WSDOT, 2017</a> ).			

**Table 4.19: Values of Rainfall Coefficients *m* and *n* for Selected Cities**

Location	2-Year MRI		10-Year MRI		25-Year MRI		50-Year MRI		100-Year MRI	
	<i>m</i>	<i>n</i>	<i>m</i>	<i>n</i>	<i>m</i>	<i>n</i>	<i>m</i>	<i>n</i>	<i>m</i>	<i>n</i>
Clarkston and Colfax	5.02	0.628	8.24	0.635	10.07	0.638	11.45	0.639	12.81	0.639
Colville	3.48	0.558	6.98	0.610	9.07	0.626	10.65	0.635	12.26	0.642
Ellensburg	2.89	0.590	7.00	0.649	9.43	0.664	11.30	0.672	13.18	0.678
Leavenworth	3.04	0.530	5.62	0.575	7.94	0.594	9.75	0.606	11.08	0.611
Moses Lake	2.61	0.583	6.99	0.655	9.58	0.671	11.61	0.681	13.63	0.688
Omak	3.04	0.583	6.63	0.633	8.74	0.647	10.35	0.654	11.97	0.660
Pasco and Kennewick	2.89	0.590	7.00	0.649	9.43	0.664	11.30	0.672	13.18	0.678
Snoqualmie Pass	3.61	0.417	6.56	0.459	7.72	0.459	8.78	0.461	10.21	0.476
Spokane	3.47	0.556	6.98	0.609	9.09	0.626	10.68	0.635	12.33	0.643
Stevens Pass	4.73	0.462	8.19	0.500	8.53	0.484	10.61	0.499	12.45	0.513
Walla Walla	3.33	0.569	7.30	0.627	9.67	0.645	11.45	0.653	13.28	0.660
Wenatchee	3.15	0.535	6.19	0.579	7.94	0.592	9.32	0.600	10.68	0.605
Yakima	3.86	0.608	7.37	0.644	9.40	0.654	10.93	0.659	12.47	0.663

Source: WSDOT *Hydraulics Manual* ([WSDOT, 2017](#)).

Note: *m* and *n* are rainfall intensity coefficients in dimensionless units (English).

MRI = mean recurrence interval.

**4.8.2 Time of Concentration for Rational Method**

Time of concentration ( $T_c$ ) is defined as the time for runoff to travel from the hydraulically most distant point of the watershed to a point of interest in the watershed. Travel time ( $T_t$ ) is the time it takes water to travel from one location to another in a watershed. Travel time is a component of time of concentration, which is computed by summing all the travel times for consecutive components of the drainage flow path. This concept assumes that rainfall is applied at a constant rate over a drainage basin which would eventually produce a constant peak rate of runoff.

Actual precipitation does not fall at a constant rate. A precipitation event will generally begin with low rainfall intensity and then, sometimes very quickly, build to peak intensity, and eventually taper down to no rainfall. Because rainfall intensity is variable, the time of concentration is included in the rational method so that the designer can determine the proper rainfall intensity to apply across the basin. The intensity that should be used for design purposes is the highest intensity that will occur with the entire basin contributing flow to the location where the designer is interested in knowing the flow rate. It is important to note that this may be a much lower intensity than the absolute maximum intensity. The reason is that it often takes several minutes before the entire basin is contributing flow, but the absolute maximum intensity lasts for a much shorter time so the rainfall intensity that creates the greatest runoff is less than the maximum by the time the entire basin is contributing flow.

Most drainage basins will consist of different types of ground covers and conveyance systems that flow must pass over or through. These are referred to as flow segments. It is common for a basin to have flow segments that are overland flow and flow segments that are open channel flow. Urban drainage basins often have flow segments that are flow through a storm drain pipe in addition to the other two types. A travel time (the amount of time required for flow to move through a flow segment) must be computed for each flow segment. The time of concentration is equal to the sum of all the flow segment travel times.

For a few contributing areas, a unique situation occurs where the time of concentration that produces the largest amount of runoff is less than the time of concentration for the entire basin. This can occur when two or more subbasins have dramatically different types of cover (i.e., different runoff coefficients). The most common case would be a large paved area together with a long narrow strip of natural area. In this case, the designer should check the runoff produced by the paved area alone to determine if this scenario would cause a greater peak runoff rate than the peak runoff rate produced when both land segments are contributing flow. The scenario that produces the greatest runoff should be used, even if the entire basin is not contributing flow to this runoff.

The procedure described in [Equation 4.26: Time of Concentration for Overland Flow](#) and [Equation 4.27: Travel Time of Flow Segment](#) for determining the time of concentration for overland flow was developed by the Natural Resources Conservation Service (NRCS). It is sensitive to slope, type of ground cover, and the size of channel. If the total time of concentration is < 5 minutes, a minimum of 5 minutes should be used as the duration. The time of concentration can be calculated as follows:

#### **Equation 4.26: Time of Concentration for Overland Flow**

$$T_c = T_{t1} + T_{t2} + \dots + T_{tnz}$$

using:

#### **Equation 4.27: Travel Time of Flow Segment**

$$T_t = \frac{L}{K\sqrt{S}} = \frac{L^{1.5}}{K\sqrt{H}}$$

where:

$T_c$  = time of concentration (minutes)

$T_t$  = travel time of flow segment (minutes)

L = length of segment (feet or meters)

K = ground cover coefficient from Table 4.8.3 (feet/minute or meters/minute)

S = slope of segment  $\frac{H}{L}$  (feet per foot or meter per meter)

$\Delta H$  = elevation change in elevation across segment (feet or meters)

**Table 4.20: Values of Ground Cover Coefficient K**

Cover or Channel Type	Depth or Diameter	K (English)	K (Metric)
Forest with heavy ground cover	Not applicable	150	50
Minimum tillage cultivation	Not applicable	280	75
Short pasture grass or lawn	Not applicable	420	125
Nearly bare ground	Not applicable	600	200
Small roadside ditch w/grass	Not applicable	900	275
Paved area	Not applicable	1,200	375
Gutter flow	4 inches (100 mm) deep	1,500	450
	6 inches (150 mm) deep	2,400	725
	8 inches (200 mm) deep	3,100	950
Drainage system	1 foot (300 mm) diameter	3,000	925
	18 inches (450 mm) diameter	3,900	1,200
	2 foot (600 mm) diameter	4,700	1,425
Open channel flow (n = 0.040)	1 foot (300 mm) deep	1,100	350
in a narrow channel (w/d = 1)	2 feet (600 mm) deep	1,800	550
	4 feet (1.20 meters) deep	2,800	850
Open channel flow (n = 0.040)	1 foot (300 mm) deep	2,000	600
in a wide channel (w/d = 9)	2 feet (600 mm) deep	3,100	950
	4 feet (1.20 m) deep	5,000	1,525
Source: WSDOT <i>Hydraulics Manual</i> ( <a href="#">WSDOT, 2017</a> ) d = depth mm = millimeters n = Manning's <i>n</i> w = width			

*This page has been intentionally left blank for double-sided printing.*

# Appendix 4-A: Background Information on Design Storms and Selected Modeling Methods

## 4.A.1 Introduction

As an early step in the process of developing a technical stormwater manual, short- and long-duration design storms were identified for eastern Washington by MGS Engineering Consultants at the request of the Eastern Washington Stormwater Management Project Steering Committee for the 2004 *Stormwater Management Manual for Eastern Washington* (manual). Questions were raised by some members of the Manual Subcommittee for the 2004 manual and during the public review and comment period on the first draft of the 2004 manual concerning the practical application and reliability of using the long-duration design storms as input for commonly used modeling methods and software. For the final draft version of the manual, subsequent work was performed by Harper Houf Righellis, Inc., at the request of the Eastern Washington Stormwater Management Project Manual Subcommittee and Technical Advisory Group. Harper Houf Righellis, Inc., reviewed the work by MGS Engineering Consultants and recommended appropriate modeling approaches for use by the general engineering and project design community.

This appendix includes summaries of the work performed by both MGS Engineering Consultants ([4.A.2 Development of Short- and Long-Duration Design Storms for Eastern Washington](#)) and Harper Houf Righellis, Inc. ([4.A.3 Review of Design Storms and Identification of Best Rainfall-Runoff Modeling Approaches for Eastern Washington](#)).

[Appendix 4-B: Historical Storms Used to Develop Design Storms in Eastern Washington](#) and [Appendix 4-C: Long-Duration Storm Hyetographs for Eastern Washington](#) provide additional detailed information about the short- and long-duration design storms: the precipitation data used to identify the four climate regions of eastern Washington and generate the storms; and the resulting 72-hour, two-peak hyetographs for each of the four climate regions.

The 72-hour long-duration hyetographs published in [Appendix 4-C: Long-Duration Storm Hyetographs for Eastern Washington](#) are not currently recommended for direct use. There is concern that the single-event hydrograph methods do not produce realistic results when using multipeak hyetographs. In the Soil Conservation Service (SCS) hydrograph method, the initial abstraction (loss) is computed from the first contribution of rainfall with no accounting for the dry period between the two hyetographs to allow for initial abstraction again. This produces greater peak flows and runoff volumes than would otherwise be computed using just the second hyetograph, even while the first hyetograph is not sufficient to generate direct runoff or substantially increase soil moisture present at the start of the second hyetograph.

## 4.A.2 Development of Short- and Long-Duration Design Storms for Eastern Washington

This section summarizes the work performed by MGS Engineering Consultants for the 2004 manual.

## **Overview of Storm Types**

There are two storm types of interest for stormwater analyses in eastern Washington. Short-duration thunderstorms can occur in the late spring through early fall seasons and are characterized by high intensities for short periods of time over localized areas. These types of storms can produce high rates of runoff and flash flooding and are important where flood peak discharge and/or erosion are design considerations.

Long-duration general storms can occur at any time of the year, but are more common in the late fall through winter period, and in the late spring and early summer periods. General storms in eastern Washington are characterized by sequences of storm activity and intervening dry periods, often occurring over several days. Low- to moderate-intensity precipitation is typical during the periods of storm activity. These types of events can produce floods with large runoff volumes and moderate peak discharge. The runoff volume can be augmented by snowmelt when precipitation falls on snow during winter and early spring storms. These types of storm events are important where both runoff volume and peak discharge are design considerations.

Design storms are constructed using two components: a precipitation magnitude for a specified duration and a dimensionless storm pattern. The precipitation magnitude for the specified duration is determined based on the desired level of service (return period of the storm, years) and is used to scale the dimensionless storm pattern to produce the design storm. Specifically, the 2-hour precipitation amount for a selected return period is used for scaling the short-duration thunderstorm. The 24-hour precipitation amount for a selected return period is used for scaling the long-duration general storm.

This appendix provides information on the methods and data that were used for analysis and development of design storms for both short-duration thunderstorms and long-duration general storms. The dimensionless storm patterns for the short-duration thunderstorm and long-duration general storm were developed from analyses of historical storms and contain storm characteristics that are representative of the conditions frequently observed in significant storms.

## **Climate Regions**

Eastern Washington has been divided into four climate regions to reflect differences in storm characteristics and the seasonality of storms. The four climate regions (see [Figure 4.1: Average Annual Precipitation and Climate Regions](#)) are described below.

### **Climate Region 1 – East Slopes of Cascade Mountains**

This climate region consists of mountain areas on the east slopes of the Cascade Mountains. It is bounded to the west by the Cascade crest and bounded to the east by a generalized contour line of 16 inches of mean annual precipitation.

### **Climate Region 2 – Central Basin**

This climate region consists of the Columbia Basin and adjacent low-elevation areas in central Washington. It is bounded to the west by the generalized contour line of 16 inches of mean annual precipitation that forms the east slopes of the Cascade Mountains, and bounded to the north by the contour line of 12 to 14 inches of mean annual precipitation and to the east by the contour line of 12 inches of mean annual precipitation. Many of the larger cities in eastern Washington are in this



climate region including: Ellensburg, Kennewick, Moses Lake, Pasco, Richland, Wenatchee, and Yakima.

### **Climate Region 3 – Okanogan, Spokane, Palouse**

This climate region consists of intermountain areas and includes areas near Okanogan, Spokane, and the Palouse. It is bounded to the west by the east slopes of the Cascade Mountains and the Central Basin, bounded to the northeast by the Kettle River Range and Selkirk Mountains, and bounded to the southeast by the Blue Mountains. It generally occupies an area with mean annual precipitation ranging from 14 to 22 inches.

### **Climate Region 4 – Northeastern Mountains and Blue Mountains**

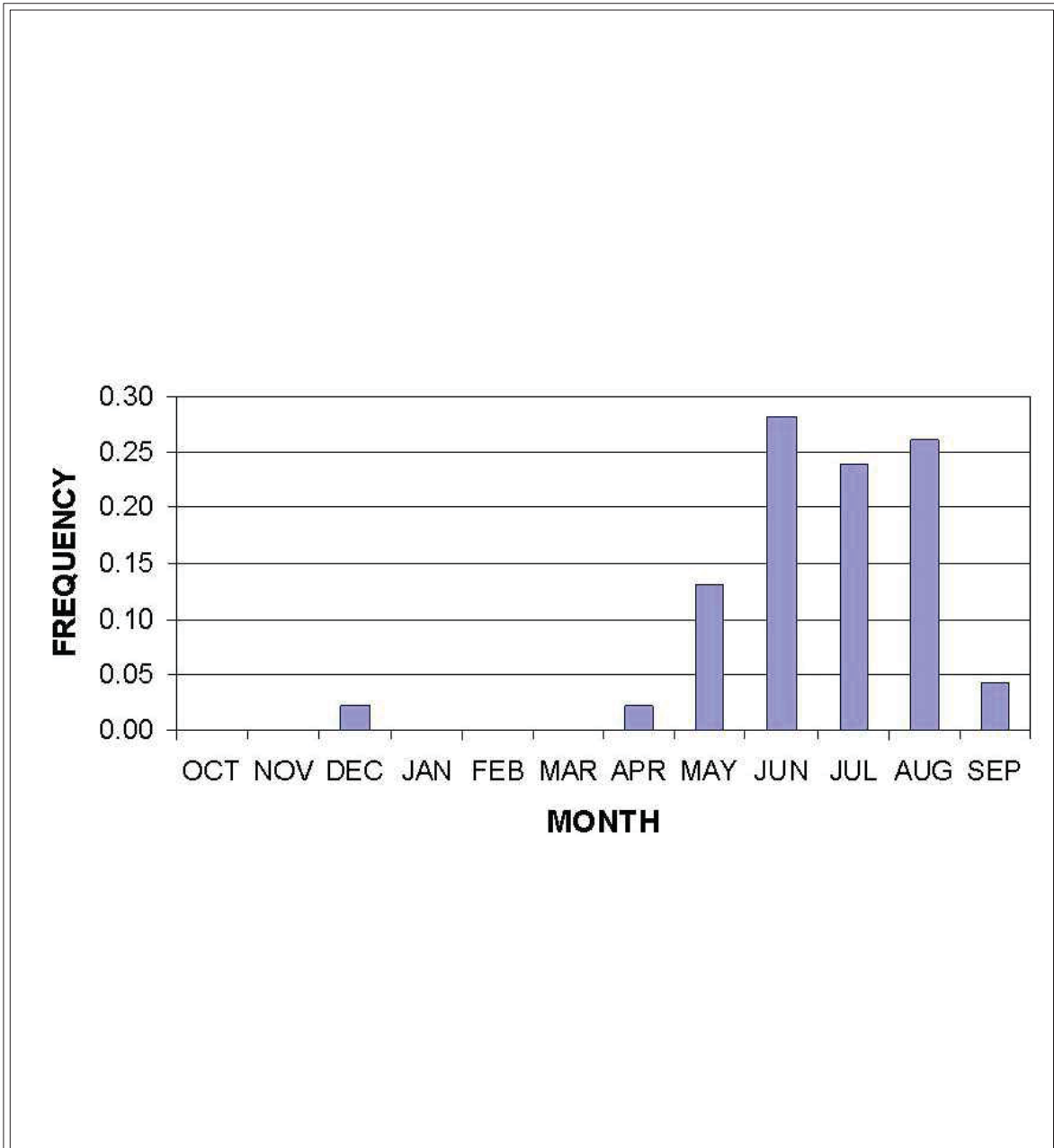
This climate region consists of mountain areas in the easternmost part of Washington State. It includes portions of the Kettle River Range and Selkirk Mountains in the northeast, and includes the Blue Mountains in the southeast corner of eastern Washington. Mean annual precipitation ranges from a minimum of 22 to over 60 inches. The western boundary of this climate region is a generalized contour line of 22 inches mean annual precipitation.

### **Seasonality of Storms**

Information on the seasonality of storms is useful in providing information for selection of antecedent conditions to be used with the design storms for rainfall-runoff modeling at undeveloped sites.

Short-duration thunderstorms are warm season events that occur from late spring through early fall throughout eastern Washington ([Figure 4.13: Seasonality of Short-Duration Thunderstorms in Eastern Washington](#)). Antecedent conditions for rainfall-runoff modeling of thunderstorms should be selected consistent with the conditions expected at the time of year when thunderstorms have historically occurred.

**Figure 4.13: Seasonality of Short-Duration Thunderstorms in Eastern Washington**



DEPARTMENT OF  
**ECOLOGY**  
State of Washington

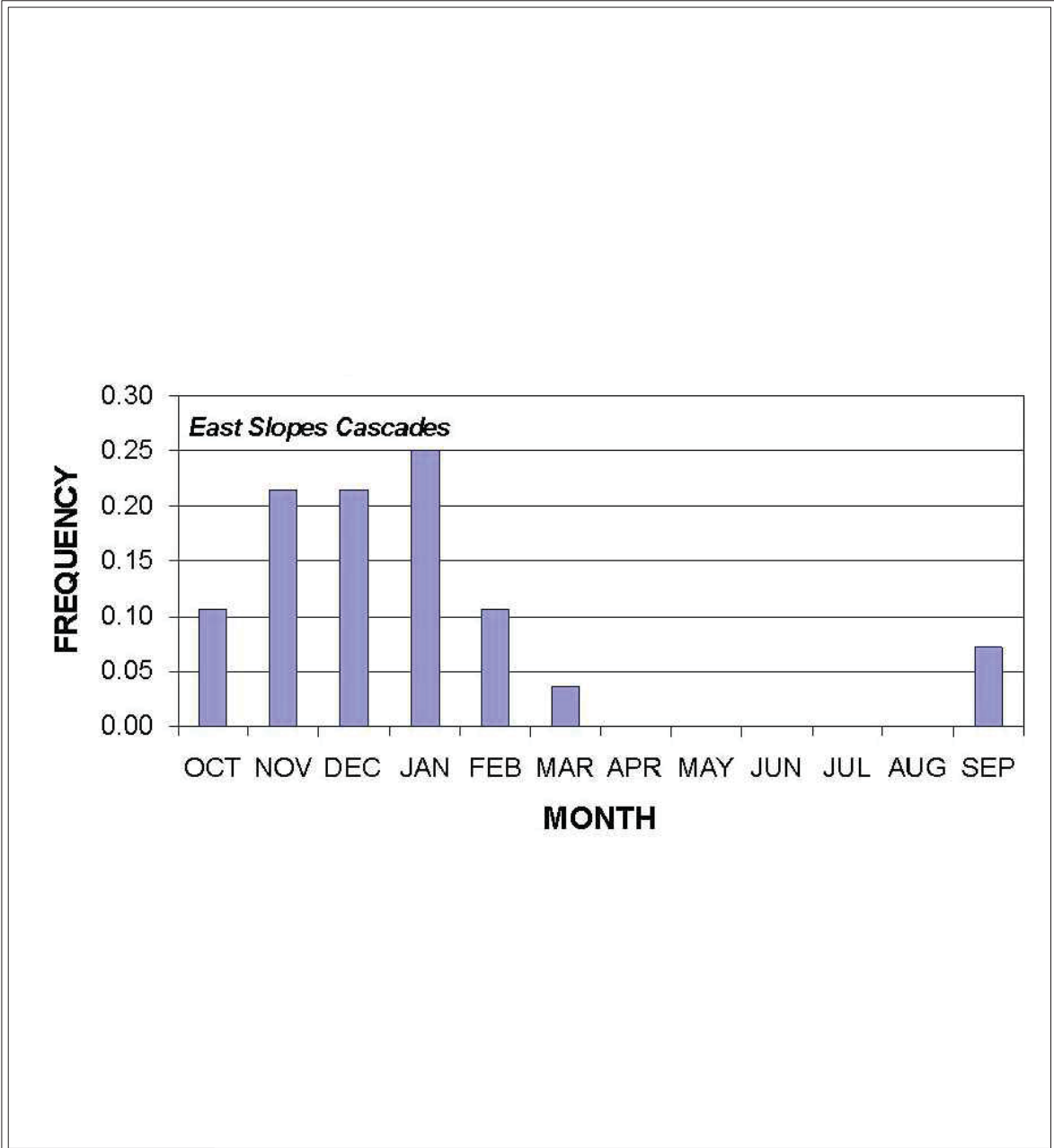
### Seasonality of Short-Duration Thunderstorms in Eastern Washington

Revised September 2004

Please see <http://www.ecy.wa.gov/copyright.html> for copyright notice including permissions, limitation of liability, and disclaimer.

The seasonality of long-duration general storms varies across eastern Washington. General storms occur in late fall and winter on the east slopes of the Cascade Mountains ([Figure 4.14: Seasonality of Long-Duration General Storms for the East Slopes of the Cascade Mountains](#)) and are generally associated with concurrent storm activity in western Washington. In contrast, general storms in the more eastern climate regions may or may not be associated with concurrent storms in western Washington. Long-duration general storms occur in both the cool and warm seasons in the Central Basin, Okanogan, Spokane, and Palouse regions. The storm seasons are reasonably well defined with more frequent storm activity from fall through early spring, and from late spring through early summer ([Figure 4.15: Seasonality of Long-Duration General Storms for the Central Basin, Okanogan, Spokane, and Palouse](#)). The seasonality of long-duration general storms in the eastern mountain areas is similar to that for Climate Regions 2 and 3, except that the winter season is dominant ([Figure 4.16: Seasonality of Long-Duration General Storms for the Northeastern Mountains and Blue Mountains](#)) with a greater frequency of storm events in the winter season. These seasonalities of storm occurrences should be considered when selecting antecedent conditions for rainfall-runoff modeling.

**Figure 4.14: Seasonality of Long-Duration General Storms for the East Slopes of the Cascade Mountains**



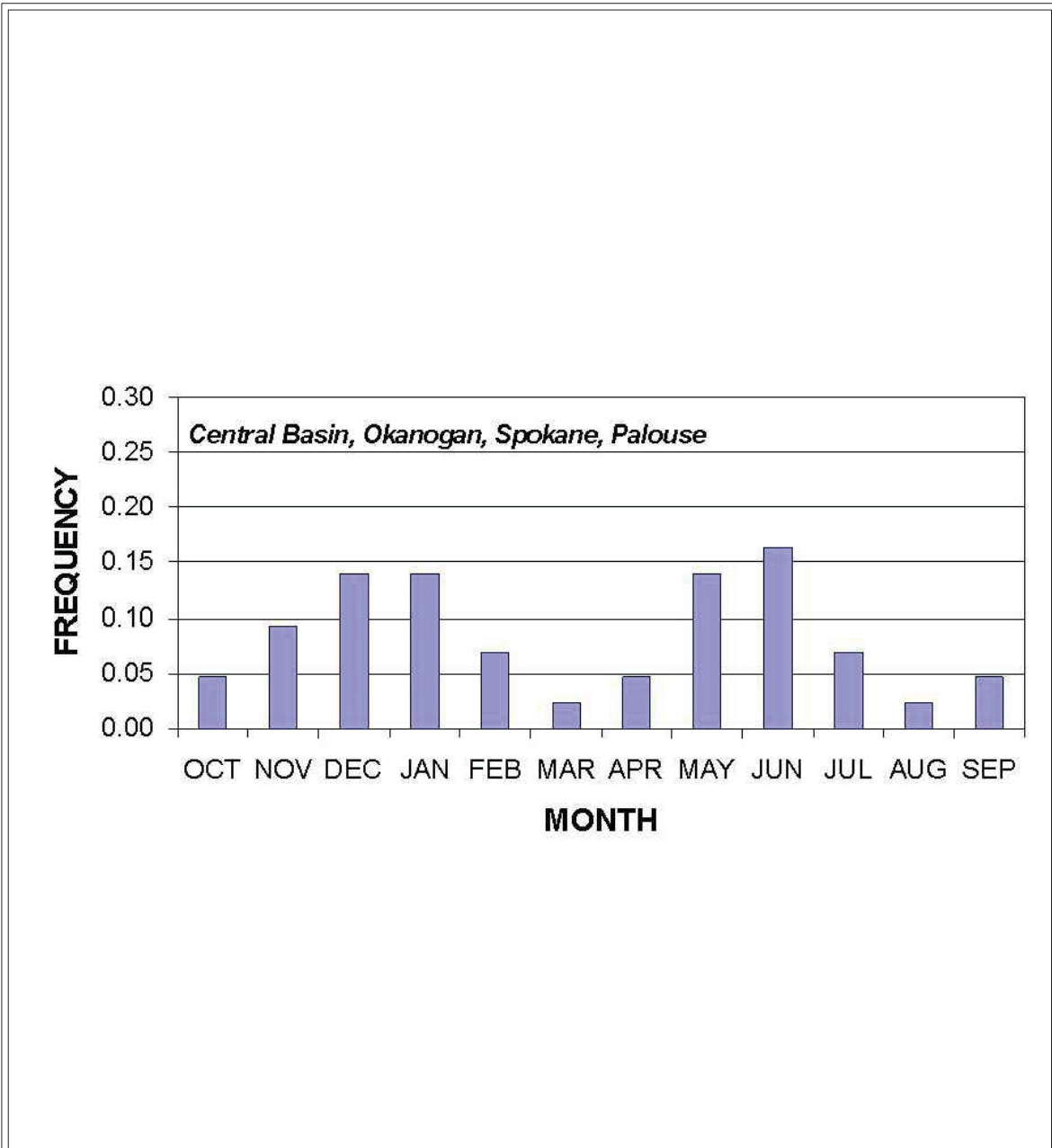
DEPARTMENT OF  
**ECOLOGY**  
State of Washington

Seasonality of Long-Duration General Storms for  
the East Slopes of the Cascade Mountains

Revised September 2004

Please see <http://www.ecy.wa.gov/copyright.html> for copyright notice including permissions, limitation of liability, and disclaimer.

**Figure 4.15: Seasonality of Long-Duration General Storms for the Central Basin, Okanogan, Spokane, and Palouse**



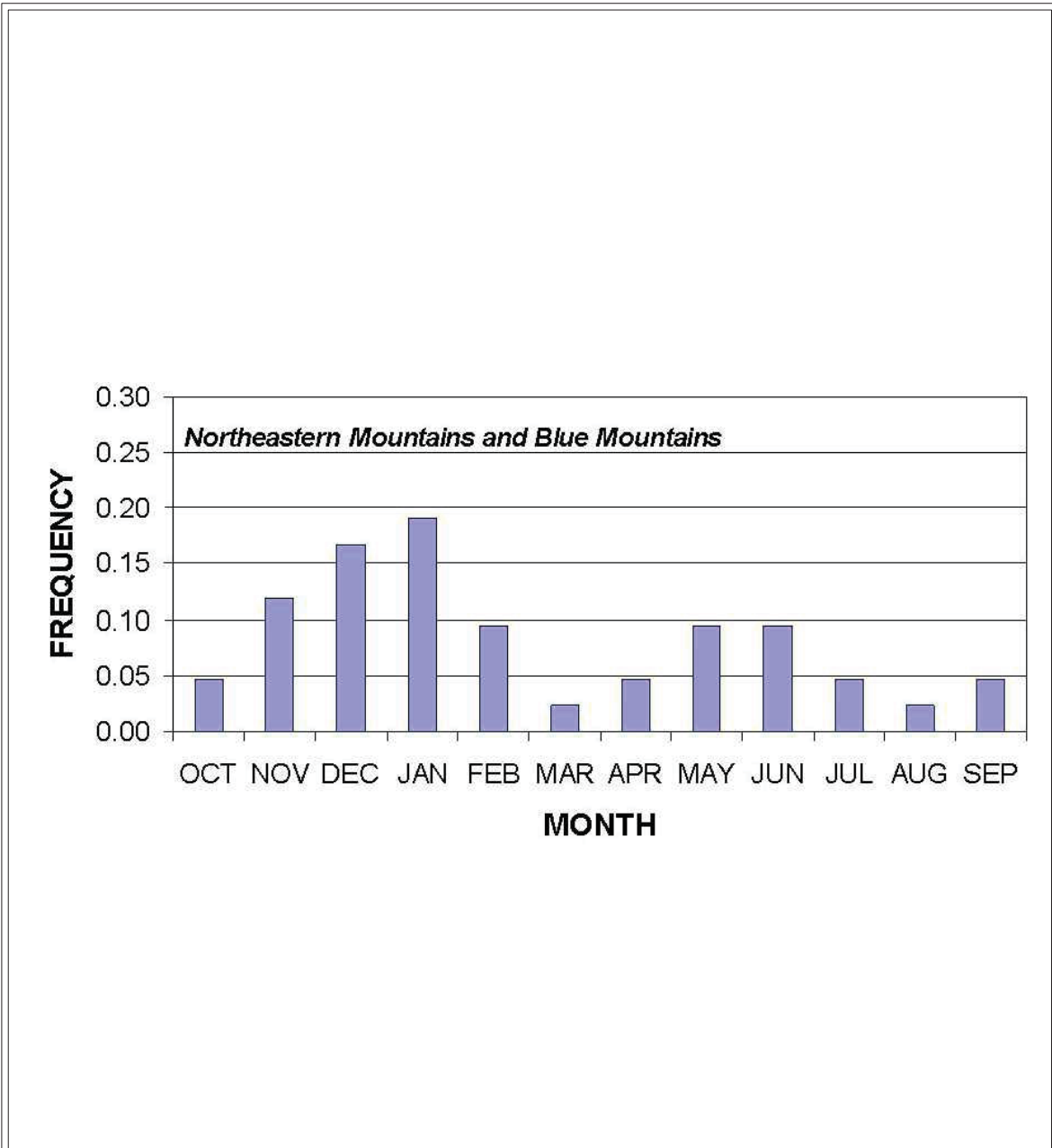
DEPARTMENT OF  
**ECOLOGY**  
State of Washington

Seasonality of Long-Duration General Storms for  
the Central Basin, Okanogan, Spokane, and  
**Palouse**

Revised September 2004

Please see <http://www.ecy.wa.gov/copyright.html> for copyright notice including permissions, limitation of liability, and disclaimer.

**Figure 4.16: Seasonality of Long-Duration General Storms for the Northeastern Mountains and Blue Mountains**



DEPARTMENT OF  
**ECOLOGY**  
State of Washington

Seasonality of Long-Duration General Storms for the Northeastern Mountains and Blue Mountains

Revised September 2004

Please see <http://www.ecy.wa.gov/copyright.html> for copyright notice including permissions, limitation of liability, and disclaimer.

## **Dimensionless Design Storm Patterns**

The temporal pattern of a design storm is important because it influences the magnitude of the flood peak discharge and runoff volume produced by the storm. Elements of the design storm that are important in rainfall-runoff modeling include total storm volume; storm duration; maximum intensity during the storm; duration of the high-intensity portion(s) of the storm; elapsed time to the high-intensity portion of the storm; and the magnitude, sequencing and temporal pattern of incremental precipitation amounts within the storm. Each of these storm characteristics was examined in the analysis of historical storms in eastern Washington. The storm characteristics were analyzed using a variety of procedures developed by the National Weather Service ([Frederick et al., 1981](#)), ([National Weather Service, 1994](#)), ([Schaefer, 1989](#)), and the U.S. Geological Survey ([Parrett, 1998](#)). A total of 37 short-duration thunderstorms and 59 long-duration general storms that occurred in the period from 1940 to 2000 were analyzed. [Appendix 4-B: Historical Storms Used to Develop Design Storms in Eastern Washington](#) contains a listing of storm dates, locations, and precipitation amounts for storms that were analyzed.

Dimensionless design storms for the short-duration thunderstorm and long-duration general storm were developed in a manner to contain storm characteristics that are representative of the conditions observed in historical storms. Specifically, mean values of storm characteristics and commonly occurring temporal patterns were used in assembling the design storm temporal patterns.

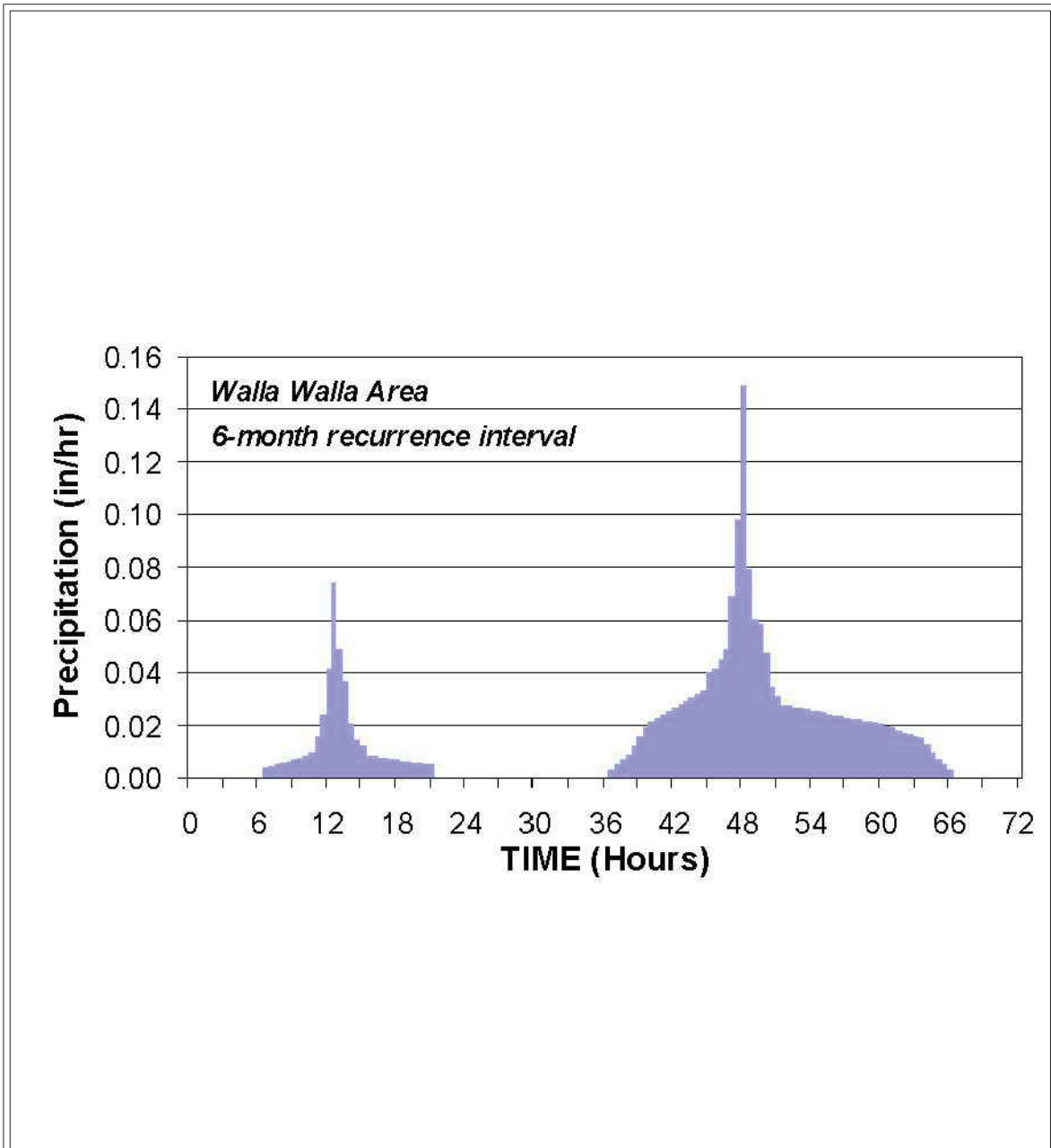
## **Long-Duration General Storms**

Long-duration general storms in eastern Washington are associated with organized weather systems that produce low- to moderate-intensity precipitation over broad areas. General storms typically consist of sequences of storm activity and intervening dry periods, often occurring over several days. Each of these important characteristics is preserved in the long-duration dimensionless storm patterns.

While many of the characteristics of general storms are similar throughout eastern Washington, some storm characteristics vary by climate region. For example, in mountain areas, the duration of precipitation is longer and the length of intervening dry periods is shorter, relative to that in the Central Basin. Thus, separate long-duration design storm patterns were needed for each climate region.

An example of a scaled long-duration design storm is shown in [Figure 4.17: Example Long-Duration Design Storm](#), which was obtained by scaling (multiplying) the incremental ordinates of the dimensionless design storm (see [Table 4.28: 72-Hour Long-Duration Storm Hyetograph Values for Climate Region 2: Central Basin](#)) by a 24-hour precipitation value of 0.82 inches. Differences in temporal patterns between the four climate regions can be seen in [Figure 4.20: Long-Duration Design Storm for Climate Region 1](#) through [Figure 4.23: Long-Duration Design Storm for Climate Region 4](#), which compare long-duration water quality design storms for the four climate regions.

**Figure 4.17: Example Long-Duration Design Storm**



### Example Long-Duration Design Storm

Revised September 2004

Please see <http://www.ecy.wa.gov/copyright.html> for copyright notice including permissions, limitation of liability, and disclaimer.

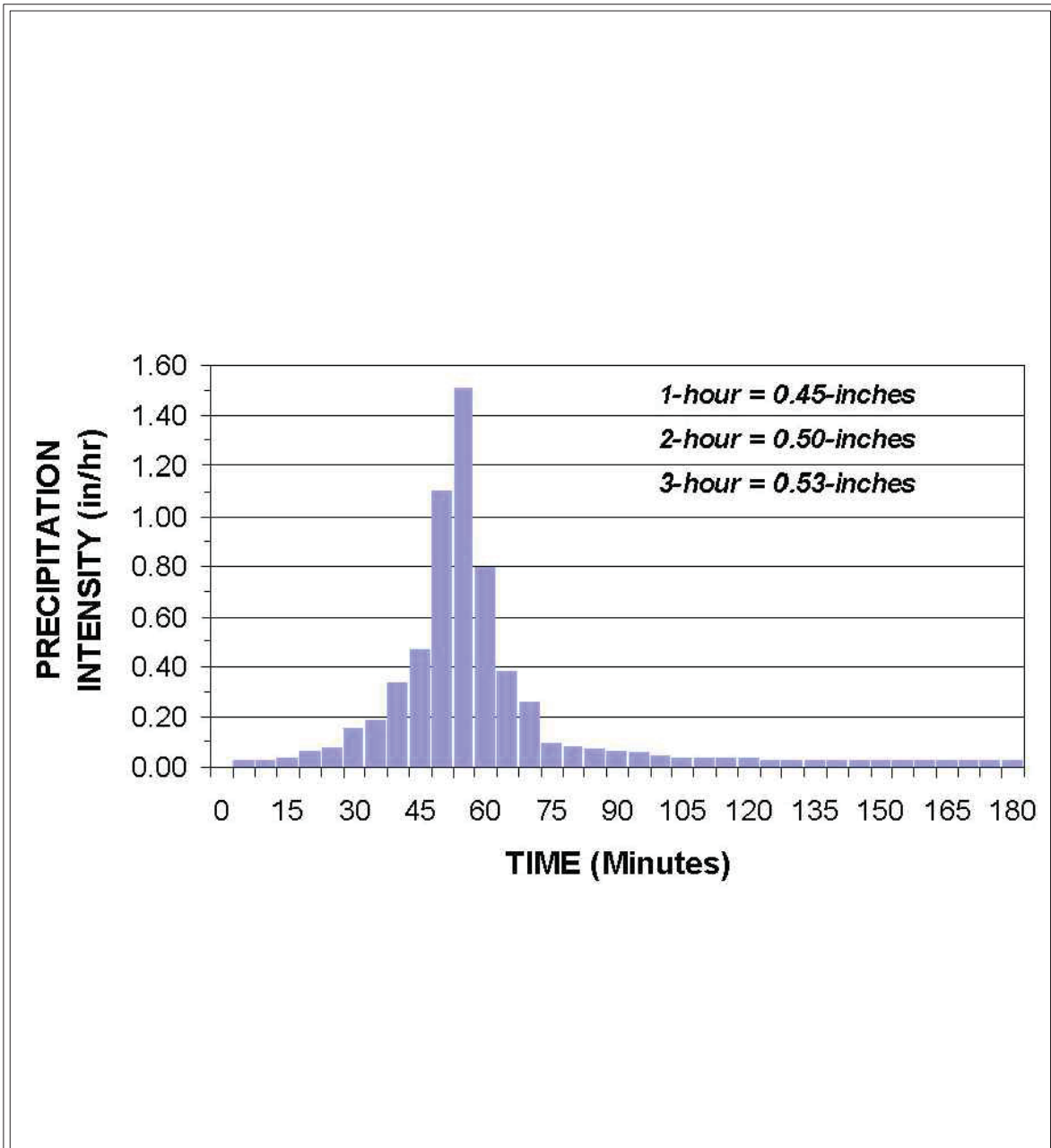


## **Short-Duration Thunderstorms**

Short-duration thunderstorms are characterized by very high intensity rainfall occurring over isolated areas. The duration of the high-intensity portion of the storm may last from 5 to 30 minutes with a total duration typically ranging from less than an hour to several hours. These storms are convective events, commonly occurring in the late afternoon and early-evening hours in the summer where atmospheric instabilities are often driven by solar heating. They are frequently accompanied by lightning and thunder.

Analysis of historical storms indicates that short-duration thunderstorms have similar characteristics throughout eastern Washington. Therefore, one dimensionless design storm pattern is applicable to all four climate regions. An example of a scaled short-duration design storm is shown in [Figure 4.18: Example Short-Duration Design Storm](#), which was obtained by scaling (multiplying) the incremental ordinates of the dimensionless design storm (see [Table 4.7: Values of the Coefficient  \$C\_{sds}\$  for Using 2-Year, 2-Hour Precipitation to Compute 2-Hour Precipitation for Selected Periods of Return](#)) by a 2-hour precipitation value of 0.50 inches.

**Figure 4.18: Example Short-Duration Design Storm**



## Example Short-Duration Design Storm

Revised September 2004

Please see <http://www.ecy.wa.gov/copyright.html> for copyright notice including permissions, limitation of liability, and disclaimer.

## **4.A.3 Review of Design Storms and Identification of Best Rainfall-Runoff Modeling Approaches for Eastern Washington**

This section summarizes the work performed by Harper Houf Righellis, Inc.

### **Overview**

The best available modeling approaches for using short- and long-duration design storms to size runoff treatment and flow control Best Management Practices (BMPs) in eastern Washington were identified and recommended in a concurrent effort. A “big picture” approach was implemented and three storm types were reviewed:

- Short-duration storm (3-hour), intended to represent a summer thundershower.
- Soil Conservation Service (SCS) Type II storm (24-hour), the standard storm pattern established by the SCS for eastern Washington. This is not the only storm pattern that can occur. It is the storm pattern that was designated in an era when sizing conveyance system components (pipes, culverts, channels, and bridges) was a primary consideration and using that storm type produced the maximum peak flow rate.
- Long-duration storm (72-hour), intended to represent a winter or spring rainfall.

### **Review of the Short- and Long-Duration Design Storms**

The design storms (short-duration and long-duration) developed by MGS Engineering Consultants appear appropriate in temporal pattern. The short-duration and SCS Type II storms hyetographs are common patterns used in arid regions. They are patterns characterized by intense rainfall over relatively short periods within their duration.

The rainfall distributions of the four regional long-duration storm hyetographs do not appear like the majority of the 57 gauged precipitation events used to create the four hyetographs. The gauged multiple peaks appear random. They vary in relative size from small to large, large to small, and sometimes similar. The spacing between peaks varies significantly. From a macro pattern perspective, the long-duration storm hyetographs appear appropriate, but implementation is a concern. Event-based runoff modeling is time dependent; thus hyetograph shape is an important parameter.

The design storms developed by MGS Engineering Consultants appear appropriate in intensities. The precipitation maps and adjustment equations are reasonable.

### **Identification of Best Rainfall-Runoff Modeling Approaches for Eastern Washington**

There are a variety of computational methods available for computing runoff volumes and peak flow rates. Literature other than the work prepared by and cited by MGS Engineering Consultants appears nonexistent for arid region long-duration storms. As MGS Engineering Consultants concluded: “Accuracy of uncalibrated runoff estimation methods is generally poor for undeveloped sites in arid and semiarid environments. Without runoff data for verification, it is not possible to say which of the off-the-shelf runoff estimation methods would likely yield the more accurate results.”

Potential methods are Exponential Loss, Green-Ampt, Holtan, Initial Abstraction and Uniform Loss Rate, Soil Moisture Accounting, Hydrological Simulation Program–Fortran (HSPF), Soil Conservation Service (SCS) curve number equations, Rational Method, and Regression Equations. Many of these methods could be appropriate for long-duration runoff modeling if calibrated. MGS Engineering Consultants recommended: “The selection of runoff estimation methods should be made from commonly used methods that are readily available in computer programs for computation of runoff hydrographs.”

The above list of commonly used methods is broader than what may be commonly used by designers who are not hydrologic specialists. The methods most commonly used by regulatory agencies, design professionals, and software vendors are the SCS curve number equations, Rational Method, and Regression Equations. Only commonly used methods should be considered until quality data can be collected and rainfall-runoff calibration efforts performed.

With commonly used methods, the expertise of regulatory agencies, design professionals, and software vendors offer the best opportunity to use reasonable input values and produce reasonable output. Thus even though not technically calibrated, results that meet the standard of care for the industry are more likely using common uncalibrated methods than uncommon uncalibrated methods.

Of the three commonly used methods listed above (SCS curve number equations, Rational Method, and Regression Equations), only the SCS curve number equations are recommended for computing flow rates and runoff volumes for long-duration storms. The Rational Method is a good method for computing peak flow rates of small urban basins but has no capability to determine reasonable hydrographs and runoff volumes. Regression Equations require quality-measured data to create meaningful regression equations, but necessary data are lacking; peak flow rate determination is the common use of regression equations as runoff volume regression equations appear nonexistent.

The SCS Method is commonly used for small and large basins, though method origins are from large rural basins. The engineering community has experience implementing this method.

### **Discussion and Recommendation of Modified SCS Modeling Approach**

#### ***Short-Duration Storm (3-Hour) and SCS Type II Storm (24-Hour)***

The short-duration 3-hour storm and the SCS Type II 24-hour storm hyetographs can be directly modeled by readily available hydrologic modeling software and produce intended results.

#### ***Long-Duration Storm (72-Hour)***

The multipeak long-duration storm can also be directly modeled by readily available hydrologic modeling software, but does not necessarily produce intended results. NRCS staff has verbally stated that the SCS Method should not be applied to multipeak hyetographs. The caution may have been due merely to an unintended use or due to possible computational inaccuracies, but the latter appears to be the case.

With this limitation, another approach is necessary to model the long-duration storm hyetographs. Two key characteristics are apparent from the multipeak long-duration hyetographs.

- The first portion of the four regional hyetographs is small compared to the second portion. The first portion of the hyetograph is 16% to 25% of the total hyetograph, depending on the climate region. For most eastern Washington 72-hour precipitation amounts, the precipitation amount in the first portion hyetograph is diminutive.
- The period of no precipitation between the end of the first portion and beginning of the second portion of the hyetograph ranges from about 12 to 18 hours, depending on the climate region.

These two characteristics result in hydrographs that have no flow for the entire time between the two hyetographs and sometimes no flow during the first hyetograph. This means there is no compelling reason to directly model the first portion.

If only the second portion needs to be modeled, it may be possible to substitute another standard storm distribution: the SCS Type IA storm pattern of the coastal region of the state where winter rainfall originates. [Figure 4.19: Standard and Regional Storm Distribution Curves on a Unit Basis](#) shows only the second portion of the hyetographs for the four regional long-duration storms as cumulative precipitation and the SCS Type IA and Type II 24-hour storms in order to make a visual comparison.

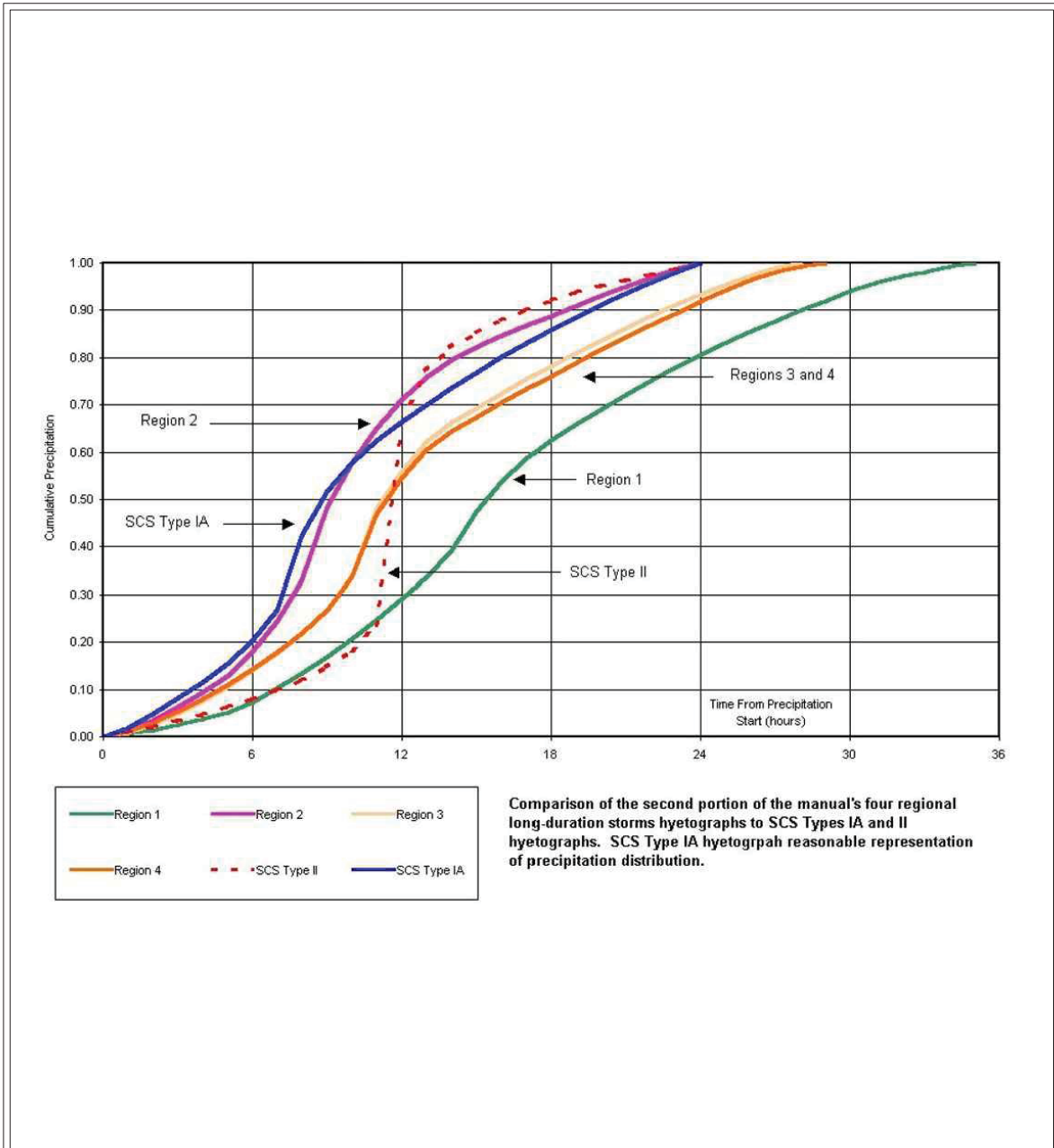
The Type IA storm is similar in shape to the second portion of all four regional long-duration storms. With this similarity, the Type IA may produce acceptable results without the added complexity. Its 24-hour duration allows for easy use of the built-in storm pattern feature of most SCS Method software. This reduces potential for computational errors due to incorrect implementation of unique duration hyetographs. Actual duration analysis provides computations that more directly reflect the second portion of the long-duration storm hyetographs, but those durations are not precise, they are statistical representations.

[Table 4.21: Comparisons to the Type IA Storm](#) provides key comparisons to the Type IA storm.

**Table 4.21: Comparisons to the Type IA Storm**

Second Portion of Long-Duration Hyetograph	Climate Region 1	Climate Region 2	Climate Region 3	Climate Region 4
Duration (hours)	35	24	28	29
Duration as Ratio of 24 Hours	1.46	1.00	1.16	1.21
Precipitation as Ratio of 24-Hour Precipitation	1.16	1.00	1.06	1.07

**Figure 4.19: Standard and Regional Storm Distribution Curves on a Unit Basis**



DEPARTMENT OF  
**ECOLOGY**  
State of Washington

## Standard and Regional Storm Distribution Curves on a Unit Basis

Revised September 2004

Please see <http://www.ecy.wa.gov/copyright.html> for copyright notice including permissions, limitation of liability, and disclaimer.

Climate Region 1 could be considered for 35-hour duration and 1.16 x 24-hour precipitation storm analysis. 16% more precipitation spread over 46% more time should produce less peak flow but more runoff volume than the Type IA storm. Many of the differences compared to the Type IA storm is in the waning hours of the hyetograph, thus would have less impact than might be expected. The second portions of the long-duration hyetographs for Climate Regions 2, 3, and 4 show no or only minor variation from SCS Type IA 24-hour storm; thus use of 24-hour storm is sufficiently accurate.

### ***Short-Duration Storm (3-Hour) and SCS Type II Storm (24-Hour)***

Modeling of the short-duration 3-hour storm and the SCS Type II 24-hour storm are to be per standard methods for those hyetographs.

### **Long-Duration Storm (72-Hour)**

The recommended approach for modeling the long-duration storm is as follows.

- Rainfall Modeling:

Emulate only the second portion of the long-duration storm hyetograph, but account for the first portion by adjusting antecedent moisture conditions.

- Rainfall Distribution:

Use the SCS Type IA 24-hour storm. This provides the simplest modeling approach and reduces the chance for error by implementing a nonstandard hyetograph. If an agency or local jurisdiction prefers the long-duration distributions, the second portion of the long-duration storm hyetograph can be implemented instead.

- Rainfall Intensity:

Use 24-hour intensity if using the SCS Type IA storm. If using the second portion of the long-duration storm hyetograph, use the precipitation ratio in [Table 4.21: Comparisons to the Type IA Storm](#).

- Curve Numbers:

Adjust curve numbers to account for saturation conditions due to first portion of hyetograph that is not directly modeled. Engineering analysis and judgment is needed for curve number adjustment depending on soil characteristics, surface conditions, and first-portion precipitation amount.

### **Sensitivity Analysis**

The primary concern regarding the SCS Method that arose in this study effort was the implementation of the multipeak hyetographs. To test the concern, the Hydrologic Engineering Center, Hydrologic Modeling System (HEC-HMS) was used to compute hydrographs. Three 25-year event hyetographs were modeled for an 8-acre basin with four basin coverage conditions.

For the 72-hour storm, as the initial loss rate decreased, runoff was generated earlier in the second hyetograph than in the SCS Type IA and second-portion only storm hyetographs. This means there was less initial abstraction (loss) computed in the more critical portion of the 72-hour hyetograph than the other storms. This is counterintuitive as the bulk of the 0.55 inches first-portion hyetograph

rainfall occurs 24 hours prior to the start of the second hyetograph, thus there should be opportunity for the entire initial loss to occur again at the start of the second hyetograph.

This initial loss computational difference and the impact it may have on second-portion hydrograph flow rates supports the NRCS contention regarding the modeling of multipeak hyetographs. The peak flow rates computed in the multipeak long-duration 72-hour storm did not match well with the peak flow rates computed from the other two hyetographs.

### **Further Recommendations**

A future effort of rainfall-runoff data collection and modeling correlation should be undertaken. This will improve the best available science beyond what exists today. Precipitation gauges that can measure in small time increments should be placed within drainage basins where runoff flows can be measured in similar small time increments. To be effective, this data collection effort should include broad ranges of drainage basins based on total annual precipitation, elevation, grades, soils types, development types, and degree of development.

Upon storm type segregation, further data analysis should include determination of effective modeling parameters such as lag times and SCS curve numbers and comparing them to values commonly used.



## Appendix 4-B: Historical Storms Used to Develop Design Storms in Eastern Washington

### 4.B.1 Long-Duration General Storms

**Table 4.22: Long-Duration Storms for Climate Region 1 – Cascade Mountains**

Precipitation Station	Storm Date	Precipitation 24-Hour (in)	Precipitation 72-Hour (in)
Carson Fish Hatch	9-Dec-1987	6.20	7.90
Diablo Dam	24-Oct-1945	6.42	9.23
Diablo Dam	9-Feb-1951	6.47	12.99
Diablo Dam	16-Feb-1949	8.12	9.64
Easton	8-Feb-1996	4.10	8.90
Easton	22-Nov-1990	6.40	10.20
Glenwood	28-Dec-1998	3.70	4.70
Glenwood	27-Oct-1994	3.80	4.10
Hood River Exp Station	6-Jan-1948	3.33	4.53
Lake Wenatchee	9-Jan-1990	5.30	7.60
Lucerne 2NNW	19-Nov-1962	3.05	3.45
Lucerne 2NNW	1-Dec-1975	3.17	5.99
Mazama	12-Jan-1980	3.20	3.62
Mazama	27-Feb-1972	3.80	5.97
Mount Adams RS	13-Jan-1973	6.00	11.39
Satus Pass	24-Nov-1960	3.12	4.46
Satus Pass	13-Dec-1977	3.30	5.02
Satus Pass	15-Jan-1974	3.60	6.05
Stehekin 4NW	23-Jan-1982	5.00	6.80
Stevens Pass	3-Dec-1982	6.50	7.40
Underwood	11-Dec-1946	4.04	7.27
Source: Ecology Water Resources Program, Dam Safety Office.			

**Table 4.23: Long-Duration Storms for Climate  
Region 2 – Central Basin**

Precipitation Station	Storm Date	Precipitation 24-Hour (in)	Precipitation 72-Hour (in)
Centerville	19-Jan-1953	2.36	2.76
Chief Joe Dam	18-Sep-1986	1.50	1.70
Coulee Dam 1SW	28-May-1948	1.66	1.74
Ellensburg	4-Dec-1974	1.30	2.00
Harrington 1NW	23-Dec-1966	1.12	1.28
Harrington 4ENE	25-Sep-1948	1.51	1.65
Harrington 4ENE	21-Sep-1945	1.52	2.10
Lind 3NE	25-Jun-1942	1.53	1.77
McNary Dam	2-Oct-1957	3.15	3.17
Naches 10NW	14-Jan-1956	1.43	1.60
Wenatchee	10-Dec-1987	1.77	1.82
Yakima	24-Dec-1964	1.40	2.83
Yakima	19-Nov-1996	1.40	1.57

Source: Ecology Water Resources Program, Dam Safety Office.

**Table 4.24: Long-Duration Storms for Climate  
Region 3 – Okanogan/Spokane/Palouse**

Precipitation Station	Storm Date	Precipitation 24-Hour (in)	Precipitation 72-Hour (in)
Colville Airport	16-Nov-1973	1.55	1.98
Dayton 9SE	2-Jan-1966	2.53	3.69
Dayton 9SE	22-Dec-1964	3.01	4.70
Dixie 4SE	23-Nov-1964	2.70	2.92
Moscow 5NE ID	9-Feb-1996	1.50	3.20
Moscow 5NE ID	11-Nov-1973	1.70	2.90

**Table 4.24: Long-Duration Storms for Climate  
Region 3 – Okanogan/Spokane/Palouse  
(continued)**

Precipitation Station	Storm Date	Precipitation 24-Hour (in)	Precipitation 72-Hour (in)
Moscow 5NE ID	23-Dec-1972	1.80	2.70
Ola ID	27-Dec-1996	3.10	5.00
Oroville	16-Nov-1950	1.96	2.04
Pullman 2NW	22-Nov-1961	1.96	2.52
Pullman 2NW	15-Sep-1947	2.10	2.60
Republic	27-May-1998	2.50	2.80
Spokane WSO AP	25-Nov-1960	1.41	1.86
Spokane WSO AP	13-Apr-2000	1.53	1.73
Spokane WSO AP	18-Dec-1951	1.58	1.67
Walla Walla WSO	14-Oct-1980	3.08	3.63
Whitman Mission	19-Nov-1996	2.00	2.40
Source: Ecology Water Resources Program, Dam Safety Office.			

**Table 4.25: Long-Duration Storms for Climate  
Region 4 – Northeastern Mountains and Blue  
Mountains**

Precipitation Station	Storm Date	Precipitation 24-Hour (in)	Precipitation 72-Hour (in)
Bonnars Ferry 1SW	18-Nov-1946	2.78	4.09
Boundary Switchyard	4-Jan-1989	2.30	2.50
Boundary Switchyard	15-Feb-1986	3.10	3.19
Coeur d'Alene RS	15-Jan-1974	1.90	3.70
Colville Airport	16-Nov-1973	1.55	1.98
Dayton 9SE	2-Jan-1966	2.53	3.69
Dayton 9SE	22-Dec-1964	3.01	4.70

**Table 4.25: Long-Duration Storms for Climate Region 4 – Northeastern Mountains and Blue Mountains (continued)**

Precipitation Station	Storm Date	Precipitation 24-Hour (in)	Precipitation 72-Hour (in)
Dworshak Fish Hatch ID	2-Dec-1977	2.30	2.40
Moscow 5NE ID	9-Feb-1996	1.50	3.20
Moscow 5NE ID	11-Nov-1973	1.70	2.90
Moscow 5NE ID	23-Dec-1972	1.80	2.70
Northport	27-May-1998	2.40	2.80
Ola ID	27-Dec-1996	3.10	5.00
Plummer 3WSW ID	25-Dec-1980	2.10	2.80
Pullman 2NW	22-Nov-1961	1.96	2.52
Pullman 2NW	15-Sep-1947	2.10	2.60
Source: Ecology Water Resources Program, Dam Safety Office.			

#### 4.B.2 Short-Duration General Storms

**Table 4.26: Short-Duration Storms for All Climate Regions**

Precipitation Station	Climate Region	Storm Date	Precip. 1-Hour (in)	Precip. 2-Hour (in)
Diablo Dam	1	20-Jul-1992	0.80	1.10
Easton	1	26-Aug-1983	1.80	1.80
Lake Wenatchee	1	11-Feb-1985	0.90	1.10
Mazama	1	16-Jul-1985	1.00	1.10
Stevens Pass	1	2-Jun-1998	1.00	1.00
Chief Joe Dam	2	23-Jul-1992	0.70	1.00
Chief Joe Dam	2	9-Jul-1993	1.10	1.10
Ellensburg	2	12-May-1943	0.31	0.62
Lind 3NE	2	22-Jul-1993	1.30	1.40
Methow	2	17-Jun-1950	0.89	0.89

**Table 4.26: Short-Duration Storms for All Climate Regions (continued)**

Precipitation Station	Climate Region	Storm Date	Precip. 1-Hour (in)	Precip. 2-Hour (in)
Methow	2	8-Jul-1958	1.33	1.33
Naches 10NW	2	5-May-1957	0.70	0.90
Naches 10NW	2	1-Aug-1984	0.80	0.80
Naches 10NW	2	7-Jul-1982	1.20	1.20
Sunnyside	2	7-Jun-1947	1.62	1.62
Wenatchee Exp Station	2	10-Aug-1952	1.29	1.29
Wilson Creek	2	24-Jul-1950	0.80	0.80
Wilson Creek	2	18-Jun-1950	1.50	1.50
Withrow 4WNW	2	14-Aug-1968	0.64	0.94
Yakima	2	18-Aug-1975	0.70	0.98
Chewelah	3	20-Jul-1983	0.90	1.00
Dayton 1WSW	3	8-Jul-1946	0.78	0.79
Dayton 1WSW	3	7-Jul-1978	1.20	1.20
Oroville	3	16-Jun-1947	1.19	1.25
Pomeroy	3	13-Sep-1966	1.12	1.12
Republic RS	3	10-Aug-1983	0.90	1.50
Republic RS	3	5-Jul-1958	1.10	1.10
Republic RS	3	9-Aug-1962	1.17	1.26
Walla Walla WSO	3	26-May-1971	1.64	1.75
Whitman Mission	3	5-Aug-1977	0.94	0.94
Boundary Switchyard	4	21-May-1981	0.90	1.10
Boundary Switchyard	4	23-May-1989	1.00	1.00
Colville	4	19-Jul-1950	0.92	1.00
Colville	4	6-Jul-1956	0.81	0.82
Colville	4	3-Jun-1999	1.00	1.90

**Table 4.26: Short-Duration Storms for All Climate Regions (continued)**

Precipitation Station	Climate Region	Storm Date	Precip. 1-Hour (in)	Precip. 2-Hour (in)
Dixie 4SE	4	7-Aug-1992	0.70	0.90
Northport	4	11-Jul-1998	1.10	1.10
Source: Ecology Water Resources Program, Dam Safety Office.				

## Appendix 4-C: Long-Duration Storm Hyetographs for Eastern Washington

### 4.C.1 Introduction

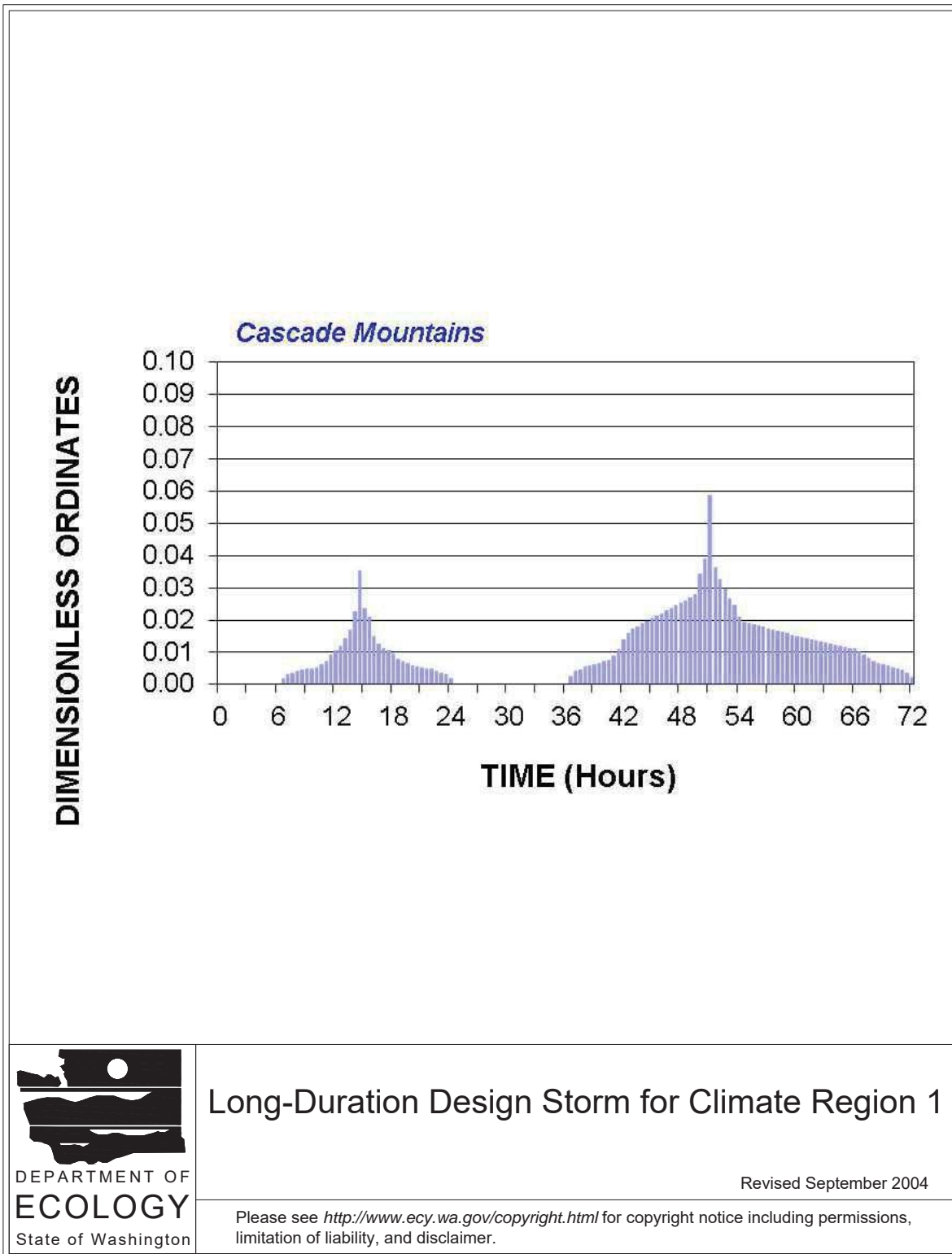
Graphical and tabular representations of the long-duration design storms developed by MGS Engineering Consultants are provided in [Figure 4.20: Long-Duration Design Storm for Climate Region 1](#) through [Figure 4.23: Long-Duration Design Storm for Climate Region 4](#) and [Table 4.27: 72-Hour Long-Duration Storm Hyetograph Values for Climate Region 1: Cascade Mountains](#) through [Table 4.30: 72-Hour Long-Duration Storm Hyetograph Values for Climate Region 4: Eastern Mountains](#).

**Note:** The 72-hour hyetographs are not unit hyetographs, but have maximum values equal to the ratio of the total 72-hour precipitation to the 24-hour precipitation.

**For more information:** See [Appendix 4-A: Background Information on Design Storms and Selected Modeling Methods](#) for additional information and limitations in applying these hyetographs.

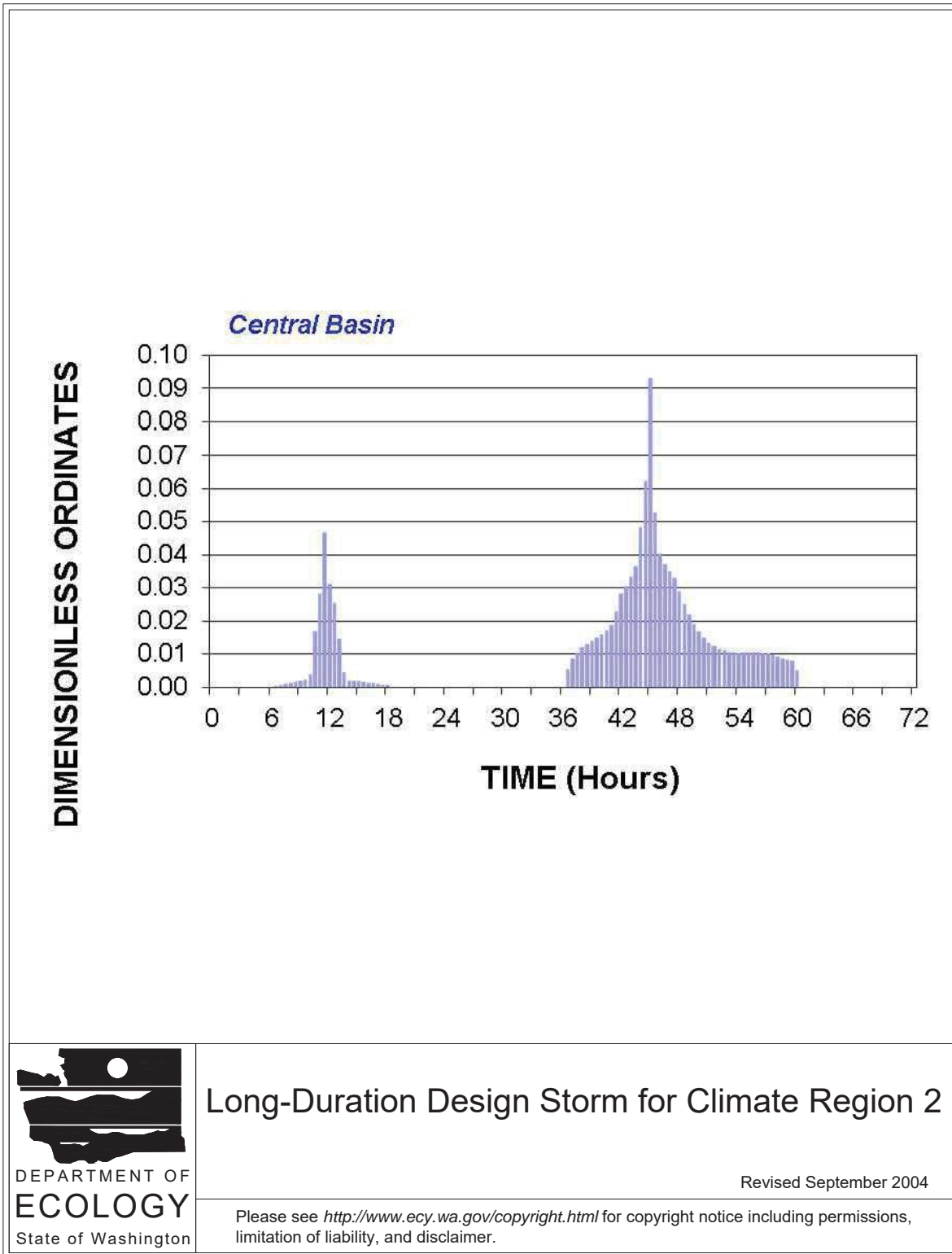
## 4.C.2 Long-Duration Design Storm Figures

Figure 4.20: Long-Duration Design Storm for Climate Region 1

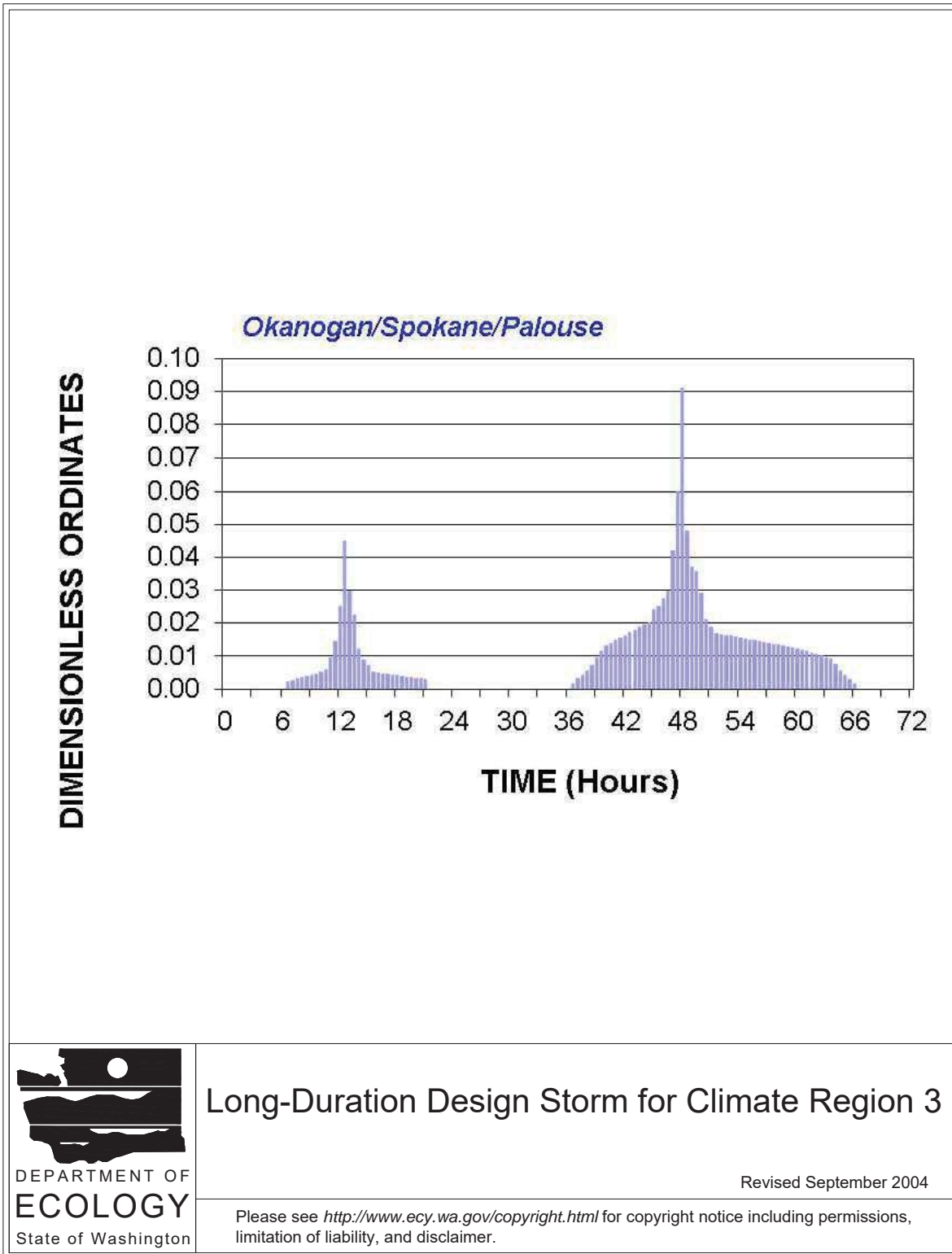




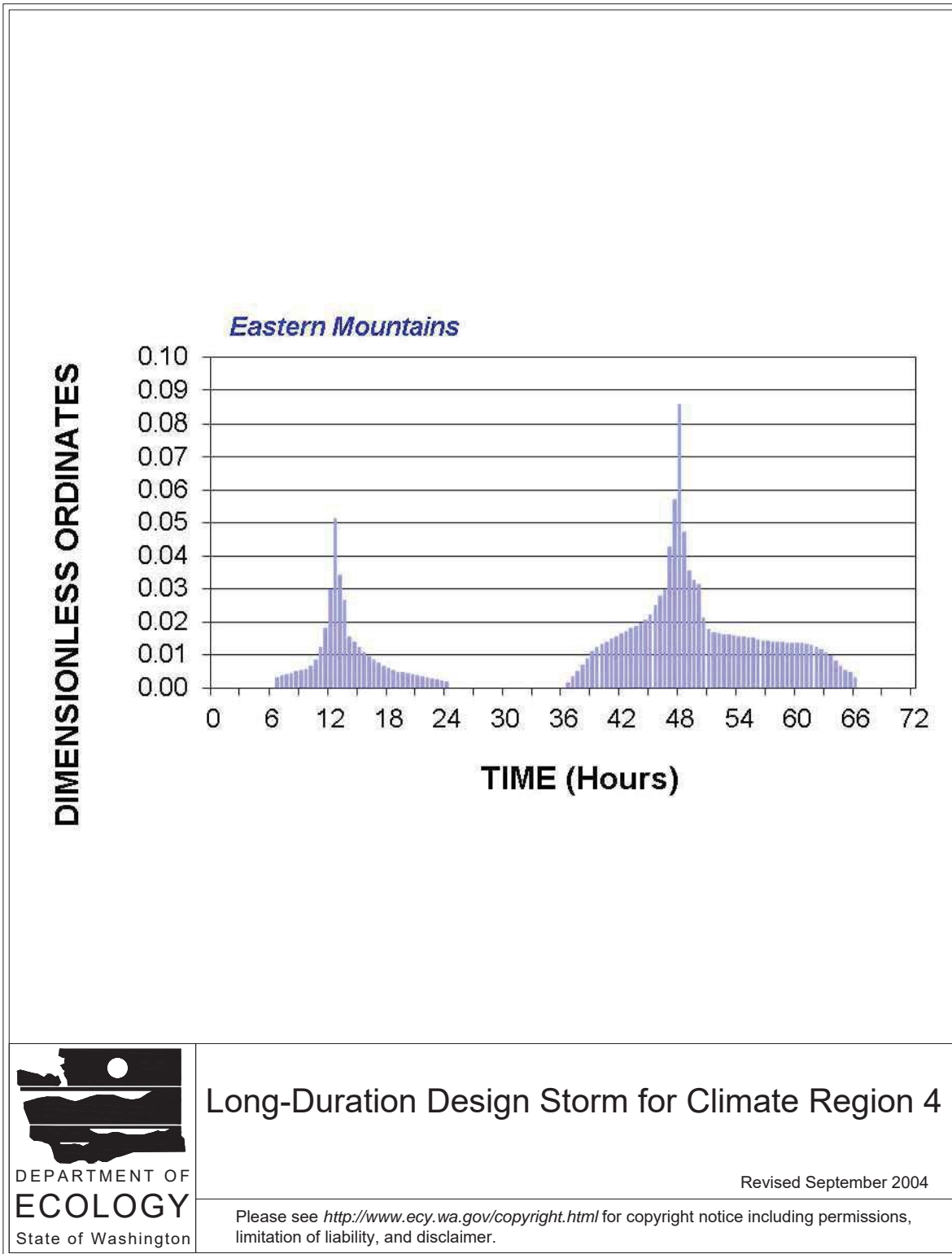
**Figure 4.21: Long-Duration Design Storm for Climate Region 2**



**Figure 4.22: Long-Duration Design Storm for Climate Region 3**



**Figure 4.23: Long-Duration Design Storm for Climate Region 4**



### 4.C.3 Climate Region 1: Cascade Mountains

Use 24-hour precipitation value to scale this storm hyetograph.

**Table 4.27: 72-Hour Long-Duration Storm Hyetograph Values for Climate Region 1: Cascade Mountains**

Time (hours)	Incremental Rainfall	Cumulative Rainfall	Time (hours)	Incremental Rainfall	Cumulative Rainfall
0.0	0.00000	0.00000	36.5	0.00277	0.33667
0.5	0.00000	0.00000	37.0	0.00423	0.34090
1.0	0.00000	0.00000	37.5	0.00467	0.34557
1.5	0.00000	0.00000	38.0	0.00550	0.35107
2.0	0.00000	0.00000	38.5	0.00590	0.35697
2.5	0.00000	0.00000	39.0	0.00630	0.36327
3.0	0.00000	0.00000	39.5	0.00670	0.36997
3.5	0.00000	0.00000	40.0	0.00723	0.37720
4.0	0.00000	0.00000	40.5	0.00760	0.38480
4.5	0.00000	0.00000	41.0	0.00907	0.39387
5.0	0.00000	0.00000	41.5	0.01116	0.40503
5.5	0.00000	0.00000	42.0	0.01387	0.41890
6.0	0.00000	0.00000	42.5	0.01600	0.43490
6.5	0.00179	0.00179	43.0	0.01740	0.45230
7.0	0.00321	0.00500	43.5	0.01820	0.47050
7.5	0.00370	0.00870	44.0	0.01900	0.48950
8.0	0.00420	0.01290	44.5	0.01980	0.50930
8.5	0.00470	0.01760	45.0	0.02060	0.52990
9.0	0.00490	0.02250	45.5	0.02140	0.55130
9.5	0.00510	0.02760	46.0	0.02220	0.57350
10.0	0.00530	0.03290	46.5	0.02300	0.59650
10.5	0.00634	0.03924	47.0	0.02380	0.62030
11.0	0.00740	0.04664	47.5	0.02460	0.64490
11.5	0.00920	0.05584	48.0	0.02550	0.67040
12.0	0.01080	0.06664	48.5	0.02620	0.69660

**Table 4.27: 72-Hour Long-Duration Storm Hyetograph Values for  
Climate Region 1: Cascade Mountains (continued)**

Time (hours)	Incremental Rainfall	Cumulative Rainfall	Time (hours)	Incremental Rainfall	Cumulative Rainfall
12.5	0.01214	0.07878	49.0	0.02720	0.72380
13.0	0.01424	0.09302	49.5	0.02820	0.75200
13.5	0.01712	0.11014	50.0	0.03445	0.78645
14.0	0.02288	0.13302	50.5	0.03920	0.82565
14.5	0.03540	0.16842	51.0	0.05880	0.88445
15.0	0.02360	0.19202	51.5	0.03652	0.92097
15.5	0.02101	0.21303	52.0	0.03280	0.95377
16.0	0.01499	0.22802	52.5	0.02980	0.98357
16.5	0.01279	0.24081	53.0	0.02680	1.01037
17.0	0.01144	0.25225	53.5	0.02484	1.03521
17.5	0.01070	0.26295	54.0	0.02116	1.05637
18.0	0.00960	0.27255	54.5	0.01943	1.07580
18.5	0.00814	0.28069	55.0	0.01910	1.09490
19.0	0.00730	0.28799	55.5	0.01870	1.11360
19.5	0.00657	0.29456	56.0	0.01830	1.13190
20.0	0.00598	0.30054	56.5	0.01790	1.14980
20.5	0.00551	0.30605	57.0	0.01750	1.16730
21.0	0.00516	0.31121	57.5	0.01710	1.18440
21.5	0.00494	0.31615	58.0	0.01670	1.20110
22.0	0.00485	0.32100	58.5	0.01630	1.21740
22.5	0.00420	0.32520	59.0	0.01590	1.23330
23.0	0.00370	0.32890	59.5	0.01550	1.24880
23.5	0.00320	0.33210	60.0	0.01510	1.26390
24.0	0.00180	0.33390	60.5	0.01470	1.27860
24.5	0.00000	0.33390	61.0	0.01430	1.29290
25.0	0.00000	0.33390	61.5	0.01390	1.30680
25.5	0.00000	0.33390	62.0	0.01360	1.32040

**Table 4.27: 72-Hour Long-Duration Storm Hyetograph Values for  
Climate Region 1: Cascade Mountains (continued)**

Time (hours)	Incremental Rainfall	Cumulative Rainfall	Time (hours)	Incremental Rainfall	Cumulative Rainfall
26.0	0.00000	0.33390	62.5	0.01330	1.33370
26.5	0.00000	0.33390	63.0	0.01300	1.34670
27.0	0.00000	0.33390	63.5	0.01270	1.35940
27.5	0.00000	0.33390	64.0	0.01240	1.37180
28.0	0.00000	0.33390	64.5	0.01210	1.38390
28.5	0.00000	0.33390	65.0	0.01180	1.39570
29.0	0.00000	0.33390	65.5	0.01150	1.40720
29.5	0.00000	0.33390	66.0	0.01120	1.41840
30.0	0.00000	0.33390	66.5	0.01020	1.42860
30.5	0.00000	0.33390	67.0	0.00920	1.43780
31.0	0.00000	0.33390	67.5	0.00820	1.44600
31.5	0.00000	0.33390	68.0	0.00734	1.45334
32.0	0.00000	0.33390	68.5	0.00675	1.46009
32.5	0.00000	0.33390	69.0	0.00630	1.46639
33.0	0.00000	0.33390	69.5	0.00585	1.47224
33.5	0.00000	0.33390	70.0	0.00540	1.47764
34.0	0.00000	0.33390	70.5	0.00495	1.48259
34.5	0.00000	0.33390	71.0	0.00450	1.48709
35.0	0.00000	0.33390	71.5	0.00350	1.49059
35.5	0.00000	0.33390	72.0	0.00225	1.49284
36.0	0.00000	0.33390			

#### **4.C.4 Climate Region 2: Central Basin**

Use 24-hour precipitation value to scale this storm hyetograph.

**Table 4.28: 72-Hour Long-Duration Storm Hyetograph Values for  
Climate Region 2: Central Basin**

Time (hours)	Incremental Rainfall	Cumulative Rainfall	Time (hours)	Incremental Rainfall	Cumulative Rainfall
0.0	0.00000	0.00000	36.5	0.00544	0.19701
0.5	0.00000	0.00000	37.0	0.00856	0.20557
1.0	0.00000	0.00000	37.5	0.01000	0.21557
1.5	0.00000	0.00000	38.0	0.01200	0.22757
2.0	0.00000	0.00000	38.5	0.01300	0.24057
2.5	0.00000	0.00000	39.0	0.01400	0.25457
3.0	0.00000	0.00000	39.5	0.01500	0.26957
3.5	0.00000	0.00000	40.0	0.01600	0.28557
4.0	0.00000	0.00000	40.5	0.01700	0.30257
4.5	0.00000	0.00000	41.0	0.01869	0.32126
5.0	0.00000	0.00000	41.5	0.02281	0.34407
5.5	0.00000	0.00000	42.0	0.02832	0.37239
6.0	0.00000	0.00000	42.5	0.03050	0.40289
6.5	0.00030	0.00030	43.0	0.03350	0.43639
7.0	0.00060	0.00090	43.5	0.03650	0.47289
7.5	0.00090	0.00180	44.0	0.04842	0.52131
8.0	0.00120	0.00300	44.5	0.06220	0.58351
8.5	0.00150	0.00450	45.0	0.09330	0.67681
9.0	0.00180	0.00630	45.5	0.05275	0.72956
9.5	0.00210	0.00840	46.0	0.04025	0.76981
10.0	0.00394	0.01234	46.5	0.03717	0.80698
10.5	0.01669	0.02903	47.0	0.03483	0.84181
11.0	0.02831	0.05734	47.5	0.03307	0.87488
11.5	0.04680	0.10414	48.0	0.02893	0.90381
12.0	0.03120	0.13534	48.5	0.02519	0.92900
12.5	0.02549	0.16083	49.0	0.02189	0.95089
13.0	0.01451	0.17534	49.5	0.01906	0.96995

**Table 4.28: 72-Hour Long-Duration Storm Hyetograph Values for  
Climate Region 2: Central Basin (continued)**

Time (hours)	Incremental Rainfall	Cumulative Rainfall	Time (hours)	Incremental Rainfall	Cumulative Rainfall
13.5	0.00445	0.17979	50.0	0.01670	0.98665
14.0	0.00202	0.18181	50.5	0.01480	1.00145
14.5	0.00192	0.18373	51.0	0.01336	1.01481
15.0	0.00172	0.18545	51.5	0.01234	1.02715
15.5	0.00152	0.18697	52.0	0.01156	1.03871
16.0	0.00132	0.18829	52.5	0.01096	1.04967
16.5	0.00112	0.18941	53.0	0.01054	1.06021
17.0	0.00092	0.19033	53.5	0.01032	1.07053
17.5	0.00072	0.19105	54.0	0.01028	1.08081
18.0	0.00052	0.19157	54.5	0.01038	1.09119
18.5	0.00000	0.19157	55.0	0.01046	1.10165
19.0	0.00000	0.19157	55.5	0.01046	1.11211
19.5	0.00000	0.19157	56.0	0.01040	1.12251
20.0	0.00000	0.19157	56.5	0.01025	1.13276
20.5	0.00000	0.19157	57.0	0.01004	1.14280
21.0	0.00000	0.19157	57.5	0.00974	1.15254
21.5	0.00000	0.19157	58.0	0.00926	1.16180
22.0	0.00000	0.19157	58.5	0.00868	1.17048
22.5	0.00000	0.19157	59.0	0.00832	1.17880
23.0	0.00000	0.19157	59.5	0.00781	1.18661
23.5	0.00000	0.19157	60.0	0.00500	1.19161
24.0	0.00000	0.19157	60.5	0.00000	1.19161
24.5	0.00000	0.19157	61.0	0.00000	1.19161
25.0	0.00000	0.19157	61.5	0.00000	1.19161
25.5	0.00000	0.19157	62.0	0.00000	1.19161
26.0	0.00000	0.19157	62.5	0.00000	1.19161
26.5	0.00000	0.19157	63.0	0.00000	1.19161



**Table 4.28: 72-Hour Long-Duration Storm Hyetograph Values for  
Climate Region 2: Central Basin (continued)**

Time (hours)	Incremental Rainfall	Cumulative Rainfall	Time (hours)	Incremental Rainfall	Cumulative Rainfall
27.0	0.00000	0.19157	63.5	0.00000	1.19161
27.5	0.00000	0.19157	64.0	0.00000	1.19161
28.0	0.00000	0.19157	64.5	0.00000	1.19161
28.5	0.00000	0.19157	65.0	0.00000	1.19161
29.0	0.00000	0.19157	65.5	0.00000	1.19161
29.5	0.00000	0.19157	66.0	0.00000	1.19161
30.0	0.00000	0.19157	66.5	0.00000	1.19161
30.5	0.00000	0.19157	67.0	0.00000	1.19161
31.0	0.00000	0.19157	67.5	0.00000	1.19161
31.5	0.00000	0.19157	68.0	0.00000	1.19161
32.0	0.00000	0.19157	68.5	0.00000	1.19161
32.5	0.00000	0.19157	69.0	0.00000	1.19161
33.0	0.00000	0.19157	69.5	0.00000	1.19161
33.5	0.00000	0.19157	70.0	0.00000	1.19161
34.0	0.00000	0.19157	70.5	0.00000	1.19161
34.5	0.00000	0.19157	71.0	0.00000	1.19161
35.0	0.00000	0.19157	71.5	0.00000	1.19161
35.5	0.00000	0.19157	72.0	0.00000	1.19161
36.0	0.00000	0.19157			

### **4.C.5 Climate Region 3: Okanogan, Spokane, Palouse**

Use 24-hour precipitation value to scale this storm hyetograph.

**Table 4.29: 72-Hour Long-Duration Storm Hyetograph Values for  
Climate Region 3: Okanogan, Spokane, Palouse**

Time (hours)	Incremental Rainfall	Cumulative Rainfall	Time (hours)	Incremental Rainfall	Cumulative Rainfall
0.0	0.00000	0.00000	36.5	0.00180	0.26343
0.5	0.00000	0.00000	37.0	0.00320	0.26663
1.0	0.00000	0.00000	37.5	0.00437	0.27100
1.5	0.00000	0.00000	38.0	0.00563	0.27663
2.0	0.00000	0.00000	38.5	0.00722	0.28385
2.5	0.00000	0.00000	39.0	0.00978	0.29363
3.0	0.00000	0.00000	39.5	0.01150	0.30513
3.5	0.00000	0.00000	40.0	0.01340	0.31853
4.0	0.00000	0.00000	40.5	0.01400	0.33253
4.5	0.00000	0.00000	41.0	0.01480	0.34733
5.0	0.00000	0.00000	41.5	0.01560	0.36293
5.5	0.00000	0.00000	42.0	0.01640	0.37933
6.0	0.00000	0.00000	42.5	0.01720	0.39653
6.5	0.00240	0.00240	43.0	0.01800	0.41453
7.0	0.00280	0.00520	43.5	0.01880	0.43333
7.5	0.00320	0.00840	44.0	0.01960	0.45293
8.0	0.00360	0.01200	44.5	0.02040	0.47333
8.5	0.00403	0.01603	45.0	0.02430	0.49763
9.0	0.00440	0.02043	45.5	0.02534	0.52297
9.5	0.00480	0.02523	46.0	0.02766	0.55063
10.0	0.00520	0.03043	46.5	0.03000	0.58063
10.5	0.00600	0.03643	47.0	0.04200	0.62263
11.0	0.00968	0.04611	47.5	0.06000	0.68263
11.5	0.01476	0.06087	48.0	0.09100	0.77363
12.0	0.02524	0.08611	48.5	0.04801	0.82164
12.5	0.04500	0.13111	49.0	0.03700	0.85864
13.0	0.03000	0.16111	49.5	0.03568	0.89432

**Table 4.29: 72-Hour Long-Duration Storm Hyetograph Values for  
Climate Region 3: Okanogan, Spokane, Palouse (continued)**

Time (hours)	Incremental Rainfall	Cumulative Rainfall	Time (hours)	Incremental Rainfall	Cumulative Rainfall
13.5	0.02267	0.18378	50.0	0.02932	0.92364
14.0	0.01233	0.19611	50.5	0.02114	0.94478
14.5	0.00901	0.20512	51.0	0.01900	0.96378
15.0	0.00731	0.21243	51.5	0.01680	0.98058
15.5	0.00520	0.21763	52.0	0.01660	0.99718
16.0	0.00500	0.22263	52.5	0.01640	1.01358
16.5	0.00480	0.22743	53.0	0.01620	1.02978
17.0	0.00460	0.23203	53.5	0.01600	1.04578
17.5	0.00440	0.23643	54.0	0.01570	1.06148
18.0	0.00420	0.24063	54.5	0.01540	1.07688
18.5	0.00400	0.24463	55.0	0.01510	1.09198
19.0	0.00380	0.24843	55.5	0.01480	1.10678
19.5	0.00360	0.25203	56.0	0.01450	1.12128
20.0	0.00340	0.25543	56.5	0.01420	1.13548
20.5	0.00320	0.25863	57.0	0.01390	1.14938
21.0	0.00300	0.26163	57.5	0.01379	1.16317
21.5	0.00000	0.26163	58.0	0.01361	1.17678
22.0	0.00000	0.26163	58.5	0.01338	1.19016
22.5	0.00000	0.26163	59.0	0.01310	1.20326
23.0	0.00000	0.26163	59.5	0.01276	1.21602
23.5	0.00000	0.26163	60.0	0.01236	1.22838
24.0	0.00000	0.26163	60.5	0.01192	1.24030
24.5	0.00000	0.26163	61.0	0.01148	1.25178
25.0	0.00000	0.26163	61.5	0.01104	1.26282
25.5	0.00000	0.26163	62.0	0.01061	1.27343
26.0	0.00000	0.26163	62.5	0.01018	1.28361
26.5	0.00000	0.26163	63.0	0.00976	1.29337

**Table 4.29: 72-Hour Long-Duration Storm Hyetograph Values for  
Climate Region 3: Okanogan, Spokane, Palouse (continued)**

Time (hours)	Incremental Rainfall	Cumulative Rainfall	Time (hours)	Incremental Rainfall	Cumulative Rainfall
27.0	0.00000	0.26163	63.5	0.00918	1.30255
27.5	0.00000	0.26163	64.0	0.00782	1.31037
28.0	0.00000	0.26163	64.5	0.00579	1.31616
28.5	0.00000	0.26163	65.0	0.00421	1.32037
29.0	0.00000	0.26163	65.5	0.00315	1.32352
29.5	0.00000	0.26163	66.0	0.00185	1.32537
30.0	0.00000	0.26163	66.5	0.00000	1.32537
30.5	0.00000	0.26163	67.0	0.00000	1.32537
31.0	0.00000	0.26163	67.5	0.00000	1.32537
31.5	0.00000	0.26163	68.0	0.00000	1.32537
32.0	0.00000	0.26163	68.5	0.00000	1.32537
32.5	0.00000	0.26163	69.0	0.00000	1.32537
33.0	0.00000	0.26163	69.5	0.00000	1.32537
33.5	0.00000	0.26163	70.0	0.00000	1.32537
34.0	0.00000	0.26163	70.5	0.00000	1.32537
34.5	0.00000	0.26163	71.0	0.00000	1.32537
35.0	0.00000	0.26163	71.5	0.00000	1.32537
35.5	0.00000	0.26163	72.0	0.00000	1.32537
36.0	0.00000	0.26163			

#### **4.C.6 Climate Region 4: Eastern Mountains**

Use 24-hour precipitation value to scale this storm hyetograph.

**Table 4.30: 72-Hour Long-Duration Storm Hyetograph Values for  
Climate Region 4: Eastern Mountains**

Time (hours)	Incremental Rainfall	Cumulative Rainfall	Time (hours)	Incremental Rainfall	Cumulative Rainfall
0.0	0.00000	0.00000	36.5	0.00167	0.35486
0.5	0.00000	0.00000	37.0	0.00333	0.35819
1.0	0.00000	0.00000	37.5	0.00510	0.36329
1.5	0.00000	0.00000	38.0	0.00690	0.37019
2.0	0.00000	0.00000	38.5	0.00879	0.37898
2.5	0.00000	0.00000	39.0	0.01121	0.39019
3.0	0.00000	0.00000	39.5	0.01240	0.40259
3.5	0.00000	0.00000	40.0	0.01320	0.41579
4.0	0.00000	0.00000	40.5	0.01400	0.42979
4.5	0.00000	0.00000	41.0	0.01480	0.44459
5.0	0.00000	0.00000	41.5	0.01560	0.46019
5.5	0.00000	0.00000	42.0	0.01640	0.47659
6.0	0.00000	0.00000	42.5	0.01720	0.49379
6.5	0.00300	0.00300	43.0	0.01800	0.51179
7.0	0.00390	0.00690	43.5	0.01880	0.53059
7.5	0.00423	0.01113	44.0	0.01960	0.55019
8.0	0.00456	0.01569	44.5	0.02050	0.57069
8.5	0.00490	0.02059	45.0	0.02230	0.59299
9.0	0.00523	0.02582	45.5	0.02500	0.61799
9.5	0.00556	0.03138	46.0	0.02800	0.64599
10.0	0.00650	0.03788	46.5	0.03000	0.67599
10.5	0.00868	0.04656	47.0	0.04295	0.71894
11.0	0.01246	0.05902	47.5	0.05720	0.77614
11.5	0.01824	0.07726	48.0	0.08580	0.86194
12.0	0.02976	0.10702	48.5	0.04751	0.90945
12.5	0.05160	0.15862	49.0	0.03549	0.94494
13.0	0.03440	0.19302	49.5	0.03265	0.97759

**Table 4.30: 72-Hour Long-Duration Storm Hyetograph Values for  
Climate Region 4: Eastern Mountains (continued)**

Time (hours)	Incremental Rainfall	Cumulative Rainfall	Time (hours)	Incremental Rainfall	Cumulative Rainfall
13.5	0.02655	0.21957	50.0	0.03135	1.00894
14.0	0.01545	0.23502	50.5	0.02140	1.03034
14.5	0.01388	0.24890	51.0	0.01790	1.04824
15.0	0.01232	0.26122	51.5	0.01670	1.06494
15.5	0.01089	0.27211	52.0	0.01650	1.08144
16.0	0.00961	0.28173	52.5	0.01630	1.09774
16.5	0.00848	0.29020	53.0	0.01610	1.11384
17.0	0.00748	0.29768	53.5	0.01590	1.12974
17.5	0.00661	0.30430	54.0	0.01570	1.14544
18.0	0.00590	0.31019	54.5	0.01550	1.16094
18.5	0.00532	0.31552	55.0	0.01535	1.17629
19.0	0.00489	0.32040	55.5	0.01508	1.19137
19.5	0.00459	0.32499	56.0	0.01471	1.20608
20.0	0.00430	0.32930	56.5	0.01442	1.22050
20.5	0.00401	0.33330	57.0	0.01421	1.23471
21.0	0.00372	0.33702	57.5	0.01407	1.24878
21.5	0.00343	0.34045	58.0	0.01395	1.26273
22.0	0.00313	0.34358	58.5	0.01385	1.27658
22.5	0.00284	0.34642	59.0	0.01377	1.29035
23.0	0.00255	0.34897	59.5	0.01370	1.30405
23.5	0.00226	0.35123	60.0	0.01365	1.31770
24.0	0.00197	0.35319	60.5	0.01358	1.33128
24.5	0.00000	0.35319	61.0	0.01338	1.34466
25.0	0.00000	0.35319	61.5	0.01300	1.35766
25.5	0.00000	0.35319	62.0	0.01245	1.37011
26.0	0.00000	0.35319	62.5	0.01174	1.38185
26.5	0.00000	0.35319	63.0	0.01085	1.39270

**Table 4.30: 72-Hour Long-Duration Storm Hyetograph Values for  
Climate Region 4: Eastern Mountains (continued)**

Time (hours)	Incremental Rainfall	Cumulative Rainfall	Time (hours)	Incremental Rainfall	Cumulative Rainfall
27.0	0.00000	0.35319	63.5	0.00975	1.40245
27.5	0.00000	0.35319	64.0	0.00825	1.41070
28.0	0.00000	0.35319	64.5	0.00654	1.41724
28.5	0.00000	0.35319	65.0	0.00546	1.42270
29.0	0.00000	0.35319	65.5	0.00484	1.42754
29.5	0.00000	0.35319	66.0	0.00316	1.43070
30.0	0.00000	0.35319	66.5	0.00000	1.43070
30.5	0.00000	0.35319	67.0	0.00000	1.43070
31.0	0.00000	0.35319	67.5	0.00000	1.43070
31.5	0.00000	0.35319	68.0	0.00000	1.43070
32.0	0.00000	0.35319	68.5	0.00000	1.43070
32.5	0.00000	0.35319	69.0	0.00000	1.43070
33.0	0.00000	0.35319	69.5	0.00000	1.43070
33.5	0.00000	0.35319	70.0	0.00000	1.43070
34.0	0.00000	0.35319	70.5	0.00000	1.43070
34.5	0.00000	0.35319	71.0	0.00000	1.43070
35.0	0.00000	0.35319	71.5	0.00000	1.43070
35.5	0.00000	0.35319	72.0	0.00000	1.43070
36.0	0.00000	0.35319			

*This page has been intentionally left blank for double-sided printing.*



## Appendix 4-D: Design Storm Hyetographs

### 4.D.1 Introduction

This appendix includes the Soil Conservation Service (SCS) Type IA and SCS Type II hyetograph values ([Table 4.31: SCS Type IA Storm Hyetograph Values](#) and [Table 4.32: SCS Type II Storm Hyetograph Values](#)). Hyetograph values are also included for the short-duration storm ([Table 4.33: Short-Duration Storm Hyetograph Values for All Climate Regions](#)) and the regional storm for each of the four climate regions ([Table 4.34: Regional Storm Hyetograph Values for Climate Region 1: Cascade Mountains](#) through [Table 4.37: Regional Storm Hyetograph Values for Climate Region 4: Eastern Mountains](#)).

### 4.D.2 SCS Type IA Storm Hyetograph Values

**Table 4.31: SCS Type IA Storm Hyetograph Values**

Time (0.1 hours)	Incremental Rainfall	Cumulative Rainfall	Time (0.1 hours)	Incremental Rainfall	Cumulative Rainfall
0.0	0.000	0.000	12.1	0.004	0.668
0.1	0.002	0.002	12.2	0.003	0.671
0.2	0.002	0.004	12.3	0.004	0.675
0.3	0.002	0.006	12.4	0.004	0.679
0.4	0.002	0.008	12.5	0.004	0.683
0.5	0.002	0.010	12.6	0.004	0.687
0.6	0.002	0.012	12.7	0.003	0.690
0.7	0.002	0.014	12.8	0.004	0.694
0.8	0.002	0.016	12.9	0.003	0.697
0.9	0.002	0.018	13.0	0.004	0.701
1.0	0.002	0.020	13.1	0.004	0.705
1.1	0.003	0.023	13.2	0.003	0.708
1.2	0.003	0.026	13.3	0.004	0.712
1.3	0.003	0.029	13.4	0.004	0.716
1.4	0.003	0.032	13.5	0.003	0.719
1.5	0.003	0.035	13.6	0.003	0.722
1.6	0.003	0.038	13.7	0.004	0.726
1.7	0.003	0.041	13.8	0.003	0.729
1.8	0.003	0.044	13.9	0.004	0.733

**Table 4.31: SCS Type IA Storm Hyetograph Values (continued)**

Time (0.1 hours)	Incremental Rainfall	Cumulative Rainfall	Time (0.1 hours)	Incremental Rainfall	Cumulative Rainfall
1.9	0.003	0.047	14.0	0.003	0.736
2.0	0.003	0.050	14.1	0.003	0.739
2.1	0.003	0.053	14.2	0.004	0.743
2.2	0.003	0.056	14.3	0.003	0.746
2.3	0.004	0.060	14.4	0.003	0.749
2.4	0.003	0.063	14.5	0.004	0.753
2.5	0.003	0.066	14.6	0.003	0.756
2.6	0.003	0.069	14.7	0.003	0.759
2.7	0.003	0.072	14.8	0.004	0.763
2.8	0.004	0.076	14.9	0.003	0.766
2.9	0.003	0.079	15.0	0.003	0.769
3.0	0.003	0.082	15.1	0.003	0.772
3.1	0.003	0.085	15.2	0.004	0.776
3.2	0.003	0.088	15.3	0.003	0.779
3.3	0.003	0.091	15.4	0.003	0.782
3.4	0.004	0.095	15.5	0.003	0.785
3.5	0.003	0.098	15.6	0.003	0.788
3.6	0.003	0.101	15.7	0.004	0.792
3.7	0.004	0.105	15.8	0.003	0.795
3.8	0.004	0.109	15.9	0.003	0.798
3.9	0.003	0.112	16.0	0.003	0.801
4.0	0.004	0.116	16.1	0.003	0.804
4.1	0.004	0.120	16.2	0.003	0.807
4.2	0.003	0.123	16.3	0.003	0.810
4.3	0.004	0.127	16.4	0.003	0.813
4.4	0.004	0.131	16.5	0.003	0.816
4.5	0.004	0.135	16.6	0.003	0.819
4.6	0.004	0.139	16.7	0.003	0.822
4.7	0.004	0.143	16.8	0.003	0.825

**Table 4.31: SCS Type IA Storm Hyetograph Values (continued)**

Time (0.1 hours)	Incremental Rainfall	Cumulative Rainfall	Time (0.1 hours)	Incremental Rainfall	Cumulative Rainfall
4.8	0.004	0.147	16.9	0.003	0.828
4.9	0.005	0.152	17.0	0.003	0.831
5.0	0.004	0.156	17.1	0.003	0.834
5.1	0.005	0.161	17.2	0.003	0.837
5.2	0.004	0.165	17.3	0.003	0.840
5.3	0.005	0.170	17.4	0.003	0.843
5.4	0.005	0.175	17.5	0.003	0.846
5.5	0.005	0.180	16.7	0.003	0.822
5.6	0.005	0.185	17.7	0.002	0.851
5.7	0.005	0.190	17.8	0.003	0.854
5.8	0.005	0.195	17.9	0.003	0.857
5.9	0.005	0.200	18.0	0.003	0.860
6.0	0.006	0.206	18.1	0.003	0.863
6.1	0.006	0.212	18.2	0.002	0.865
6.2	0.006	0.218	18.3	0.003	0.868
6.3	0.006	0.224	18.4	0.003	0.871
6.4	0.007	0.231	18.5	0.003	0.874
6.5	0.006	0.237	18.6	0.002	0.876
6.6	0.006	0.243	18.7	0.003	0.879
6.7	0.006	0.249	18.8	0.003	0.882
6.8	0.006	0.255	18.9	0.002	0.884
6.9	0.006	0.261	19.0	0.003	0.887
7.0	0.007	0.268	19.1	0.003	0.890
7.1	0.007	0.275	19.2	0.002	0.892
7.2	0.008	0.283	19.3	0.003	0.895
7.3	0.008	0.291	19.4	0.002	0.897
7.4	0.009	0.300	19.5	0.003	0.900
7.5	0.010	0.310	19.6	0.003	0.903
7.6	0.021	0.331	19.7	0.002	0.905

**Table 4.31: SCS Type IA Storm Hyetograph Values (continued)**

Time (0.1 hours)	Incremental Rainfall	Cumulative Rainfall	Time (0.1 hours)	Incremental Rainfall	Cumulative Rainfall
7.7	0.024	0.355	19.8	0.003	0.908
7.8	0.024	0.379	19.9	0.002	0.910
7.9	0.024	0.403	20.0	0.003	0.913
8.0	0.022	0.425	20.1	0.002	0.915
8.1	0.014	0.439	20.2	0.003	0.918
8.2	0.013	0.452	20.3	0.002	0.920
8.3	0.010	0.462	20.4	0.002	0.922
8.4	0.010	0.472	20.5	0.003	0.925
8.5	0.008	0.480	20.6	0.002	0.927
8.6	0.009	0.489	20.7	0.003	0.930
8.7	0.009	0.498	20.8	0.002	0.932
8.8	0.007	0.505	20.9	0.002	0.934
8.9	0.008	0.513	21.0	0.003	0.937
9.0	0.007	0.520	21.1	0.002	0.939
9.1	0.007	0.527	21.2	0.002	0.941
9.2	0.006	0.533	21.3	0.003	0.944
9.3	0.006	0.539	21.4	0.002	0.946
9.4	0.006	0.545	21.5	0.002	0.948
9.5	0.005	0.550	21.6	0.003	0.951
9.6	0.006	0.556	21.7	0.002	0.953
9.7	0.005	0.561	21.8	0.002	0.955
9.8	0.006	0.567	21.9	0.002	0.957
9.9	0.005	0.572	22.0	0.002	0.959
10.0	0.005	0.577	22.1	0.003	0.962
10.1	0.005	0.582	22.2	0.002	0.964
10.2	0.005	0.587	22.3	0.002	0.966
10.3	0.005	0.592	22.4	0.002	0.968
10.4	0.004	0.596	22.5	0.002	0.970
10.5	0.005	0.601	22.6	0.002	0.972

**Table 4.31: SCS Type IA Storm Hyetograph Values (continued)**

Time (0.1 hours)	Incremental Rainfall	Cumulative Rainfall	Time (0.1 hours)	Incremental Rainfall	Cumulative Rainfall
10.6	0.005	0.606	22.7	0.002	0.974
10.7	0.004	0.610	22.8	0.002	0.976
10.8	0.005	0.615	22.9	0.002	0.978
10.9	0.005	0.620	23.0	0.002	0.980
11.0	0.004	0.624	23.1	0.002	0.982
11.1	0.004	0.628	23.2	0.002	0.984
11.2	0.005	0.633	23.3	0.002	0.986
11.3	0.004	0.637	23.4	0.002	0.988
11.4	0.004	0.641	23.5	0.002	0.990
11.5	0.004	0.645	23.6	0.002	0.992
11.6	0.004	0.649	23.7	0.002	0.994
11.7	0.004	0.653	23.8	0.002	0.996
11.8	0.004	0.657	23.9	0.002	0.998
11.9	0.003	0.660	24.0	0.002	1.000
12.0	0.004	0.664			

#### 4.D.3 SCS Type II Storm Hyetograph Values

**Table 4.32: SCS Type II Storm Hyetograph Values**

Time (0.1 hours)	Incremental Rainfall	Cumulative Rainfall	Time (0.1 hours)	Incremental Rainfall	Cumulative Rainfall
0.0	0.000	0.000	12.1	0.019	0.682
0.1	0.001	0.001	12.2	0.017	0.699
0.2	0.001	0.002	12.3	0.014	0.713
0.3	0.001	0.003	12.4	0.012	0.725
0.4	0.001	0.004	12.5	0.010	0.735
0.5	0.001	0.005	12.6	0.008	0.743
0.6	0.001	0.006	12.7	0.008	0.751
0.7	0.001	0.007	12.8	0.008	0.759
0.8	0.001	0.008	12.9	0.007	0.766

**Table 4.32: SCS Type II Storm Hyetograph Values (continued)**

Time (0.1 hours)	Incremental Rainfall	Cumulative Rainfall	Time (0.1 hours)	Incremental Rainfall	Cumulative Rainfall
0.9	0.001	0.009	13.0	0.006	0.772
1.0	0.002	0.011	13.1	0.006	0.778
1.1	0.001	0.012	13.2	0.006	0.784
1.2	0.001	0.013	13.3	0.005	0.789
1.3	0.001	0.014	13.4	0.005	0.794
1.4	0.001	0.015	13.5	0.005	0.799
1.5	0.001	0.016	13.6	0.005	0.804
1.6	0.001	0.017	13.7	0.004	0.808
1.7	0.001	0.018	13.8	0.004	0.812
1.8	0.002	0.020	13.9	0.004	0.816
1.9	0.001	0.021	14.0	0.004	0.820
2.0	0.001	0.022	14.1	0.004	0.824
2.1	0.001	0.023	14.2	0.003	0.827
2.2	0.001	0.024	14.3	0.004	0.831
2.3	0.002	0.026	14.4	0.003	0.834
2.4	0.001	0.027	14.5	0.004	0.838
2.5	0.001	0.028	14.6	0.003	0.841
2.6	0.001	0.029	14.7	0.003	0.844
2.7	0.002	0.031	14.8	0.003	0.847
2.8	0.001	0.032	14.9	0.003	0.850
2.9	0.001	0.033	15.0	0.004	0.854
3.0	0.002	0.035	15.1	0.002	0.856
3.1	0.001	0.036	15.2	0.003	0.859
3.2	0.001	0.037	15.3	0.003	0.862
3.3	0.001	0.038	15.4	0.003	0.865
3.4	0.002	0.040	15.5	0.003	0.868
3.5	0.001	0.041	15.6	0.002	0.870
3.6	0.001	0.042	15.7	0.003	0.873
3.7	0.002	0.044	15.8	0.002	0.875

**Table 4.32: SCS Type II Storm Hyetograph Values (continued)**

Time (0.1 hours)	Incremental Rainfall	Cumulative Rainfall	Time (0.1 hours)	Incremental Rainfall	Cumulative Rainfall
3.8	0.001	0.045	15.9	0.003	0.878
3.9	0.002	0.047	16.0	0.002	0.880
4.0	0.001	0.048	16.1	0.002	0.882
4.1	0.001	0.049	16.2	0.003	0.885
4.2	0.002	0.051	16.3	0.002	0.887
4.3	0.001	0.052	16.4	0.002	0.889
4.4	0.002	0.054	16.5	0.002	0.891
4.5	0.001	0.055	16.6	0.002	0.893
4.6	0.002	0.057	16.7	0.002	0.895
4.7	0.001	0.058	16.8	0.003	0.898
4.8	0.002	0.060	16.9	0.002	0.900
4.9	0.001	0.061	17.0	0.002	0.902
5.0	0.002	0.063	17.1	0.002	0.904
5.1	0.002	0.065	17.2	0.002	0.906
5.2	0.001	0.066	17.3	0.002	0.908
5.3	0.002	0.068	17.4	0.002	0.910
5.4	0.002	0.070	17.5	0.002	0.912
5.5	0.001	0.071	17.6	0.002	0.914
5.6	0.002	0.073	17.7	0.001	0.915
5.7	0.002	0.075	17.8	0.002	0.917
5.8	0.001	0.076	17.9	0.002	0.919
5.9	0.002	0.078	18.0	0.002	0.921
6.0	0.002	0.080	18.1	0.002	0.923
6.1	0.002	0.082	18.2	0.002	0.925
6.2	0.002	0.084	18.3	0.001	0.926
6.3	0.001	0.085	18.4	0.002	0.928
6.4	0.002	0.087	18.5	0.002	0.930
6.5	0.002	0.089	18.6	0.001	0.931
6.6	0.002	0.091	18.7	0.002	0.933

**Table 4.32: SCS Type II Storm Hyetograph Values (continued)**

Time (0.1 hours)	Incremental Rainfall	Cumulative Rainfall	Time (0.1 hours)	Incremental Rainfall	Cumulative Rainfall
6.7	0.002	0.093	18.8	0.002	0.935
6.8	0.002	0.095	18.9	0.001	0.936
6.9	0.002	0.097	19.0	0.002	0.938
7.0	0.002	0.099	19.1	0.001	0.939
7.1	0.002	0.101	19.2	0.002	0.941
7.2	0.002	0.103	19.3	0.001	0.942
7.3	0.002	0.105	19.4	0.002	0.944
7.4	0.002	0.107	19.5	0.001	0.945
7.5	0.002	0.109	19.6	0.002	0.947
7.6	0.002	0.111	19.7	0.001	0.948
7.7	0.002	0.113	19.8	0.001	0.949
7.8	0.003	0.116	19.9	0.002	0.951
7.9	0.002	0.118	20.0	0.001	0.952
8.0	0.002	0.120	20.1	0.001	0.953
8.1	0.002	0.122	20.2	0.002	0.955
8.2	0.003	0.125	20.3	0.001	0.956
8.3	0.002	0.127	20.4	0.001	0.957
8.4	0.003	0.130	20.5	0.001	0.958
8.5	0.002	0.132	20.6	0.002	0.960
8.6	0.003	0.135	20.7	0.001	0.961
8.7	0.003	0.138	20.8	0.001	0.962
8.8	0.003	0.141	20.9	0.002	0.964
8.9	0.003	0.144	21.0	0.001	0.965
9.0	0.003	0.147	21.1	0.001	0.966
9.1	0.003	0.150	21.2	0.001	0.967
9.2	0.003	0.153	21.3	0.001	0.968
9.3	0.004	0.157	21.4	0.002	0.970
9.4	0.003	0.160	21.5	0.001	0.971
9.5	0.003	0.163	21.6	0.001	0.972



**Table 4.32: SCS Type II Storm Hyetograph Values (continued)**

Time (0.1 hours)	Incremental Rainfall	Cumulative Rainfall	Time (0.1 hours)	Incremental Rainfall	Cumulative Rainfall
9.6	0.003	0.166	21.7	0.001	0.973
9.7	0.004	0.170	21.8	0.002	0.975
9.8	0.003	0.173	21.9	0.001	0.976
9.9	0.004	0.177	22.0	0.001	0.977
10.0	0.004	0.181	22.1	0.001	0.978
10.1	0.004	0.185	22.2	0.001	0.979
10.2	0.004	0.189	22.3	0.002	0.981
10.3	0.005	0.194	22.4	0.001	0.982
10.4	0.005	0.199	22.5	0.001	0.983
10.5	0.005	0.204	22.6	0.001	0.984
10.6	0.005	0.209	22.7	0.001	0.985
10.7	0.006	0.215	22.8	0.001	0.986
10.8	0.006	0.221	22.9	0.002	0.988
10.9	0.007	0.228	23.0	0.001	0.989
11.0	0.007	0.235	23.1	0.001	0.990
11.1	0.008	0.243	23.2	0.001	0.991
11.2	0.008	0.251	23.3	0.001	0.992
11.3	0.010	0.261	23.4	0.001	0.993
11.4	0.010	0.271	23.5	0.001	0.994
11.5	0.012	0.283	23.6	0.002	0.996
11.6	0.024	0.307	23.7	0.001	0.997
11.7	0.047	0.354	23.8	0.001	0.998
11.8	0.077	0.431	23.9	0.001	0.999
11.9	0.137	0.568	24.0	0.001	1.000
12.0	0.095	0.663			

**4.D.4 Short-Duration Storm Hyetograph Values for All Climate Regions**

Use the 2-hour precipitation value times 1.06 to determine the 3-hour total precipitation amount.

**Table 4.33: Short-Duration Storm Hyetograph Values for All Climate Regions**

Time (mins)	Time (hrs)	Incremental Rainfall	Cumulative Rainfall	Time (mins)	Time (hrs)	Incremental Rainfall	Cumulative Rainfall
0	0	0.0000	0.0000	95	1.58	0.0085	0.9133
5	0.08	0.0047	0.0047	100	1.67	0.0075	0.9208
10	0.17	0.0047	0.0094	105	1.75	0.0057	0.9265
15	0.25	0.0057	0.0151	110	1.83	0.0057	0.9322
20	0.33	0.0104	0.0255	115	1.92	0.0057	0.9379
25	0.42	0.0123	0.0378	120	2.00	0.0057	0.9436
30	0.50	0.0236	0.0614	125	2.08	0.0047	0.9483
35	0.58	0.0292	0.0906	130	2.17	0.0047	0.9530
40	0.67	0.0528	0.1434	135	2.25	0.0047	0.9577
45	0.75	0.0736	0.2170	140	2.33	0.0047	0.9624
50	0.83	0.1736	0.3906	145	2.42	0.0047	0.9671
55	0.92	0.2377	0.6283	150	2.50	0.0047	0.9718
60	1.00	0.1255	0.7538	155	2.58	0.0047	0.9765
65	1.08	0.0604	0.8142	160	2.67	0.0047	0.9812
70	1.17	0.0406	0.8548	165	2.75	0.0047	0.9859
75	1.25	0.0151	0.8699	170	2.83	0.0047	0.9906
80	1.33	0.0132	0.8831	175	2.92	0.0047	0.9953
85	1.42	0.0113	0.8944	180	3.00	0.0047	1.0000
90	1.50	0.0104	0.9048				

#### 4.D.5 Climate Region 1: Cascade Mountains

Use the 24-hour precipitation value times 1.16 to determine the long-duration storm total precipitation amount.

**Table 4.34: Regional Storm Hyetograph Values for Climate Region 1:  
Cascade Mountains**

Time (hours)	Incremental Rainfall	Cumulative Rainfall	Time (hours)	Incremental Rainfall	Cumulative Rainfall
0.0	0.0000	0.0000	18.5	0.0168	0.6402
0.5	0.0024	0.0024	19.0	0.0165	0.6566
1.0	0.0036	0.0060	19.5	0.0161	0.6728
1.5	0.0040	0.0101	20.0	0.0158	0.6886
2.0	0.0047	0.0148	20.5	0.0154	0.7040
2.5	0.0051	0.0199	21.0	0.0151	0.7191
3.0	0.0054	0.0253	21.5	0.0148	0.7339
3.5	0.0058	0.0311	22.0	0.0144	0.7483
4.0	0.0062	0.0374	22.5	0.0141	0.7623
4.5	0.0066	0.0439	23.0	0.0137	0.7761
5.0	0.0078	0.0517	23.5	0.0134	0.7894
5.5	0.0096	0.0614	24.0	0.0130	0.8025
6.0	0.0120	0.0733	24.5	0.0127	0.8151
6.5	0.0138	0.0871	25.0	0.0123	0.8275
7.0	0.0150	0.1022	25.5	0.0120	0.8395
7.5	0.0157	0.1179	26.0	0.0117	0.8512
8.0	0.0164	0.1343	26.5	0.0115	0.8627
8.5	0.0171	0.1513	27.0	0.0112	0.8739
9.0	0.0178	0.1691	27.5	0.0110	0.8849
9.5	0.0185	0.1876	28.0	0.0107	0.8956
10.0	0.0192	0.2067	28.5	0.0104	0.9060
10.5	0.0198	0.2266	29.0	0.0102	0.9162
11.0	0.0205	0.2471	29.5	0.0099	0.9261
11.5	0.0212	0.2683	30.0	0.0097	0.9358
12.0	0.0220	0.2904	30.5	0.0088	0.9446
12.5	0.0226	0.3130	31.0	0.0079	0.9525
13.0	0.0235	0.3364	31.5	0.0071	0.9596

**Table 4.34: Regional Storm Hyetograph Values for Climate Region 1: Cascade Mountains (continued)**

Time (hours)	Incremental Rainfall	Cumulative Rainfall	Time (hours)	Incremental Rainfall	Cumulative Rainfall
13.5	0.0243	0.3608	32.0	0.0063	0.9659
14.0	0.0297	0.3905	32.5	0.0058	0.9717
14.5	0.0338	0.4243	33.0	0.0054	0.9772
15.0	0.0507	0.4750	33.5	0.0050	0.9822
15.5	0.0315	0.5066	34.0	0.0047	0.9869
16.0	0.0283	0.5349	34.5	0.0043	0.9912
16.5	0.0257	0.5606	35.0	0.0039	0.9950
17.0	0.0231	0.5837	35.5	0.0030	0.9981
17.5	0.0214	0.6051	36.0	0.0019	1.0000
18.0	0.0183	0.6234			

#### 4.D.6 Climate Region 2: Central Basin

Use the 24-hour precipitation value (times 1.00) to determine the long-duration storm total precipitation amount.

**Table 4.35: Regional Storm Hyetograph Values for Climate Region 2: Central Basin**

Time (hours)	Incremental Rainfall	Cumulative Rainfall	Time (hours)	Incremental Rainfall	Cumulative Rainfall
0.0	0.0000	0.0000	12.5	0.0252	0.7374
0.5	0.0054	0.0054	13.0	0.0219	0.7593
1.0	0.0086	0.0140	13.5	0.0191	0.7783
1.5	0.0100	0.0240	14.0	0.0167	0.7950
2.0	0.0120	0.0360	14.5	0.0148	0.8098
2.5	0.0130	0.0490	15.0	0.0134	0.8232
3.0	0.0140	0.0630	15.5	0.0123	0.8355
3.5	0.0150	0.0780	16.0	0.0116	0.8471
4.0	0.0160	0.0940	16.5	0.0110	0.8581
4.5	0.0170	0.1110	17.0	0.0105	0.8686

**Table 4.35: Regional Storm Hyetograph Values for Climate Region 2: Central Basin (continued)**

Time (hours)	Incremental Rainfall	Cumulative Rainfall	Time (hours)	Incremental Rainfall	Cumulative Rainfall
5.0	0.0187	0.1297	17.5	0.0103	0.8789
5.5	0.0228	0.1525	18.0	0.0103	0.8892
6.0	0.0283	0.1808	18.5	0.0104	0.8996
6.5	0.0305	0.2113	19.0	0.0105	0.9100
7.0	0.0335	0.2448	19.5	0.0105	0.9205
7.5	0.0365	0.2813	20.0	0.0104	0.9309
8.0	0.0484	0.3297	20.5	0.0102	0.9412
8.5	0.0622	0.3919	21.0	0.0100	0.9512
9.0	0.0933	0.4852	21.5	0.0097	0.9609
9.5	0.0527	0.5380	22.0	0.0093	0.9702
10.0	0.0402	0.5782	22.5	0.0087	0.9789
10.5	0.0372	0.6154	23.0	0.0083	0.9872
11.0	0.0348	0.6502	23.5	0.0078	0.9950
11.5	0.0331	0.6833	24.0	0.0050	1.0000
12.0	0.0289	0.7122			

#### 4.D.7 Climate Region 3: Okanogan, Spokane, Palouse

Use the 24-hour precipitation value times 1.06 to determine the long-duration storm total precipitation amount.

**Table 4.36: Regional Storm Hyetograph Values for Climate Region 3: Okanogan, Spokane, Palouse**

Time (hours)	Incremental Rainfall	Cumulative Rainfall	Time (hours)	Incremental Rainfall	Cumulative Rainfall
0.0	0.0000	0.0000	15.5	0.0158	0.6759
0.5	0.0017	0.0017	16.0	0.0156	0.6915
1.0	0.0030	0.0047	16.5	0.0154	0.7069
1.5	0.0041	0.0088	17.0	0.0152	0.7221
2.0	0.0053	0.0141	17.5	0.0150	0.7372

**Table 4.36: Regional Storm Hyetograph Values for Climate Region 3: Okanogan, Spokane, Palouse (continued)**

Time (hours)	Incremental Rainfall	Cumulative Rainfall	Time (hours)	Incremental Rainfall	Cumulative Rainfall
2.5	0.0068	0.0209	18.0	0.0148	0.7519
3.0	0.0092	0.0301	18.5	0.0145	0.7664
3.5	0.0108	0.0409	19.0	0.0142	0.7806
4.0	0.0126	0.0535	19.5	0.0139	0.7945
4.5	0.0132	0.0667	20.0	0.0136	0.8081
5.0	0.0139	0.0806	20.5	0.0133	0.8215
5.5	0.0147	0.0952	21.0	0.0131	0.8346
6.0	0.0154	0.1106	21.5	0.0130	0.8475
6.5	0.0162	0.1268	22.0	0.0128	0.8603
7.0	0.0169	0.1437	22.5	0.0126	0.8729
7.5	0.0177	0.1614	23.0	0.0123	0.8852
8.0	0.0184	0.1798	23.5	0.0120	0.8972
8.5	0.0192	0.1990	24.0	0.0116	0.9088
9.0	0.0228	0.2219	24.5	0.0112	0.9200
9.5	0.0238	0.2457	25.0	0.0108	0.9308
10.0	0.0260	0.2717	25.5	0.0104	0.9412
10.5	0.0282	0.2999	26.0	0.0100	0.9512
11.0	0.0395	0.3394	26.5	0.0096	0.9607
11.5	0.0564	0.3958	27.0	0.0092	0.9699
12.0	0.0855	0.4813	27.5	0.0086	0.9785
12.5	0.0451	0.5265	28.0	0.0074	0.9859
13.0	0.0348	0.5612	28.5	0.0054	0.9913
13.5	0.0335	0.5948	29.0	0.0040	0.9953
14.0	0.0276	0.6223	29.5	0.0030	0.9983
14.5	0.0199	0.6422	30.0	0.0017	1.0000
15.0	0.0179	0.6601			

## 4.D.8 Climate Region 4: Eastern Mountains

Use the 24-hour precipitation value times 1.07 to determine the long-duration storm total precipitation amount.

**Table 4.37: Regional Storm Hyetograph Values for Climate Region 4: Eastern Mountains**

Time (hours)	Incremental Rainfall	Cumulative Rainfall	Time (hours)	Incremental Rainfall	Cumulative Rainfall
0.0	0.0000	0.0000	15.5	0.0155	0.6606
0.5	0.0015	0.0015	16.0	0.0153	0.6759
1.0	0.0031	0.0046	16.5	0.0151	0.6910
1.5	0.0047	0.0094	17.0	0.0149	0.7059
2.0	0.0064	0.0158	17.5	0.0148	0.7207
2.5	0.0082	0.0239	18.0	0.0146	0.7353
3.0	0.0104	0.0343	18.5	0.0144	0.7496
3.5	0.0115	0.0458	19.0	0.0142	0.7639
4.0	0.0123	0.0581	19.5	0.0140	0.7779
4.5	0.0130	0.0711	20.0	0.0137	0.7915
5.0	0.0137	0.0848	20.5	0.0134	0.8049
5.5	0.0145	0.0993	21.0	0.0132	0.8181
6.0	0.0152	0.1145	21.5	0.0131	0.8312
6.5	0.0160	0.1305	22.0	0.0129	0.8441
7.0	0.0167	0.1472	22.5	0.0129	0.8570
7.5	0.0174	0.1646	23.0	0.0128	0.8697
8.0	0.0182	0.1828	23.5	0.0127	0.8825
8.5	0.0190	0.2019	24.0	0.0127	0.8951
9.0	0.0207	0.2226	24.5	0.0126	0.9077
9.5	0.0232	0.2458	25.0	0.0124	0.9201
10.0	0.0260	0.2717	25.5	0.0121	0.9322
10.5	0.0278	0.2996	26.0	0.0116	0.9438
11.0	0.0399	0.3394	26.5	0.0109	0.9547
11.5	0.0531	0.3925	27.0	0.0101	0.9647

**Table 4.37: Regional Storm Hyetograph Values for Climate Region 4:  
Eastern Mountains (continued)**

Time (hours)	Incremental Rainfall	Cumulative Rainfall	Time (hours)	Incremental Rainfall	Cumulative Rainfall
12.0	0.0796	0.4722	27.5	0.0090	0.9738
12.5	0.0441	0.5162	28.0	0.0077	0.9814
13.0	0.0329	0.5492	28.5	0.0061	0.9875
13.5	0.0303	0.5795	29.0	0.0051	0.9926
14.0	0.0291	0.6086	29.5	0.0045	0.9971
14.5	0.0199	0.6284	30.0	0.0029	1.0000
15.0	0.0166	0.6451			



## Appendix 4-E: Example SBUH Runoff Hydrograph

### Existing Site Condition

#### CLIMATE REGION 2, 25-YEAR REGIONAL STORM

<u>Given</u>			
Area (acres) = <b>5.0</b>			
$w = \text{routing constant} = d_t / (2T_c + d_t) = \mathbf{0.2727}$			
$P_t$ (inches) = <b>1.6</b>			
$d_t$ (minutes) = <b>30</b>			
$T_c$ (minutes) = <b>40</b>			
Pervious Area (acres) = <b>5.0</b>	CN = 65	$S = (1000/CN) - 10 = 5.38$	$0.2S = 1.08$
Impervious Area (acres) = <b>0.0</b>	CN = 98	$S = (1000/CN) - 10 = 0.20$	$0.2S = 0.04$

- Column (1) = Time increment
- Column (2) = Time (minutes)
- Column (3) = Rainfall distribution (fraction)
- Column (4) = Incremental rainfall (inches) = Column (3) x  $P_t$
- Column (5) = Accumulated rainfall (inches) = P = Accumulated sum of Column (4)
- Column (6) = Accumulated runoff from the pervious area (inches) = (If  $P \leq 0.2S$ ) = 0; (If  $P > 0.2S$ ) =  $[(\text{Column (5)} - 0.2)^2 / (\text{Column (5)} + 0.8S)]$  where pervious area S value is used
- Column (7) = Incremental runoff from the pervious area (inches) = Column (6) of present step – Column (6) of previous step
- Column (8) = Accumulated runoff from the impervious area (inches) = (If  $P \leq 0.2S$ ) = 0; (If  $P > 0.2S$ ) =  $[(\text{Column (5)} - 0.2)^2 / (\text{Column (5)} + 0.8S)]$  where impervious area S value is used
- Column (9) = Incremental runoff from the impervious area (inches) = Column (8) of present step – Column (8) of previous step
- Column (10) = Total runoff (inches) =  $[(\text{Pervious Area} / \text{Total Area}) * \text{Column (7)}] + [(\text{Impervious Area} / \text{Total Area}) * \text{Column (9)}]$
- Column (11) = Instantaneous flow rate (cfs) =  $(60.5 * \text{Column (10)} * \text{TOTAL AREA}) / d_t$
- Column (12) = Design flow rate = Column (12) of previous time +  $w[(\text{Column (11) of previous time step} + \text{Column (11) of present time step}) - (2 * \text{Column (12) of previous time step})]$  where  $w = d_t / (2T_c + d_t)$

(1)	(2)	(3)	(4)	(5)	(6)	(7)	(8)	(9)	(10)	(11)	(12)
1	0	0.00000	0.000	0.000	0.000	0.000	0.000	0.000	0.000	0.0	0.00
2	30	0.00000	0.000	0.000	0.000	0.000	0.000	0.000	0.000	0.0	0.00
3	60	0.00000	0.000	0.000	0.000	0.000	0.000	0.000	0.000	0.0	0.00
...											
90	2670	0.06220	0.100	0.934	0.000	0.000	0.495	0.089	0.000	0.0	0.00
91	2700	0.09330	0.149	1.083	0.000	0.000	0.632	0.137	0.000	0.0	0.00
92	2730	0.05275	0.084	1.167	0.001	0.001	0.711	0.079	0.001	0.0	0.00
93	2760	0.04025	0.064	1.232	0.004	0.003	0.772	0.061	0.003	0.0	0.01
94	2790	0.03717	0.059	1.291	0.008	0.004	0.828	0.056	0.004	0.0	0.02
95	2820	0.03483	0.056	1.347	0.013	0.005	0.881	0.053	0.005	0.0	0.03
96	2850	0.03307	0.053	1.400	0.018	0.005	0.931	0.051	0.005	0.1	0.04
97	2880	0.02893	0.046	1.446	0.024	0.005	0.976	0.044	0.005	0.1	0.05
98	2910	0.02519	0.040	1.486	0.029	0.005	1.015	0.039	0.005	0.1	0.05
99	2940	0.02189	0.035	1.521	0.034	0.005	1.048	0.034	0.005	0.0	0.05
100	2970	0.01906	0.030	1.552	0.039	0.005	1.078	0.029	0.005	0.0	0.05
101	3000	0.01670	0.027	1.579	0.043	0.004	1.103	0.026	0.004	0.0	0.05
102	3030	0.01480	0.024	1.602	0.047	0.004	1.126	0.023	0.004	0.0	0.04
103	3060	0.01336	0.021	1.624	0.050	0.004	1.147	0.021	0.004	0.0	0.04
104	3090	0.01234	0.020	1.643	0.054	0.004	1.166	0.019	0.004	0.0	0.04
105	3120	0.01156	0.018	1.662	0.057	0.003	1.184	0.018	0.003	0.0	0.04
106	3150	0.01096	0.018	1.679	0.061	0.003	1.201	0.017	0.003	0.0	0.04
107	3180	0.01054	0.017	1.696	0.064	0.003	1.217	0.016	0.003	0.0	0.03
108	3210	0.01032	0.017	1.713	0.067	0.003	1.233	0.016	0.003	0.0	0.03
109	3240	0.01028	0.016	1.729	0.070	0.003	1.249	0.016	0.003	0.0	0.03
110	3270	0.01038	0.017	1.746	0.074	0.003	1.265	0.016	0.003	0.0	0.03
111	3300	0.01046	0.017	1.763	0.077	0.004	1.282	0.016	0.004	0.0	0.03
112	3330	0.01046	0.017	1.779	0.081	0.004	1.298	0.016	0.004	0.0	0.04
113	3360	0.01040	0.017	1.796	0.085	0.004	1.314	0.016	0.004	0.0	0.04
114	3390	0.01025	0.016	1.812	0.088	0.004	1.330	0.016	0.004	0.0	0.04
115	3420	0.01004	0.016	1.828	0.092	0.004	1.346	0.016	0.004	0.0	0.04
116	3450	0.00974	0.016	1.844	0.096	0.004	1.361	0.015	0.004	0.0	0.04
117	3480	0.00926	0.015	1.859	0.099	0.003	1.375	0.014	0.003	0.0	0.04

(1)	(2)	(3)	(4)	(5)	(6)	(7)	(8)	(9)	(10)	(11)	(12)
118	3510	0.00868	0.014	1.873	0.102	0.003	1.389	0.014	0.003	0.0	0.04
119	3540	0.00832	0.013	1.886	0.106	0.003	1.402	0.013	0.003	0.0	0.03
120	3570	0.00781	0.012	1.899	0.109	0.003	1.414	0.012	0.003	0.0	0.03
121	3600	0.00500	0.008	1.907	0.111	0.002	1.422	0.008	0.002	0.0	0.03
122	3630	0.00000	0.000	1.907	0.111	0.000	1.422	0.000	0.000	0.0	0.02
123	3660	0.00000	0.000	1.907	0.111	0.000	1.422	0.000	0.000	0.0	0.01
124	3690	0.00000	0.000	1.907	0.111	0.000	1.422	0.000	0.000	0.0	0.00
125	3720	0.00000	0.000	1.907	0.111	0.000	1.422	0.000	0.000	0.0	0.00
...											
145	4320	0.00000	0.000	1.907	0.111	0.000	1.422	0.000	0.000	0.0	0.00

### ***Proposed Development Site Condition***

#### **CLIMATE REGION 2, 25-YEAR REGIONAL STORM**

<b><u>Given</u></b>			
Area (acres) = <b>5.0</b>			
$w = \text{routing constant} = d_t / (2T_c + d_t) = \mathbf{0.750}$			
$P_t$ (inches) = <b>1.6</b>			
$d_t$ (minutes) = <b>30</b>			
$T_c$ (minutes) = <b>5</b>			
Pervious Area (acres) = 0.5	CN = 65	$S = (1000/CN) - 10 = 5.38$	$0.2S = 1.08$
Impervious Area (acres) = 4.5	CN = 98	$S = (1000/CN) - 10 = 0.20$	$0.2S = 0.04$

- Column (1) = Time increment
- Column (2) = Time (minutes)
- Column (3) = Rainfall distribution (fraction)
- Column (4) = Incremental rainfall (inches) = Column (3) x  $P_t$
- Column (5) = Accumulated rainfall (inches) = P = Accumulated sum of Column (4)
- Column (6) = Accumulated runoff from the pervious area (inches) = (If  $P \leq 0.2S$ ) = 0; (If  $P > 0.2S$ ) =  $[(\text{Column (5)} - 0.2)^2 / (\text{Column (5)} + 0.8S)]$  where pervious area S value is used
- Column (7) = Incremental runoff from the pervious area (inches) = Column (6) of present step – Column (6) of previous step
- Column (8) = Accumulated runoff from the impervious area (inches) = (If  $P \leq 0.2S$ ) = 0; (If  $P >$

$0.2S) = [(Column (5) - 0.2)^2 / (Column (5) + 0.8S)]$  where impervious area S value is used

- Column (9) = Incremental runoff from the impervious area (inches) = Column (8) of present step – Column (8) of previous step
- Column (10) = Total runoff (inches) = [(PERVIOUS AREA/TOTAL AREA) \* Column (7)] + [(IMPERVIOUS AREA/TOTAL AREA) x Column (9)]
- Column (11) = Instantaneous flow rate (cfs) = (60.5 x Column (10) x TOTAL AREA)/d<sub>t</sub>
- Column (12) = Design flow rate = Column (12) of previous time + w[(Column (11) of previous time step + Column (11) of present time step) – (2 x Column (12) of previous time step)] where  $w = d_t / (2T_c + d_t)$

(1)	(2)	(3)	(4)	(5)	(6)	(7)	(8)	(9)	(10)	(11)	(12)
1	0	0.00000	0.000	0.000	0.000	0.000	0.000	0.000	0.000	0.0	0.00
2	30	0.00000	0.000	0.000	0.000	0.000	0.000	0.000	0.000	0.0	0.00
3	60	0.00000	0.000	0.000	0.000	0.000	0.000	0.000	0.000	0.0	0.00
...											
22	630	0.01669	0.027	0.046	0.000	0.000	0.000	0.000	0.000	0.0	0.00
23	660	0.02831	0.045	0.092	0.000	0.000	0.010	0.010	0.009	0.1	0.07
24	690	0.04680	0.075	0.167	0.000	0.000	0.048	0.038	0.034	0.3	0.29
25	720	0.03120	0.050	0.217	0.000	0.000	0.081	0.033	0.030	0.3	0.34
26	750	0.02549	0.041	0.257	0.000	0.000	0.111	0.030	0.027	0.3	0.26
27	780	0.01451	0.023	0.281	0.000	0.000	0.129	0.018	0.016	0.2	0.20
28	810	0.00445	0.007	0.288	0.000	0.000	0.135	0.006	0.005	0.1	0.06
29	840	0.00202	0.003	0.291	0.000	0.000	0.138	0.003	0.002	0.0	0.02
30	870	0.00192	0.003	0.294	0.000	0.000	0.140	0.002	0.002	0.0	0.02
31	900	0.00172	0.003	0.297	0.000	0.000	0.142	0.002	0.002	0.0	0.02
32	930	0.00152	0.002	0.299	0.000	0.000	0.144	0.002	0.002	0.0	0.02
33	960	0.00132	0.002	0.301	0.000	0.000	0.146	0.002	0.002	0.0	0.02
34	990	0.00112	0.002	0.303	0.000	0.000	0.147	0.001	0.001	0.0	0.01
35	1020	0.00092	0.001	0.305	0.000	0.000	0.149	0.001	0.001	0.0	0.01
36	1050	0.00072	0.001	0.306	0.000	0.000	0.150	0.001	0.001	0.0	0.01
37	1080	0.00052	0.001	0.307	0.000	0.000	0.150	0.001	0.001	0.0	0.01
38	1110	0.00000	0.000	0.307	0.000	0.000	0.150	0.000	0.000	0.0	0.00
39	1140	0.00000	0.000	0.307	0.000	0.000	0.150	0.000	0.000	0.0	0.00
...											

(1)	(2)	(3)	(4)	(5)	(6)	(7)	(8)	(9)	(10)	(11)	(12)
72	2130	0.00000	0.000	0.307	0.000	0.000	0.150	0.000	0.000	0.0	0.00
73	2160	0.00000	0.000	0.307	0.000	0.000	0.150	0.000	0.000	0.0	0.00
74	2190	0.00544	0.009	0.315	0.000	0.000	0.157	0.007	0.006	0.1	0.05
75	2220	0.00856	0.014	0.329	0.000	0.000	0.169	0.011	0.010	0.1	0.10
76	2250	0.01000	0.016	0.345	0.000	0.000	0.182	0.013	0.012	0.1	0.12
77	2280	0.01200	0.019	0.364	0.000	0.000	0.198	0.016	0.015	0.1	0.14
78	2310	0.01300	0.021	0.385	0.000	0.000	0.216	0.018	0.016	0.2	0.16
79	2340	0.01400	0.022	0.407	0.000	0.000	0.235	0.019	0.017	0.2	0.17
80	2370	0.01500	0.024	0.431	0.000	0.000	0.256	0.021	0.019	0.2	0.19
81	2400	0.01600	0.026	0.457	0.000	0.000	0.279	0.023	0.020	0.2	0.20
82	2430	0.01700	0.027	0.484	0.000	0.000	0.304	0.024	0.022	0.2	0.22
83	2460	0.01869	0.030	0.514	0.000	0.000	0.331	0.027	0.024	0.2	0.24
84	2490	0.02281	0.036	0.551	0.000	0.000	0.364	0.033	0.030	0.3	0.29
85	2520	0.02832	0.045	0.596	0.000	0.000	0.406	0.042	0.038	0.4	0.37
86	2550	0.03050	0.049	0.645	0.000	0.000	0.451	0.045	0.041	0.4	0.41
87	2580	0.03350	0.054	0.698	0.000	0.000	0.502	0.050	0.045	0.5	0.45
88	2610	0.03650	0.058	0.757	0.000	0.000	0.557	0.055	0.050	0.5	0.50
89	2640	0.04842	0.077	0.834	0.000	0.000	0.631	0.074	0.067	0.7	0.63
90	2670	0.06220	0.100	0.934	0.000	0.000	0.727	0.096	0.086	0.9	0.84
91	2700	0.09330	0.149	1.083	0.000	0.000	0.871	0.145	0.130	1.3	1.22
92	2730	0.05275	0.084	1.167	0.001	0.001	0.954	0.082	0.074	0.7	0.94
93	2760	0.04025	0.064	1.232	0.004	0.003	1.017	0.063	0.057	0.6	0.52
94	2790	0.03717	0.059	1.291	0.008	0.004	1.075	0.058	0.053	0.5	0.57
95	2820	0.03483	0.056	1.347	0.013	0.005	1.130	0.055	0.050	0.5	0.49
96	2850	0.03307	0.053	1.400	0.018	0.005	1.182	0.052	0.047	0.5	0.49
97	2880	0.02893	0.046	1.446	0.024	0.005	1.227	0.046	0.042	0.4	0.43
98	2910	0.02519	0.040	1.486	0.029	0.005	1.267	0.040	0.036	0.4	0.37
99	2940	0.02189	0.035	1.521	0.034	0.005	1.301	0.034	0.032	0.3	0.33
100	2970	0.01906	0.030	1.552	0.039	0.005	1.331	0.030	0.028	0.3	0.28
101	3000	0.01670	0.027	1.579	0.043	0.004	1.358	0.026	0.024	0.2	0.25
102	3030	0.01480	0.024	1.602	0.047	0.004	1.381	0.023	0.021	0.2	0.22
103	3060	0.01336	0.021	1.624	0.050	0.004	1.402	0.021	0.019	0.2	0.20

(1)	(2)	(3)	(4)	(5)	(6)	(7)	(8)	(9)	(10)	(11)	(12)
104	3090	0.01234	0.020	1.643	0.054	0.004	1.422	0.019	0.018	0.2	0.18
105	3120	0.01156	0.018	1.662	0.057	0.003	1.440	0.018	0.017	0.2	0.17
106	3150	0.01096	0.018	1.679	0.061	0.003	1.457	0.017	0.016	0.2	0.16
107	3180	0.01054	0.017	1.696	0.064	0.003	1.474	0.017	0.015	0.2	0.16
108	3210	0.01032	0.017	1.713	0.067	0.003	1.490	0.016	0.015	0.2	0.15
109	3240	0.01028	0.016	1.729	0.070	0.003	1.506	0.016	0.015	0.2	0.15
110	3270	0.01038	0.017	1.746	0.074	0.003	1.523	0.016	0.015	0.2	0.15
111	3300	0.01046	0.017	1.763	0.077	0.004	1.539	0.017	0.015	0.2	0.15
112	3330	0.01046	0.017	1.779	0.081	0.004	1.556	0.017	0.015	0.2	0.15
113	3360	0.01040	0.017	1.796	0.085	0.004	1.572	0.016	0.015	0.2	0.15
114	3390	0.01025	0.016	1.812	0.088	0.004	1.589	0.016	0.015	0.2	0.15
115	3420	0.01004	0.016	1.828	0.092	0.004	1.604	0.016	0.015	0.1	0.15
116	3450	0.00974	0.016	1.844	0.096	0.004	1.620	0.015	0.014	0.1	0.14
117	3480	0.00926	0.015	1.859	0.099	0.003	1.635	0.015	0.014	0.1	0.14
118	3510	0.00868	0.014	1.873	0.102	0.003	1.648	0.014	0.013	0.1	0.13
119	3540	0.00832	0.013	1.886	0.106	0.003	1.662	0.013	0.012	0.1	0.12
120	3570	0.00781	0.012	1.899	0.109	0.003	1.674	0.012	0.011	0.1	0.12
121	3600	0.00500	0.008	1.907	0.111	0.002	1.682	0.008	0.007	0.1	0.08
122	3630	0.00000	0.000	1.907	0.111	0.000	1.682	0.000	0.000	0.0	0.01
123	3660	0.00000	0.000	1.907	0.111	0.000	1.682	0.000	0.000	0.0	0.00
124	3690	0.00000	0.000	1.907	0.111	0.000	1.682	0.000	0.000	0.0	0.00
...											
144	4290	0.00000	0.000	1.907	0.111	0.000	1.682	0.000	0.000	0.0	0.00
145	4320	0.00000	0.000	1.907	0.111	0.000	1.682	0.000	0.000	0.0	0.00

# Chapter 5 - Runoff Treatment BMP Design

## 5.1 Introduction to Runoff Treatment BMP Design

### 5.1.1 Introduction

Best Management Practices (BMPs) are schedules of activities, prohibitions of practices, maintenance procedures, managerial practices, or structural features that prevent or reduce adverse impacts on waters of Washington State. BMPs for long-term management of stormwater at developed sites can be divided into three main categories:

- BMPs addressing the volume and timing of stormwater flows
- BMPs addressing prevention of pollution from potential sources
- BMPs addressing treatment of runoff to remove sediment and other pollutants

This section of the *Stormwater Management Manual for Eastern Washington* (manual) focuses on the third category, treatment of runoff to remove sediment and other pollutants at developed sites. The purpose of this section is to provide guidance for selection, design, and maintenance of permanent runoff treatment BMPs.

Runoff treatment BMPs are designed to remove pollutants contained in stormwater runoff. The pollutants of concern include sand, silt, and other suspended solids; metals such as copper, lead, and zinc; nutrients (e.g., nitrogen and phosphorus); certain bacteria and viruses; and organics such as petroleum hydrocarbons and pesticides. Methods of pollutant removal include sedimentation/settling, filtration, plant uptake, ion exchange, adsorption, and bacterial decomposition. Floatable pollutants such as oil, debris, and scum can be removed with separator structures.

### 5.1.2 How to Use This Chapter

This chapter should be consulted to select specific runoff treatment BMPs for inclusion in Stormwater Site Plans to meet [2.7.6 Core Element #5: Runoff Treatment](#) requirements. See the exemptions and requirements in [2.7.6 Core Element #5: Runoff Treatment](#) to determine whether [2.7.6 Core Element #5: Runoff Treatment](#) applies and, if it does, the type or types of runoff treatment BMPs required for the project. This chapter can then be used to select specific BMPs for permanent use at developed sites and as an aid in designing and constructing those BMPs.

### 5.1.3 Runoff Treatment Methods and BMPs

Runoff treatment methods and BMPs described in this chapter include the following:

- Surface infiltration and bioinfiltration
- Biofiltration
- Subsurface infiltration (Underground Injection Control wells)
- Wetpool (wetpond, wetvault) and dry pond

- Filtration (sand filter, media filter drain)
- Evaporation pond
- Oil and water separator
- Emerging technologies

### 5.1.4 Performance Goals and BMP Options

The water quality design storm volume and flow rates are intended to capture and effectively treat at least 90% of the annual runoff volume. BMPs that are designed, operated, and maintained according to the criteria set forth in this chapter should also capture and treat nearly all of the first flush events. Pollutant removal performance goals for each of the major categories of BMPs, including basic treatment, oil control, phosphorus treatment, and metals treatment, are provided below.

#### **Basic Treatment**

The basic treatment BMP choices shown in [Figure 5.1: Runoff Treatment BMP Selection Flow Chart](#) are intended to achieve 80% removal of total suspended solids (TSS) for influent concentrations that are > 100 milligrams per liter (mg/L), but < 200 mg/L. For influent concentrations > 200 mg/L, a higher treatment goal may be appropriate. For influent concentrations < 100 mg/L, the BMPs are intended to achieve an effluent goal of 20 mg/L TSS. The performance goal applies to the water quality design storm volume or flow rate, whichever is applicable. The goal also applies on an average annual basis to the entire annual discharge volume (treated plus bypassed).

#### **Oil Control**

The oil control BMP choices shown in [Figure 5.1: Runoff Treatment BMP Selection Flow Chart](#) are intended to achieve the goals of no ongoing or recurring visible sheen and to have a 24-hour average total petroleum hydrocarbon (TPH) concentration < 10 mg/L and a maximum of 15 mg/L for a discrete sample (grab sample).

#### **Phosphorus Treatment**

The phosphorus treatment BMP choices in [Figure 5.1: Runoff Treatment BMP Selection Flow Chart](#) are intended to achieve a goal of 50% total phosphorus removal for a range of influent concentrations of 0.1 to 0.5 mg/L total phosphorus. In addition, the choices are intended to achieve the basic treatment performance goal.

The performance goal applies to the water quality design storm volume or flow rate, whichever is applicable, on an annual average basis. The incremental portion of runoff in excess of the water quality design flow rate or volume can be routed around the BMP (off-line treatment BMPs), or can be passed through the BMP (online treatment BMPs) provided a net pollutant reduction is maintained. The Washington State Department of Ecology (Ecology) encourages the design and operation of treatment BMPs that engage a bypass at flow rates higher than the water quality design flow rate. However, this is only acceptable provided that the overall reduction in phosphorus loading (treated plus bypassed) is at least equal to that achieved with initiating bypass at the water quality design flow rate.

Any one of the following options may be chosen to satisfy the phosphorus treatment requirement:



- Infiltration With Appropriate Pretreatment – See [5.4 Surface Infiltration and Bioinfiltration BMPs](#).
- Infiltration Treatment – If infiltration is through soils meeting the minimum Site Suitability Criteria (SSC) for infiltration treatment (see [5.4.3 General Criteria for Infiltration and Bioinfiltration BMPs](#)), a presettling basin or a basic treatment BMP can serve for pretreatment.
- Infiltration Preceded by Basic Treatment – If infiltration is through soils that do not meet the SSC for infiltration treatment, treatment must be provided by a basic treatment BMP unless the soil and site fit the description in Infiltration preceded by phosphorus treatment.
- Infiltration Preceded by Phosphorus Treatment – Requirements to be determined by Total Maximum Daily Load (TMDL).
- Large Wetpond – See [5.7 Wetpool/Wetpond and Dry Pond BMPs](#).
- Emerging Stormwater Treatment Technologies Targeted for Phosphorus Removal – See [5.11 Emerging Technologies](#).
- Two-BMP Treatment Trains – See [Table 5.1: Treatment Trains for Phosphorus Removal](#).

**Note:** If a filter is preceded by a wetpond, a horizontal rock filter may reduce transfer of algae from the pond to the filter.

**Table 5.1: Treatment Trains for Phosphorus Removal**

First Basic Treatment BMP	Second Treatment BMP
<a href="#">BMP T5.40: Biofiltration Swale</a>	
or	
<a href="#">BMP T5.70: Basic Wetpond</a>	
or	<a href="#">BMP T5.80: Basic Sand Filter</a>
<a href="#">BMP T5.72: Wetvaults</a>	or
or	<a href="#">BMP T5.82: Sand Filter Vault</a>
<a href="#">BMP T5.73: Stormwater Treatment Wetland</a>	
or	
Basic Combined Detention and Wetpool	
<a href="#">BMP T5.50: Vegetated Filter Strip</a>	<a href="#">BMP T5.83: Linear Sand Filter</a>
	(no presettling needed)
<a href="#">BMP T5.83: Linear Sand Filter</a>	<a href="#">BMP T5.50: Vegetated Filter Strip</a>

**For more information:** See [5.2.4 Cold Weather Considerations](#) (or [Table 5.8: Summary of BMP Applicability in Cold Regions](#)) for cold weather considerations and [Table 5.6: Recommended Stormwater Treatment BMPs Based on Climate Type](#) for arid and semiarid climate considerations.

## Metals Treatment

The metals treatment BMP choices in [Figure 5.1: Runoff Treatment BMP Selection Flow Chart](#) are intended to provide a higher rate of removal of dissolved metals than basic treatment BMPs. Based on a review of dissolved metals removal of basic treatment options, a “higher rate of removal” is currently defined as > 30% dissolved copper removal, and > 60% dissolved zinc removal. In addition, the menu choices are intended to achieve the basic treatment performance goal. The performance goal assumes that the BMP is treating stormwater with dissolved copper typically ranging from 0.005 to 0.02 mg/L, and dissolved zinc ranging from 0.02 to 0.3 mg/L.

The performance goal applies to the water quality design storm volume or flow rate, whichever is applicable, and on an annual average basis. The incremental portion of runoff in excess of the water quality design flow rate or volume can be routed around the BMP (off-line treatment BMPs) or can be passed through the BMP (online treatment BMPs) provided a net pollutant reduction is maintained. Ecology encourages the design and operation of runoff treatment BMPs that engage a bypass at flow rates higher than the water quality design flow rate as long as the reduction in dissolved metals loading exceeds that achieved with initiating bypass at the water quality design flow rate.

Any one of the following options may be chosen to satisfy the metals treatment requirement:

- Infiltration With Appropriate Pretreatment – See [5.4 Surface Infiltration and Bioinfiltration BMPs](#).
- Infiltration Treatment – If infiltration is through soils meeting the minimum SSC for infiltration treatment (see [5.4 Surface Infiltration and Bioinfiltration BMPs](#)), a presettling basin or a basic treatment BMP can serve for pretreatment.
- Infiltration Preceded by Basic Treatment – If infiltration is through soils that do not meet the SSC for infiltration treatment, treatment must be provided by a basic treatment BMP unless the soil and site fit the description in the next option below.
- Infiltration Preceded by Metals Treatment – If the soils do not meet the SSC and the infiltration site is within 0.25 miles of a fish-bearing stream, a tributary to a fish-bearing stream, or a lake, treatment must be provided by one of the other treatment BMP options listed below.
- Large Sand Filter – See [5.8 Filtration BMPs](#).
- Amended Sand Filter – See [5.11 Emerging Technologies](#).

**For more information:** Processed steel fiber and crushed calcitic limestone are the only sand filter amendments for which Ecology has data that document increased dissolved metals removal. Though Ecology is interested in obtaining additional data on the effectiveness of these amendments, local jurisdictions may exercise their judgment on the extent to which to allow their use.

- Emerging Technologies Targeted for Dissolved Metals Removal – See [5.11 Emerging Technologies](#).
- Two-BMP Treatment Trains – See [Table 5.2: Treatment Trains for Dissolved Metals Removal](#).

**Table 5.2: Treatment Trains for Dissolved Metals Removal**

First Basic Treatment BMP	Second Treatment BMP
<p><a href="#">BMP T5.40: Biofiltration Swale</a></p> <p>or</p> <p><a href="#">BMP T5.70: Basic Wetpond</a></p> <p>or</p> <p><a href="#">BMP T5.72: Wetvaults</a></p> <p>or</p> <p>Basic Combined Detention/Wetpool</p>	<p><a href="#">BMP T5.80: Basic Sand Filter</a></p> <p>or</p> <p><a href="#">BMP T5.82: Sand Filter Vault</a></p> <p>or</p> <p>Emerging Technologies - See <a href="#">5.11 Emerging Technologies</a>. The Emerging Technology must be a type approved for basic or metals treatment use by Ecology.</p>
<p><a href="#">BMP T5.50: Vegetated Filter Strip</a></p>	<p><a href="#">BMP T5.83: Linear Sand Filter</a></p> <p>(no presettling needed)</p>
<p><a href="#">BMP T5.83: Linear Sand Filter</a></p>	<p><a href="#">BMP T5.50: Vegetated Filter Strip</a></p>

## 5.2 Runoff Treatment BMP Selection Process

### 5.2.1 Introduction to the Runoff Treatment BMP Selection Process

This section describes a process for selecting the type of runoff treatment Best Management Practices (BMPs) that will apply to individual projects.

### 5.2.2 Step-by-Step Selection Process for Runoff Treatment BMPs

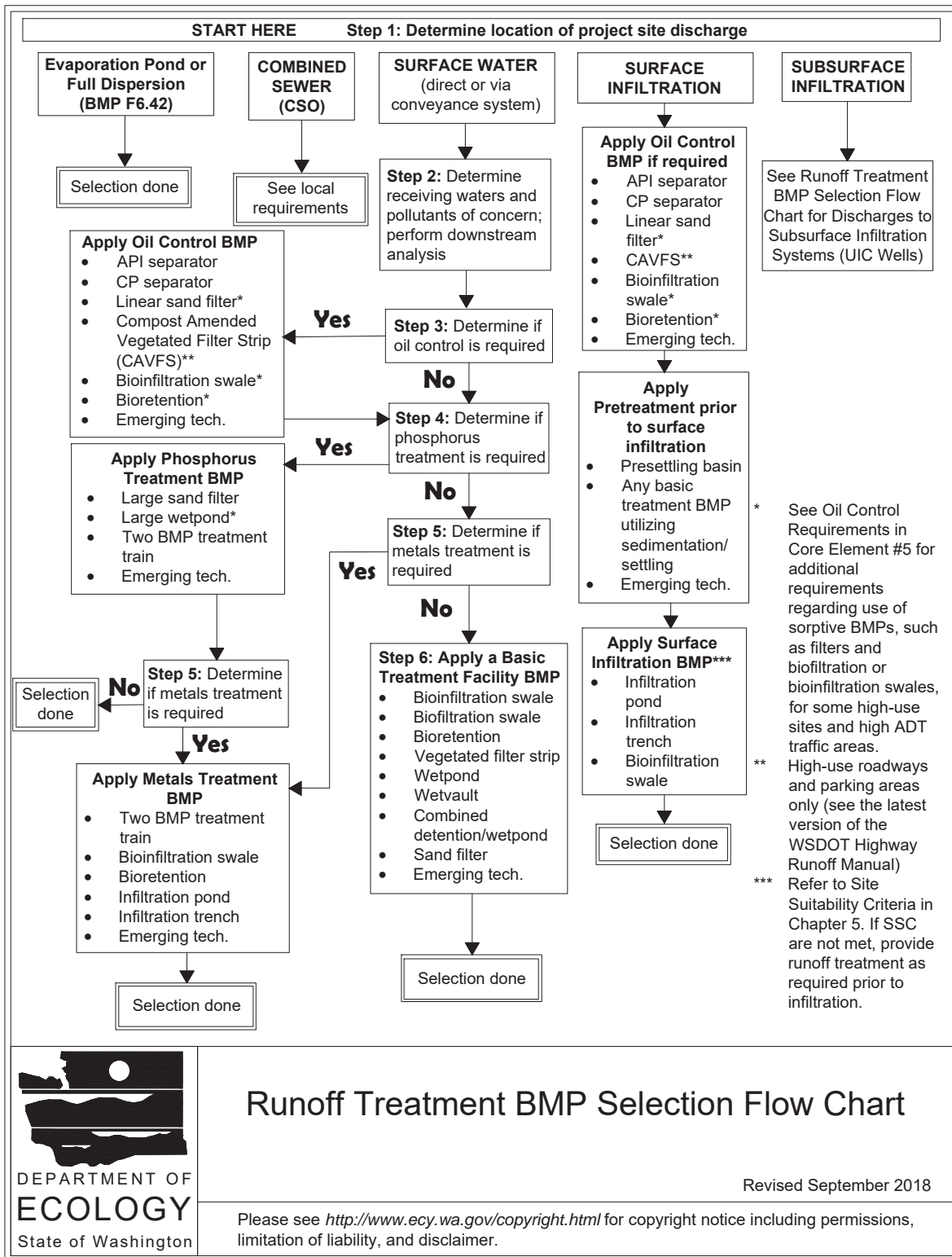
A six-step selection process is used to aid the designer in choosing the appropriate runoff treatment BMP for a particular project:

1. Determine the location of project site discharge:
  - a. Evaporation or Full Dispersion ([BMP F6.42: Full Dispersion](#))
  - b. Combined sanitary sewer
  - c. Surface water (directly or via conveyance system)

- d. Surface infiltration
  - e. Subsurface infiltration
2. If to surface water, determine the receiving waters and pollutants of concern based on off-site analysis.
  3. Determine if oil control BMP is required.
  4. Determine if phosphorus treatment is required.
  5. Determine if metals treatment is required.
  6. Select a basic treatment BMP (skip this step if phosphorus treatment or metals treatment is required).

**Note:** The process should be used in conjunction with [Figure 5.1: Runoff Treatment BMP Selection Flow Chart](#) and [Figure 5.2: Runoff Treatment BMP Selection Flow Chart for Discharges to Subsurface Infiltration Systems](#).

**Figure 5.1: Runoff Treatment BMP Selection Flow Chart**

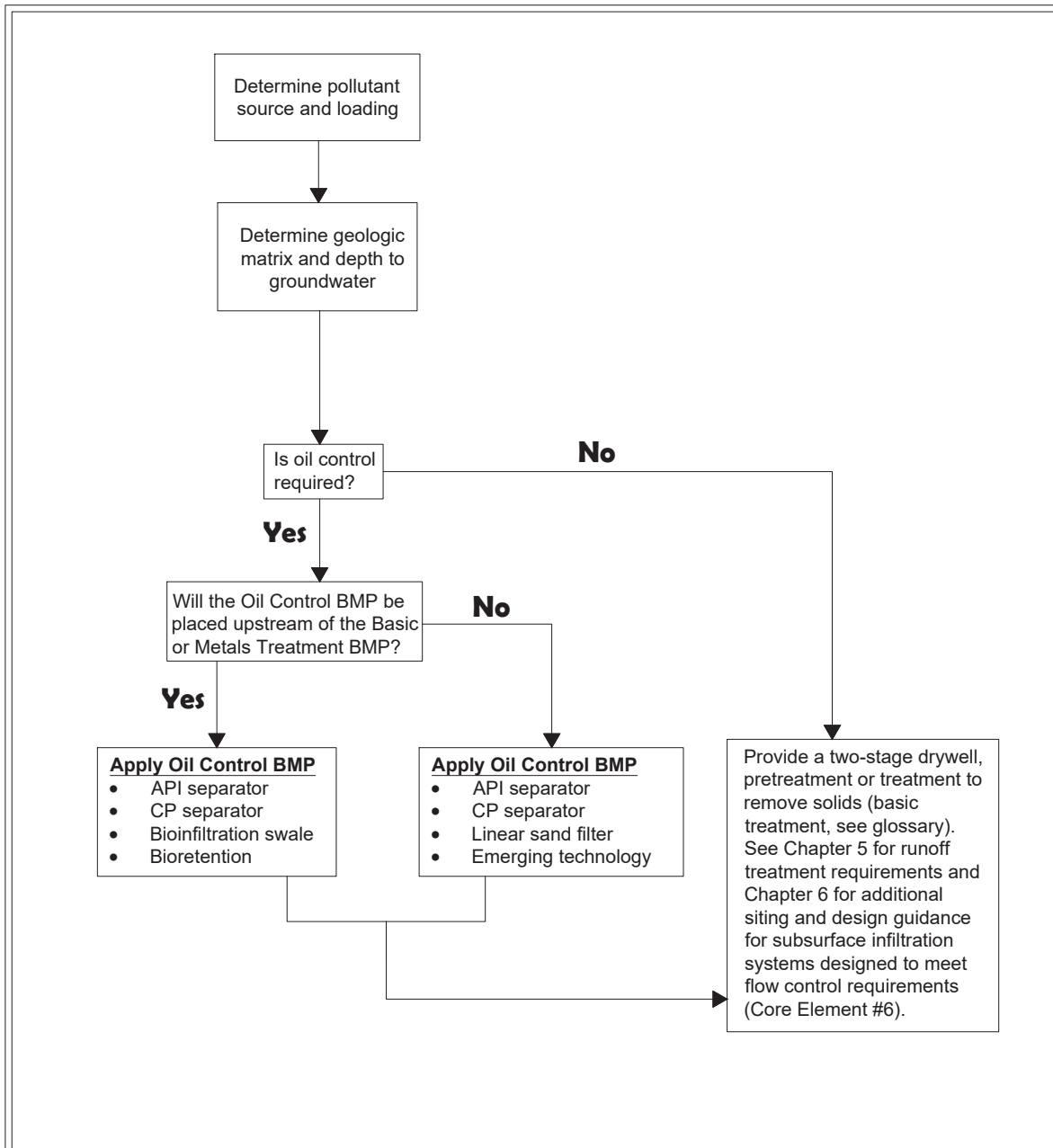


## Runoff Treatment BMP Selection Flow Chart

Revised September 2018

Please see <http://www.ecy.wa.gov/copyright.html> for copyright notice including permissions, limitation of liability, and disclaimer.

**Figure 5.2: Runoff Treatment BMP Selection Flow Chart for Discharges to Subsurface Infiltration Systems**



Runoff Treatment BMP Selection Flow Chart for  
Discharges to Subsurface Infiltration Systems  
(UIC Wells)

Revised September 2018

Please see <http://www.ecy.wa.gov/copyright.html> for copyright notice including permissions, limitation of liability, and disclaimer.

**Note:** See [Figure 5.1: Runoff Treatment BMP Selection Flow Chart](#) for a flow chart of the steps.

### **Step 1: Determine the Location of Project Site Discharge**

- A. Evaporation or Full Dispersion ([BMP F6.42: Full Dispersion](#)) (no additional treatment required)
- B. Combined sanitary sewer (no additional treatment required except as determined by local requirements)
- C. Surface waters (proceed to Step 2)
- D. Surface infiltration (proceed further with Step 1)
- E. Subsurface infiltration (proceed further with Step 1)

For discharges to surface infiltration or subsurface infiltration systems, see the infiltration treatment design criteria in [5.4.3 General Criteria for Infiltration and Bioinfiltration BMPs](#), [5.4.4 Screening Criteria for Infiltration BMPs](#), and [5.4.7 BMPs for Surface Infiltration and Bioinfiltration](#). If selecting infiltration-based BMPs for flow control, in addition to runoff treatment, also see the infiltration BMP criteria in [6.3 Infiltration BMPs](#). Infiltration can be effective at treating stormwater runoff, but soil properties must be appropriate to achieve effective treatment while not adversely impacting ground water resources. The location and depth to bedrock, the water table, or impermeable layers, and the proximity to wells, foundations, septic tank drain fields, and unstable slopes can preclude the use of infiltration.

For discharges to subsurface infiltration BMPs, such as underground injection control (UIC) wells, see [Figure 5.2: Runoff Treatment BMP Selection Flow Chart for Discharges to Subsurface Infiltration Systems](#) for the BMP selection process. One of the initial steps is to determine pollutant source and loading. The geologic matrix and depth to ground water should be determined using the criteria and guidance in [5.6 Subsurface Infiltration \(Underground Injection Control Wells\)](#). Using [Table 5.23: Treatment Required for Solids, Oil, and Metals](#), a determination is then made whether treatment is required prior to discharge. If treatment is required, appropriate controls are then selected, such as oil control, and/or other runoff treatment BMPs as applicable. See [6.3 Infiltration BMPs](#) for subsurface infiltration system siting and design guidance.

The local jurisdiction should verify whether any type of ground water quality management plans and/or local ordinances or regulations have been established such as ground water management plans or wellhead protection plans that identify required actions for stormwater discharges to protect ground water quality and/or quantity.

### **Step 2: Determine the Receiving Waters and Pollutants of Concern**

To obtain a more complete determination of the potential impacts of a stormwater discharge, Ecology encourages local jurisdictions to require an off-site analysis similar to that in [Chapter 3 - Preparation of Stormwater Site Plans](#). Also see [2.7.6 Core Element #5: Runoff Treatment](#). Even without an off-site analysis requirement, the project proponent must determine the natural receiving water for the stormwater drainage from the project site (e.g., wetland, lake, or stream). This is necessary to determine the applicable treatment menu from which to select treatment BMPs. The identification of the receiving water should be verified by the local jurisdiction with review respons-

ibility. If the discharge is to the local municipal drainage system, the receiving water for the drainage system must be determined.

The local jurisdiction should verify whether any type of water quality management plans and/or local ordinances or regulations have established specific requirements for the receiving waters. The project proponent needs to check all other agencies for requirements. Examples of plans to be aware of include the following:

- Watershed or basin plans: These can be developed to cover a wide variety of geographic scales (e.g., Water Resource Inventory Areas or subbasins of a few square miles) and can be focused solely on establishing stormwater requirements (e.g., “stormwater basin plans”) or can address a number of pollution and water quantity issues, including urban stormwater.
- Water cleanup plans: These plans are written to establish a Total Maximum Daily Load (TMDL) of a pollutant or pollutants in a specific receiving water or basin and to identify actions necessary to remain below that maximum loading. The plans may identify discharge limitations or management limitations (e.g., use of specific treatment BMPs) for stormwater discharges from new and redevelopment projects.
- Lake management plans: These plans are developed to protect lakes from eutrophication due to inputs of phosphorus from the drainage basin. Control of phosphorus from new development is a likely requirement in such plans.

An analysis of the proposed land use(s) of the project should also be used to determine the stormwater pollutants of concern. [Table 5.3: Typical Sources of Pollutants of Concern in Stormwater](#) lists the pollutants of concern from various land uses. [Table 5.4: Ability of Runoff Treatment BMPs to Remove Key Pollutants](#) indicates the ability of treatment BMPs to remove key pollutants. See [Table 5.3: Typical Sources of Pollutants of Concern in Stormwater](#) and [Table 5.4: Ability of Runoff Treatment BMPs to Remove Key Pollutants](#) for examples of treatment options after determining whether oil control, phosphorus treatment, metals treatment, or basic treatment applies to the project. Those decisions are made in the following steps.

### ***Step 3: Determine if Oil Control Is Required***

See [2.7.6 Core Element #5: Runoff Treatment](#) for a description of project sites that require oil control. If required, oil control BMPs shall be placed upstream of other BMPs, as close to the source of oil generation as practical. See [2.7.6 Core Element #5: Runoff Treatment](#) for a list of sites where separator technologies are allowed versus those for which sorptive technologies are required.

**Note:** Some land use types require the use of a spill control-type (SC-type) oil and water separator. Those situations are described in [Chapter 8 - Source Control](#) and are separate from this treatment requirement. While a number of activities may be required to use SC-type separators, only a few will necessitate American Petroleum Institute (API) or coalescing-plate-type (CP-type) separator for treatment. The following urban land uses are likely to have areas that fall within the definition of “high-use sites” or have sufficient quantities of free oil present that can be treated by an API, or CP-type, oil and water separator:

- Industrial machinery and equipment, and railroad equipment maintenance
- Log storage and sorting yards



- Aircraft maintenance areas
- Railroad yards
- Fueling stations
- Vehicle maintenance and repair facilities
- Construction businesses (paving, heavy equipment storage and maintenance, storage of petroleum products)

If oil control is required for the project site, select and apply the oil control BMP in accordance with [Figure 5.1: Runoff Treatment BMP Selection Flow Chart](#) and [Figure 5.2: Runoff Treatment BMP Selection Flow Chart for Discharges to Subsurface Infiltration Systems](#). Also see [5.3 General Requirements for Runoff Treatment BMPs](#) and [5.10 Oil and Water Separator BMPs](#). These requirements may affect the design and placement of BMPs on the site (e.g., flow splitting).

#### ***Step 4: Determine if Phosphorus Treatment Is Required***

The requirement to provide phosphorus treatment is determined by the local jurisdiction, the Washington State Department of Ecology (Ecology), or the U.S. Environmental Protection Agency. The local jurisdiction may have developed a management plan and implementing ordinances or regulations for control of phosphorus from new development and redevelopment for the receiving water(s) of the stormwater drainage. The local jurisdiction can use the following sources of information for pursuing plans and implementing ordinances and/or regulations:

- Water bodies reported under Section 305(b) of the Clean Water Act and designated as not supporting beneficial uses due to phosphorus
- Water bodies listed in Washington State’s Nonpoint Source Assessment required under Section 319(a) of the Clean Water Act due to nutrients

If phosphorus treatment is required, select and apply a phosphorus treatment BMP in accordance with [5.1.3 Runoff Treatment Methods and BMPs](#), [5.2.3 Other Treatment BMP Selection Factors](#), [5.3 General Requirements for Runoff Treatment BMPs](#), and [Figure 5.1: Runoff Treatment BMP Selection Flow Chart](#). [Table 5.3: Typical Sources of Pollutants of Concern in Stormwater](#) through [Table 5.8: Summary of BMP Applicability in Cold Regions](#) may also be used for initial screening of options.

**Note:** Project sites subject to the phosphorus treatment requirement could also be subject to the metals treatment requirement (see Step 5). In that event, apply a BMP or a treatment train that is listed in both the metals treatment menu and the phosphorus treatment menu in [5.1.3 Runoff Treatment Methods and BMPs](#) and [Figure 5.1: Runoff Treatment BMP Selection Flow Chart](#).

**Note:** If phosphorus treatment is required, Step 6 is not required.

#### ***Step 5: Determine if Metals Treatment Is Required***

Metals treatment is required for moderate- and high-use sites and sites that meet the definitions provided in the metals treatment requirements in [2.7.6 Core Element #5: Runoff Treatment](#) and discharge to a nonexempt surface water. If metals treatment is required, select and apply an appropriate metals treatment BMP in accordance with [5.1.3 Runoff Treatment Methods and BMPs](#),

[5.2.3 Other Treatment BMP Selection Factors](#), [5.3 General Requirements for Runoff Treatment BMPs](#), and [Figure 5.1: Runoff Treatment BMP Selection Flow Chart](#). [Table 5.3: Typical Sources of Pollutants of Concern in Stormwater](#) through [Table 5.8: Summary of BMP Applicability in Cold Regions](#) may also be used for initial screening of the options or parts of the two-BMP treatment trains.

**Note:** Project sites subject to the metals treatment requirement could also be subject to a phosphorus treatment requirement if located in an area designated for phosphorus control. In that event, apply a BMP or a treatment train that is listed in both the metals treatment menu and the phosphorus treatment menu.

**Note:** If metals treatment is required, Step 6 is not required.

### ***Step 6: Select a Basic Treatment BMP***

See [Table 5.3: Typical Sources of Pollutants of Concern in Stormwater](#) through [Table 5.8: Summary of BMP Applicability in Cold Regions](#) for initial screening of possible BMPs to satisfy the basic treatment requirement. After selecting a basic treatment BMP, see [5.3 General Requirements for Runoff Treatment BMPs](#), as these may affect the design and placement of the BMP on the project site.

## **5.2.3 Other Treatment BMP Selection Factors**

The selection of a treatment BMP should be based on pollutants of concern, site physical factors, and site context, as follows.

### ***Pollutants of Concern***

[Table 5.3: Typical Sources of Pollutants of Concern in Stormwater](#) summarizes the pollutants of concern and those land uses that are likely to generate pollutants. [Table 5.4: Ability of Runoff Treatment BMPs to Remove Key Pollutants](#) suggests treatment options for each pollutant. For example, oil and grease are the expected pollutants from an uncovered fueling station. Using [Table 5.3: Typical Sources of Pollutants of Concern in Stormwater](#), a combination of an oil and water separator and a biofiltration BMP could be considered as the basic treatment for runoff from uncovered fueling stations. [Table 5.4: Ability of Runoff Treatment BMPs to Remove Key Pollutants](#) provides a general indication of the relative effectiveness of classes of treatment BMPs in removing key stormwater pollutants.

### ***Site Physical Factors***

Site physical factors, including soil type, high sediment input, annual rainfall, and other physical factors that influence runoff treatment BMP selection, are summarized below.

#### **Soil Type**

The permeability of the soil underlying a runoff treatment BMP has a profound influence on its effectiveness. This is particularly true for infiltration treatment BMPs that are typically best sited in sandy to loamy sand soils. See the Site Suitability Criteria (SSC) in [5.4.3 General Criteria for Infiltration and Bioinfiltration BMPs](#) for soil criteria that must be considered for siting infiltration BMPs and check with the local jurisdiction for other possible requirements specific to local conditions. [Table 5.5:](#)

[Screening Treatment BMPs Based on Soil Type](#) presents a screening-level summary of appropriate runoff treatment BMP types based on soils underlying proposed BMP locations.

### **High Sediment Input**

High total suspended solids (TSS) loads can clog infiltration soil, sand filters, and coalescing plate oil and water separators. Pretreatment with a presettling basin, wetvault, or another basic treatment BMP would typically be necessary.

### **Climate Type**

Arid regions have annual rainfall < 16 inches and semiarid regions have annual rainfall from 16 to 35 inches. The amount of annual rainfall affects the effectiveness of BMPs that rely on vegetation for filter material or a pool of water for treatment. [Table 5.6: Recommended Stormwater Treatment BMPs Based on Climate Type](#) identifies the preferred BMPs and the limitations to use in the arid and semiarid climates found in most of eastern Washington.

**Table 5.3: Typical Sources of Pollutants of Concern in Stormwater**

Typical Sources of Pollutants of Concern in Stormwater	Typical Pollutants of Concern in Stormwater
<b>Roofs</b>	
Uncoated metal	Zn
Vents and emissions <sup>a</sup>	O&G, TSS, organics
<b>Parking Lot/Driveway</b>	
>High-use site	High O&G, TSS, Cu, Zn, PAHs
<High-use site	O&G, TSS
<b>Streets/Highways</b>	
Arterials/highways	O&G, TSS, Cu, Zn, PAHs
Residential collectors	Low O&G, TSS, Cu, Zn
High-use site intersections	High O&G, TSS, Cu, Zn, PAHs
<b>Other Sources</b>	
Industrial/commercial development	O&G, TSS, Cu, Zn
Residential development	TSS, pesticides/herbicides, nutrients
Uncovered fueling stations	High O&G
Industrial yards	High O&G, TSS, metals, PAHs

Notes for [Table 5.3: Typical Sources of Pollutants of Concern in Stormwater](#):

- Application of effective source control measures is the preferred approach for pollutant reduction. Where source control measures are not used, or where they are ineffective, stormwater treatment is necessary.

- Cu = copper
- O&G = oil and grease
- PAH = polycyclic aromatic hydrocarbons
- TSS = total suspended solids
- Zn = zinc
- <sup>a</sup>Manufacturing and food production.

**Table 5.4: Ability of Runoff Treatment BMPs to Remove Key Pollutants**

BMP	TSS	Dissolved Metals (e.g., Cu, Zn)	Total Phosphorus	Pesticides/Fungicides	Hydrocarbons (e.g., O&G, PAHs)
Wetpond	++	+	+		+
Wetvault	++				
Biofiltration	++	+	+	+	+
Sand Filter	++	+	+		+
Constructed Wetland	++	++	+	++	++
Leaf Compost Filters	++	+		++	++
Infiltration <sup>a</sup>	++	+		+	+
Oil and Water Separator					++
Bioinfiltration	++	++	+	++	++
Bioretention	++	++	++		++

Source: Adapted from [\(Kulzer, 1997\)](#). Additional BMPs with metals treatment benefits that are not included in the table are amended sand filters and two-BMP treatment trains; additional BMPs for phosphorus treatment are large sand filters, two-BMP treatment trains, and amended sand filters.

Notes for [Table 5.4: Ability of Runoff Treatment BMPs to Remove Key Pollutants](#):

- A blank cell indicates that the treatment BMP is not particularly effective at treating the identified pollutant.
- ++ Indicates a significant process
- + Indicates a lesser process
- Cu = copper

- O&G = oil and grease
- PAH = polycyclic aromatic hydrocarbons
- TSS = total suspended solids
- Zn = zinc
- <sup>a</sup>Assumes loamy sand, sandy loam, or loam soils.

**Table 5.5: Screening Treatment BMPs Based on Soil Type**

Soil Type	Infiltration/ Bioretention	Wetpond <sup>a</sup>	Bioinfiltration	Biofiltration <sup>a</sup> (e.g., Swale or Filter Strip)
Coarse Sand or Cobbles	–	–	–	–
Sand	+	–	–	–
Loamy Sand	+	–	+	+
Sandy Loam	+	–	+	+
Loam	–	–	+	+
Silt Loam	–	–	+	+
Sandy Clay Loam	–	+	–	+
Silty Clay Loam	–	+	–	–
Sandy Clay	–	+	–	–
Silty Clay	–	+	–	–
Clay	–	+	–	–

Notes for [Table 5.5: Screening Treatment BMPs Based on Soil Type](#):

- Sand filtration is not listed because its feasibility is not dependent on soil type.
- + Indicates that use of the technology is generally appropriate for this soil type.
- – Indicates that use of the technology is generally not appropriate for this soil type.
- <sup>a</sup>Coarser soils may be used for these BMPs if a liner is installed to prevent infiltration, or if the soils are amended to reduce the infiltration rate.

**Table 5.6: Recommended Stormwater Treatment BMPs Based on Climate Type**

Stormwater BMP	Arid Climates < 16 Inches Annual Rainfall	Semiarid Climates 16 to 35 Inches Annual Rainfall
Sand filters	Preferred: <ul style="list-style-type: none"> <li>• Requires greater pretreatment</li> <li>• Sensitive to sediment loadings</li> </ul>	Preferred
Bioinfiltration swales	Acceptable with Limitations: <ul style="list-style-type: none"> <li>• Use dryland grass</li> </ul>	Preferred: <ul style="list-style-type: none"> <li>• Use dryland or irrigated grass</li> </ul>
Bioretention	Acceptable with Limitations: <ul style="list-style-type: none"> <li>• Use dryland grass</li> </ul>	Preferred: <ul style="list-style-type: none"> <li>• Use dryland or irrigated grass</li> </ul>
Large extended detention dry ponds	Preferred: <ul style="list-style-type: none"> <li>• Multiple storm extended detention</li> <li>• Stable pilot channels</li> <li>• Dry forebay</li> </ul>	Acceptable: <ul style="list-style-type: none"> <li>• Dry or wet forebay needed</li> </ul>
Infiltration	Acceptable with Limitations: <ul style="list-style-type: none"> <li>• See <a href="#">Table 5.23: Treatment Required for Solids, Oil, and Metals</a></li> <li>• Minimize erodible soils that reduce infiltration</li> <li>• Pretreatment</li> <li>• Soil limitations</li> </ul>	Acceptable with Limitations: <ul style="list-style-type: none"> <li>• See <a href="#">Table 5.23: Treatment Required for Solids, Oil, and Metals</a></li> <li>• Minimize erodible soils that reduce infiltration</li> <li>• Pretreatment</li> </ul>
Wetponds	Not Recommended: <ul style="list-style-type: none"> <li>• Evaporation rates are too high to maintain a normal pond without extensive use of scarce water</li> </ul>	Limited Use: <ul style="list-style-type: none"> <li>• Liners to prevent water loss require water balance analysis design for a variable rather than permanent normal pool</li> <li>• Use water sources such as air conditioner condensate for pool</li> <li>• Aeration unit to prevent stagnation</li> </ul>
Stormwater wetlands	Not Recommended: <ul style="list-style-type: none"> <li>• Evaporation rates too great to maintain wetlands plants</li> </ul>	Limited Use: <ul style="list-style-type: none"> <li>• Require supplemental water</li> <li>• Submerged gravel wetlands can help reduce water loss</li> </ul>

**Table 5.6: Recommended Stormwater Treatment BMPs Based on Climate Type (continued)**

Stormwater BMP	Arid Climates < 16 Inches Annual Rainfall	Semiarid Climates 16 to 35 Inches Annual Rainfall
Biofiltration swales	Not Recommended: <ul style="list-style-type: none"> <li>• Not recommended for pollutant removal, but rock berms and grade control needed for open channels to prevent channel erosion</li> </ul>	Limited Use: <ul style="list-style-type: none"> <li>• Use dryland or irrigated grass</li> <li>• Rock berms and grade control essential to prevent erosion in open channels</li> </ul>
Source: Adapted from <a href="#">(Caraco, 2000)</a> .		

**Other Site Physical Factors**

- **Slope:** Steep site slopes restrict the use of several BMPs. A geotechnical/hydrologic evaluation should be done for sites on steeper slopes. See specific guidance for each BMP.
- **High water table:** Unless there is sufficient horizontal hydraulic receptor capacity, the water table acts as an effective barrier to exfiltration and can sharply reduce the efficiency of an infiltration system. If the high water table extends to within 5 feet of the bottom of an infiltration BMP, the site is seldom suitable.
- **Depth to limiting layer:** The downward exfiltration of stormwater is also impeded if a bedrock or till layer lies too close to the surface. If the impervious layer lies within 5 feet below the bottom of the infiltration BMP, the site is not suitable. Similarly, pond BMPs are often not feasible if bedrock lies within the area that must be excavated.
- **Proximity to foundations and wells:** The downward exfiltration of stormwater can be impeded by many different types of impervious limiting layers, including but not limited to bedrock, hardpan, till, or clay. This can be problematic if the BMP is located too close to a building foundation. Another risk is ground water pollution; hence the requirement to site infiltration systems > 100 feet from drinking water wells and outside the sanitary control area of public drinking water wells.

**Site Context**

Consider the location and surrounding site context to determine whether runoff treatment BMP design criteria and local jurisdiction requirements can be met. For instance, runoff treatment BMPs located in tight roadway right-of-way areas may have very different siting constraints than BMPs located in relatively open parking lots.

**5.2.4 Cold Weather Considerations**

**Objective**

This section presents cold weather considerations for BMP selection and design. Discussion and guidance are given in the following areas:

- Cold weather challenges to BMP design
- BMP applicability
- Snow and snowmelt considerations (see [4.3.9 Rain-on-Snow and Snowmelt Design](#))

### ***Cold Weather Challenges to BMP Design***

Cold climates can present additional challenges to the selection, design, and maintenance of runoff treatment BMPs due to one or more of the factors listed in [Table 5.7: Cold Weather Challenges to BMP Design](#). Designers of treatment BMPs in cold weather regions should be aware of these challenges and make provisions for them in their final designs.

Regions that have an average daily maximum temperature of  $\leq 35$  degrees Fahrenheit ( $^{\circ}\text{F}$ ) in January and a growing season  $< 120$  days are especially vulnerable to the effects of cold weather. These criteria indicate that these cold weather conditions exist in many parts of eastern Washington and are, therefore, an important design concern.

This section of the *Stormwater Management Manual for Eastern Washington* (manual) describes the general concerns common to most BMPs. Cold weather considerations specific to some individual BMPs are presented in the discussion of each methodology.



**Table 5.7: Cold Weather Challenges to BMP Design**

Climatic Conditions	BMP Design Challenge
Cold Temperatures	<ul style="list-style-type: none"> <li>• Pipe freezing</li> <li>• Permanent pool ice-covered</li> <li>• Reduced biological activity</li> <li>• Reduced oxygen levels during ice cover</li> <li>• Reduced settling velocities</li> <li>• Impacts of road salt/deicing chemicals/chlorides</li> <li>• Winter sanding impacts on BMPs</li> </ul>
Deep Frost Line	<ul style="list-style-type: none"> <li>• Frost heaving</li> <li>• Reduced soil infiltration</li> <li>• Pipe freezing</li> </ul>
Short Growing Season	<ul style="list-style-type: none"> <li>• Short time period to establish vegetation</li> <li>• Tolerance of plant species</li> </ul>
Significant Snowfall	<ul style="list-style-type: none"> <li>• High runoff volumes during snowmelt</li> <li>• High runoff during rain-on-snow</li> <li>• High pollutant loads during spring melt</li> <li>• Other impacts of road salt/deicing chemicals/chlorides</li> <li>• Snow management may affect BMP storage</li> <li>• Winter sanding impacts on BMPs</li> </ul>

Much of the following information has been adapted from Stormwater BMP Design Supplement for Cold Climates ([CWP, 1997](#)).

The recommendations presented in the report were customized in response to regional experiences for eastern Washington. However, since local experiences are often the best measure of BMP performance, designers should consult with the local jurisdiction before making a final decision on the inclusion of cold weather measures. Local jurisdictions should identify BMPs that work best in their areas as well as BMPs that are not allowable due to performance considerations.

As previously noted, [Table 5.6: Recommended Stormwater Treatment BMPs Based on Climate Type](#) contains information regarding the effects of climatic conditions on BMP design for arid and semiarid watersheds. For cold weather considerations, several of the most common effects are briefly described in the following sections. These discussions are not meant to address every

possible design detail that a designer may face when specifying an appropriate BMP for cold weather. The goal is to identify common BMP concerns such that the designer is aware of factors that might influence their designs.

### **Pipe Freezing**

Many BMPs rely on piping for the inlet, outlet, or underdrain system. Frozen pipes can crack due to ice expansion, creating a maintenance or replacement burden. In addition, pipe freezing reduces the capability of BMPs to treat runoff for water quality and can create the potential for flooding.

### **Ice Formation on Wetponds**

The permanent pool of a wetpond serves several purposes. First, the water in the permanent pool slows down incoming runoff, allowing increased settling. In addition, the biological activity in this pool can act to remove nutrients, as growing algae, plants, and bacteria require these nutrients for growth. In some systems, such as sand filters, a permanent pool acts as a pretreatment measure, settling out larger sediment particles before full treatment by the BMP.

Ice cover on the permanent pool causes two problems. First, the treatment pool's volume is reduced. Second, because the permanent pool is frozen, it acts as an impermeable surface. Runoff entering the pond will either be forced under the ice, causing scouring of the bottom sediments, or it will flow over the top of the ice, where it receives very little treatment.

### **Reduced Biological Activity**

Many BMPs rely on biological mechanisms to help reduce pollutants, especially nutrients and organic matter. In cold temperatures, microbial activity is sharply reduced when plants are dormant during longer winters, limiting these pollutant removal pathways.

### **Reduced Oxygen Levels in Bottom Sediments**

In cold regions, oxygen exchange between the air-water interface in ponds and lakes is restricted by ice cover. In addition, warmer water sinks to the bottom during ice cover because it is denser than the cooler water near the surface. Although biological activity is limited in cooler temperatures the decomposition that takes place does so at the bottom of wetponds, sharply reducing oxygen concentrations in bottom sediments. In these anoxic conditions, positive ions retained in sediments can be released from bottom sediments, reducing the BMPs ability to treat these nutrients or metals in runoff.

### **Reduced Settling Velocities**

Settling is the most important removal mechanism in many BMPs. As water becomes cooler, its viscosity increases, reducing the velocity of particle settling. This reduced settling velocity influences pollutant removal in any BMP that relies on settling.

### **Frost Heave**

The primary risk of frost heave is the damage of structures such as pipes or concrete materials to construct BMPs. Another concern is that infiltration BMPs can cause frost heave damage to other structures, particularly roads. The water infiltrated into the soil matrix can flow under a permanent structure and then refreeze. The sudden expansion associated with this freezing can cause damage to aboveground structures.

### **Reduced Soil Infiltration**

The rate of infiltration in frozen soils is limited, especially when ice lenses form. There are two results of this reduced infiltration. First, BMPs that rely on infiltration to function can be ineffective when the soil is frozen. Second, runoff rates from snowmelt are elevated when the ground underneath the snow is frozen.

### **Short Growing Season**

For some BMPs, such as bioinfiltration swales and biofiltration swales, vegetation is integral to the proper function of the BMP. When the growing season is shortened, establishing and maintaining this vegetation becomes more difficult. Some plant species go dormant at the onset of colder temperatures, reducing the pollutant removal efficiency in BMPs that rely on actively growing plant life.

### **High Pollutant Loading During Winter or Spring Thaw Periods**

Winter or spring melt events are important because of increased runoff volumes and pollutant loads. The snowpack contains high pollutant concentrations due to the buildup of pollutants over a several-month period. Chloride loadings are highest in snowmelt events because of the use of deicing salts, such as sodium chloride and magnesium chloride. Excessive loadings can kill vegetation in swales and other vegetative BMPs. Research indicates roughly 65% of the annual sediment, organic, nutrient, and lead loads can be attributed to winter and spring melts.

### **Snow Management – Plowing and Sanding**

Snow management can influence water quality and impact the selection of BMPs. Dumping snow into receiving waters is not allowed. Plowing snow onto pervious surfaces can help to decrease peak runoff rates and encourage infiltration. Snow with large amounts of sand, or bare surfaces with accumulated sand, however, can result in smothering or filling the capacity of stormwater BMPs.

### ***BMP Applicability***

Based on climate conditions and design obstacles, a list of BMP applicability in cold regions is presented in [Table 5.8: Summary of BMP Applicability in Cold Regions](#). Once again, these recommendations should be used as a rule-of-thumb rather than a hard and fast rule that can be applied in all instances. Also note that in order to meet the goal of treating at least 90% of the annual runoff volume, it may be necessary to oversize BMPs in cold regions.

**Table 5.8: Summary of BMP Applicability in Cold Regions**

Section No. and BMP No.	Applicability (High, Medium, Low)	Notes
<a href="#">5.4 Surface Infiltration and Bioinfiltration BMPs</a>		
<a href="#">BMP T5.10: Infiltration Ponds</a>	Medium	Can be effective but may be restricted by ground water quality concerns related to infiltration of chlorides. Frozen ground may inhibit the infiltration capacity of ground. Plants for vegetated BMPs should be selected for tolerance to cold and freezing conditions.
<a href="#">BMP T5.20: Infiltration Trenches</a>	Medium	
<a href="#">BMP T5.21: Infiltration Swales</a>	Medium	
<a href="#">BMP T5.30: Bioinfiltration Swales</a>	Medium	
<a href="#">BMP T5.31: Bioretention</a>	Medium	
<a href="#">5.5 Biofiltration BMPs</a>		
<a href="#">BMP T5.40: Biofiltration Swale</a>	Medium	Reduced effectiveness in the winter because of dormant vegetation. Very valuable for snow storage and meltwater infiltration.
<a href="#">BMP T5.50: Vegetated Filter Strip</a>	Medium	
<a href="#">5.6 Subsurface Infiltration (Underground Injection Control Wells)</a>		
Drywell	Medium to high	Infiltration surface below frost line.
<a href="#">5.7 Wetpool/Wetpond and Dry Pond BMPs</a>		
<a href="#">BMP T5.70: Basic Wetpond</a>	Medium	Can be effective but needs modifications to prevent freezing of outlet pipes. Limited by reduced treatment volume and biological activity during ice cover.
<a href="#">BMP T5.71: Large Wetpond</a>	High	Some modifications needed to conveyance structures. Extended detention storage provides treatment during winter season.
<a href="#">BMP T5.72: Wetvaults</a>	High	Design pool elevation below frost line or per manufacturer specs. Some modifications needed to conveyance structures.
<a href="#">BMP T5.73: Stormwater Treatment Wetland</a>	High	Extended detention storage provides treatment during winter season. Modifications needed to wetland plant species. Some modifications needed to conveyance structures.
<a href="#">BMP T5.74: Large Extended Detention Dry Pond</a>	Medium	Few modifications needed to adapt to cold climates. Not highly recommended because of relatively poor warm season performance.
<a href="#">5.8 Filtration BMPs</a>		
<a href="#">BMP T5.80: Basic Sand</a>	Low	Frozen ground considerations, combined with frost

**Table 5.8: Summary of BMP Applicability in Cold Regions (continued)**

Section No. and BMP No.	Applicability (High, Medium, Low)	Notes
<a href="#">Filter</a>		heave, make this ineffective in cold climates.
<a href="#">BMP T5.81: Large Sand Filter</a>	Low	
<a href="#">BMP T5.82: Sand Filter Vault</a>	High	Design filter elevation below frost line or per manufacturer specifications.
<a href="#">BMP T5.83: Linear Sand Filter</a>	Low to medium	Design filter elevation below frost line or per manufacturer specifications. Cold conditions may plug surface inlet and impact performance.
<a href="#">BMP T5.90: Evaporation Ponds</a>		
<a href="#">BMP T5.90: Evaporation Ponds</a>	Medium to high	Evaporation not expected to result in significant water losses during cold weather; hence must size to provide adequate storage.
<a href="#">5.10 Oil and Water Separator BMPs</a>		
<a href="#">BMP T5.100: API Separator Bay</a>	Low to medium	Check with the manufacturer for cold weather applicability.
<a href="#">BMP T5.110: Coalescing Plate (CP) Separator Bay</a>	Low to medium	

## 5.3 General Requirements for Runoff Treatment BMPs

### 5.3.1 Introduction to the General Requirements for Runoff Treatment BMPs

This section addresses general requirements for runoff treatment Best Management Practices (BMPs). Requirements discussed in this section include design volumes and flows, sequencing of BMPs, basic siting requirements, and maintenance criteria.

### 5.3.2 Design Volume and Flow

#### *Water Quality Design Storm Volume*

See [Chapter 4 - Hydrologic Analysis and Design](#) for information on design storms and the determination of peak flow rates and storm volumes.

#### *“Online” Versus “Off-Line” Systems*

Most runoff treatment BMPs can be designed as “online” systems with flows above the water quality design flow or volume simply passing through the BMP with lesser or no pollutant removal. An example of an online system is a biofiltration swale with overflow to a drywell.

However, it is sometimes desirable to control the peak flow rates to the BMPs and bypass the remaining uncontrolled flows around them. These are called “off-line” systems. An example of an off-line system is a biofiltration swale downstream of a flow splitter.

### ***Bypass Requirements***

A bypass or overflow structure must be provided for all runoff treatment BMPs unless the BMP is able to convey the 25-year short-duration storm without damaging the BMP or dislodging pollutants from within it. Bypass or overflow provisions must be provided for all flow-rate-based treatment BMPs and for volume-based runoff treatment BMPs that require them. See local requirements for typical designs.

To design a bypass for a flow-rate-based runoff treatment BMP:

1. Determine the maximum allowable velocity that will not result in damage of the BMP or dislodging of pollutants from within it.
2. Size an orifice or weir in a flow splitter manhole, vault, etc., such that the maximum velocity is not exceeded for the 25-year short-duration storm event.
3. Size the overflow (bypass) conveyance system for bypass flows.

To design a bypass for a volume-based runoff treatment BMP such as a bioinfiltration swale, maintain an elevated inlet or other overflow structure that bypasses flows above the design volume rather than using a flow-rate-based treatment BMP. The bypassed water may discharge to another runoff treatment BMP or directly into a drainage system or infiltration BMP.

Bypass is not recommended for wetponds, constructed wetlands, and similar volume-based treatment BMPs. Inlet structures for these BMPs should be designed to dampen velocities. The pond dimensions will further dissipate the energy of the inflows. In these BMPs, larger storms will be retained for a shorter detention time than the shorter storms for which the ponds are designed.

### ***Summary of Areas Needing Runoff Treatment***

All runoff from pollution-generating impervious surfaces (PGIS) meeting the thresholds for [2.7.6 Core Element #5: Runoff Treatment](#) shall be treated through runoff treatment BMPs. However, the BMPs must be sized to provide runoff treatment for all flows that are directed to them. For example, if a runoff treatment BMP receives flows from off-site non-pollution-generating pervious surfaces (NPGPS), the BMP must be sized to treat the runoff from those surfaces in addition to the runoff from the PGIS areas that are subject to [2.7.6 Core Element #5: Runoff Treatment](#).

### **5.3.3 Sequence of BMPs**

In general, all runoff treatment BMPs may be installed upstream of detention BMPs. However, not all runoff treatment BMPs can function effectively if located downstream of detention BMPs. BMPs that treat unconcentrated flows, such as filter strips, may be infeasible downstream of detention BMPs due to the concentrated discharge. Other types of runoff treatment BMPs present special problems that must be considered before placement downstream of detention. These would include biofiltration swales or sand filters, which are sensitive to saturation and continuous flow.

Oil control BMPs may be located upstream or downstream of runoff treatment BMPs. They should also be located as close to the source of oil-generating activity as possible and upstream of detention BMPs, wherever possible. See the related discussion of online versus off-line systems in [5.3.2 Design Volume and Flow](#).

### **5.3.4 Setbacks, Slopes, and Embankments**

The following guidelines for setbacks, slopes, and embankments are intended to provide for adequate maintenance accessibility to runoff treatment BMPs. Setback requirements are generally required by local regulations, Uniform Building Code requirements, or other state regulations. Local jurisdictions should require specific setback, slopes and embankment limitations to address public health and safety concerns.

#### **Setbacks**

Local jurisdictions may require specific setbacks in sites with steep slopes, landslide areas, open water features, springs, wells, and septic tank drain fields. Setbacks from tract lines are necessary for maintenance access and equipment maneuverability. Adequate room for maintenance equipment should be considered during site design.

Site Suitability Criterion 1 [SSC-1: Setback Criteria](#) provides setback criteria for infiltration BMPs. Local jurisdiction setback requirements may also apply.

#### **Side Slopes and Embankments**

- Side slopes should preferably not exceed a slope of 3H:1V. Moderately undulating slopes are acceptable and can provide a more natural setting for the BMP. In general, gentle side slopes improve the aesthetic attributes of the BMP and enhance safety.
- Interior side slopes may be retaining walls. The design shall be prepared and stamped by a licensed engineer in the state of Washington, when required by code. A fence should be provided along the top of the wall.
- Maintenance access should be provided through an access ramp or other adequate means.
- Embankments that impound water must comply with the Washington State Dam Safety Regulations ([Chapter 173-175 WAC](#)). If the impoundment has a storage capacity (including both water and sediment storage volumes)  $\geq 10$  acre-feet (435,600 cubic feet or 3.26 million gallons) above the natural ground level or has an embankment height of  $> 6$  feet at the downstream toe, then dam safety design and review are required by the Washington State Department of Ecology. See [6.2 Detention BMPs](#) for more detail concerning detention ponds.

### **5.3.5 Operation and Maintenance Criteria**

Each of the following BMP sections includes specific maintenance criteria the designer needs to be aware of when selecting that BMP. Recommended maintenance criteria for runoff treatment BMPs is included in [Appendix 5-A: Recommended Maintenance Criteria for Runoff Treatment BMPs](#).

## 5.4 Surface Infiltration and Bioinfiltration BMPs

### 5.4.1 Purpose

A stormwater infiltration Best Management Practice (BMP) is an impoundment, typically a pond, trench, or bioinfiltration swale whose underlying soil removes pollutants from stormwater. These BMPs serve the dual purpose of removing pollutants (total suspended solids [TSS], heavy metals, phosphates, and organics) from stormwater and recharging aquifers. Soils used for infiltration treatment must contain sufficient organic matter and/or clays to sorb, decompose, and/or filter stormwater pollutants. Pollutant/soil contact time, soil sorptive capacity, and soil aerobic conditions are important design considerations.

The following infiltration BMPs are described in this section:

- [BMP T5.10: Infiltration Ponds](#)
- [BMP T5.20: Infiltration Trenches](#)
- [BMP T5.21: Infiltration Swales](#)
- [BMP T5.30: Bioinfiltration Swales](#)
- [BMP T5.31: Bioretention](#)
- [BMP T5.32: Permeable Pavement](#)

### 5.4.2 Application

Infiltration and bioinfiltration BMPs are capable of achieving the performance objectives cited in [5.1 Introduction to Runoff Treatment BMP Design](#) for specific treatment menus. In general, these BMPs can capture and remove or reduce the target pollutants to levels that:

- Will not adversely affect public health or beneficial uses of surface and ground water resources; and
- Will not cause a violation of ground water quality standards.

An infiltration trench or bioinfiltration swale is preferred, but an infiltration basin may be more applicable where an infiltration trench or bioinfiltration swale cannot be sufficiently maintained. [Table 5.9: Applicability of Surface Infiltration and Bioinfiltration BMPs for Runoff Treatment, Flow Control, and Conveyance](#) summarizes the applicability of surface infiltration and bioinfiltration BMPs for runoff treatment, flow control, and conveyance.



**Table 5.9: Applicability of Surface Infiltration and Bioinfiltration BMPs for Runoff Treatment, Flow Control, and Conveyance**

BMP	Runoff Treatment					Flow Control	Conveyance
	Pretreatment	Basic	Metals	Oil Control	Phosphorus		
<a href="#">BMP T5.10: Infiltration Ponds</a>	✓	✓	✓			✓ <sup>a</sup>	
<a href="#">BMP T5.20: Infiltration Trenches</a>	✓	✓	✓			✓ <sup>b</sup>	
<a href="#">BMP T5.21: Infiltration Swales</a>	✓	✓	✓				
<a href="#">BMP T5.30: Bioinfiltration Swales</a>	✓	✓	✓	✓			
<a href="#">BMP T5.31: Bioretention</a>	✓	✓	✓	✓		✓ <sup>c</sup>	✓
<sup>a</sup> See <a href="#">BMP F6.21: Infiltration Ponds</a> <sup>b</sup> See <a href="#">BMP F6.22: Infiltration Trenches</a> <sup>c</sup> See <a href="#">BMP F6.23: Bioretention</a>							

### 5.4.3 General Criteria for Infiltration and Bioinfiltration BMPs

Discussed below are several considerations common to infiltration and bioinfiltration BMPs.

#### ***Design Infiltration Rate Determination***

See [Chapter 6 - Flow Control BMP Design](#) for information on determining infiltration rates. [Table 5.10: Infiltration Rates for Surface Infiltration and Bioinfiltration BMPs](#) can be used for determining presumptive infiltration rates for infiltration BMPs based on the U.S. Department of Agriculture (USDA) soil classification or the Unified Soil Classification System. See [6.B.3 Recommended Field Test Procedures](#) and [6.B.4 Recommended Laboratory Test Procedures](#) for additional guidance in determining infiltration rates.

**Table 5.10: Infiltration Rates for Surface Infiltration and Bioinfiltration BMPs**

USDA Soil Textural Classification	Unified Soil Classification System Group Symbol <sup>a</sup>	Presumptive Infiltration Rate (inches/hour)
Sand	SP-SM	Not suitable <sup>b</sup>
Sand	SP-SC	Not suitable <sup>b</sup>
Loamy Sand	SM, SC	2c
Sandy Loam	SM, SC	1c
Loam	ML, MH	0.5 <sup>c</sup>

Notes for [Table 5.10: Infiltration Rates for Surface Infiltration and Bioinfiltration BMPs](#):

- See [Appendix 6-B: Guidelines for Site Characterization of Geotechnical Properties](#) for alternative approaches to determining infiltration rates.
- <sup>a</sup> Groups contain from two to eight soil types distinguished by group name.
- <sup>b</sup> Not suitable for infiltration treatment unless justified by geotechnical study and approved by permitting municipality.
- <sup>c</sup> These infiltration rates are considered to be short-term infiltration rates. Site conditions, including depth to the water table, will affect the application of these rates in eastern Washington. Long-term infiltration rates are used for designing BMPs: a very general rule for determining the long-term infiltration rate is to divide the short-term infiltration rate by a factor of 2 to 4, depending on the soil classification and site conditions. A correction factor higher than 4 should be considered for situations where long-term maintenance will be difficult to implement, where little or no pretreatment is anticipated, or where site conditions are highly variable or uncertain. These situations require the use of best professional judgment by a licensed professional and may also require the approval of the local jurisdiction.

### **Pretreatment**

Infiltration BMPs must be preceded by a pretreatment BMP, such as a presettling basin or emerging technology, to reduce the occurrence of plugging. Any of the basic treatment BMPs (other than sand filters) designed to meet runoff treatment requirements or detention ponds designed to meet flow control requirements can also be used for pretreatment.

### **Site Suitability Criteria**

This section specifies the Site Suitability Criteria (SSC) that must be considered for siting infiltration BMPs. Check with the local jurisdiction for reporting requirements and other possible requirements specific to local conditions. When a site investigation reveals that any of the nine applicable criteria cannot be met, appropriate mitigation measures must be implemented so that the infiltration BMP will not pose a threat to human safety and health and the environment.

For infiltration treatment, site selection, and design decisions, a geotechnical report should be prepared by a licensed engineer in the state of Washington with geotechnical expertise, or a

hydrogeologic report should be prepared by a registered geologist in the state of Washington with hydrogeology specialty, if required by the SSC or local jurisdiction requirements.

The nine SSC are summarized in [Table 5.11: Site Suitability Criteria Applicability](#) and in the following subsections.

**Table 5.11: Site Suitability Criteria Applicability**

Site Suitability Criterion	Runoff Treatment	Flow Control
<a href="#">SSC-1: Setback Criteria</a>	✓	✓
<a href="#">SSC-2: Ground Water Protection Areas</a>	✓	✓
<a href="#">SSC-3: High Vehicle Traffic Areas</a>	✓	✓
<a href="#">SSC-4: Soil Infiltration Rate/Drawdown Time</a>	✓	✓
<a href="#">SSC-5: Depth to Bedrock, Ground Water Table, or Impermeable Layer</a>	✓	✓
<a href="#">SSC-6: Soil Physical and Chemical Suitability for Treatment</a>	✓	
<a href="#">SSC-7: Seepage Analysis and Control</a>	✓	✓
<a href="#">SSC-8: Cold Climate and Impact of Roadway Deicing Chemicals</a>	✓	✓
<a href="#">SSC-9: Previously Contaminated Soils or Unstable Soils</a>	✓	✓

**SSC-1: Setback Criteria**

The following setback criteria are provided as guidance to be implemented with respect to local regulations, Uniform Building Code requirements, or state regulations:

- Infiltration BMPs should be located outside the sanitary control area of public drinking water systems and > 100 feet from drinking water wells, septic tanks, and drain fields.
- Infiltration BMPs should be set back  $\geq$  200 feet from springs used for public drinking water supplies.
- Infiltration BMPs upgradient of drinking water supplies and within 1-, 5-, and 10-year time of travel zones of a public drinking water well must comply with local ordinances. To locate wellhead protection areas and the associated water purveyors in each county, see the Washington State Department of Health Source Water Assessment Program maps at the following website:

<https://fortress.wa.gov/doh/eh/dw/swap/maps/>

Information related to sole source aquifers and critical aquifer recharge areas, including requirements, is managed by the local jurisdiction.

- Additional setbacks should be considered if roadway deicing chemicals or herbicides are likely to be present in the influent to the infiltration system:
  - From building foundations:  $\geq 20$  feet downslope and 100 feet upslope
  - From a native growth protection easement (NGPE):  $\geq 20$  feet
  - From the top of slopes  $> 15\%$ :  $\geq 50$  feet or as determined by a licensed professional. Also check local critical area ordinances
- The design professional should carefully consider and evaluate any situation where a pond will be situated upslope from a structure or behind the top of a slope inclined  $> 15\%$ . The minimum setback from such a slope is equal to the height of the slope (h), unless the design professional can justify a lesser setback based on a comprehensive site evaluation.
- Evaluate on-site and off-site structural stability due to extended subgrade saturation and/or head loading of the permeable layer, including the potential impacts on downgradient properties, especially on hills with known hillside seeps.

### **SSC-2: Ground Water Protection Areas**

A site is not suitable if the infiltrated stormwater will cause a violation of the Washington State Department of Ecology's ground water quality standards ([Chapter 173-200 WAC](#)). Local jurisdiction staff and local ordinances should be consulted for applicable pretreatment requirements if the project site is located in an aquifer sensitive area, sole source aquifer, wellhead protection area, or critical aquifer recharge area.

### **SSC-3: High Vehicle Traffic Areas**

An infiltration BMP may be considered for runoff from areas of industrial activity and the high vehicle traffic areas described below. For such applications, sufficient pollutant removal (including oil removal) must be provided upstream of the infiltration BMP to ensure that ground water quality standards will not be violated and that the BMP is not adversely affected.

High vehicle traffic areas are the following:

- Commercial or industrial sites subject to an expected average daily traffic (ADT) count  $\geq 100$  vehicles/1,000 square feet (sf) gross building area (trip generation)
- Road intersections with an ADT of  $\geq 25,000$  on the main roadway, or  $\geq 15,000$  on any intersecting roadway

### **SSC-4: Soil Infiltration Rate/Drawdown Time**

*Infiltration Rates: Measured (Initial) and Design (Long-Term)*

For infiltration BMPs used for treatment purposes, the measured (initial) soil infiltration rate should be  $\leq 9$  inches per hour (in/hr). Design (long-term) infiltration rates up to 3 in/hr can also be considered, and in the judgment of the licensed professional, the treatment soil has characteristics comparable to those specified in SSC-6 to adequately control the target pollutants. Check for local requirements for infiltration rates.

#### *Drawdown Time*

It is necessary to empty the maximum ponded depth (water quality volume) from the infiltration basin within 72 hours from the completion of inflow to the storage pond in order to meet the following objectives:

- Restore hydraulic capacity to receive runoff from a new storm.
- Maintain infiltration rates.
- Aerate vegetation and soil to keep the vegetation healthy, prevent anoxic conditions in the treatment soils, and enhance the biodegradation of pollutants and organics.

#### **SSC-5: Depth to Bedrock, Ground Water Table, or Impermeable Layer**

The base of all infiltration basins or trench systems should be  $\geq 5$  feet above the seasonal ground water table, bedrock (or hardpan) or other low-permeability layer. A minimum separation of 3 feet may be considered if the ground water mounding analysis, volumetric receptor capacity, and the design of the overflow and/or bypass structures are judged by the licensed professional to be adequate to prevent overtopping and to meet the SSC specified in this section.

#### **SSC-6: Soil Physical and Chemical Suitability for Treatment**

Consider the soil texture and design infiltration rates along with the physical and chemical characteristics specified below to determine if the soil is adequate for removing the target pollutants. Perform the analysis of the soils below the bottom of the proposed infiltration BMP, regardless of the depth of the BMP. If an applicant proposes to use a deep UIC well, the soils analysis should show the adequacy of the deep soils. The following soil properties should be carefully considered in making such a determination:

- Cation exchange capacity (CEC) of the treatment soil must be  $\geq 5$  milliequivalents (meq) CEC/100 grams (g) dry soil (U.S. Environmental Protection Agency [U.S. EPA] Method 9081). Consider empirical testing of soil sorption capacity, if practicable. Ensure that soil CEC is sufficient for expected pollutant loadings, particularly heavy metals. CEC values of  $> 5$  meq/100 g are expected in loamy sands ([Buckman and Brady, 1969](#)). Lower CEC may be considered if it is based on a soil loading capacity determination for the target pollutants that is accepted by the local jurisdiction.
- Depth of treatment soil must be a minimum of 18 inches.
- Organic content of the treatment soil (ASTM D2974): Organic matter can increase the sorptive capacity of the soil for some pollutants. A minimum of 1% organic content is necessary.
- Waste fill materials should not be used as infiltration soil media nor should such media be

placed over uncontrolled fill soils.

- A minimum depth of 6 inches of sand meeting the sand filter specification ([Table 5.29: Sand Media Specification](#)) may be used for bioinfiltration swales. Field performance evaluation(s), using acceptable protocols, would be needed to determine feasibility and acceptability by the local jurisdiction.
- Local jurisdictions may establish preapproved soil types for treatment suitability. Check locally for specific allowances and requirements.

### **SSC-7: Seepage Analysis and Control**

Determine whether there would be any adverse effects caused by seepage zones on nearby building foundations, basements, roads, parking lots, or sloping sites.

### **SSC-8: Cold Climate and Impact of Roadway Deicing Chemicals**

Consider the potential impact of roadway deicing chemicals dissolved within infiltrated stormwater on potable water wells in the siting determination. Implement mitigation measures if the infiltration of roadway deicing chemicals could cause a violation of ground water quality standards.

### **SSC-9: Previously Contaminated Soils or Unstable Soils**

Infiltration of stormwater is not recommended on or upgradient of contaminated sites where infiltration of even clean water can cause contaminants to mobilize. If the site is known or suspected to contain contaminated soils, the design professional should investigate whether the soil under the proposed infiltration BMP contains contaminants that could be transported by infiltrated water from the BMP. If so, measures should be taken for remediation of the site prior to construction of the BMP, or an alternative location should be chosen. The design professional should also determine if the site history, regional geology or local geology indicates that the soil beneath the proposed infiltration BMP could be unstable, due to improper placement of fill, subsurface geologic features, etc. If so, further investigation and planning should be undertaken prior to siting of the BMP.

### ***Sizing Criteria***

Size should be determined by using the method(s) outlined with each BMP, based on the requirement of infiltrating the water quality design storm volume within 72 hours after cessation of flow.

### ***Construction Criteria***

- **Excavation:** Initial excavation should be conducted to within 1 foot of the final elevation of the floor of the infiltration BMP. Final excavation to the finished grade should be deferred until all disturbed areas in the upgradient watershed have been stabilized or protected. The final phase of excavation should remove all accumulated sediment. After construction is completed, prevent sediment from entering the infiltration BMP by first conveying the runoff water through an appropriate pretreatment system such as a presettling basin, wetpond, or sand filter.
- **Sediment traps:** Infiltration BMPs should generally not be used as temporary sediment traps

during construction. If an infiltration BMP is to be used as a sediment trap, it must not be excavated to final grade until after the upgradient contributing area has been stabilized. Any accumulation of silt in the basin must be removed before putting it in service.

- **Traffic control:** Relatively light-tracked equipment is recommended for excavation to avoid compaction of the floor of the infiltration BMP. The use of draglines and trackhoes should be considered. The infiltration area should be flagged or marked to keep equipment away.

### **Operation and Maintenance Criteria**

- Provision should be made for regular and perpetual maintenance of the infiltration BMPs. Maintenance should be conducted when water remains in the ponded portion of the BMP for > 72 hours.
- Adequate access for maintenance must be included in the design of infiltration basins and trenches. An operation and maintenance manual, approved by the local jurisdiction, should ensure maintaining the desired efficiency of the infiltration BMP.
- Removal of accumulated debris/sediment in the basin/trench should be conducted every 6 months or as needed to prevent clogging, or when water remains in the pond > 72 hours.
- The treatment soil should be replaced or amended as needed to ensure it is maintaining adequate treatment capacity.
- See [Appendix 5-A: Recommended Maintenance Criteria for Runoff Treatment BMPs](#) for recommended maintenance criteria.

### **Verification of Performance**

During the first 1 to 2 years of operation, verification monitoring is strongly recommended. The professional engineer should monitor the construction of the infiltration BMP to ensure that the work is completed in compliance with the designer's intent and the plans and specifications. Following construction, the BMP should be visually monitored quarterly over a 2-year period to assess its performance as designed. Operating and maintaining ground water monitoring wells is also strongly encouraged.

### **5.4.4 Screening Criteria for Infiltration BMPs**

The following screening criteria describe conditions that make infiltration BMPs infeasible or inefficient. If a project triggers any of the below-listed screening criteria, yet the project proponent wishes to use infiltration BMPs, they may propose a functional design that effectively mitigates these issues to the local jurisdiction. These screening criteria should be evaluated based on site-specific conditions by a licensed professional.

**Note:** For bioretention, criteria with setback distances are as measured from the bottom edge of the bioretention soil media, under the following conditions.

- Where professional geotechnical evaluation recommends infiltration not be used due to reasonable concerns about erosion, slope failure, or downgradient flooding.
- Within an area where ground water drains into an erosion hazard, or landslide hazard area.

- Where the only area available for siting would threaten the safety or reliability of preexisting underground utilities, preexisting underground storage tanks, preexisting structures, or preexisting road or parking lot surfaces.
- Where the only area available for siting does not allow for a safe overflow pathway.
- Where there is a lack of usable space for infiltration BMPs at redevelopment sites, or where there is insufficient space within the existing public right-of-way on public road projects.
- Where infiltrating water would threaten existing below grade basements.
- Where infiltrating water would threaten shoreline structures.
- Where treatment soils containing compost amendments for treatment prior to infiltration would exacerbate phosphorus loading to phosphorus-sensitive receiving waters.
- Within setbacks from structures as established by the local jurisdiction.
- Where they are not compatible with surrounding drainage system as determined by the local jurisdiction (e.g., project drains to an existing drainage system where the elevation or location precludes connection to a properly functioning bioretention BMP).
- Where land for infiltration BMPs is within area designated as an erosion hazard, or landslide hazard.
- Within 50 feet from the top of slopes that are > 20% and > 10 feet of vertical relief.
- For properties with known soil or ground water contamination (typically federal Superfund sites or state cleanup sites under the Model Toxics Control Act (MTCA):
  - Within 100 feet of an area known to have deep soil contamination
  - Where ground water analysis indicates infiltration will likely increase or change the direction of the migration of pollutants in the ground water
  - Wherever surface soils have been found to be contaminated unless those soils are removed within 10 horizontal feet from the infiltration area
  - Any area where these BMPs are prohibited by an approved cleanup plan under the state MTCA or federal Superfund Law, or an environmental covenant under [Chapter 64.70 RCW](#)
- Within 100 feet of a closed or active landfill.
- Within 100 feet of a drinking water well, within the sanitary control area of a public drinking water well, or within 200 feet of a spring used for drinking water supply.
- Within 10 feet of small on-site sewage disposal drain field, including reserve areas, and grey water reuse systems. For setbacks from a “large on-site sewage disposal system,” see [Chapter 246-272B WAC](#).
- Within 10 feet of an underground storage tank and connecting underground pipes when the capacity of the tank and pipe system is 1,100 gallons or less. (As used in these criteria, an



underground storage tank means any tank used to store petroleum products, chemicals, or liquid hazardous wastes of which  $\geq 10\%$  of the storage volume [including volume in the connecting piping system] is beneath the ground surface.)

- Within 100 feet of an underground storage tank and connecting underground pipes when the capacity of the tank and pipe system is  $> 1,100$  gallons.
- Where the minimum vertical separation of 1 foot to the seasonal high ground water table, bedrock, or other impervious layer would not be achieved below infiltration BMPs that would serve a contributing area that is (1)  $< 5,000$  sf of pollution-generating impervious surface (PGIS), (2)  $< 10,000$  sf of impervious surface, and (3)  $< 0.75$  acres of pervious surface.
- Where a minimum vertical separation of 3 feet to the seasonal high ground water table, bedrock or other impervious layer would not be achieved below bioretention that (1) would serve a contributing area that meets or exceeds (a) 5,000 sf of PGIS, (b) 10,000 sf of impervious surface, or (c) 0.75 acres of pervious surfaces; and (2) cannot reasonably be broken down into amounts smaller than those indicated in No. 1.
- Where the field testing indicates potential infiltration sites have a long-term native soil saturated hydraulic conductivity ( $K_{sat}$ )  $< 0.5$  in/hr. If the measured native soil infiltration rate is  $< 0.5$  in/hr, an infiltration BMP with an underdrain may be used to treat pollution-generating surfaces to help meet [2.7.6 Core Element #5: Runoff Treatment](#). If the underdrain is elevated within a base course of gravel, it will also provide some modest flow reduction benefit that will help achieve [2.7.7 Core Element #6: Flow Control](#).

The BMPs discussed below are recognized currently as effective treatment techniques using infiltration and bioinfiltration. Selection of a specific BMP will depend on having followed the runoff treatment BMP selection process described in [5.2 Runoff Treatment BMP Selection Process](#).

### **5.4.5 Cold Weather Climate Considerations**

Surface infiltration and bioinfiltration BMPs can be effective in cold climates, but may be restricted by ground water quality concerns related to infiltration of chlorides. Frozen ground may inhibit the infiltration capacity of the ground. Grasses or other vegetation used in vegetated surface infiltration and bioinfiltration BMPs may also be dormant or ineffective at providing treatment mechanisms (e.g., filtration, pollutant uptake, etc.) during the winter. For vegetated BMPs, plants shall be selected to be tolerant of cold and freezing climates. See [5.2.4 Cold Weather Considerations](#) for additional cold weather considerations.

### **5.4.6 Arid/Semiarid Climate Considerations**

For vegetated BMPs in arid/semiarid portions of eastern Washington, plants should be selected to be drought tolerant and not require watering after establishment (2 to 3 years). In more arid environments, watering may be needed during prolonged dry periods after plants are established. See [Table 5.6: Recommended Stormwater Treatment BMPs Based on Climate Type](#) for additional considerations based on average annual rainfall.

## 5.4.7 BMPs for Surface Infiltration and Bioinfiltration

### BMP T5.10: Infiltration Ponds

Infiltration ponds are earthen impoundments used for the collection, temporary storage, and infiltration of incoming stormwater runoff.

Design of infiltration ponds for runoff treatment is identical to the criteria given for [BMP F6.21: Infiltration Ponds](#), except that the allowable infiltration rate is limited to  $\leq 9$  inches per hour.

Underground Injection Control (UIC) regulations do not apply to infiltration ponds unless the pond is deeper than it is wide at the ground surface, and then—provided that the design, operation, and maintenance criteria in this section are met—only the registration requirement would apply. See [5.6 Subsurface Infiltration \(Underground Injection Control Wells\)](#).

See the Site Suitability Criteria for all infiltration BMPs in [5.4.3 General Criteria for Infiltration and Bioinfiltration BMPs](#).

### BMP T5.20: Infiltration Trenches

Infiltration trenches are trenches, generally  $\geq 24$  inches wide, with a perforated pipe and backfilled with a coarse rock aggregate, allowing for temporary storage of stormwater runoff in the voids of the aggregate material. Stored runoff then gradually infiltrates into the surrounding soil. The surface of the trench can be covered with grating and/or consist of stone, gabion, sand, or a grassed or asphalt area with a surface inlet. Perforated rigid pipe of at least 8-inch diameter can also be used to distribute the stormwater in an infiltration trench.

The design of infiltration trenches for runoff treatment is identical to the criteria given for [BMP F6.22: Infiltration Trenches](#), except that the allowable infiltration rate is limited to  $\leq 9$  inches per hour.

Infiltration chambers may be used to augment the available storage in the infiltration trench system, where the perforated pipe and the voids within the coarse rock aggregate backfill layer would not provide sufficient storage to meet flow control requirements for [2.7.7 Core Element #6: Flow Control](#).

Underground Injection Control (UIC) regulations apply to infiltration trenches when perforated pipe is used, and then—provided that the design, operation, and maintenance criteria in this section are met—only the registration requirement applies. When perforated pipe is not used, the registration requirement does not apply. See [5.6 Subsurface Infiltration \(Underground Injection Control Wells\)](#).

**For more information:** See the Site Suitability Criteria for all infiltration BMPs in [5.4.3 General Criteria for Infiltration and Bioinfiltration BMPs](#).

### BMP T5.21: Infiltration Swales

Infiltration swales are vegetated or rock-lined conveyances designed for removal of stormwater pollutants by percolation into the ground.

Underground Injection Control (UIC) regulations do not apply to these Best Management Practices (BMPs) (see [5.6 Subsurface Infiltration \(Underground Injection Control Wells\)](#)).

## General Criteria

Use the general criteria for [BMP T5.30: Bioinfiltration Swales](#), with the following exceptions:

- Amended soil may be required to meet [SSC-6: Soil Physical and Chemical Suitability for Treatment](#).
- For rock-lined infiltration swales, a minimum treatment soil depth of 18 inches is required for runoff treatment because there is no uptake by vegetation.

Infiltration swales should be preceded by a pretreatment BMP, such as a presettling basin or vault, to reduce the occurrence of plugging. Any of the basic treatment BMPs (other than sand filters) designed to meet runoff treatment requirements or detention ponds designed to meet flow control requirements can also be used for pretreatment.

For vegetated infiltration swales in arid or semiarid climate portions of eastern Washington, xeriscape landscaping is strongly encouraged to reduce the need for irrigation and better fit the surrounding site context. See [Appendix 5-B: Planting Recommendations](#) for additional information on selecting and installing xeriscape and other plantings.

Select appropriate rock, such as large 3- or 5-inch river rock or crushed basalt, for rock-lined swales to facilitate maintenance and help with dust and erosion control.

## Design Procedure

The design of infiltration swales for runoff treatment is identical to that of [BMP T5.30: Bioinfiltration Swales](#) with the exceptions noted above in the general criteria for this BMP.

## BMP T5.30: Bioinfiltration Swales

Bioinfiltration swales, also known as grassed percolation areas, combine grasses (or other vegetation) and soils to remove stormwater pollutants by percolation into the ground. Their pollutant removal mechanisms include filtration, soil sorption, and uptake by vegetated root zones.

In general, bioinfiltration swales are used for treating stormwater runoff from roofs, roads, and parking lots. For flow control, flows greater than the water quality design flows are typically overflowed to the subsurface through an appropriate conveyance BMP such as a drywell, or to surface water through an overflow channel. Note that although the Underground Injection Control (UIC) regulations do not apply to bioinfiltration swales; however, the UIC regulations do apply to any drywell used in connection with the bioinfiltration swale (see [5.6 Subsurface Infiltration \(Underground Injection Control Wells\)](#)).

## General Criteria

- Use the same sizing guidance, off-line and online guidance, and design procedures as in [6.3.3 General Criteria for Infiltration BMPs](#).
- The maximum drawdown time for the flooded depth should be within 72 hours after cessation of flow.
- A concrete or riprap apron shall be provided at the curb opening to prevent vegetation from blocking the inlet.

- Unless check dams are used, the swale bottom should be relatively flat with a longitudinal slope < 1%.
- Slopes > 2.5% need check dams (riprap) at vertical drops of 12 to 15 inches.
- The maximum flood depth of swale should be 6 inches, prior to overflow to a drywell or other infiltrative or overflow BMP.
- The volume contained by the swale must be sufficient for the water quality volume to be treated prior to overflow or infiltration.
- Treatment soils:
  - The treatment soil should be ≥ 6 inches thick with a cation exchange capacity (CEC) of ≥ 5 milliequivalents (meq)/100 grams (g) dry soil, organic content of ≥ 1%, and sufficient target pollutant-loading capacity ([Miller, 2000](#)).
  - Other combinations of treatment soil thickness, CEC, and organic content design factors can be considered if it is demonstrated that the soil and vegetation will provide a target pollutant-loading capacity and performance level acceptable to the local jurisdiction.
  - The treatment soil depth of 6 inches or more should contain sufficient organics and texture to ensure good growth of the vegetation.
  - The average infiltration rate of the 6-inch-thick layer of treatment soil should not exceed 3 inches per hour (in/hr) for a system relying on the root zone to enhance pollutant removal. Furthermore, a maximum infiltration rate of 9 in/hr is applicable and the Site Suitability Criteria (SSC) in [5.4.3 General Criteria for Infiltration and Bioinfiltration BMPs](#) must also be applied.
- Native grasses, adapted grasses, or other vegetation with significant root mass should be used per [Appendix 5-B: Planting Recommendations](#). Grasses should be drought tolerant or irrigation should be provided.
- Pretreatment may be used to prevent the clogging of the treatment soil and/or vegetation by debris, total suspended solids (TSS), and oil and grease.

Identify pollutants, particularly in industrial and commercial area runoff, that could cause a violation of Washington State Department of Ecology's ground water quality standards ([Chapter 173-200 WAC](#)). Include appropriate mitigation measures (pretreatment, source control, etc.) for those pollutants.

## ***Design Procedure***

Bioinfiltration swales may be sized using several different design methods. Each of the approaches is valid in the context of the *Stormwater Management Manual for Eastern Washington* (manual), although the local jurisdiction may, at its option, direct the designer to use a particular method.

### **Method 1 – Prescribed Volume Based on Rainfall and Design Infiltration Rate**

This method prescribes a set runoff volume to be used in calculating the treatment volume of the bioinfiltration swale, based on the 2-year 24-hour precipitation at the site and the design infiltration rate. [Table 5.12: Bioinfiltration Swale Sizing Table for Design Infiltration Rates in the Range of 0.15 to 0.40 Inches/Hour](#) and [Table 5.13: Bioinfiltration Swale Sizing Table for Design Infiltration Rates in the Range of 0.41 to 1.00 Inches/Hour](#) illustrate the amount of runoff from 1,000 square feet (sf) of contributing area for various regions of eastern Washington for design infiltration rates of 0.15 to 0.40 in/hr and 0.41 to 1.00 in/hr, respectively. The appropriate value for the site may be used to calculate the required volume of the bioinfiltration swale as follows:

**Equation 5.1: Bioinfiltration Swale Volume (Method 1)**

$$V = A * R / 1,000$$

where:

V = volume of the bioinfiltration swale (cubic feet [cf])

A = area draining to bioinfiltration swale (sf)

R = runoff volume ratio shown in the third column of [Table 5.12: Bioinfiltration Swale Sizing Table for Design Infiltration Rates in the Range of 0.15 to 0.40 Inches/Hour](#) (for sites with design infiltration rates between 0.15 and 0.40 in/hr) or [Table 5.13: Bioinfiltration Swale Sizing Table for Design Infiltration Rates in the Range of 0.41 to 1.00 Inches/Hour](#) (for sites with design infiltration rates between 0.41 and 1.00 in/hr)

**Table 5.12: Bioinfiltration Swale Sizing Table for Design Infiltration Rates in the Range of 0.15 to 0.40 Inches/Hour**

2-Year 24-Hour Precipitation (inches)		Swale Volume per 1,000 Square Feet of Area (R)	Examples of Applicable Sites
From	To		
0.60	0.80	29.2 cubic feet	Moses Lake
0.81	1.00	37.5 cubic feet	Yakima, Kennewick
1.01	1.20	45.8 cubic feet	Wenatchee, Walla Walla
1.21	1.40	55.8 cubic feet	Colfax, Colville
1.41	1.55	61.3 cubic feet	Lowlands Blue Mountains
1.56	> 1.56r	Method 3 required	Eastern and Cascade Mountains

**Table 5.13: Bioinfiltration Swale Sizing Table for Design Infiltration Rates in the Range of 0.41 to 1.00 Inches/Hour**

2-Year 24-Hour Precipitation (inches)		Swale Volume per 1,000 Square Feet of Area (R)	Examples of Applicable Sites
From	To		
0.60	0.80	19.6 cubic feet	Moses Lake
0.81	1.00	25.4 cubic feet	Yakima, Kennewick
1.01	1.20	27.9 cubic feet	Wenatchee, Walla Walla
1.21	1.40	33.8 cubic feet	Colfax, Colville
1.41	1.55	36.7 cubic feet	Lowlands Blue Mountains
1.56	> 1.56	Method 3 required	Eastern and Cascade Mountains

**Method 2 – First 0.5 Inches of Runoff**

This method uses the first 0.5 inches of runoff from impervious surfaces to size the bioinfiltration swale. This method is applicable only in Climate Regions 2 and 3.

**Equation 5.2: Bioinfiltration Swale Volume (Method 2)**

$$V = (A * 0.5 \text{ inch}) / 12 \text{ inches per foot (in/ft)}$$

where:

V = Volume of the bioinfiltration swale (cf)

A = Area needing treatment that drains to the bioinfiltration swale (sf)

This method does not give credit for infiltration through the bottom of the swale.

The treatment depth is typically 6 inches. A maximum treatment depth of 8 inches is allowed if CEC testing indicates that CEC is  $\geq 15$  meq/100 g. CEC testing can be completed after construction, or a soil amendment that meets the CEC requirements can be specified on the construction drawings. The swale is sized to store the required runoff volume (using the design storm established by the local jurisdiction; the 25-year Soil Conservation Service (SCS) Type IA storm is the default design storm) generated by the contributing basin. The swale is sized using the entire swale depth, typically no deeper than 1 foot, in conjunction with a subsurface infiltration BMP such as a drywell.

**Method 3 – Hydrologic Analysis**

This method uses hydrologic models, such as SCS or Santa Barbara Urban Hydrograph (SBUH), to determine the quantity of runoff from the water quality design storm and then route the flow through the infiltration BMP, assuming the long-term infiltration rate is used for the outflow calculations. This method is required in areas with > 1.56 inches of rainfall in the 2-year, 24-hour storm and is allowed in all other areas with the approval of the local jurisdiction.

**For more information:** See [Chapter 4 - Hydrologic Analysis and Design](#) for more information on hydrologic analysis methods.

## **BMP T5.31: Bioretention**

The term bioretention describes a stormwater management practice that uses the chemical, biological, and physical properties of plants, soil microbes, and the mineral aggregate and organic matter in soils to transform, remove, or retain pollutants from stormwater runoff. Numerous design variations have evolved since the advent of this Best Management Practice (BMP); however, there are fundamental design characteristics that define bioretention BMPs across various settings:

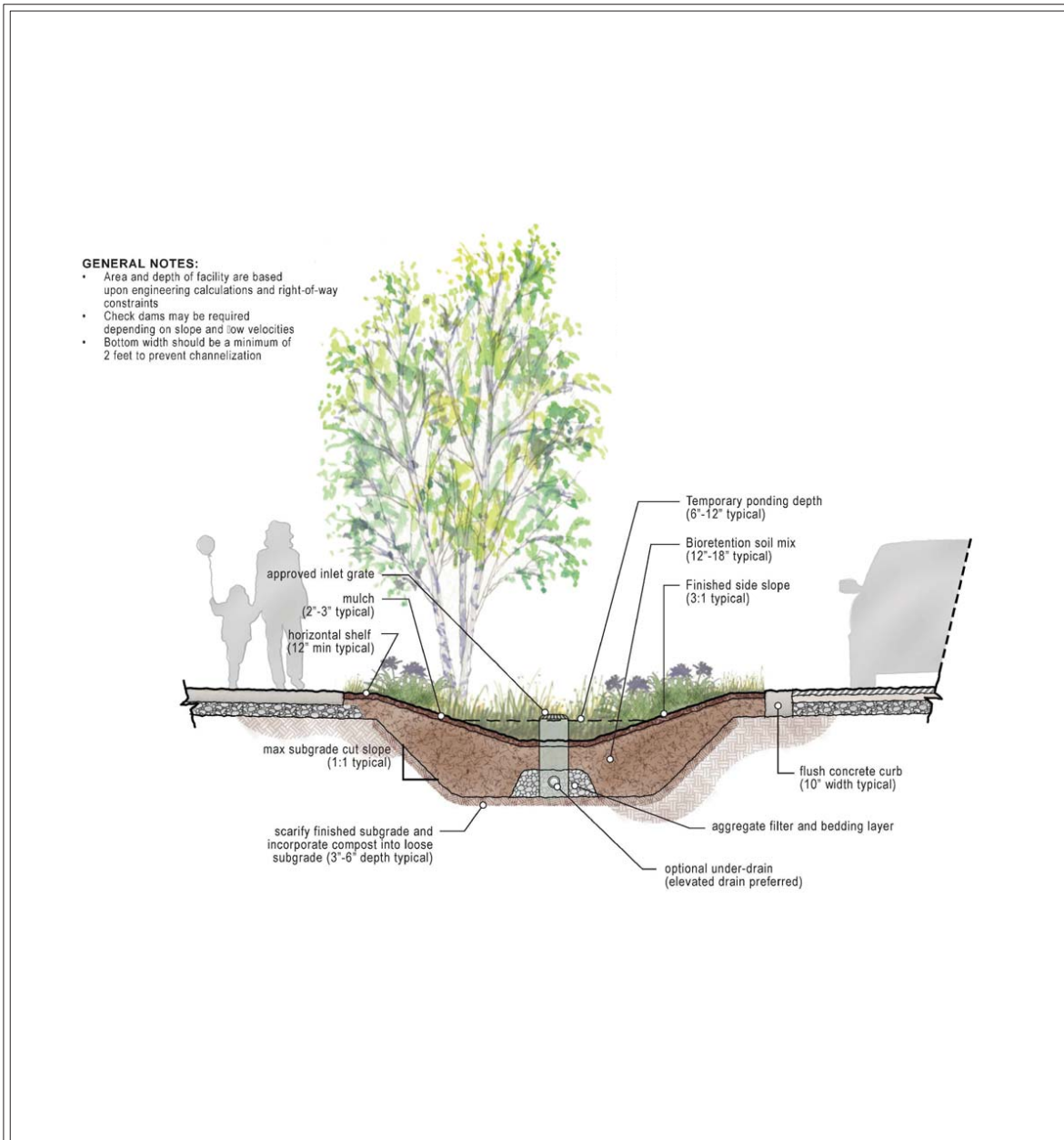
Bioretention BMPs are:

- Shallow landscaped depressions with a designed soil mix and plants adapted to the local climate and soil moisture conditions that receive stormwater runoff from small contributing areas;
- Designed to mimic natural forested conditions, where healthy soil structure and vegetation promote the infiltration, storage, filtration, and slow release of stormwater flows;
- Small-scale, dispersed, and integrated into the site as a landscape amenity; and
- Can be used as a stand-alone practice on an individual lot; however, best performance is often achieved when integrated with other BMPs.

The following types of bioretention BMPs are described in the *Stormwater Management Manual for Eastern Washington* (manual):

- **Bioretention cells:** Shallow depressions with a designed planting soil mix and a variety of plant material, including trees, shrubs, grasses, and/or other herbaceous plants. Bioretention cells may or may not have an underdrain and control structure and are not designed as a conveyance system. Side slopes are typically gentle; however, side slopes may be steep or vertical in urban areas with space limitations. Ponding depths are typically 6 to 12 inches.
- **Bioretention swales:** Incorporate the same design features as bioretention cells; however, bioretention swales are designed as part of a system that can convey stormwater when maximum ponding depth is exceeded (see [Figure 5.3: Typical Bioretention Swale](#)).
- **Infiltration planters:** Designed soil mix and a variety of plant material, including trees, shrubs, grasses, and/or other herbaceous plants within a vertical walled container usually constructed from formed concrete, but could include other materials. Infiltration planters have an open bottom that allows infiltration to the subgrade. These designs are often used in urban settings (see [Figure 5.4: Typical Bioretention Planter](#)).
- **Flow-through planters:** Designed soil mix and a variety of plant material, including trees, shrubs, grasses, and/or other herbaceous plants within a vertical walled container usually constructed from formed concrete, but could include other materials. A flow-through planter is completely impervious and includes a bottom and, accordingly, must include an underdrain and perhaps a control structure. These designs are often used in urban settings. To be considered an LID practice the flow-through planter must have a volume reduction, flow control, or treatment component to the design (see [Figure 5.4: Typical Bioretention Planter](#)).

**Figure 5.3: Typical Bioretention Swale**



Source: Low Impact Development Technical Guidance Manual for Puget Sound (WSU-PSP, 2012)



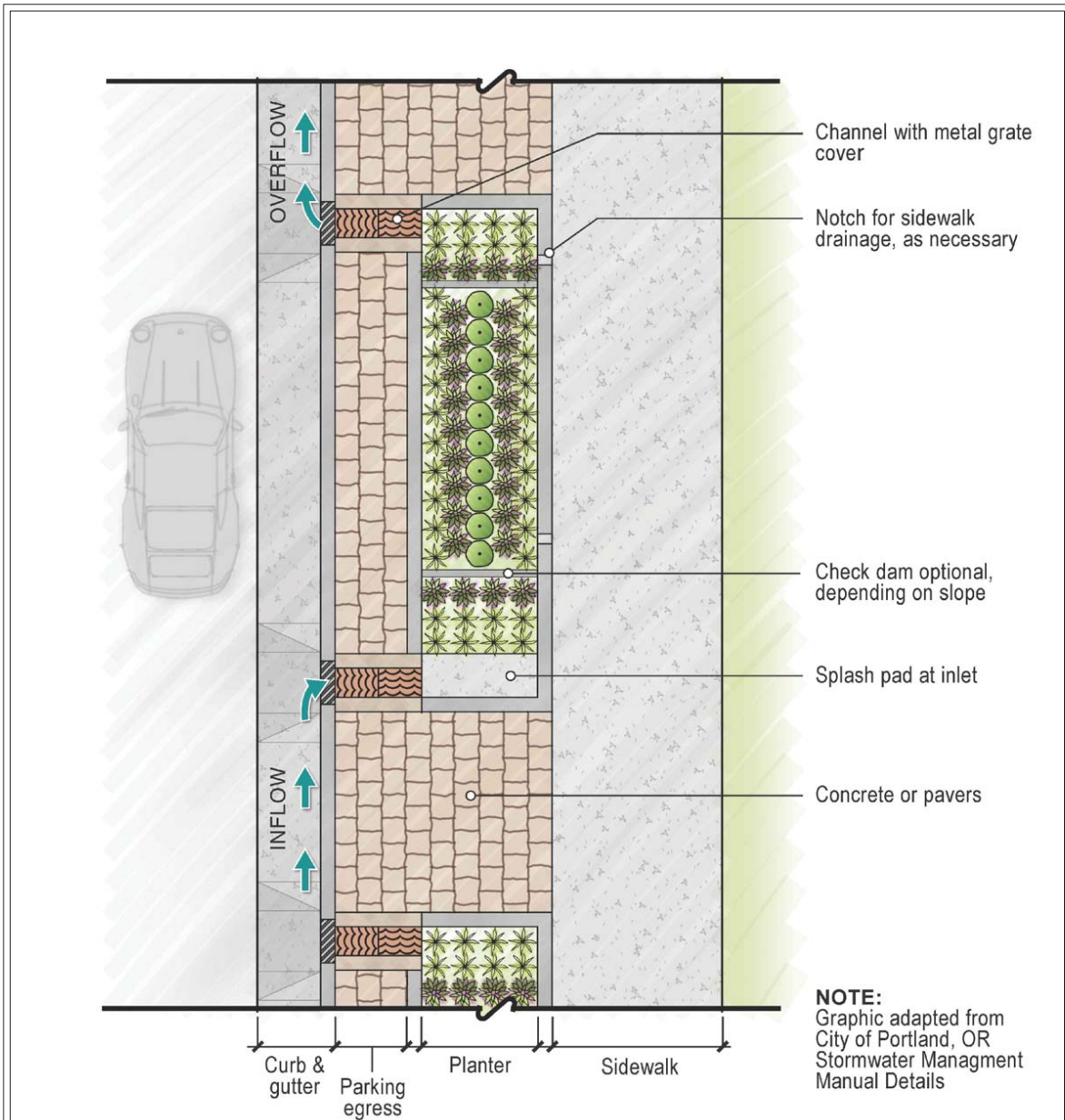
## Typical Bioretention Swale

Revised June 2013

Please see <http://www.ecy.wa.gov/copyright.html> for copyright notice including permissions, limitation of liability, and disclaimer.



**Figure 5.4: Typical Bioretention Planter**



Source: Low Impact Development Technical Guidance Manual for Puget Sound (WSU-PSP, 2012)



## Typical Bioretention Planter

Revised June 2013

Please see <http://www.ecy.wa.gov/copyright.html> for copyright notice including permissions, limitation of liability, and disclaimer.

## ***Applications and Limitations***

While many applications focus primarily on stormwater pollutant removal, bioretention can be highly effective for flow control as well. Where the surrounding native soils have adequate infiltration rates, bioretention can be used as a primary or supplemental retention system. Underdrain systems can be installed and the BMP used to filter pollutants and detain flows that exceed the infiltration capacity of the surrounding soil. However, an orifice or other control structure is necessary for designs with underdrains to provide significant flow control benefits.

Applications with or without underdrains vary extensively and can be applied in new development, redevelopment, and retrofits. Bioretention areas are most often designed as a multifunctional landscape amenity that provides runoff treatment, stormwater volume reduction, and flow attenuation. Typical applications include the following:

- Bioretention systems are applicable to many climatological and geologic situations, with some minor design changes for cold and arid climates ([U.S. EPA, 2013](#)), as discussed below in [General Criteria](#).
- In cold climates, bioretention areas can be used as a snow storage area. When used for this purpose, or if used to treat parking lot runoff, the bioretention area should be planted with salt-tolerant and nonwoody plant species.
- Protection of cold water streams, notably trout streams that are extremely sensitive to changes in temperature. Bioretention has been shown to decrease the temperature of runoff from certain land uses, such as parking lots ([U.S. EPA, 2013](#)).
- Individual lots for managing rooftop, driveway, and other on-lot impervious surface.
- Shared facilities located in common areas for multiple lots.
- Areas within loop roads or cul-de-sacs.
- Landscaped parking lot islands.
- Within rights-of-way along roads (often linear bioretention swales and cells). These BMPs are sometimes designed to have traffic-calming functions as well.
- Common landscaped areas in apartment complexes or other multifamily housing designs.
- Infiltration planters are often used in highly urban settings as stormwater management retrofits next to buildings or within streetscapes.
- Stormwater hot spots, or areas where land use or activities generate highly contaminated runoff, such as a gas station. Bioretention can be used to treat stormwater hot spots as long as an impermeable liner is used at the bottom of the treatment media layer ([U.S. EPA, 2013](#)), appropriate plants are selected that can tolerate contaminants present at the site, and inspection and maintenance plans are adequate to identify and address adaptive measures if needed.

While bioretention is one of the more widely applicable runoff treatment BMPs, there are some limitations to its use. Although bioretention does not typically consume a large amount of space, incorporating bioretention into site designs could impact other site uses, such as sidewalk or parking

spaces. In areas where infiltration is not feasible, underdrains may be needed. Bioretention BMPs with underdrains can provide significant runoff treatment benefits, but typically provide less flow control than non-underdrained BMPs. Bioretention BMPs with underdrains are not recommended to be installed if the underdrain discharge would be routed to a phosphorus-sensitive receiving water body ([Ecology, 2016](#)). Also note that underdrains could add complications with regards to conflicts with existing or future utilities.

See [5.4.4 Screening Criteria for Infiltration BMPs](#) for more discussion of limitations based on the screening criteria for infiltration BMPs.

## ***Determining Subgrade and Bioretention Soil Media Design Infiltration Rates***

Determining infiltration rates of the soils underlying the bioretention areas and the bioretention soil media (BSM) is necessary for sizing BMPs, routing, checking for compliance with the maximum drawdown time, and determining flow reduction and runoff treatment benefits.

This section describes methods for determining infiltration rates and design procedures specific to bioretention areas. For information on overall site assessment, see [3.D.2 LID Site Planning](#).

Determining the flow control ([Chapter 6 - Flow Control BMP Design](#)) and runoff treatment benefits of bioretention areas without underdrains requires knowledge of the following:

- The short-term (initial/measured) saturated hydraulic conductivity ( $K_{sat}$ ; see [6.3.3 General Criteria for Infiltration BMPs](#)) of soils underlying the bioretention area.
- If and what correction factors are applied to determine the long-term (design) infiltration rate of the soils underlying the bioretention areas (see [6.3.3 General Criteria for Infiltration BMPs](#)).
- The estimated long-term design BSM rate (short-term or initial  $K_{sat}$  with appropriate correction factor applied).

See [6.3.3 General Criteria for Infiltration BMPs](#) and [Appendix 6-B: Guidelines for Site Characterization of Geotechnical Properties](#) for discussions of native soil infiltration test methods.

Determining the flow control and runoff treatment benefits of bioretention areas with underdrains requires knowledge of the following:

- The estimated long-term BSM rate (short-term or initial  $K_{sat}$  with appropriate correction factor applied); and
- The orifice or control structure design.

### **Subgrade Soils Underlying the Bioretention Areas**

See [6.3.3 General Criteria for Infiltration BMPs](#) for details on determining infiltration rates for subgrade soils.

### **Bioretention Soil Media**

The following provides recommended tests and guidelines for determining infiltration rates of the BSM. If not using the BSM in the General Criteria, [Bioretention Soil Media](#) section below, determine

$K_{sat}$  by ASTM D2434-68, Standard Test Method for Permeability of Granular Soils (Constant Head), with a compaction rate of 85% using ASTM D1557-12, Test Method for Laboratory Compaction Characteristics of Soil Using Modified Effort. If using the BSM in the General Criteria, [Bioretention Soil Media](#) section below, assume a  $K_{sat}$  of 6 inches per hour (in/hr). Depending on the size of contributing area, use one of the following two guidelines:

- If the contributing area of the bioretention cell or swale has < 5,000 square feet (sf) of pollution-generating impervious surface (PGIS), < 10,000 sf of impervious surface, and < 0.75 acres of lawn, landscape, and other pervious surface:
  - Use 2 (multiply by 0.5) as the infiltration reduction (correction) factor.
- If the contributing area of the bioretention cell or swale is equal to or exceeds any of the following thresholds: 5,000 sf of PGIS, 10,000 sf of impervious surface, or 0.75 acres of lawn, landscape, and other pervious surface:
  - Use 4 (multiply by 0.25) as the infiltration reduction (correction) factor.

Enter the subgrade and BSM infiltration rates in a numerical model to determine the runoff treatment and/or flow control benefits of the bioretention areas. See [Design Procedure](#) for more discussion of bioretention sizing procedures.

ASTM D2434-68, Standard Test Method for Permeability of Granular Soils, provides standardized guidelines for determining hydraulic conductivity of mineral aggregate (granular) soils. BSM contains significant amounts of organic material and specific procedures within geotechnical laboratories can vary.

## **General Criteria**

With annual precipitation ranging from 7 to > 75 inches across eastern Washington, the character of bioretention BMPs will vary considerably throughout the region.

Bioretention BMPs are placed in a variety of residential and commercial settings and are a visible and accessible component of the site. Design objectives and site context are, therefore, important factors for successful application. Key design and site suitability principles for bioretention design in eastern Washington include the following:

- **Soils:** The BSM and soils underlying and surrounding bioretention BMPs are the principal design elements for determining infiltration capacity, sizing, and associated conveyance structures. The BSM placed in the cell or swale is typically composed of a highly permeable sandy mineral aggregate mixed with compost (or other locally available substitutes) and will often have a higher infiltration rate than the surrounding subgrade; however, in some cases (such as outwash soils) the subgrade infiltration rate may be higher.

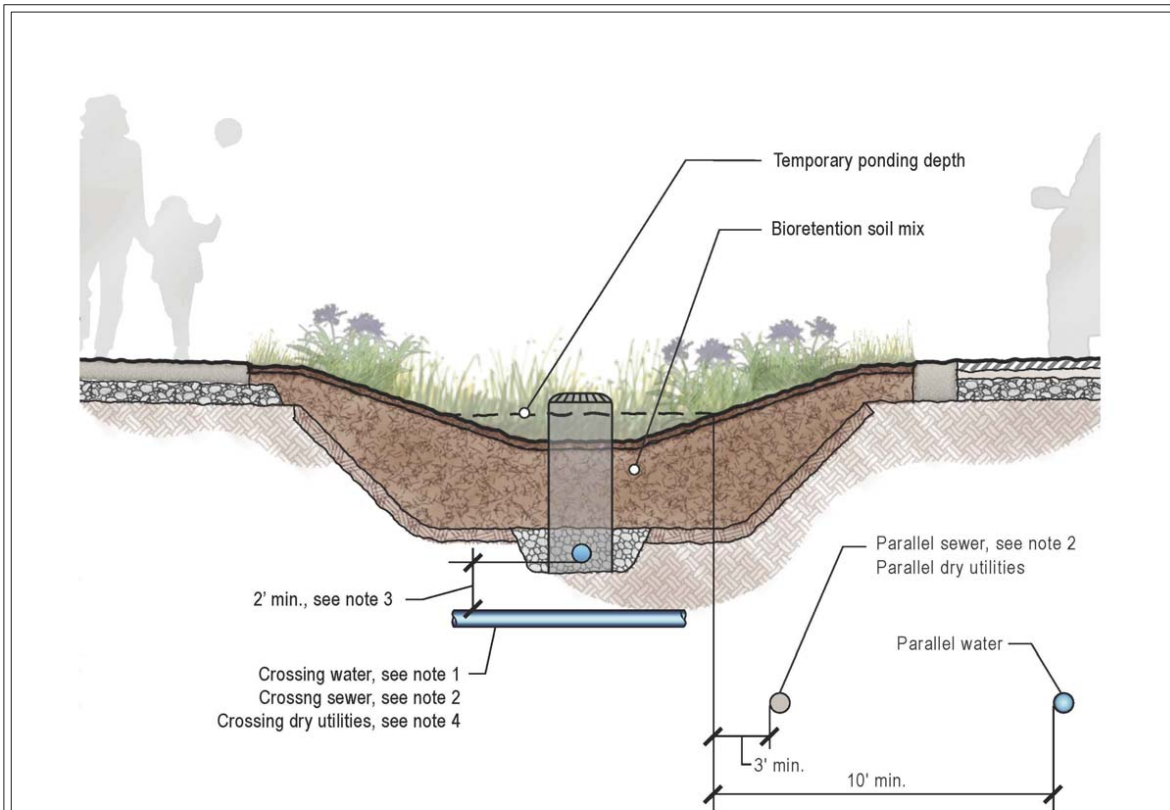
See the [Bioretention Soil Media](#) section below for details.

- **Plantings:** In arid and semiarid environments, adapted, drought-tolerant species may be better suited to bioretention BMPs than native species. Plantings may also need to withstand added stresses associated with snow plowing and snow storage, where applicable. These conditions suggest a minimum plant establishment of 2 to 3 years.
- **Site topography:** Based on geotechnical concerns, infiltration on slopes > 10% should only

be considered with caution. The site assessment should clearly define any landslide and erosion critical areas and coastal bluffs, and appropriate setbacks required by the local jurisdiction. Thorough geotechnical analysis should be included when considering infiltration within or near slope setbacks. Depending on adjacent infrastructure (e.g., basements and subsurface utilities) and subgrade geology, geotechnical analysis may also be necessary on relatively low gradients.

- **Depth to hydraulic restriction layer:** Separation to a hydraulic restriction layer (rock, compacted soil layer or water table) is an important design consideration for infiltration and flow control performance. Protecting ground water quality is a critical factor when infiltrating stormwater; however, when determining depth to the water table for bioretention BMPs, the primary concern is infiltration capacity (as influenced by ground water mounding) and associated flow control performance. When properly designed and constructed, the BSM will provide runoff treatment before infiltrated stormwater reaches the subgrade and then ground water (see the [Bioretention Soil Media](#) section below for recommended BSM depth). The following are recommended minimum separations to ground water:
  - A minimum separation of 1 foot from the hydraulic restriction layer to the bottom of the bioretention area is recommended where the contributing area has < 5,000 sf of PGIS; < 10,000 sf of impervious surface; and < 0.75 acres of lawn, landscape, and other pervious surface.
  - A minimum separation of 3 feet from the hydraulic restriction layer to the bottom of the bioretention area is recommended where the contributing area is equal to or exceeds any of the following limitations: 5,000 sf of PGIS; 10,000 sf of impervious surface; or 0.75 acres of lawn, landscape, and other pervious surface.
  - Note: Recommended separation distances for bioretention areas with small contributing areas are less than the Washington State Department of Ecology's (Ecology's) recommendation of 3 to 5 feet for conventional infiltration BMPs (see [SSC-5: Depth to Bedrock, Ground Water Table, or Impermeable Layer](#)) for two reasons: (1) BSM provides effective pollutant capture; and (2) hydrologic loading and potential for ground water mounding is reduced when flows are directed to bioretention BMPs from smaller contributing areas.
- **Utilities:** Consult local jurisdiction requirements for horizontal and vertical separations required for publicly owned utilities, such as water, sewer, and stormwater pipes. Consult the appropriate franchise utility owners for utility separation requirements, which may include communications and/or gas. See [Figure 5.5: Recommended Utility Setbacks for Bioretention](#) for an example design detail illustrating vertical and horizontal separation requirements for roadway bioretention. Extensive potholing (or excavation to daylight and document utilities) may be needed during project planning and design to develop a complete understanding of the type, location, and construction of all utilities that may be impacted by the project. When applicable separation requirements cannot be met, designs should include appropriate mitigation measures, such as impermeable liners over the utility, sleeving utilities, fixing known leaky joints or cracked conduits, and/or adding an underdrain to the bioretention areas to minimize the amount of infiltrated stormwater that could enter the utility.

**Figure 5.5: Recommended Utility Setbacks for Bioretention**



**NOTES:**

1. Line bioretention or sleeve water lines at crossing locations, if directed by engineer.
2. Line bioretention where side sewer is above the bioretention facility, or use sealed sewer pipe where sewer pipes may be vulnerable to infiltration, if directed by engineer.
3. Use polyethylene foam pad or other approved materials when utility crossing separation standards cannot be achieved per local jurisdiction standards.
4. Dry utilities, such as power, gas, and communications, may be backfilled with non-infiltrating materials, such as controlled density fill or fluidized thermal backfill. Include appropriate measures in designs to protect these utilities and account for their possible effect on infiltration performance.
5. Sufficient potholing or other investigation techniques should be conducted to determine the location and construction of all utilities in the project corridor.
6. If infiltration into utility trenches is a concern, use trench dams or other means of preventing or limiting migration of infiltrated stormwater.

Source: Low Impact Development Technical Guidance Manual for Puget Sound (WSU-PSP, 2012)



**Recommended Utility Setbacks for Bioretention**

Revised June 2013

Please see <http://www.ecy.wa.gov/copyright.html> for copyright notice including permissions, limitation of liability, and disclaimer.

- **Setbacks:** Consult local jurisdiction ordinances and guidelines for appropriate bioretention area setbacks from wellheads, on-site sewage systems, basements, foundations, utilities, slopes, contaminated areas, and property lines. General recommendations for the use of setbacks include the following:
  - Within 50 feet from the top of slopes > 20%.
  - Within 100 feet of an area known to have deep soil contamination.
  - Within 100 feet of a closed or active landfill.
  - Within 100 feet of a drinking water well, within a sanitary control area of a public drinking water well, or within 200 feet of a spring used for public drinking water supply.
  - Within 10 feet of small on-site sewage disposal drain field (including reserve area) and grey water reuse systems. For setbacks from a “large on-site sewage disposal system,” see [Chapter 246-272B WAC](#).

**Note:** Setback distances are measured from the bottom edge of the BSM (e.g., intersection of the bottom and side slope of the bioretention area).

- **Expected pollutant loading and soil and effluent quality:** Bioretention BMPs can provide very good runoff treatment. For heavy pollutant loads associated with industrial settings, an impermeable liner between the BSM and the subgrade and an underdrain may be required due to soil and ground water contamination concerns. In areas where infiltration is not recommended, a liner and underdrain should be incorporated because of soil contamination concerns, including the following:
  - For properties with known soil or ground water contamination (typically federal Superfund sites or cleanup sites under the state Model Toxics Control Act [MTCA])
  - Where ground water analysis indicates infiltration will likely increase or change the direction of the migration of pollutants in the ground water
  - Wherever surface soils have been found to be contaminated unless those soils are removed within 10 horizontal feet from the infiltration area
  - Any area where these BMPs are prohibited by an approved cleanup plan under MTCA or federal Superfund law, or an environmental covenant under [Chapter 64.70 RCW](#)
- **Phosphorus and nitrogen considerations:** For bioretention BMPs with direct discharge to fresh water or located on soils adjacent to fresh water that do not meet the SSC in [5.4.3 General Criteria for Infiltration and Bioinfiltration BMPs](#).

**For more information:** See the [Bioretention Soil Media](#) section below for recommended designs by pollutant types.

- **Transportation safety:** The design configuration and selected plant types should provide adequate sight distances, clear zones, and appropriate setbacks for roadway applications in accordance with the local jurisdiction requirements. Bioretention BMP designs that extend the curb line into the roadway (e.g., chicanes and neck-downs) can provide traffic-calming functions and improve vehicle and pedestrian safety.

- **Ponding depth and surface water drawdown:** Plant and soil health, flow control needs, runoff treatment performance, location in the development, and mosquito breeding cycles will determine drawdown timing. For example, front yards and entrances to residential or commercial developments may require more rapid surface dewatering than necessary for plant and soil health due to aesthetic needs.

**For more information:** See the [Bioretention Soil Media](#) section for details.

- **Infiltration capability:** See [5.4.3 General Criteria for Infiltration and Bioinfiltration BMPs](#) for the recommended minimum infiltration rate. If designing bioretention BMPs for flow control to meet the requirements of [2.7.7 Core Element #6: Flow Control](#), also see [6.3.2 Application](#) and [6.3.3 General Criteria for Infiltration BMPs](#).
- **Impacts of surrounding activities:** Human activity influences the location of the BMP in the development. For example, locate bioretention areas away from traveled areas on individual lots to prevent soil compaction and damage to vegetation, or provide elevated or bermed pathways in areas where foot traffic is inevitable and provide barriers, such as wheel stops, to restrict vehicle access in parking lot applications.
- **Visual buffering:** Bioretention areas can be used to buffer structures from roads, enhance privacy among residences, and for an aesthetic site feature.
- **Site growing characteristics and plant selection:** Appropriate plants should be selected for sun exposure, soil moisture, and adjacent plant communities. Native species or hardy cultivars are recommended and can flourish in the properly designed and placed BSM with no nutrient or pesticide inputs and 2 to 3 years irrigation for establishment. Manual control of invasive species may be necessary. Pesticides or herbicides should never be applied in bioretention areas.

**For more information:** See [Appendix 5-B: Planting Recommendations](#) for planting recommendations.

- **Maintenance:** See [Operation and Maintenance Criteria](#).

The following text provides general design criteria for seven bioretention components:

- Flow entrance
- Presettling
- Bottom area and side slopes
- Ponding area
- Surface overflow
- Bioretention soil media
- Underdrain (optional)

### **Flow Entrance**



Flow entrance design will depend on topography, flow velocities, and volume entering the pretreatment and bioretention area, adjacent land use, and site constraints. Flows entering a bioretention BMP should be < 1.0 foot per second (ft/sec) to minimize erosion potential. Four primary types of flow entrances can be used for bioretention cells:

- **Dispersed, low-velocity flow across a landscape area:** Landscape areas and vegetated buffer strips slow incoming flows and provide an initial settling of particulates and are the preferred method of delivering flows to the bioretention cell. Dispersed flow may not be possible given space limitations or if the BMP is controlling roadway or parking lot flows where curbs are mandatory.

Dispersed or sheet flow across pavement or gravel and past wheel stops for parking areas.

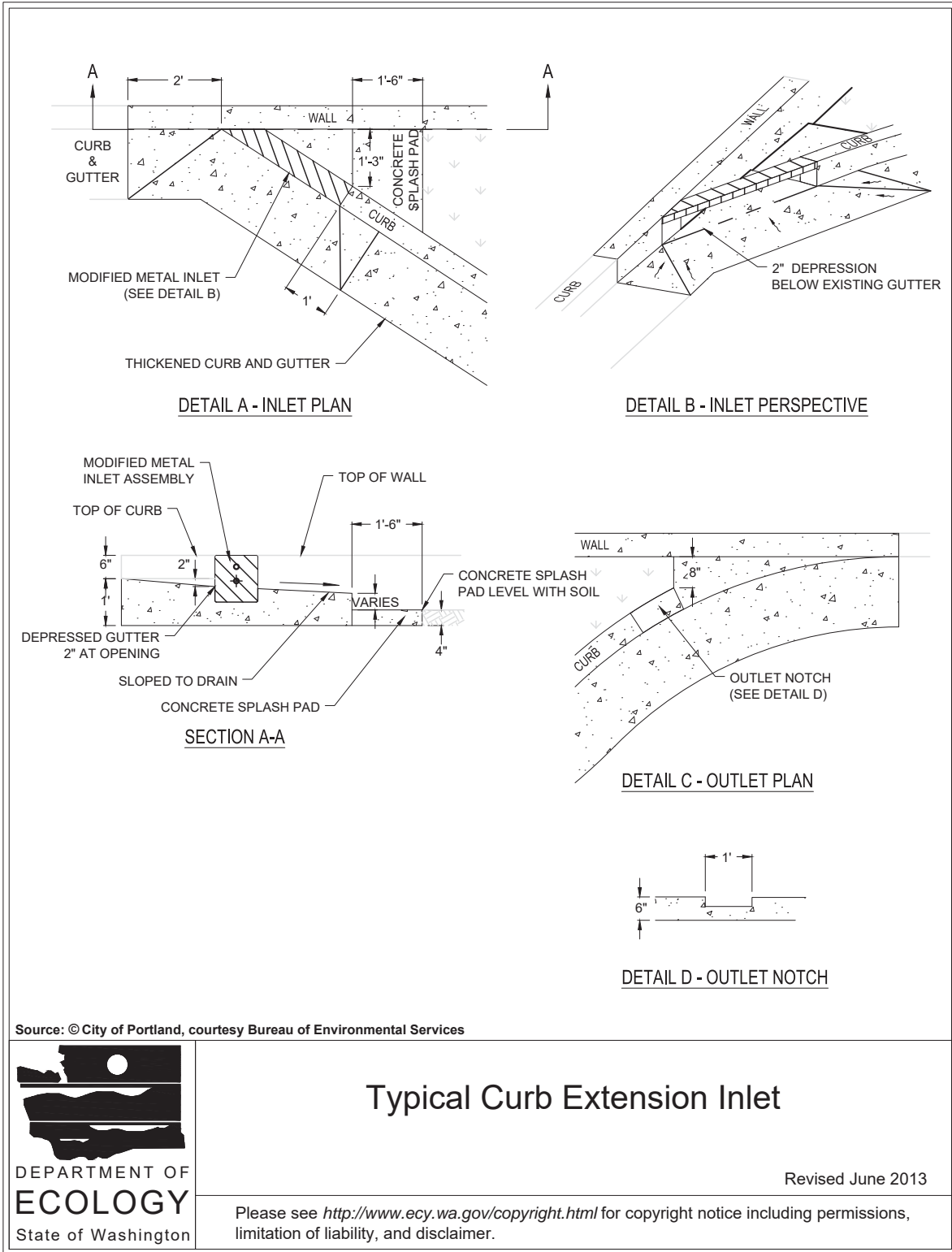
- **Curb cuts for roadside, driveway or parking lot areas:** Curb cuts should include a rock pad, concrete, or other erosion protection material in the channel entrance to dissipate energy. Minimum curb cut width should be 12 inches; however, 18 inches is recommended. Avoid the use of angular rock or quarry spalls and instead use round (river) rock if needed. Removing sediment from angular rock is difficult. The flow entrance should drop 2 to 3 inches from the curb line (see [Figure 5.6: Typical Curb Extension Inlet](#) and [Figure 5.7: Typical Concrete Curb Inlet](#)) and provide an area for settling and periodic removal of sediment and coarse material before flow dissipates to the remainder of the cell ([Prince George's County, 2007](#)); ([USACE, 2003](#)).

Curb cuts used for bioretention areas in high-use parking lots or roadways may require higher level of maintenance due to increased accumulation of coarse particulates and trash in the flow entrance and associated bypass of flows. Recommended methods for areas where heavy trash and coarse particulates are anticipated are as follows:

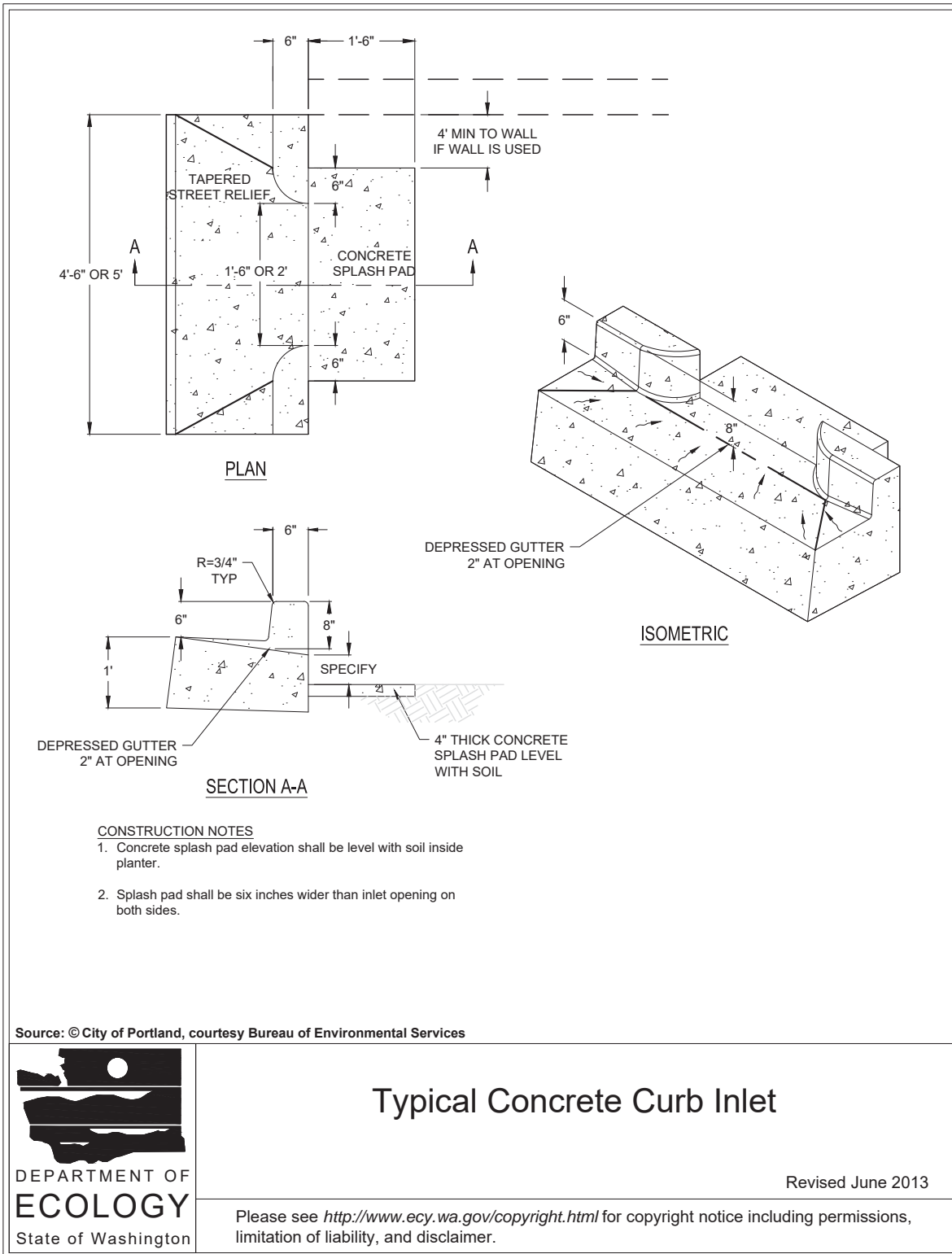
- Make curb cut width a minimum of 18 inches.
  - At a minimum the flow entrance should drop 2 to 3 inches from gutter line into the bioretention area and provide an area with a concrete bottom for settling and periodic removal of debris.
  - Anticipate relatively more frequent inspection and maintenance for areas with large impervious areas, high traffic loads, and larger debris loads.
  - Catch basins or forebays may be necessary at the flow entrance to adequately capture debris and sediment load from large contributing areas and high-use areas. Piped flow entrance in this setting can easily clog, and regular maintenance of catch basins is necessary to capture coarse and fine debris and sediment.
- **Piped flow entrance:** Piped entrances should include rock or other erosion protection material in the channel entrance to dissipate energy and disperse flow.
  - **Trench drains:** Trench drains can be used to cross sidewalks or driveways where a deeper pipe conveyance creates elevation problems. Trench drains tend to clog and may require additional maintenance (see [Figure 5.8: Typical Trench Drain Inlet](#)).

Woody plants can restrict or concentrate flows, can be damaged by erosion around the root ball, and should not be placed directly in the entrance flow path.

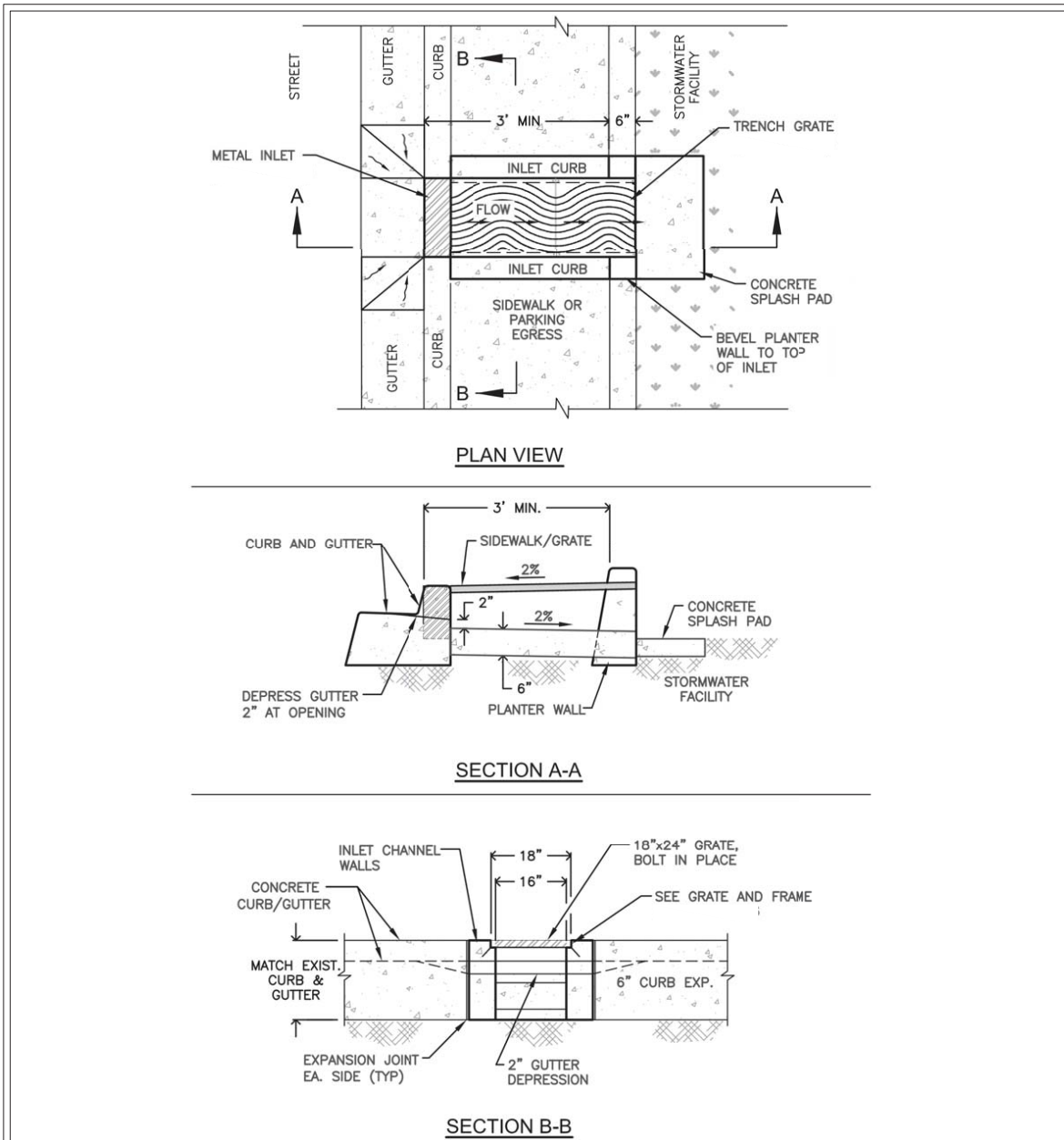
**Figure 5.6: Typical Curb Extension Inlet**



**Figure 5.7: Typical Concrete Curb Inlet**



**Figure 5.8: Typical Trench Drain Inlet**



Source: © City of Portland, courtesy Bureau of Environmental Services



## Typical Trench Drain Inlet

Revised June 2013

Please see <http://www.ecy.wa.gov/copyright.html> for copyright notice including permissions, limitation of liability, and disclaimer.

## **Presettling**

Forebays and presettling are recommended for concentrated flow entrances (curb cuts, trench drains, and pipes) to reduce accumulation of sediment and trash in the bioretention area and maintenance effort. Catch basins or open forebays can be used for presettling.

- **Catch basins:** In some locations where road sanding or higher than usual sediment inputs are anticipated, catch basins can be used to settle sediment and release water to the bioretention area through a grate for filtering coarse material.
- **Open forebays (presettling areas specifically designed to capture and hold flows that first enter the bioretention area):** The bottom of the presettling area should be large rock (2- to 4-inch streambed or round cobbles) or concrete pad with a porous berm or weir that ponds the water to a maximum depth of 12 inches.

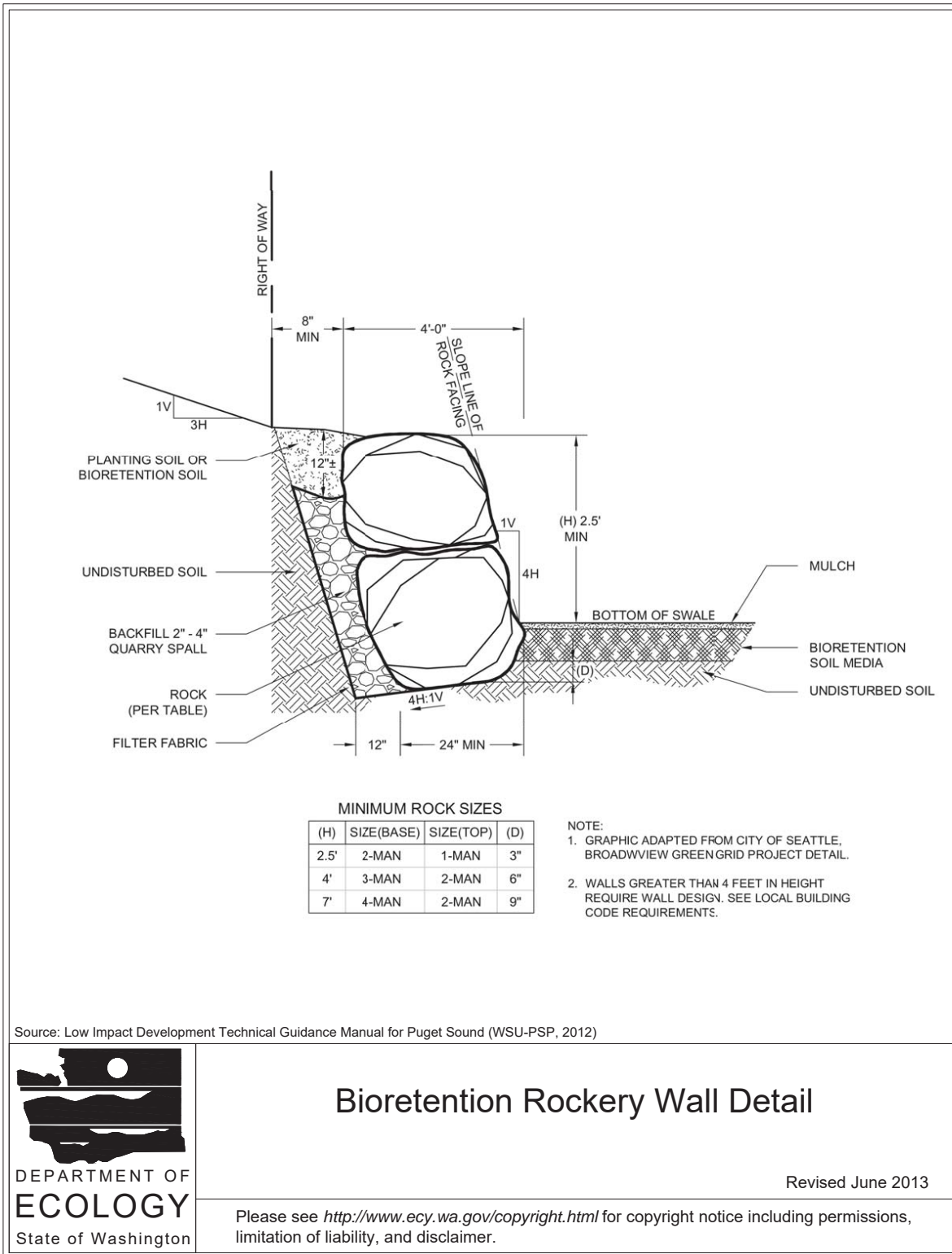
## **Bottom Area and Side Slopes**

Bioretention areas are highly adaptable and can fit various settings, such as rural and urban roadsides, ultraurban streetscapes, and parking lots by adjusting bottom area and side slope configuration. The recommended maximum and minimum dimensions are as follows:

- **Maximum planted side slope if total cell depth is > 3 feet:** 3H:1V. If steeper side slopes are necessary, rockeries, concrete walls, or soil wraps may be effective design options (see [Figure 5.9: Bioretention Rockery Wall Detail](#)). Local jurisdictions may require bike and/or pedestrian safety features, such as railings or curbs with curb cuts, when steep side slopes are adjacent to sidewalks, walkways, or bike lanes.
- **Minimum bottom width for bioretention swales:** 2 feet recommended. Carefully consider flow depths and velocities, flow velocity control (check dams), and appropriate vegetation or rock mulch to prevent erosion and channelization at bottom widths < 2 feet.

Bioretention areas should have a minimum shoulder of 12 inches between the road edge and beginning of the bioretention side slope where flush curbs are used. Compaction effort for the shoulder should be 90% standard Proctor.

**Figure 5.9: Bioretention Rockery Wall Detail**



## **Ponding Area**

The ponding depth criteria are the following:

- Maximum ponding depth: 12 inches (unless local jurisdiction provides other requirements)
- Maximum surface pool drawdown time: 72 hours

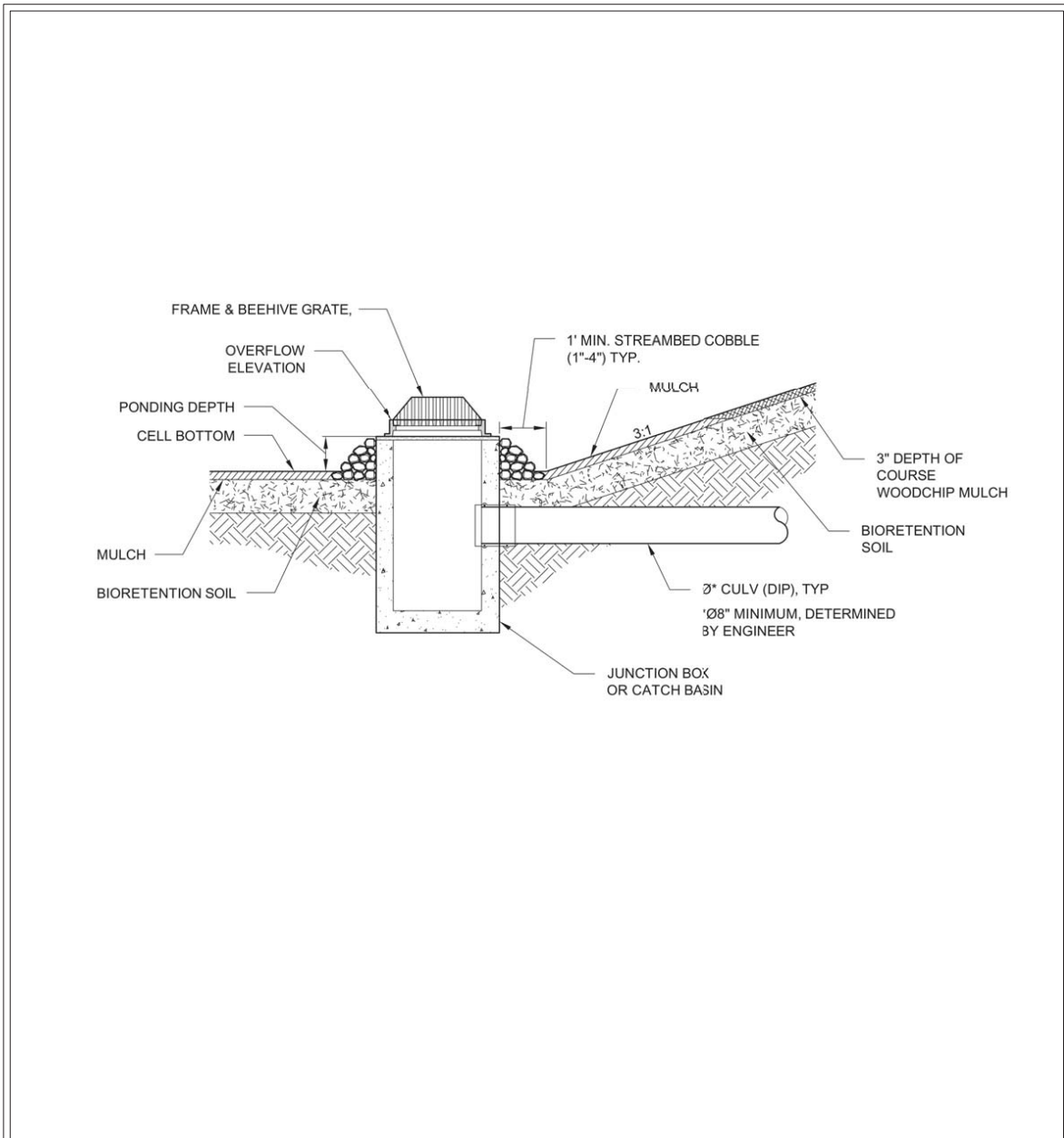
The ponding area provides surface storage for storm flows, particulate settling, and the first stages of pollutant treatment within the cell. Pool depth and drawdown rate are recommended to provide surface storage, adequate infiltration capability, and soil moisture conditions that allow for a range of appropriate plant species. Soils must be allowed to dry out periodically in order to restore hydraulic capacity to receive flows from subsequent storms, maintain infiltration rates, maintain adequate soil oxygen levels for healthy soil biota and vegetation, and provide proper soil conditions for biodegradation and retention of pollutants.

## **Surface Overflow**

Surface overflow can be provided by vertical stand pipes that are connected to underdrain systems, horizontal drainage pipes, or armored overflow channels installed at the designed maximum ponding elevations (see [Figure 5.10: Typical Bioretention Outlet Structure](#)). Overflow can also be provided by a curb cut at the downgradient end of the bioretention area to direct overflows back to the street. Overflow conveyance structures are necessary for all bioretention BMPs to safely convey flows that exceed the capacity of the BMP and to protect downstream natural resources and property.

The minimum freeboard from the invert of the overflow stand pipe, horizontal drainage pipe, or earthen channel should be 6 inches unless otherwise specified by the local jurisdiction's design standards.

**Figure 5.10: Typical Bioretention Outlet Structure**



Source: Low Impact Development Technical Guidance Manual for Puget Sound (WSU-PSP, 2012)



## Typical Bioretention Outlet Structure

Revised June 2013

Please see <http://www.ecy.wa.gov/copyright.html> for copyright notice including permissions, limitation of liability, and disclaimer.



## **Bioretention Soil Media**

The soil media and plants must work together to provide effective flow control and runoff treatment in bioretention areas. Soil mixes for bioretention areas need to balance four primary design objectives to provide optimum performance:

- Provide high enough infiltration rates to meet desired surface water drawdown and system dewatering.
- Provide infiltration rates that are not too high in order to optimize pollutant removal capability.
- Provide a growth medium that supports long-term plant and soil health.
- Balance nutrient availability and retention to reduce or eliminate nutrient export during storm events ([Hinman, 2009](#)).

Recommendations for BSM often have a topsoil component that generally does not have a grain size distribution specification and is highly variable depending on the source. As a result, the BSM can have higher than desired fines which may result in lower than desired infiltration rates.

The percentage of fines (aggregate passing the No. 200 sieve) in a BSM is important for proper system performance and requires particular attention. Presence of some fine material improves water retention, nutrient exchange and, as a result, the growing characteristics of soils. Smaller aggregate also increases receptor sites for adsorbing pollutants. In contrast, fine material strongly controls hydraulic conductivity and a small increase as a percentage of total aggregate can reduce hydraulic conductivity below rates needed for proper system drawdown ([Hinman, 2009](#)).

Overall gradation is important for BSM performance as well. Water will likely infiltrate the soil mix too rapidly if the aggregate component is a uniform particle size. Specifically, a uniformly graded, fine-grained material will have relatively low hydraulic conductivity (K). A uniformly graded, coarse-grained material will have a relatively high hydraulic conductivity. However, a well-graded material that appears coarse-grained (BSM sand) can have relatively lower hydraulic conductivity in ranges suitable for BSM used without control structures.

The following provides guidelines for Ecology-approved BSM. If the BSM is verified to meet the mineral aggregate gradation and compost guidelines below then no laboratory infiltration testing is required. If a different aggregate gradation and compost guideline is used, laboratory infiltration tests (ASTM methods given below) are recommended to verify that the BSM will meet infiltration requirements.

### **Infiltration Rates**

When using the approved BSM guidelines provided below, enter a  $K_{sat}$  of 6 in/hr with appropriate correction factor into the sizing analysis (see the [Design Procedure](#) section below).

If using a different BSM guideline, laboratory  $K_{sat}$  testing is required. The  $K_{sat}$  determination should be  $\geq 1$  in/hr after a correction factor of 2 or 4 is applied (see the above section [Determining Subgrade and Bioretention Soil Media Design Infiltration Rates](#)) and a maximum of 12 in/hr with no correction factors applied. Enter the laboratory-determined  $K_{sat}$  with appropriate correction factor into the sizing model.

## Mineral Aggregate

Percentage of fines: A range of 2% to 4% passing the No. 200 sieve is ideal and fines should not be above 5% for a proper functioning specification according to ASTM D422-63.

Aggregate gradation: The aggregate portion of the BSM should be well graded. According to ASTM D2487-11 (Classification of Soils for Engineering Purposes [Unified Soil Classification System]), well-graded sand for BSM should have the following gradation coefficients:

- Coefficient of uniformity ( $C_u = D_{60}/D_{10}$ )  $\geq 4$
- Coefficient of curve ( $C_c = (D_{30})^2/D_{60} * D_{10}$ )  $\geq 1$  and  $\leq 3$

[Table 5.14: Guideline for BSM Mineral Aggregate Gradation](#) provides a gradation guideline for the mineral aggregate component of a BSM specification in western Washington ([Hinman, 2009](#)). The sand gradation below is often provided by vendors as a well-graded utility or screened sand. With compost, this blend provides enough fines for adequate water retention, hydraulic conductivity within the recommended range, pollutant removal capability, and plant growth characteristics for meeting design guidelines and objectives. If compost is not available or desired for use on the project, other locally available materials may be used as long as the blend achieves the desired properties as described in this section. Some experimentation with locally available materials and mix specifications may be needed as demand for bioretention grows in eastern Washington and suppliers learn how best to provide mixes that meet designer specifications and provide desired benefits, such as supporting healthy plants and treating and retaining runoff on-site.

**Table 5.14: Guideline for BSM Mineral Aggregate Gradation**

Sieve Size	Percentage Passing
3/8 inch	100
No. 4	95 to 100
No. 10	75 to 90
No. 40	25 to 40
No. 100	4 to 10
No. 200	2 to 5

Where existing soils meet the aggregate gradation in [Table 5.14: Guideline for BSM Mineral Aggregate Gradation](#), those soils may be amended rather than importing mineral aggregate.

## Compost to Aggregate Ratio, Organic Matter Content, Cation Exchange Capacity

- Compost to aggregate ratio: 60-65 percent mineral aggregate, 35 – 40 percent compost by volume.
- Organic matter content: 5 – 8 percent by weight.

- Cation Exchange Capacity (CEC) must be > 5 milliequivalents/100 g dry soil. Note: Soil mixes meeting the above specifications do not have to be tested for CEC. They will readily meet the minimum CEC.

## Compost

To ensure that the BSM will support healthy plant growth and root development, contribute to biofiltration of pollutants, and not restrict infiltration when used in the proportions cited herein, the following compost standards are required.

- Meets the definition of “composted material” in [WAC 173-350-100](#) and complies with testing parameters and other standards in [WAC 173-350-220](#).
- Produced at a composting facility that is permitted by the jurisdictional health authority. Permitted compost facilities in Washington are included on a list available at <http://www.ecy.wa.gov/programs/swfa/organics/soil.html>
- The compost product must originate a minimum of 65 percent by volume from recycled plant waste comprised of “yard debris,” “crop residues,” and “bulking agents” as those terms are defined in [WAC 173-350-100](#). A maximum of 35 percent by volume of “post-consumer food waste” as defined in [WAC 173-350-100](#), but not including biosolids, may be substituted for recycled plant waste.
- Stable (low oxygen use and CO<sub>2</sub> generation) and mature (capable of supporting plant growth) by tests shown below. This is critical to plant success in a bioretention soil mixes.
- Moisture content range: no visible free water or dust produced when handling the material.
- Tested in accordance with the U.S. Composting Council “Test Method for the Examination of Compost and Composting” (TMECC), as established in the Composting Council’s “Seal of Testing Assurance” (STA) program. Most Washington compost facilities now use these tests.
- Screened to the following size gradations for Fine Compost when tested in accordance with TMECC test method 02.02-B, Sample Sieving for Aggregate Size Classification.”

Fine Compost shall meet the following gradation by dry weight:

- Minimum percent passing 2”: 100%
- Minimum percent passing 1”: 99%
- Minimum percent passing 5/8”: 90%
- Minimum percent passing 1/4”: 75%
- pH between 6.0 and 8.5 (TMECC 04.11-A). “Physical contaminants” (as defined in [WAC 173-350-100](#)) content less than 1% by weight (TMECC 03.08-A) total, not to exceed 0.25 percent film plastic by dry weight.
- Minimum organic matter content of 40% (TMECC 05.07-A “Loss on Ignition)
- Soluble salt content less than 4.0 dS/m (mmhos/cm) (TMECC 04.10-A “Electrical Conductivity, 1:5 Slurry Method, Mass Basis”)

- Maturity indicators from a cucumber bioassay (TMECC 05.05-A “Seedling Emergence and Relative Growth ) must be greater than 80%for both emergence and vigor”)
- Stability of 7 mg CO<sub>2</sub>-C/g OM/day or below (TMECC 05.08-B “Carbon Dioxide Evolution Rate”)
- Carbon to nitrogen ratio (TMECC 05.02A “ Carbon to Nitrogen Ratio” which uses 04.01 “Organic Carbon” and 04.02D “Total Nitrogen by Oxidation”) of less than 25:1. The C:N ratio may be up to 35:1 for plantings composed entirely of Puget Sound Lowland native species and up to 40:1 for coarse compost to be used as a surface mulch (not in a soil mix).

For information on using compost, compost benefits, a list of soil laboratories, and more, visit the following websites:

- Soils for Salmon at <http://www.soilsforsalmon.org/> ;
- Building Soil – the Foundation for Success at <http://www.buildingsoil.org/> ; and
- Washington Stormwater Center at <http://www.wastormwatercenter.org/low-impact/>.

### **Design Criteria for Custom Bioretention Soil Mixes**

Projects which prefer to create a custom Bioretention Soil Mix rather than using the default requirements above must demonstrate compliance with all of the following criteria using the specified test method:

- CEC ≥ 5 meq/100 grams of dry soil; USEPA 9081 I pH between 5.5 and 7.0
- 5 - 8 percent organic matter content before and after the saturated hydraulic conductivity test; ASTM D2974 (Standard Test Method for Moisture, Ash, and Organic Matter of Peat and Other Organic Soils)
- 2-5 percent fines passing the 200 sieve; TMECC 04.11-A
- Measured (Initial) saturated hydraulic conductivity of less than 12 inches per hour; ASTM D 2434 (Standard Test Method for Permeability of Granular Soils (Constant Head)) at 85% compaction per ASTM D 1557 (Standard Test Methods for Laboratory Compaction Characteristics of Soil Using Modified Effort).

See the additional guidance below for specific procedures for conducting ASTM D 2434.

- Design (long-term) saturated hydraulic conductivity of more than 1 inch per hour. Note: Design saturated hydraulic conductivity is determined by applying the appropriate infiltration correction factors as explained above under “Determining Bioretention soil mix infiltration rate.”

### **Recommended Modifications to ASTM D 2434 When Measuring Hydraulic Conductivity for Bioretention Soil Mixes**

Proctor method ASTM D1557 Method C (6-inch mold) shall be used to determine maximum dry density values for compaction of the bioretention soil sample. Sample preparation for the Proctor test shall be amended in the following ways:

1. Maximum grain size within the sample shall be no more than ½ inches in size.
2. Snip larger organic particles (if present) into 1/2 inch long pieces.
3. When adding water to the sample during the Proctor test, allow the sample to pre-soak for at least 48 hours to allow the organics to fully saturate before compacting the sample. This pre-soak ensures the organics have been fully saturated at the time of the test.

ASTM D2434 shall be used and amended in the following ways:

1. Apparatus:
  - a. 6-inch mold size shall be used for the test.
  - b. If using porous stone disks for the testing, the permeability of the stone disk shall be measured before and after the soil tests to ensure clogging or decreased permeability has not occurred during testing.
  - c. Use the confined testing method, with 5- to 10-pound force spring.
  - d. Use de-aired water.
2. Sample:
  - a. Maximum grain size within the sample shall not be more than ½ inch in size.
  - b. Snip larger organic particles (if present) into ½-inch long pieces.
  - c. Pre-soak the sample for at least 48 hours prior to loading it into the mold. During the pre-soak, the moisture content shall be higher than optimum moisture but less than full saturation (i.e., there shall be no free water). This pre-soak ensures the organics have been fully saturated at the time of the test.
3. Preparation of Sample:
  - a. Place soil in cylinder via a scoop.
  - b. Place soil in 1-inch lifts and compact using a 2-inch-diameter round tamper. Pre-weigh how much soil is necessary to fill 1-inch lift at 85% of maximum dry density, then tamp to 1-inch thickness. Once mold is full, verify that density is at 85% of maximum dry density (+ or – 0.5%). Apply vacuum (20 inches Hg) for 15 minutes before inundation.
  - c. Inundate sample slowly under a vacuum of 20 inches Hg over a period of 60 to 75 minutes.
  - d. Slowly remove vacuum (> 15 seconds).
  - e. Sample shall be soaked in the mold for 24 to 72 hours before starting test.
4. Procedure:
  - a. The permeability test shall be conducted over a range of hydraulic gradients between 0.1 and 2.

- b. Steady state flow rates shall be documented for four consecutive measurements before increasing the head.
- c. The permeability test shall be completed within one day (one-day test duration).

### **Cation Exchange Capacity**

See the cation exchange capacity (CEC) criteria in for [SSC-6: Soil Physical and Chemical Suitability for Treatment](#).

### **BSM Depth**

- BSM depth must be a minimum of 18 inches to provide water quality treatment (TSS and metals) and good growing conditions for selected plants.
- Ecology does not recommend bioretention soil mix depths greater than 18 inches due to preliminary monitoring results indicating that phosphorus can leach from the bioretention soil mix.

Deeper or shallower profiles may be desirable for specific plant, soil, and storm flow management objectives.

### **Filter Fabrics**

Do not use filter fabrics between the subgrade and the Bioretention Soil Mix. The gradation between existing soils and Bioretention Soil Mix is not great enough to allow significant migration of fines into the Bioretention Soil Mix. Additionally, filter fabrics may clog with downward migration of fines from the Bioretention Soil Mix.

### **Infiltration Rates and Runoff Treatment Considerations**

BSM provide the necessary characteristics for infiltration BMPs intended to serve a treatment function. To meet Ecology's current criteria for infiltration treatment, the BSM should meet the criteria in [SSC-6: Soil Physical and Chemical Suitability for Treatment](#).

BSM have a high content of organic matter and CECs exceeding the above CEC criteria. Additionally, recent runoff treatment research for bioretention soils suggests that capture of metals remains very good at higher infiltration rates. Nitrate and orthophosphate retention and removal is likely influenced by plants, organic matter, and soil structure as well as soil oxygen levels, soil water content, and hydraulic residence time. Infiltration rate is, therefore, one of several factors that likely play an important role for nitrate and phosphate management in bioretention systems. More research is needed examining the influence of these various factors and to develop defensible infiltration rate guidelines for nutrient management. For nutrient management guidelines resulting from current research, see the following section, Phosphorus Management Recommendations.

### **Phosphorus Management Recommendations**

These recommendations are applicable to any bioretention installation but are critical for bioretention areas that have underdrains and directly release to fresh water or eventually drain to water bodies with TDMLs for nutrients or are specifically designated as phosphorus sensitive by the local jurisdiction. Levels of phosphorus in bioretention areas are generally not a concern for ground water unless there is ground water transport of phosphorus through soils with low phosphorus sorption capability and close proximity to surface fresh water. Note that additional research is needed on phosphorus management in bioretention; however, current research indicates the

following:

- Mature stable compost reduces the leaching of bioavailable phosphorus.
- A healthy plant community provides direct phosphorus uptake, but more importantly promotes the establishment of healthy soil microbial community likely capable of rapid phosphorus uptake.
- Aerobic conditions reduce the reversal of phosphorus sorption and precipitation reactions.
- Increasing BSM column depth to 24 or 36 inches may provide greater contact time with aluminum, iron, and calcium components and greater sorption in the soil.
- BSM has a relatively neutral pH.
- Iron, aluminum, and calcium are metals that can be added to adsorb or precipitate phosphorus. Aluminum is the most applicable for bioretention systems with appropriate adsorption reaction time, relative stability, and pH range for reaction ([Lucas and Greenway, 2009](#)). Water treatment residuals (WTRs), used for settling suspended material in drinking water intakes, are waste products and sources of aluminum and iron hydroxides. More research is needed in this area, but current trials indicate that WTRs can be added at a rate of 10% by volume to the BSM for sorption of phosphorus. WTRs are fine textured and, if incorporated into the BSM, laboratory analysis is required to verify appropriate hydraulic conductivity (see [Determining Subgrade and Bioretention Soil Media Design Infiltration Rates](#)). If using WTRs at a rate of 10% by volume, add shredded bark at 15% by volume to compensate for the fine texture of the WTRs (e.g., 60% sand, 15% compost, 15% shredded bark, and 10% WTRs).
- The molar ratio of ammonia-oxalate-extracted phosphorus in relation to the ammonia-oxalate-extracted iron and aluminum in the BSM should be  $< 0.25$ .
- A sandy gravel filter bed for the underdrain provides a good filter for fine particulates and additional binding sites for phosphorus (see [Underdrain \(Optional\)](#) section).

### **Nitrogen Management Recommendations**

Nitrogen levels in bioretention areas are generally not a concern with ground water unless there is ground water transport of nitrogen in close proximity to a drinking water aquifer. Note that additional research is needed on nitrogen management in bioretention; however, current research indicates the following:

- Mature stable compost reduces leaching of bioavailable nitrate nitrogen.
- A healthy plant community provides direct uptake of nitrate nitrogen but more importantly promotes the establishment of healthy soil microbial community likely capable of rapid uptake of nitrate nitrogen.
- Increasing BSM column depth to 24 or 36 inches may provide greater contact time with small anoxic pockets within the soil structure and denitrification in the soil column.
- Research suggests that nitrogen capture and retention in bioretention areas varies from good retention to export of nitrate. Where nitrate is a concern, elevated underdrain designs can be

used to create a fluctuating anoxic/aerobic zone below the drain pipe. Denitrification within the anaerobic zone is facilitated by microbes using forms of nitrogen (nitrite and nitrate) instead of oxygen for respiration. A suitable carbon source provides a nutrition source for the microbes, enables anaerobic respiration, and can enhance the denitrification process ([Kim et al., 2003](#)). Dissolved and particulate organic carbon that migrates from the BSM to the aggregate filter and bedding layer likely provides adequate carbon source for microbes.

Biosolids and manure composts can be higher in bioavailable phosphorus and nitrogen than compost derived from yard or plant waste. Accordingly, the use of biosolids or manure compost in bioretention areas is not recommended in order to reduce the possibility of exporting bioavailable phosphorus and nitrogen in effluent.

### **Underdrain (Optional)**

Underdrain systems should typically be installed only when the bioretention area is:

- Located near sensitive infrastructure (e.g., unsealed basements) and potential for flooding is likely;
- Used for filtering storm flows from gas stations or other pollutant hotspots (requires impermeable liner);
- Located in an area with contaminated ground water and/or contaminated soils;
- Located in soils with infiltration rates below the minimum rate allowed by the local jurisdiction or that are not adequate to meet maximum pool and soil column drawdown time;
- Located in an area that does not provide the minimum depth to a hydraulic restriction layer;
- Located in an area where the underdrain discharge would not be routed to a phosphorus-sensitive water body ([Ecology, 2013](#)); and
- Located where longitudinal slopes are < 2%.

The underdrain can be connected to a downstream open conveyance (such as a bioretention swale), to another bioretention cell as part of a connected treatment system, day-lighted to a dispersion area using an effective flow dispersion practice, or to a storm drain.

### **Underdrain Pipe**

Underdrains should be slotted, thick-walled plastic pipe. The slot opening should be smaller than the smallest aggregate gradation for the gravel filter bed (see [Underdrain Aggregate Filter and Bedding Layer](#)) to prevent migration of material into the drain and clogging. This configuration also allows for pressurized water cleaning and root cutting if necessary. The following are recommendations for underdrain pipes:

- The minimum pipe diameter should be 4 inches (pipe diameter will depend on hydraulic capacity required; 4 to 8 inches is common).
- It should be slotted subsurface drain made of polyvinyl chloride (PVC) per ASTM D1785-12 SCH 40:



- Slots should be cut perpendicular to the long axis of the pipe, measure 0.04 to 0.069 inches by 1 inch, and be spaced 0.25 inches apart (spaced longitudinally). Slots should be arranged in two rows spaced on 45-degree centers and cover one-half the circumference of the pipe.
- Slots can be oriented on the top or the bottom of the pipe.
- Underdrains should be sloped at a minimum of 0.5% unless otherwise specified by a licensed professional. Perforated PVC or flexible slotted high-density polyethylene (HDPE) pipe cannot be cleaned with pressurized water or root cutting equipment, are less durable, and are not recommended.
- Wrapping the underdrain pipe in geotextile increases chances of clogging and is not recommended ([Low Impact Development Center, 2012](#)).
- A 6-inch-diameter rigid unperforated observation pipe or other maintenance access should be connected to the underdrain every 250 to 300 feet to provide a clean-out port as well as an observation well to monitor dewatering rates ([Prince George's County, 2007](#)).

### **Underdrain Aggregate Filter and Bedding Layer**

Aggregate filter and bedding layers and geotextiles buffer the underdrain system from sediment input and clogging. When properly selected for the soil gradation, geotextiles can provide adequate protection from the migration of fines. However, aggregate filter and bedding layers, with proper gradations, provide a larger filter surface area for protecting underdrains and are preferred if available locally (see [Table 5.15: Underdrain Aggregate Filter and Bedding Layer Gradation](#)).

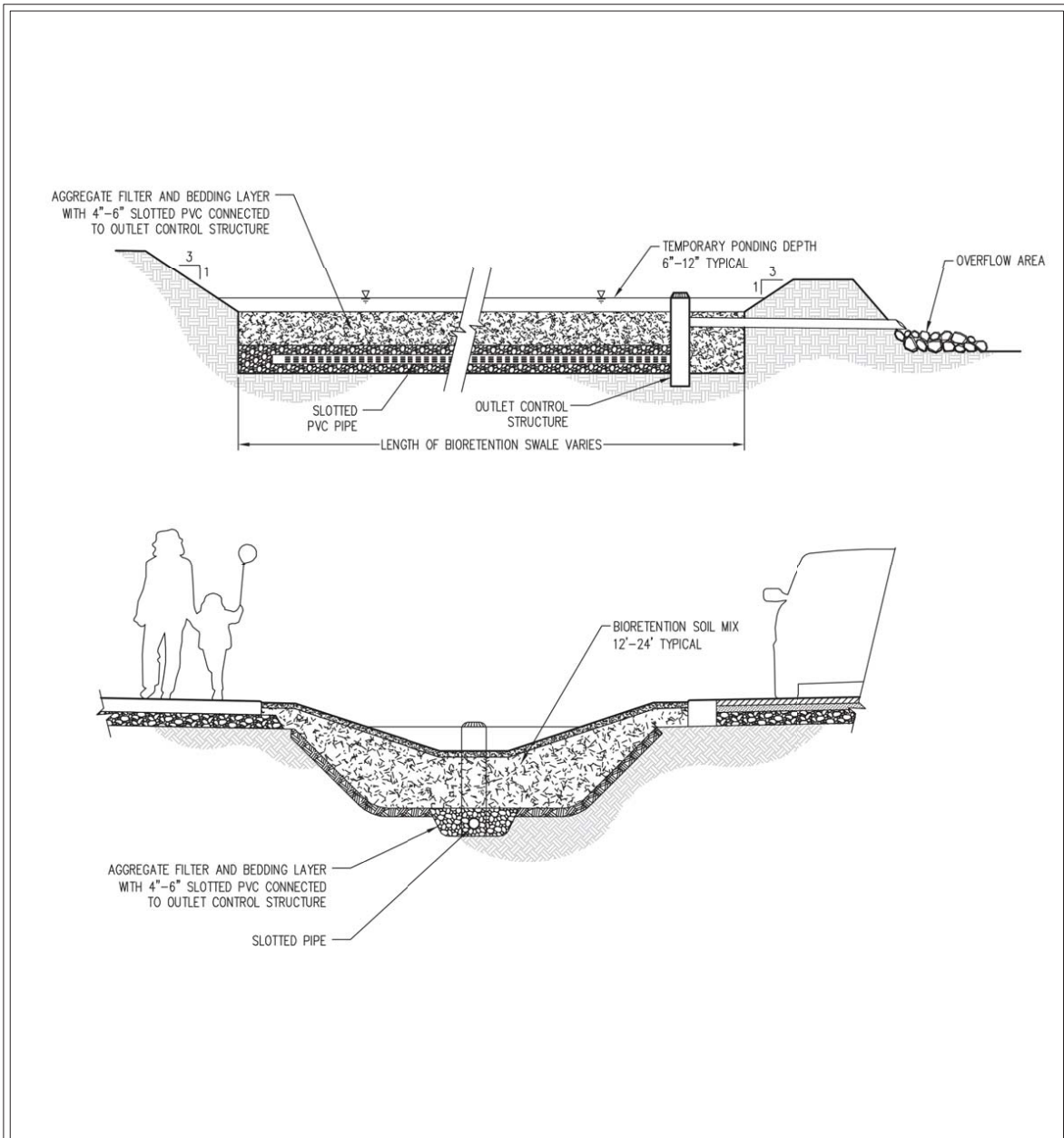
**Table 5.15: Underdrain Aggregate Filter and Bedding Layer Gradation**

Sieve Size	Percentage Passing
¾ inch	100
¼ inch	30 to 60
No. 8	20 to 50
No. 50	3 to 12
No. 200	0 to 1

### **Drain Position**

For bioretention areas with underdrains (see [Figure 5.11: Typical Upturned Bioretention Underdrain](#)), elevating the drain to create a temporary saturated zone beneath the drain promotes denitrification (conversion of nitrate to nitrogen gas) and prolongs moist soil conditions for plant survival during dry periods.

**Figure 5.11: Typical Uprturned Bioretention Underdrain**



Source: Low Impact Development Technical Guidance Manual for Puget Sound (WSU-PSP, 2012)



## Typical Uprturned Bioretention Underdrain

Revised June 2013

Please see <http://www.ecy.wa.gov/copyright.html> for copyright notice including permissions, limitation of liability, and disclaimer.

Underdrains rapidly convey water out of the bioretention area and decrease detention time and flow retention. Properly designed and installed bioretention have shown very good flow control performance on soils with low infiltration rates ([Hinman, 2009](#)). Accordingly, when underdrains are used, orifices or other control structures are recommended to improve flow control. Access for adding or adjusting orifice configurations and other control structures is also recommended for adaptive management and optimum performance.

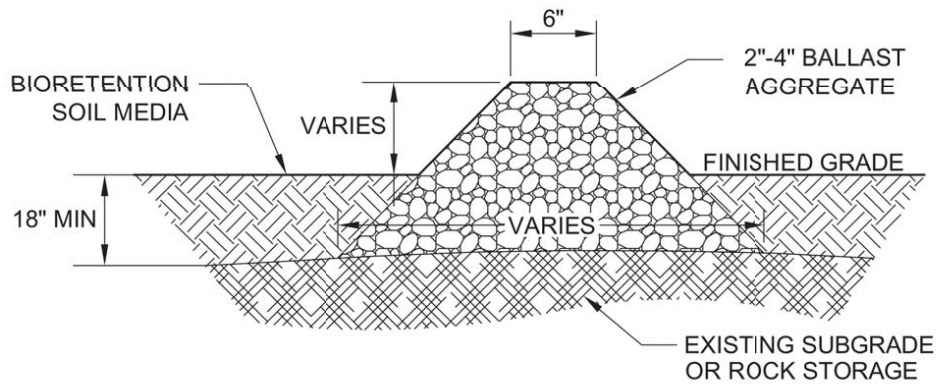
### **Orifice and Other Flow Control Structures**

The minimum orifice diameter is an important consideration in cold climates, where ice formation could restrict flows if the underdrains are not maintained during freezing periods. Consult the local jurisdiction standards for minimum orifice diameters to be used in design and consider long-term maintenance when selecting any type of flow control structure.

### **Check Dams and Weirs**

Check dams may be necessary for reducing flow velocity and potential erosion as well as increasing detention time and infiltration capability on sloped sites. Typical materials include concrete, wood, rock, compacted dense soil covered with vegetation, and vegetated hedge rows. Design depends on flow control goals, local regulations for structures within road rights-of-way, and aesthetics. Optimum spacing is determined by flow control benefit (through modeling) in relation to cost considerations. Some typical check dam designs are included in [Figure 5.12: Typical Bioretention Check Dam](#).

**Figure 5.12: Typical Bioretention Check Dam**



Source: Low Impact Development Technical Guidance Manual for Puget Sound (WSU-PSP, 2012)



## Typical Bioretention Check Dam

Revised June 2013

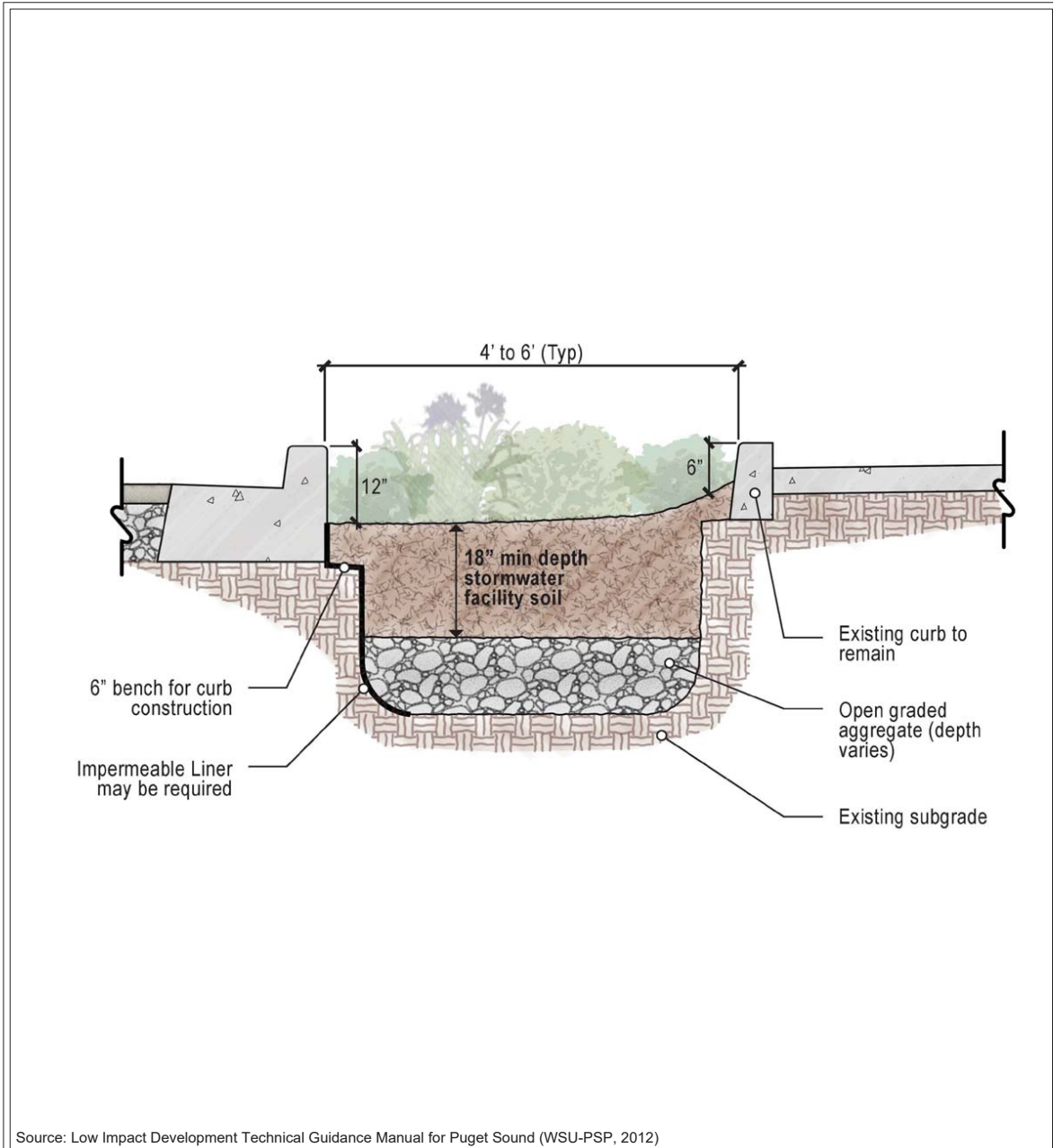
Please see <http://www.ecy.wa.gov/copyright.html> for copyright notice including permissions, limitation of liability, and disclaimer.

## **Hydraulic Restriction Layers**

Adjacent roads, foundations or other infrastructure may require that infiltration pathways are restricted to prevent excessive hydrologic loading. Two types of restricting layers can be incorporated into bioretention designs:

- Clay (bentonite) liners are low-permeability liners. Where clay liners are used, underdrain systems are necessary.
- Geomembrane liners completely block infiltration to subgrade soils and are used for ground water protection when bioretention BMPs are installed to filter storm flows from pollutant hotspots or on sidewalls of bioretention areas to restrict lateral flows to roadbeds or other sensitive infrastructure (see [Figure 5.13: Typical Bioretention Planter Section With Liner](#)). Where geomembrane liners are used to line the entire BMP, underdrain systems are necessary. The liner should have a minimum thickness of 30 mils and be resistant to ultraviolet (UV) light.

**Figure 5.13: Typical Bioretention Planter Section With Liner**



## Typical Bioretention Planter Section With Liner

Revised June 2016

Please see <http://www.ecy.wa.gov/copyright.html> for copyright notice including permissions, limitation of liability, and disclaimer.

## **Plants**

Plant roots aid in the physical and chemical bonding of soil particles that is necessary to form stable aggregates, improve soil structure, and increase infiltration capacity. In arid environments, plants can provide significant transpiration of stormwater runoff during the summer growing season. In cold climates, plants can help maintain infiltration through the bioretention section by developing macropores in the soil around roots.

**For more information:** See [Appendix 5-B: Planting Recommendations](#) for a list of recommended plants for bioretention.

The primary design considerations for plant selection are as follows:

- **Arid climates:** Plants should tolerate sustained drought ([U.S. EPA, 2013](#)).
- **Cold climates:** In cold climates, bioretention can be used for snow storage. If used for this purpose, or if used to treat runoff from a surface where salt is used as a deicing chemical, the bioretention area should be planted with salt-tolerant, nonwoody plant species ([U.S. EPA, 2013](#)). Other cold climate considerations include rooting depth and season of growth.
- **Soil moisture conditions:** Plants should be tolerant of summer drought, ponding fluctuations, and saturated soil conditions for the lengths of time anticipated by the BMP design.
- **Sun exposure:** Existing sun exposure and anticipated exposure when bioretention plants mature is a primary plant selection consideration.
- **Aboveground and belowground infrastructure in and near the BMP:** Plant size and wind firmness should be considered within the context of the surrounding infrastructure. Rooting depths should be selected to not damage underground utilities if present. Slotted or perforated pipe should be > 5 feet from tree locations (if space allows).
- **Expected pollutant loadings:** Plants should tolerate typical pollutants and loadings from the surrounding land uses.
- **Adjacent plant communities and potential invasive species control:** Consider planting hearty, fast growing species when adjacent to invasive species and anticipate maintenance needs to prevent loss of plants to encroachment of invasive species.
- **Habitat:** Native plants and hardy cultivars attract various insects and birds, and plant palettes can be selected to encourage specific species.
- **Site distances and setbacks for safety on roadway applications:** Provide site distances and setbacks for safety on roadway per local jurisdiction requirements.
- **Location of infrastructure:** Select plants and planting plan to allow visual inspection and easy location of BMP infrastructure (e.g., inlets, overflow structures and other utilities).
- **Expected use:** In higher density settings where foot traffic across bioretention areas is anticipated, elevated pathways with appropriate vegetation or other pervious material that can tolerate pedestrian use can be used. Pipes through elevated berms for pathways across bioretention areas can be used to allow flows from one cell to another.

- **Visual buffering:** Plants can be used to buffer structures from roads, enhance privacy among residences, and provide an aesthetic amenity for the site.
- **Aesthetics:** Visually pleasing plant designs add value to the property and encourage community and homeowner acceptance. Homeowner education and participation in plant selection and design for residential projects should be encouraged to promote greater involvement in long-term care.

Note that the BSM provides an excellent growth medium, and plants will often attain or surpass maximum growth dimensions. Accordingly, planting layouts should consider maximum dimensions for selected plants when assessing site distances and adjacent uses.

In general, the predominant plant materials used in bioretention areas are facultative species adapted to stresses associated with wet and dry conditions ([Prince George's County, 2007](#)). Soil moisture conditions will vary within the BMP from saturated (bottom of cell) to relatively dry (rim of cell). Accordingly, wetland plants may be used in the lower areas, if saturated soil conditions exist for appropriate periods, and drought-tolerant species planted on the perimeter of the BMP or on mounded areas.

**For more information:** See [Appendix 5-B: Planting Recommendations](#) for recommended plant species.

Planting schemes will vary with the surrounding landscape and design objectives. For example, plant themes can reflect surrounding wooded or prairie areas. Monoculture planting designs are not recommended. As a general guideline, a minimum of three small trees, three shrubs, and three herbaceous ground cover species should be incorporated to protect against BMP failure due to disease and insect infestations of a single species ([Prince George's County, 2007](#)). See local jurisdiction requirements for plant spacing, if applicable.

Native and hardy cultivar plant species, placed appropriately, tolerate local climate and biological stresses and usually require no nutrient or pesticide application in properly designed soil mixes. Natives can be used as the exclusive material in bioretention or in combination with hardy cultivars that are not invasive and do not require chemical inputs. In native landscapes, plants are often found in associations that grow together well, given specific moisture, sun, soil, and plant chemical interactions. Native plant associations can, in part, help guide planting placement. To increase survival rates and ensure the quality of plant material, the following guidelines are suggested:

- Plants should conform to the standards of the latest version of *American Standard for Nursery Stock* as approved by the American Standards Institute, Inc. All plant grades should be those established in the latest version of *American Standards for Nursery Stock*.
- All plant materials shall have normal, well-developed branches and a vigorous root system. Plants should be healthy and free from physical defects, plant diseases, and insect pests. Shade and flowering trees should be symmetrically balanced. Major branches should not have V-shaped crotches capable of causing structural weakness. Trunks should be free of unhealed branch removal wounds > 1-inch diameter ([Low Impact Development Center, 2012](#)).
- **Plant size:** For installation, small plant material provides several advantages and is recommended. Specifically, small plant material requires less careful handling, less initial



irrigation, experiences less transplant shock, is less expensive, adapts more quickly to a site, and transplants more successfully than larger material ([Sound Native Plants, 2000](#)). Typically, small herbaceous material and grasses are supplied as plugs or 4-inch pots, and small trees and shrubs are generally supplied in pots of 3 gallons or less.

- **Plant maturity and placement:** Bioretention areas provide excellent soil and growing conditions; accordingly, plants will likely reach maximum height and width. Planting plans should anticipate these dimensions for site distances, adjacent infrastructure, and planting densities. Shrubs should be located taking into account size at maturity to prevent excessive shading and ensure establishment and vigor of bioretention area bottom plants.
- All plants should be tagged for identification when delivered.
- Optimum planting time is during April or May; although fall planting between September 15 and October 31 is acceptable.

### **Mulch Layer**

Bioretention areas can be designed with or without a mulch layer; however, there are advantages to providing a mulch application. Properly selected mulch material reduces weed establishment (particularly during plant establishment period), regulates soil temperatures and moisture, and adds organic matter to soil. When used, mulch should be:

- Arborist wood chips consisting of shredded or chipped hardwood or softwood trimmings from trees and shrubs or material from wood chip operations, which provide good control of size distribution and consistency;
- Free of weed seeds, soil, roots, and other material that is not bole or branch wood and bark;
- Coarse compost in the bottom of the BMP and up to the ponding elevation (compost is less likely to float when the cell is inundated);
- Arborist wood chips on side slopes above ponding elevation and rim area;
- Free of shredded wood debris to which wood preservatives have been added; and
- A maximum of 2 to 3 inches thick to prevent the inhibition of proper oxygen and carbon dioxide cycling between the soil and atmosphere ([Prince George's County, 2007](#)).

Mulch should not be:

- Grass clippings (decomposing grass clippings are a source of N and are not recommended for mulch in bioretention areas); or
- Pure bark (bark is essentially sterile and inhibits plant establishment).

If planting bioretention areas is delayed (e.g., BSM is placed in summer and plants are not installed until fall), mulch should be placed immediately to prevent weed establishment.

Dense ground cover enhances soil structure from root activity, does not have the tendency to float during heavy rain events, inhibits weed establishment, provides additional aesthetic appeal, and is

recommended when high heavy metal loading is not anticipated. Mulch is recommended in conjunction with the ground cover until ground cover is established.

Research indicates that most attenuation of heavy metals in bioretention cells occurs in the first 1 to 2 inches of the mulch layer. That layer can be removed or added to as part of a standard and periodic landscape maintenance procedure. No indications of special disposal needs are indicated at this time from older bioretention BMPs in the eastern United States (personal communication between C. Hinman and L. Coffman).

In bioretention areas where higher flow velocities are anticipated, aggregate mulch may be used to dissipate flow energy and protect underlying BSM. Aggregate mulch varies in size and type, but 1- to 1.5-inch gravel (rounded) decorative rock is typical.

## **Design Procedure**

Bioretention BMP design uses hydrologic analysis methods, such as the Soil Conservation Service (SCS) or the Santa Barbara Urban Hydrograph (SBUH), to determine the quantity of runoff from the water quality design storm and then route the flow through the infiltration BMP to determine whether the runoff treatment requirements for [2.7.6 Core Element #5: Runoff Treatment](#) and the design requirements are met. See [Chapter 4 - Hydrologic Analysis and Design](#) for more information on hydrologic analysis methods. If designing bioretention for flow control to meet [2.7.7 Core Element #6: Flow Control](#), also see [6.3.3 General Criteria for Infiltration BMPs](#).

The stepwise procedure for designing bioretention for runoff treatment includes the following:

1. Determine the water quality design volume (V). See [Chapter 4 - Hydrologic Analysis and Design](#).
2. Determine subgrade long-term design infiltration rate. Estimate the measured (e.g., short-term) infiltration rate of the native soils beneath the bioretention soil and any base materials. Because these soils are protected from fouling, no correction factor need be applied.
3. Determine the long-term design infiltration rate of the BSM. Estimate the initial infiltration rate and apply (divide by) the appropriate correction factor based on the amount of contributing area to the BMP:
  - If using the default BSM provided in this manual, use 6 in/hr for the initial infiltration rate.
  - If using a custom BSM, determine its saturated hydraulic conductivity ( $K_{sat}$ ) and use that value as the initial infiltration rate.
  - For both the default and custom BSM, divide the initial infiltration rate by the appropriate correction factor (2 or 4, depending on contributing areas, as detailed in [Table 5.16: Sizing Methods and Assumptions for Bioretention](#)) to determine the long-term design infiltration rate of the BSM.
4. Define the bioretention BMP geometry, including bottom width, longitudinal slope, side slopes, BSM depth, and ponding area depth (including maximum ponding depth and freeboard).
5. Define the available storage in the bioretention BMP, including storage in the ponding area and in the voids of the BSM. For BMPs with longitudinal slopes > 1%, account for the reduced

available storage volume due to slopes. Also account for the effect of weirs or check dams on available storage volume, if applicable.

6. If designs include an underdrain, account for the reduced or eliminated infiltration benefits of the system when analyzing flow control ([Chapter 6 - Flow Control BMP Design](#)) and/or runoff treatment performance. If using level-pool routing per [4.7 Level-Pool Routing Method](#), the stage-storage-discharge relationship in the level-pool routing analysis would be redefined to include the ponding, bioretention soil mix, and underdrain layers for estimation of the stage-volume relationship. Infiltration would be reduced to account only for infiltration beneath the underdrain pipe invert elevation (or set to zero), and flow through the underdrain would be included in the stage-discharge relationship.
7. Conduct hydrologic analysis to confirm and/or iterate BMP sizing to meet [2.7.6 Core Element #5: Runoff Treatment](#) requirements. Include any orifice or other flow control structures and overflow BMPs in the analysis, as applicable. See [Chapter 4 - Hydrologic Analysis and Design](#) for hydrologic analysis methods. Check that the design freeboard and maximum drawdown time of 72 hours are met. Also see [Chapter 6 - Flow Control BMP Design](#) if designing bioretention to meet [2.7.7 Core Element #6: Flow Control](#).

[Table 5.16: Sizing Methods and Assumptions for Bioretention](#) summarizes the methods and assumptions for the above steps for sizing bioretention BMPs.

**Table 5.16: Sizing Methods and Assumptions for Bioretention**

Step	Variable	Methods and Assumptions <sup>a</sup>
1	Water Quality Design Volume	See <a href="#">Chapter 4 - Hydrologic Analysis and Design</a>
2	Long-Term Infiltration Rate of Subgrade Soils	<ul style="list-style-type: none"> <li>Estimate the infiltration rate of subgrade soils per <a href="#">6.3.3 General Criteria for Infiltration BMPs</a>.</li> <li>No correction factor needed since the overlying BSM helps protect long-term infiltration capacity of the subgrade soils.</li> </ul>
3	Long-Term Infiltration Rate of BSM	<ul style="list-style-type: none"> <li>When using the default BSM mix in this manual: <ul style="list-style-type: none"> <li>Use correction factor of 2, resulting in 3 in/hr (6 in/hr / 2) long-term infiltration rate for contributing area &lt; 5,000 sf of PGIS; &lt; 10,000 sf of impervious surface; and &lt; 0.75 acre of lawn, landscape, and other pervious surface.</li> <li>Use correction factor of 4, resulting in 1.5 in/hr (e.g., 6 in/hr / 4) for larger PGISs; impervious surfaces; or lawn, landscape or other pervious surface.</li> </ul> </li> <li>When using a custom BSM mix: <ul style="list-style-type: none"> <li>Estimate <math>K_{sat}</math> (initial infiltration rate) per Section 6.3.3.</li> <li>Divide by correction factor of 2 or 4, depending on contributing area (see above contributing area thresholds in this cell).</li> </ul> </li> </ul>
4, 5	Bottom Width	Minimum = 2 feet (recommended)
4, 5	Bottom Slope	<ul style="list-style-type: none"> <li>Minimum = 1%</li> <li>Maximum = 8% (recommended; can go steeper with weirs, per local jurisdiction requirements)</li> <li>Evaluate use of underdrain for slope &lt; 2%</li> </ul>
4, 5	Side Slopes	Maximum = 3H:1V (recommended unless rockeries or walls used).
4, 5	Ponding Area Depth	<ul style="list-style-type: none"> <li>Maximum ponding depth = 12 inches</li> <li>Minimum freeboard per local jurisdiction requirement</li> </ul>
4, 5	BSM Depth	<ul style="list-style-type: none"> <li>Minimum for runoff treatment = 18 inches</li> <li>Minimum for improved P and N removal (with underdrains) = 24 inches (recommended)</li> </ul>
5	BSM Porosity	<ul style="list-style-type: none"> <li>Per design</li> <li>Typical range = 35% to 45%</li> </ul>
5	Check Dams	If used, only include the effective storage available behind check dams and

**Table 5.16: Sizing Methods and Assumptions for Bioretention  
(continued)**

Step	Variable	Methods and Assumptions <sup>a</sup>
	and Weirs	weirs in the modeled volume.
6	Underdrain Pipe	<ul style="list-style-type: none"> <li>• Minimum pipe diameter = 4 inches</li> <li>• Minimum slope = 0.5%</li> <li>• Invert elevation per design</li> </ul>
7	Orifices/Flow Control Structures	Per design
7	Overflow	Per design
7	Drawdown	Maximum = 72 hours after cessation of flow to the BMP
<sup>a</sup> See local jurisdiction requirements for locally required methods and assumptions where applicable.		

### **Construction Criteria**

Prior to construction, meet with contractor, subcontractors, construction management, and inspection staff to review critical design elements and confirm specification requirements, proper construction procedures, construction sequencing, and inspection timing. Runoff from construction activity should not be allowed into the bioretention areas unless there is no other option for conveying construction stormwater, there is adequate protection of the subgrade soil and BSM, and introduction of stormwater is approved by a licensed professional.

### **Excavation**

Soil compaction can lead to BMP failure; accordingly, minimizing compaction of the base and sidewalls of the bioretention area is critical. Excavation should never be allowed during wet or saturated conditions (compaction can reach depths of 2 to 3 feet during wet conditions and mitigation is likely not possible). Excavation should be performed by machinery operating adjacent to the bioretention BMP and no heavy equipment with narrow tracks, narrow tires, or large lugged, high-pressure tires should be allowed on the bottom of the bioretention BMP. If machinery must operate in the bioretention cell for excavation, use lightweight equipment with low ground-contact pressure, and rip the base at completion to refracture soil to a minimum of 12 inches. If machinery operates in the BMP, subgrade infiltration rates must be field tested and compared to design rates and verified by a licensed professional. Failure to meet or exceed the design infiltration rate for the subgrade will require revised engineering designs to verify achievement of treatment and flow control benefits that were estimated in the Stormwater Site Plan.

Prior to placement of the BSM, the finished subgrade should:

- Be scarified to a minimum depth of 3 inches:
- Be cleared of any sediment deposited by construction runoff (to remove all introduced sediment, subgrade soil should be removed to a depth of 3 to 6 inches and replaced with

BSM): and

- Be inspected by a licensed professional to verify required subgrade condition.

Sidewalls of the BMP beneath the surface of the BSM can be vertical if soil stability is adequate. Exposed sidewalls of the completed bioretention area with BSM in place should be no steeper than 3H:1V. The bottom of the BMP should be flat.

Vegetation protection areas with intact native soil and vegetation should not be cleared and excavated for bioretention BMPs.

## **Bioretention Soil Media Installation**

### **Placement**

On-site soil mixing or placement should not be performed if BSM or subgrade soil is saturated. The bioretention soil mixture should be placed and graded by machinery operating adjacent to the bioretention BMP. If machinery must operate in the bioretention cell for soil placement, use lightweight equipment with low ground-contact pressure. If machinery operates in the BMP, the BSM infiltration rates must be field tested and compared to design rates and verified by a licensed professional. Failure to meet or exceed the design infiltration rate for the BSM will require revised engineering designs to verify achievement of treatment and flow control requirements. The soil mixture should be placed in horizontal layers not to exceed 12 inches per lift for the entire area of the bioretention BMP.

Compact the BSM to a relative compaction of 85% of modified maximum dry density (ASTM D1557-12). Compaction can be achieved by boot packing (simply walking over all areas of each lift) and then apply 0.2 inches of water per 1 inch of BSM depth. Water for settling should be applied by spraying or sprinkling.

### **Verification**

If using the approved BSM guidelines in this manual (see [Determining Subgrade and Bioretention Soil Media Design Infiltration Rates](#)), preplacement laboratory analysis for saturated hydraulic conductivity of the BSM is not required.

If a different BSM is used, then verification of the BSM composition (2% to 5% passing the No. 200 sieve, 4% to 8% organic matter content, CEC > 5 milliequivalents (meq)/100 grams (g) dry soil, and pH in the range of 5.5 to 7) and hydraulic conductivity (initial rate < 12 in/hr and a long-term rate > 1 in/hr) should be provided before placement through laboratory testing of the material that will be used in the installation.

BSM infiltration rates are determined per ASTM Designation D2434-68 (Standard Test Method for Permeability of Granular Soils) at 85% compaction per ASTM Designation D1557-12 (Standard Test Methods for Laboratory Compaction Characteristics of Soil Using Modified Effort). Determine the organic matter content before and after permeability test using ASTM D2974-07a (Standard Test Method for Moisture, Ash, and Organic Matter of Peat and Other Organic Soils).

Testing should be performed by a laboratory accredited by the Seal of Testing Assurance, American Association of State Highway and Transportation Officials (AASHTO), ASTM International, or other laboratory with current and maintained accreditation from a standards organization. Samples of the BSM that will be placed in the bioretention areas must be supplied for testing.

## **Geotextiles**

Geotextiles between the subgrade and the BSM are typically not needed. The gradation between existing soils and BSM is generally not great enough to allow significant migration of fines into the BSM. Additionally, geotextiles may clog with downward migrating fines from the BSM.

## **Erosion and Sediment Control (ESC)**

Controlling erosion and sediment are most difficult during clearing, grading, and construction; accordingly, minimizing site disturbance to the greatest extent practicable is the most effective sediment management. The following recommendations apply to the construction period:

- Bioretention areas should not be used as sediment control BMPs and all drainage should be directed away from bioretention areas after initial rough grading. Flow can be directed away from the BMP with temporary diversion swales or other approved protection ([Prince George's County, 2007](#)).
- Construction on bioretention BMPs should not begin until all contributing areas are stabilized according to erosion and sediment control BMPs and to the satisfaction of a licensed professional.
- If the design includes curb and gutter, the curb cuts and inlets should be blocked until BSM and mulch have been placed and planting completed (when possible), and dispersion pads are in place.

Every effort should be made during design, construction sequencing, and construction to prevent sediment from entering bioretention areas. However, bioretention areas are often distributed throughout the project area and can present unique challenges during construction. Minimizing sedimentation, removing sediment from bioretention areas, and replacing any soil removed with new BSM when project is complete are necessary for a proper functioning system. Deep compaction in bioretention areas is very difficult, if not possible, to mitigate and must be prevented.

**Note:** Erosion and sediment control practices should be inspected and maintained on a regular basis.

## ***Operation and Maintenance Criteria***

Bioretention areas require periodic plant, soil, and mulch layer maintenance to ensure optimum infiltration, storage, and pollutant removal capabilities. Providing more frequent and well-timed maintenance (e.g., weeding prior to seed dispersal) during the first 3 years will ensure greater success and reduce future maintenance of bioretention areas. In general, bioretention maintenance recommendations are typical landscape care procedures and include the following:

- **Watering:** Plants should be selected to be drought tolerant and not require watering after establishment (2 to 3 years). In more arid environments, watering may be needed during prolonged dry periods after plants are established.
- **Erosion control:** Inspect flow entrances, ponding area, and surface overflow areas periodically, and replace soil, plant material, and/or mulch layer in areas if erosion has occurred. Properly designed BMPs with appropriate flow velocities should not have erosion problems

except perhaps in extreme events. If erosion problems occur, the following should be reevaluated and adjusted as needed:

1. amount of contributing area draining to the BMP;
2. flow velocities and gradients within the cell; and
3. flow dissipation and erosion protection strategies in the pretreatment area and flow entrance.

If sediment is deposited in the bioretention area, immediately determine the source within the contributing area, stabilize, and remove excess surface deposits.

- **Sediment removal:** Follow the maintenance plan schedule for visual inspection and remove sediment if the volume of the ponding area has been compromised.
- **Plant material:** Depending on safety (pedestrian obstruction or site distances) and aesthetic requirements, occasional pruning and removing dead plant material may be necessary. Replace all dead plants, and if specific plants have a high mortality rate, assess the cause and replace with appropriate species. Periodic weeding is necessary until plants are established and adequately shade and capture the site from weed establishment.
- **Weeding:** Invasive or nuisance plants should be removed regularly and not allowed to accumulate and exclude planted species. At a minimum, schedule weeding with inspections to coincide with important horticultural cycles (e.g., prior to major weed varieties dispersing seeds). Weeding should be done manually and without herbicide applications. The weeding schedule should become less frequent if the appropriate plant species and planting density are used and the selected plants grow to capture the site and exclude undesirable weeds.
- **Nutrients and pesticides:** The soil mix and plants are selected for optimum fertility, plant establishment, and growth. Nutrient and pesticide inputs should not be required and may degrade the pollutant processing capability of the bioretention area as well as contribute pollutant loads to receiving waters. By design, bioretention areas are located in areas where phosphorus and nitrogen levels may be elevated, and these should not be limiting nutrients. If in question, have soil analyzed for fertility.
- **Mulch:** Replace mulch annually in bioretention areas where heavy metal deposition is high (e.g., contributing areas that include gas stations, ports, and roads with high traffic loads). In residential settings or other areas where metal or other pollutant loads are not anticipated to be high, replace or add mulch as needed (likely 3 to 5 years) to maintain a 2- to 3-inch depth.
- **Soil:** Soil mixes for bioretention BMPs are designed to maintain long-term fertility and pollutant processing capability. Estimates from metal attenuation research suggest that metal accumulation should not present an environmental concern for at least 20 years in bioretention BMPs. Replacing mulch in bioretention BMPs where heavy metal deposition is likely provides an additional level of protection for prolonged performance. If in question, have soil analyzed for fertility and pollutant levels.

**For more information:** See [Appendix 5-A: Recommended Maintenance Criteria for Runoff Treatment BMPs](#) for recommended maintenance criteria.



## **BMP T5.32: Permeable Pavement**

See [BMP F6.24: Permeable Pavement](#) for discussion of permeable pavement design, construction, and maintenance criteria for flow control applications. In addition to flow control, permeable pavement may also be used to satisfy runoff treatment requirements provided that the Site Suitability Criteria are met.

## **5.5 Biofiltration BMPs**

### **5.5.1 Purpose**

Biofiltration Best Management Practices (BMPs) are vegetated treatment systems (typically grass) that remove pollutants by means of sedimentation, filtration, soil sorption, and/or plant uptake. They are typically configured as swales or filter strips. Three biofiltration BMPs are described in this section:

- [BMP T5.40: Biofiltration Swale](#)
- [BMP T5.50: Vegetated Filter Strip](#)
- [BMP T5.60: Compost-Amended Vegetated Filter Strip \(CAVFS\)](#)

### **5.5.2 Application**

Biofiltration BMPs can be used as a basic treatment BMP for contaminated runoff from roadways, driveway, parking lots, and highly impervious ultraurban areas or as the first stage of a treatment train. In cases where hydrocarbons, high total suspended solids (TSS), or debris would be present in the runoff, such as high-use sites, a pretreatment system for those components would be necessary.

[Table 5.17: Applicability of Biofiltration BMPs for Runoff Treatment, Flow Control, and Conveyance](#) summarizes the applicability of biofiltration BMPs for runoff treatment, flow control, and conveyance. In this table, check marks indicate that the BMP may be used on its own for the given application; “PT” indicates that the BMP may be used with appropriate pretreatment; and “TT” indicates that the BMP may be used as part of a treatment train for phosphorus and/or metals treatment.

Selection of a specific BMP should be coordinated with the runoff treatment BMP options provided in [5.2 Runoff Treatment BMP Selection Process](#). Off-line location is preferred to avoid flattening vegetation and the erosive effects of high flows.

**Table 5.17: Applicability of Biofiltration BMPs for Runoff Treatment, Flow Control, and Conveyance**

BMP	Runoff Treatment					Flow Control	Conveyance
	Pretreatment	Basic	Metals	Oil Control	Phosphorus		
<a href="#">BMP T5.40: Biofiltration Swale</a>		PT <sup>a</sup>	PT <sup>a</sup> , TT <sup>b</sup>		PT <sup>a</sup> , TT <sup>b</sup>		✓
<a href="#">BMP T5.50: Vegetated Filter Strip</a>		PT <sup>a</sup>	PT <sup>a</sup> , TT <sup>b</sup>		PT <sup>a</sup> , TT <sup>b</sup>		
<a href="#">BMP T5.60: Compost-Amended Vegetated Filter Strip (CAVFS)</a>		PT <sup>a</sup>	✓	✓ <sup>c</sup>			

<sup>a</sup> In cases where hydrocarbons, high total suspended solids (TSS), or debris is present in the runoff, a pretreatment system (PT) would be necessary.

<sup>b</sup> BMP may be used as the first stage of a treatment train (TT) for metals and phosphorus control.

<sup>c</sup> High-use roadway and parking areas only (see the latest version of the WSDOT *Highway Runoff Manual*).

### 5.5.3 Cold Weather Climate Considerations

Biofiltration BMPs have reduced effectiveness in the winter because of dormant vegetation. These BMPs can be effective for snow storage and meltwater infiltration if road salt/deicing chemicals/chlorides are not used excessively. See [5.2.4 Cold Weather Considerations](#) for additional cold weather considerations related to cold temperatures, deep frost line, short growing season, and/or significant snowfall.

### 5.5.4 Arid/Semiarid Climate Considerations

Vegetation is integral to the proper function of biofiltration BMPs. In arid/semiarid portions of eastern Washington, plants should be selected to be drought tolerant and not require watering after establishment (2 to 3 years) unless irrigation is planned. In more arid environments, watering may be needed during prolonged dry periods after plants are established. See [Table 5.10: Infiltration Rates for Surface Infiltration and Bioinfiltration BMPs](#) for additional considerations based on average annual rainfall.

## 5.5.5 BMPs for Biofiltration

### Introduction to BMPs for Biofiltration

General criteria, design procedures, construction criteria, and operation and maintenance criteria for biofiltration BMPs are provided in the following subsections.

#### BMP T5.40: Biofiltration Swale

Biofiltration is the simultaneous process of filtration, particle settling, adsorption, and biological uptake of pollutants in stormwater that occurs when runoff flows over and through vegetated areas. A biofiltration swale is a sloped, vegetated channel or ditch that provides both conveyance and runoff treatment to stormwater runoff. It does not provide flow control but can convey runoff to Best Management Practices (BMPs) designed for that purpose.

**Note:** Underground Injection Control (UIC) regulations do not apply to biofiltration swales (see [5.6 Subsurface Infiltration \(Underground Injection Control Wells\)](#)).

#### General Criteria

- Though the actual dimensions for a specific site may vary, the swale should generally have a length of 200 feet. The maximum bottom width is typically 10 feet. The depth of flow should not exceed 4 inches during the design storm. The flow velocity should not exceed 1 foot per second (ft/sec).
- The channel slope should be > 1% and < 5%.
- The swale can be sized as both a runoff treatment BMP for the 6-month storm and as a conveyance BMP to pass the peak hydraulic flows of the 25-year storm if it is located “online.”
- The ideal cross section of the swale should be a trapezoid. The side slopes should be no steeper than 3:1.
- Roadside ditches should be regarded as significant potential biofiltration sites and should be used for this purpose whenever possible.
- If flow is to be introduced through curb cuts, place pavement slightly above the biofiltration swale elevation. Curb cuts should be ≥ 12 inches wide to prevent clogging.
- Biofiltration swales must be vegetated in order to provide adequate treatment of runoff. Select vegetation that does not require fertilizer inputs or frequent mowing.
- It is important to maximize water contact with vegetation and the soil surface. For general purposes, select fine, close-growing grasses (or other vegetation) that can withstand prolonged periods of wetting, as well as prolonged dry periods (to minimize the need for irrigation). Consult the local Natural Resources Conservation Service (NRCS) office or the County Extension Service for specific vegetation selection recommendations.
- Biofiltration BMPs should generally not receive construction-stage runoff. If they do, presettling of sediments should be provided. See [BMP C240E: Sediment Trap](#) and [BMP](#)

[C241E: Sediment Pond \(Temporary\)](#). Such biofiltration BMPs should be evaluated for the need to remove sediments and restore vegetation following construction. The maintenance of presettling basins or sumps is critical to their effectiveness as pretreatment devices.

- If possible, divert runoff (other than necessary irrigation) during the period of vegetation establishment. Where runoff diversion is not possible, protect graded and seeded areas with suitable erosion control measures.

## **Design Procedure**

The stepwise procedure for designing biofiltration swales for runoff treatment includes the following:

1. Determine the water quality design flow rate to the biofiltration swale. See [Chapter 4 - Hydrologic Analysis and Design](#).
2. Determine the slope of the biofiltration swale.
3. Select a shape for the biofiltration swale. The remainder of the design process assumes that a trapezoidal shape has been selected; however, rectangular and triangular shapes can also be used.
4. Use Manning's Equation to estimate the bottom width of the biofiltration swale. Manning's Equation for English units is as follows:

### **Equation 5.3: Manning's Equation**

$$Q = (1.486 * A * R^{0.667} * S^{0.5}) / n$$

where:

Q = flow (cfs)

A = cross-sectional area of flow (square feet [sf])

R = hydraulic radius of flow cross section (feet [ft])

S = longitudinal slope of biofiltration swale (feet per foot [ft/ft])

n = Manning's roughness coefficient.

Values for grasses range from 0.15 to 0.40.

Use n = 0.30 for a typical biofiltration swale with turf/lawn vegetation.

Use n = 0.20 for a biofiltration swale with less dense vegetation such as meadow or pasture;  
or

Use other n values for specific site vegetation as determined by the designer.

These values may be subject to approval by the local jurisdiction.

For a trapezoid, [Equation 5.3: Manning's Equation](#) cannot be directly solved for bottom width. However, for trapezoidal channels that are flowing very shallow, the hydraulic radius can be set equal to the depth of flow. Using this assumption, [Equation 5.3: Manning's Equation](#) can be altered to the following for n = 0.20:

**Equation 5.4: Biofiltration Swale Bottom Width for a Manning's n of 0.20**

$$B = (0.135 * Q) / (y^{1.667} * S^{0.5}) - (Z * y)$$

where:

B = bottom width of the biofiltration swale (ft)

Q = flow (cfs)

y = depth of flow (ft)

S = longitudinal slope of biofiltration swale (ft/ft)

Z = the side slope of the biofiltration swale in the form of z:1

For other values of n, use the following equation:

**Equation 5.5: Biofiltration Swale Bottom Width**

$$B = ([n / 1.486] * Q) / (y^{1.667} * S^{0.5}) - (Z * y)$$

5. Calculate the cross-sectional area of flow for the given channel using the calculated bottom width and the selected side slopes and depth of flow.

**Equation 5.6: Biofiltration Swale Cross-Sectional Area of Flow**

$$A = (B * y) + (Z * y)^2$$

where:

A = cross-sectional area of flow (sf)

B = bottom width of the biofiltration swale (ft)

y = depth of flow (ft)

Z = the side slope of the biofiltration swale in the form of z:1

6. Calculate the velocity of flow in the channel using:

**Equation 5.7: Biofiltration Swale Velocity of Flow**

$$V = Q / A$$

where:

V = velocity of flow (ft/sec)

Q = flow (cfs)

A = cross-sectional area of flow (sf)

If  $V \leq 1$  ft/sec for the water quality design flow rate, the biofiltration swale will function correctly with the selected bottom width. Proceed to design Step 7.

If  $V > 1$  ft/sec for the water quality design flow rate, the biofiltration swale will not function correctly. Increase the bottom width, recalculate the depth using Manning's Equation, and return to design Step 5.

7. Select a location where a biofiltration swale with the calculated bottom width and length will fit. If the calculated length is not possible, increase the bottom width so that the bottom area divided by the bottom width is equal to the calculated length.
8. Select a vegetation cover suitable for the site.
9. Determine the total depth of channel, to include freeboard above the depth of flow during the 25-year 24-hour storm. A 10-year storm may be used instead provided that reparative maintenance will be performed following every 10-year storm event.
10. Check to determine that the maximum velocity for the total depth of channel (as described in Step 9) does not cause erosion; the maximum velocity must be  $< 2$  ft/sec. This step can be skipped if all storms larger than the short-duration water quality storm bypass the biofiltration swale.

[Table 5.18: Sizing Methods and Assumptions for Biofiltration Swales](#) summarizes the methods and assumptions for the above steps for sizing biofiltration swales.

**Table 5.18: Sizing Methods and Assumptions for Biofiltration Swales**

Steps	Variable	Methods and Assumptions
1	Water Quality Design Flow Rate (Q) <sup>a</sup>	See <a href="#">Chapter 4 - Hydrologic Analysis and Design</a> for methods for computing design storms.
2	Bottom Slope (S)	<ul style="list-style-type: none"> <li>• Minimum = 1%</li> <li>• Maximum = 5%</li> <li>• Evaluate use of underdrainage for slope <math>&lt; 2\%</math></li> </ul>
3	Shape of Swale	Trapezoidal is most desirable, but rectangular shapes can also be used.
4	Manning's n	<ul style="list-style-type: none"> <li>• Select Manning's n based on the vegetative cover type selected for the swale (see <a href="#">Equation 5.3: Manning's Equation</a>).</li> <li>• Typically, <math>n = 0.04</math> during the 25-year flow; n may need to be adjusted if a 10-year event is used.</li> <li>• Consult the local NRCS office or the County Extension Service for guidance.</li> </ul>
4, 5	Flow Depth (y)	<ul style="list-style-type: none"> <li>• Default = 4 inches for turf grass</li> <li>• Default = 3 inches for dryland grasses</li> <li>• Can be set lower, but doing so will increase the bottom width (B).</li> </ul>
4, 5, 7	Bottom Width	<ul style="list-style-type: none"> <li>• Use Manning's Equation (<a href="#">Equation 5.3: Manning's Equation</a>) to solve for</li> </ul>

**Table 5.18: Sizing Methods and Assumptions for Biofiltration Swales (continued)**

Steps	Variable	Methods and Assumptions
	(B)	<p>bottom width (B).</p> <ul style="list-style-type: none"> <li>• Minimum = 1 foot</li> <li>• Maximum = 10 feet</li> <li>• For larger bottom widths, parallel biofiltration swales should be used in conjunction with a device that splits the flow and directs the proper amount to each biofiltration swale.</li> <li>• For very low flow rates, Manning's Equation may generate a negative value for B. B should be set to 1 foot in these cases.</li> </ul>
4, 5	Cross-Sectional Area of Flow (A)	Use Manning's Equation ( <a href="#">Equation 5.3: Manning's Equation</a> ) to solve for cross-sectional area of flow given the bottom width (B), side slopes (Z), and flow depth (y).
6	Velocity at Water Quality Design Flow Rate (V)	<ul style="list-style-type: none"> <li>• Use <math>V = Q / A</math></li> <li>• If <math>V \leq 1</math> ft/sec for the water quality design flow rate, the biofiltration swale will function correctly with the selected bottom width.</li> <li>• If <math>V \geq 1</math> ft/sec, the biofiltration swale will not function correctly. Increase the bottom width (B), recalculate the flow depth (y) and cross-sectional area of flow (A) using Manning's Equation (<a href="#">Equation 5.3: Manning's Equation</a>).</li> </ul>
7	Length (L)	<ul style="list-style-type: none"> <li>• Minimum = 200 feet</li> <li>• If L = 200 feet is not possible, increase the bottom width (B) so that the cross-sectional area of flow (A) divided by the bottom width (B) is equal to 200 feet.</li> </ul>
9	Freeboard	Minimum = 1 foot
10	Velocity at Total Depth of Channel ( $V_{max}$ )	<ul style="list-style-type: none"> <li>• <math>V_{max} \leq 2</math> ft/sec</li> <li>• This step can be skipped if all storms larger than the short-duration water quality storm bypass the biofiltration swale.</li> </ul>
<p><sup>a</sup>See local jurisdiction requirements for calculating peak flow rates.</p>		

### Construction Criteria

The biofiltration swale should not be put into operation until areas of exposed soil in the contributing drainage catchment have been sufficiently stabilized. Deposition of eroded soils can impede the growth of grass in the swale and reduce swale treatment effectiveness. Thus, effective erosion and sediment control measures should remain in place until the swale vegetation is established (see [Chapter 7 - Construction Stormwater Pollution Prevention](#) for erosion and sediment control BMPs).

Avoid compaction during construction. Grade biofiltration swales to attain uniform longitudinal and lateral slopes.

### **Operation and Maintenance Criteria**

- Groomed biofiltration swales planted in grasses shall be mowed during the summer to promote growth and pollutant uptake.
- Remove sediments during summer months when they build up to between 2 and 4 inches at any spot, cover biofiltration swale vegetation, or otherwise interfere with biofiltration swale operation. Reseed bare spots created by removal equipment.
- Inspect biofiltration swales periodically, especially after periods of heavy runoff. Remove sediments, add compost as needed for long-term plant and soil health, and reseed as necessary. Avoid using fertilizer within the biofiltration swales wherever possible.
- Clean curb cuts when soil and vegetation buildup interferes with flow introduction.
- Remove litter to keep biofiltration swales free of external pollution.

See [Appendix 5-A: Recommended Maintenance Criteria for Runoff Treatment BMPs](#) for recommended maintenance criteria.

### **BMP T5.50: Vegetated Filter Strip**

Vegetated filter strips are primarily used adjacent and parallel to paved areas, such as parking lots or driveways and roadways. A vegetated filter strip is flat with no side slopes. Contaminated stormwater is distributed as sheet flow across the inlet width of the filter strip. Runoff treatment occurs by passage of water over the surface, and through grass.

See [Figure 5.15: Typical Vegetated Filter Strip](#) for a typical vegetated filter strip detail and [5.5.2 Application](#) for a summary of applicability for runoff treatment, flow control, and conveyance. Vegetated filter strips may be used as the first basic treatment Best Management Practice (BMP) in a two-BMP treatment train for phosphorus treatment. See [Table 5.1: Treatment Trains for Phosphorus Removal](#) for more information.

Underground Injection Control (UIC) regulations do not apply to vegetated filter strips (see [5.6 Subsurface Infiltration \(Underground Injection Control Wells\)](#)).

### **General Criteria**

- Along roadways, vegetated filter strips should be placed  $\geq 1$  foot, and preferably 3 to 4 feet from the edge of pavement, to accommodate a vegetation free zone.
- Once stormwater runoff has been treated by a vegetated filter strip, it may need to be collected and conveyed to a flow control BMP.
- The flow from the roadway must enter the vegetated filter strip as sheet flow.
- Vegetated filter strips must not receive concentrated flow discharges.
- A maximum flow path of 30 feet each can contribute to a vegetated filter strip designed via the



method described in the Design Procedure section.

- Vegetated filter strips should be used where the average daily traffic (ADT) on the roadway is < 30,000.
- Vegetated filter strips should not be used on roadways with longitudinal slopes > 5% because of the difficulty in maintaining the necessary sheet flow conditions.
- Vegetated filter strips should be constructed after other portions of the project are completed.
- Vegetated filter strip beds should have a final organic content of 5% for grass and 10% for shrub areas.
- Vegetated filter strips should be constructed outside the natural stream buffer area whenever possible to maintain a more natural buffer along the streambank.
- Use of vegetated filter strips may be limited to crowned roads where vegetated filter strips can be added along both sides of the road. It should not be used for banked roads that drain solely to one side without additional analysis to account for the extended flow path length.

## ***Design Procedure***

The sizing of the vegetated filter strip is based on a 3-step procedure:

1. Determine the length of flow path (FL), defined as the length of the flow path from the upstream to the downstream edge of the impervious area draining to the BMP.
2. Calculate the average longitudinal or cross slope (S) of the filter strip (along the direction of sheet flow), averaged over the total width of the filter strip.
3. Determine the required length of the filter strip (L).

[Table 5.19: Sizing Methods and Assumptions for Vegetated Filter Strips](#) summarizes the methods and assumptions for the above steps for sizing vegetated filter strips.

**Table 5.19: Sizing Methods and Assumptions for Vegetated Filter Strips**

Step	Variable	Methods <sup>a</sup> and Assumptions
1	Length of Flow Path (FL)	<ul style="list-style-type: none"> <li>• Typically equal to the width of the paved area, but may be longer depending on slope/topography.</li> <li>• For crowned roadways, L may be one-half the width of the roadway.</li> </ul>
2	Longitudinal or Cross-Slope (S)	<ul style="list-style-type: none"> <li>• <math>2\% \leq S \leq 20\%</math></li> <li>• The vegetated filter strip can be stepped down so that the <math>S \leq 20\%</math> criterion is not exceeded.               <ul style="list-style-type: none"> <li>◦ Drop sections must be provided with erosion protection at the base and flow spreaders to respread flows.</li> <li>◦ Drops &lt; 12 inches in height.</li> </ul> </li> <li>• Select a different BMP if all of these criteria cannot be met.</li> </ul>
3	Length of Filter Strip (L)	<ul style="list-style-type: none"> <li>• Use <a href="#">Figure 5.14: Vegetated Filter Strip Design Graph</a> or an approach based on determining the hydraulic residence time of runoff to size the filter strip.               <ul style="list-style-type: none"> <li>◦ Find curve representing the appropriate length of the flow path (FL).</li> <li>◦ Interpolate between curves as necessary.</li> <li>◦ Identifying appropriate filter strip lengths (L) for flow path lengths (FL) &gt; 30 feet may require additional analysis for practical application.</li> </ul> </li> <li>• Find the point along the curve where the design longitudinal or cross slope (S) of the filter strip is directly below and read the filter strip length (L) to the left on the y axis.</li> <li>• Minimum required filter strip length (L):               <ul style="list-style-type: none"> <li>◦ 4 feet for FL ≤ 10 feet</li> <li>◦ 4.5 feet for FL = 25 feet</li> <li>◦ 5.5 feet for FL = 30 feet</li> </ul> </li> <li>• Provide the minimum required length or more along the entire stretch of pavement draining to it.</li> </ul>
<p><sup>a</sup>Sizing procedure is based on the narrow area filter strips presented in the King County Surface Water Design Manual (<a href="#">King County, 2016</a>).</p>		

## ***Construction Criteria***

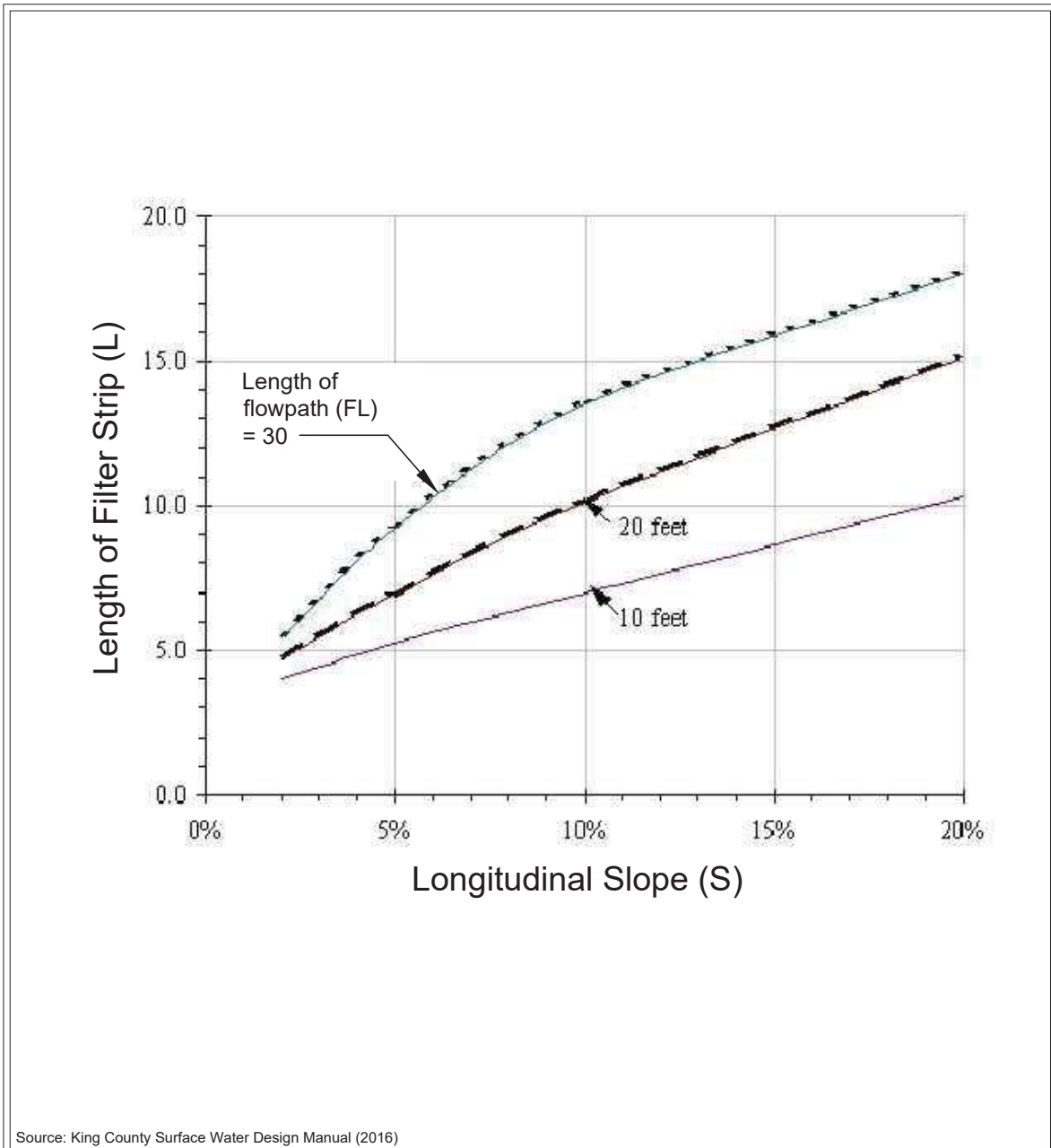
The filter strip should not be put into operation until areas of exposed soil in the contributing drainage catchment have been sufficiently stabilized. Deposition of eroded soils can impede the growth of grass in the filter strip and reduce filter strip treatment effectiveness. Thus, effective erosion and sediment control measures should remain in place until the filter strip vegetation is established (see [Chapter 7 - Construction Stormwater Pollution Prevention](#) for erosion and sediment control BMPs). Avoid compaction during construction.

## ***Operation and Maintenance Criteria***

- Grass filter strips should be mowed during the summer to promote growth.
- Inspect filter strips periodically, especially after periods of heavy runoff. Remove sediments and reseed as necessary. Catch basins or sediment sumps that precede filter strips should be cleaned to maintain proper function.

**For more information:** See [Appendix 5-A: Recommended Maintenance Criteria for Runoff Treatment BMPs](#) for recommended maintenance criteria.

**Figure 5.14: Vegetated Filter Strip Design Graph**



Source: King County Surface Water Design Manual (2016)

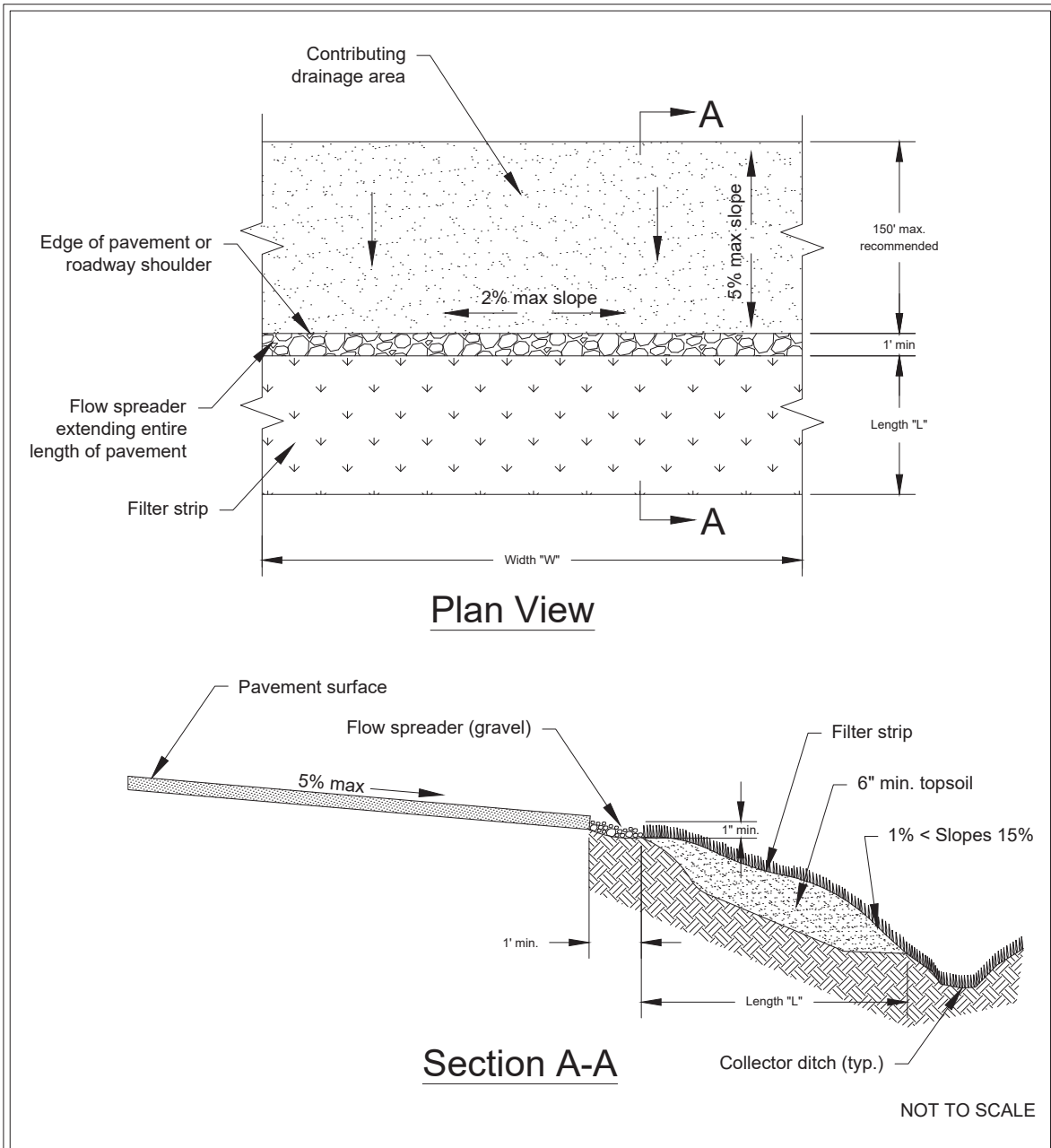


## Vegetated Filter Strip Design Graph

Revised March 2018

Please see <http://www.ecy.wa.gov/copyright.html> for copyright notice including permissions, limitation of liability, and disclaimer.

**Figure 5.15: Typical Vegetated Filter Strip**



## Typical Vegetated Filter Strip

Revised March 2018

Please see <http://www.ecy.wa.gov/copyright.html> for copyright notice including permissions, limitation of liability, and disclaimer.

## **BMP T5.60: Compost-Amended Vegetated Filter Strip (CAVFS)**

The CAVFS is a variation of the basic vegetated filter strip that adds soil amendments to the roadside embankment. The soil amendments improve infiltration characteristics, increase surface roughness, and improve plant sustainability. Once permanent vegetation is established, the advantages of the CAVFS are higher surface roughness; greater retention and infiltration capacity; improved removal of soluble cationic contaminants through sorption; improved overall vegetative health; and a reduction of invasive weeds. Compost-amended systems have somewhat higher construction costs due to more expensive materials, but require less land area for runoff treatment, which can reduce overall costs.

### **General Criteria**

See the latest version of the Washington State Department of Transportation (WSDOT) *Highway Runoff Manual* (HRM) for general criteria.

### **Design Procedure**

See the latest version of the WSDOT HRM for design procedures for sizing in eastern Washington.

### **Construction Criteria**

See the latest version of the WSDOT HRM for construction criteria.

### **Operation and Maintenance Criteria**

Compost, as with sand filters or other filter media, can become plugged with fines and sediment, which may require removal and replacement. Including vegetation with compost helps prevent the medium from becoming plugged with sediment by breaking up the sediment and creating root pathways for stormwater to penetrate into the compost. It is expected that soil amendments will have a removal and replacement cycle; however, this time frame has not yet been established.

**For more information:** See [Appendix 5-A: Recommended Maintenance Criteria for Runoff Treatment BMPs](#) for recommended maintenance criteria.

## **5.6 Subsurface Infiltration (Underground Injection Control Wells)**

### **5.6.1 Introduction to UIC Wells**

[5.6 Subsurface Infiltration \(Underground Injection Control Wells\)](#) defines site suitability, treatment requirements, and design criteria for discharges of stormwater to Underground Injection Control (UIC) wells. The requirements of this chapter may be superseded by the Industrial Stormwater General Permit for those permitted sites. See the [Glossary](#) and [1.4.6 Underground Injection Control Program](#) for the UIC well definition and a list of examples.

All UIC wells receiving stormwater, except those located on tribal lands and UIC wells at single-family homes receiving only residential roof runoff or used to control basement flooding, must be registered with the state of Washington. The majority of UIC wells receiving stormwater runoff can

be authorized by the UIC program without requiring individual permits, provided the non-endangerment standard is met by fulfilling the requirements detailed throughout [5.6 Subsurface Infiltration \(Underground Injection Control Wells\)](#). Subsurface infiltration (UIC wells) may be used to provide flow control for stormwater runoff under any of the following conditions:

- Pollutant concentrations expected to reach ground water will meet Washington State ground water quality standards.
- Stormwater is treated according to the requirements of this section prior to reaching the aquifer.
- Flows are greater than the water quality design storm (see [Chapter 4 - Hydrologic Analysis and Design](#)).

The unsaturated geologic material between the bottom of the UIC well and the top of an unconfined aquifer, herein called the vadose zone, usually provides some level of treatment by removing contaminants by filtration, adsorption, and/or degradation. In some cases, the treatment provided by the vadose zone is suitable for protecting ground water quality from contamination by stormwater runoff. In other cases, additional treatment may be required to protect ground water quality. [5.6.16 Determining Treatment Requirements](#) and [5.6.17 Classification of Vadose Zone Treatment Capacity](#) describe these assessments and their application.

[5.6 Subsurface Infiltration \(Underground Injection Control Wells\)](#) does not address the following:

- UIC wells that receive fluids other than stormwater (precluding accidental spills and illicit discharges, which are addressed in [Chapter 8 - Source Control](#))
- The infiltration capacity of the vadose zone below the UIC well
- The ability of the UIC well to meet local operational requirements to infiltrate a certain volume of water in a given amount of time (see [2.7.7 Core Element #6: Flow Control](#) for more detail on flow control)

The UIC rule, [WAC 173 218](#), requires a well assessment (see [5.6.5 Well Assessment](#)) for UIC wells that were constructed prior to February 3, 2006. The rule refers to these UIC wells as “existing” UIC wells.

The UIC program considers an infiltration trench where the design includes perforated pipe to be classified as a UIC well. Registration requirements do not apply to infiltration trenches without perforated pipes. Infiltration trenches designed, constructed, operated, and maintained according to the specifications in [BMP F6.22: Infiltration Trenches](#) and a UIC registration with Ecology can be rule-authorized by the presumptive approach (see [5.6.8 The Presumptive Approach](#)).

## **5.6.2 Rule-Authorization or Permit**

UIC wells must either be rule-authorized or covered by a state waste discharge permit to operate. If a UIC well is rule-authorized, an individual permit is not required. Rule-authorization can be rescinded if a UIC well no longer meets the non-endangerment standard, i.e., the discharge does not meet ground water quality standards.

A UIC well may be rule-authorized when both of the following required actions are completed:

- Submit a registration form to Ecology (unless the UIC well is on tribal land, then registration is through U.S. Environmental Protection Agency (U.S. EPA), Region 10).
- Protect ground water quality. The discharge from the UIC well must meet the non-endangerment standard.

### 5.6.3 Registration

Register UIC wells using Ecology’s online registration process. See the following website for details:

<https://ecology.wa.gov/Regulations-Permits/Guidance-technical-assistance/Underground-injection-control-program/Register-UIC-wells-online>

All UIC wells must be registered except: UIC wells at single-family homes (or duplexes) receiving only residential roof runoff used to collect stormwater runoff from roof surfaces on an individual home (or duplex) or for basement flooding control.

#### ***New UIC Wells***

Ecology considers UIC wells constructed on or after February 3, 2006, to be new wells. The registration provides Ecology with information to determine if the new UIC well meets the conditions to be rule-authorized:

- Applicants must submit the registration form 60 days prior to construction to allow for a full review of the application by Ecology and other interested stakeholders.
- The UIC well must meet the non-endangerment standard, i.e., it complies with all of the siting, design, and treatment requirements through either the presumptive approach ([5.6.8 The Presumptive Approach](#)) or the demonstrative approach ([5.6.9 The Demonstrative Approach](#)).

#### ***Existing UIC Wells***

The UIC rule considers UIC wells constructed prior to February 3, 2006, as “existing.” Existing wells used to manage stormwater runoff do not have to meet the new UIC well treatment requirements; however, registration is required if the UIC well is not already registered, and the owner must also complete a well assessment ([5.6.5 Well Assessment](#)) to determine if an existing UIC well is a high threat to ground water. See [WAC 173 218 090\(2\)](#) and Ecology’s UIC web page at the following address:

<https://ecology.wa.gov/Regulations-Permits/Guidance-technical-assistance/Underground-injection-control-program/Register-UIC-wells-online>

### 5.6.4 Meeting the Non-Endangerment Standard

According to [WAC 173-218-080\(3\)](#), UIC wells must be constructed, operated, and maintained in a manner that protects water quality.

#### ***New UIC Wells***

Ecology determines if a new UIC well is either rule-authorized or needs a state waste discharge permit based on whether the UIC well meets the non-endangerment standard.



Designers may use either the presumptive or the demonstrative approach described in [5.6.8 The Presumptive Approach](#) and [5.6.9 The Demonstrative Approach](#) to meet the non-endangerment standard. UIC wells installed according to the specifications throughout [5.6 Subsurface Infiltration \(Underground Injection Control Wells\)](#) are not considered a high threat to ground water.

### **Existing UIC Wells**

To determine compliance with the UIC rule, owners of existing UIC wells must complete a well assessment to determine if an existing UIC well is a high threat to ground water ([5.6.5 Well Assessment](#)). The owner of a UIC well that is a high threat to ground water must retrofit the well to protect ground water quality.

### **Requirements for Municipal UIC Wells**

The UIC program rule is the regulatory authority for UIC wells in Washington. The UIC program rule applies to Class V wells that receive stormwater regardless of whether a UIC well is located in a municipality permitted under the Phase II Municipal Stormwater National Pollutant Discharge Elimination System (NPDES) Permit for Eastern Washington (MS4 Permit).

The MS4 Permit does not authorize stormwater discharges to/from UIC wells unless the overflow or discharge from a UIC well drains to a NPDES municipal separate storm sewer system (MS4). In those cases, the MS4 Permit does authorize the discharge and the conditions of the MS4 Permit directly apply. For example, if a UIC well is designed to infiltrate the 10-year storm and route larger storms to the MS4, then the requirements of the MS4 Permit apply to the well.

To prevent redundancy between the NPDES and the UIC programs, the UIC program rule allows permitted MS4s that also own or operate Class V UIC wells to satisfy the UIC rule by the presumptive approach ([5.6.8 The Presumptive Approach](#)). MS4 permittees have the option of applying the Stormwater Management Programs (SWMPs) that comply with the MS4 Permit to the areas served by their municipal UIC wells pursuant to [WAC 173-218-090](#) (1)(c)(C) in the manner described below. Municipalities not covered by the MS4 Permit may follow a similar approach. Note that the MS4 Permit does not require jurisdictions to fulfill all the requirements of the UIC program.

Municipalities may fulfill the source control and operation and maintenance requirements for new and existing municipal UIC wells under the following conditions:

- All areas served by municipally owned and operated UIC wells must be included in a Stormwater Management Program (SWMP) that ensures appropriate siting, treatment, design, operation, and maintenance of new municipal UIC wells as well as source control activities (including targeted education and outreach) that are well-suited for the land uses in these areas.
  - MS4 permittees may have a combined SWMP that addresses UIC and NPDES permit requirements together, or they may have two separate SWMPs for the areas served respectively by their municipal UIC wells and by their MS4.
  - In areas not covered by the MS4 permit, municipalities may create a SWMP specifically for the areas served by municipal UIC wells.
- To comply with the UIC rule, jurisdictions must implement all of the following activities and include them in their SWMP:

- Register all UIC wells, including existing and new wells.
- Design, construct, operate, and maintain new UIC wells according to the specifications throughout [5.6 Subsurface Infiltration \(Underground Injection Control Wells\)](#).
- Operate and maintain existing wells according to the specifications throughout [5.6 Subsurface Infiltration \(Underground Injection Control Wells\)](#).

Municipalities choosing not to develop and implement a SWMP in areas served by existing Class V UIC wells must:

- Conduct a well assessment ([5.6.5 Well Assessment](#)) for each existing UIC well, and
- Create a Stormwater Site Plan (SSP) for the area served by each existing municipal UIC well. The SSP will include source control best management practices applicable to the activities present in the area and describe operation and maintenance procedures to keep the UIC well functioning properly to provide necessary treatment to protect groundwater.

All new municipal UIC wells must be sited, designed, constructed, managed, operated, and maintained according to the requirements throughout [5.6 Subsurface Infiltration \(Underground Injection Control Wells\)](#).

### **5.6.5 Well Assessment**

The assessment of an existing UIC well evaluates the potential risks to ground water from the use of the well and includes information such as:

- The land use and activities around the well (which affect the quality of the discharge),
- The local geology,
- Depth of the ground water table in relation to the UIC well, and
- Whether the UIC well is located in a ground water protection area.

Use this information to assess whether the well is a high threat to ground water quality, by applying the information in [5.6.16 Determining Treatment Requirements](#) and [5.6.17 Classification of Vadose Zone Treatment Capacity](#). If an existing UIC well is located in a ground water protection area and the assessment determines that sufficient best management practices are not provided under the current conditions, retrofitting is required to protect ground water quality. Existing UIC wells in ground water protection areas that receive prohibited discharges ([5.6.12 Prohibitions](#)) must either be decommissioned or the activities must be moved and separated from the areas served by the existing UIC well.

A UIC well that was in use prior to the project is considered an existing well only if it remains in place. The well may be retrofitted or reconstructed in place without being considered a new well. Otherwise, if an existing well is moved, it is considered a new well, and the UIC requirements pertaining to new UIC wells apply.

## **Evaluating High Threat to Ground Water**

For existing UIC wells, Ecology considers any of the following a high threat to ground water for which the UIC well must be retrofitted.

- Existing UIC wells receiving prohibited discharges ([5.6.12 Prohibitions](#)); these wells also require a separate groundwater discharge permit.
- Existing UIC wells receiving a high pollutant load where the vadose zone between the bottom of the UIC well and the top of the ground water has no treatment capacity or the vadose zone conditions are unknown; retrofits must provide treatment prior to the discharge to the well.
- Existing UIC well structures completed below the ground water table; retrofits must provide separation and, if needed ([5.6.16 Determining Treatment Requirements](#) and [5.6.17 Classification of Vadose Zone Treatment Capacity](#)), treatment. (If a UIC well has standing water when it has not received recent stormwater inflows, it is likely completed below the ground water table. See [WAC 173-218-090\(1\)\(b\)](#) for separation requirements between the bottom of the UIC well and the top of the ground water table.)
- Site-specific information indicates that a ground water quality problem exists in the vicinity of the existing UIC well.

A UIC well retrofit means to reduce the pollutant load from a UIC well to meet the nonendangerment standard by applying source control activity and/or structural controls such as a treatment BMP or create separation between the base of the well and the top of the groundwater table, [WAC 173-218-030](#).

### **5.6.6 Preservation and Maintenance Projects**

A preservation or maintenance project is defined as preserving/protecting infrastructure by rehabilitating or replacing existing structures to maintain operational and structural integrity, and for the safe and efficient operation of the UIC well. Maintenance projects do not increase the traffic capacity of a roadway or parking area.

A UIC well that was in use prior to a preservation or maintenance project is considered an existing well only if it remains in place. The well may be retrofitted or reconstructed in place without being considered a new well. Otherwise, if an existing UIC well is moved, it is considered a new well and the UIC requirements apply pertaining to new UIC wells apply.

### **5.6.7 Emergency Situations**

In emergency situations, such as roadway flooding, a jurisdiction may install a UIC well that does not meet the requirements in this manual on a temporary basis. When weather permits, and within a year of the event, the jurisdiction must either fully decommission the well or ensure that the UIC well meets the requirements of the rule.

For example, excessive winter rainfall overwhelms the capacity of the existing drainage system along a road. The water drains onto the road and turns to ice. The jurisdiction installs a new UIC well to fix the immediate problem and, once the weather permits, implements the required runoff treatment BMPs.

## 5.6.8 The Presumptive Approach

New UIC wells that meet all of the requirements detailed throughout [5.6 Subsurface Infiltration \(Underground Injection Control Wells\)](#) meet the presumptive approach to comply with the non-endangerment standard. Otherwise, the demonstrative approach ([5.6.9 The Demonstrative Approach](#)) is required.

The presumptive approach requires the implementation of BMPs in [Chapter 5 - Runoff Treatment BMP Design](#), [Chapter 6 - Flow Control BMP Design](#), and/or [Chapter 8 - Source Control](#) of this manual or an equivalent manual, adopted at the time of construction. The manual addresses the following issues:

- The potential pollutant loading expected in the stormwater runoff for the planned land use(s) (see [5.6.17 Classification of Vadose Zone Treatment Capacity](#))
- Source control of pollutants, especially those that are difficult to remove from stormwater by filtration, settlement, or other treatment technologies (see [Chapter 8 - Source Control](#))
- Known treatment methods (see other sections of [Chapter 5 - Runoff Treatment BMP Design](#))
- The potential treatment capacity of the vadose zone (see [5.6.16 Determining Treatment Requirements](#))
- Siting (see the Site Suitability Criteria [SSC] in [5.4.3 General Criteria for Infiltration and Bioinfiltration BMPs](#))
- Design (see [5.6.10 Siting and Design of New UIC Wells](#) or [6.3.6 BMPs for Infiltration](#))
- Operation and maintenance (O&M) (see [Appendix 6-A: Recommended Maintenance Criteria for Flow Control BMPs](#))

[5.6.10 Siting and Design of New UIC Wells](#) details the siting and design criteria to meet the presumptive approach for drywells designed to meet runoff treatment. [6.3.6 BMPs for Infiltration](#) details the design requirements for infiltration trenches and drywells.

The presumptive approach may not be used when none of the source control or treatment BMPs in the manual are expected to eliminate or reduce concentrations of the pollutant(s) of concern ([WAC 173-218-090\(1\)\(i\)\(D\)](#)) to meet the nonendangerment standard.

## 5.6.9 The Demonstrative Approach

New UIC wells must meet the demonstrative approach to meet the non-endangerment standard if the presumptive approach is not completely followed, or if for any reason a project proponent chooses not to directly apply all of the requirements of this manual (or an equivalent manual).

The documentation for the demonstrative approach is a site-specific analysis that demonstrates that the proposed discharge will comply with ground water quality standards.

To be eligible for rule-authorization using the demonstrative approach, the following topic areas must be addressed and documented with the UIC well registration:

- Site-specific analysis of pollutant loading
- Site-specific analysis of the treatment capacity of the vadose zone, if used for treatment
- BMP selection process used
- Pollutant removal expected from the selected BMPs
- Technical basis supporting the performance claims for the selected BMPs
- Assessment of how the selected BMPs will comply with state ground water quality standards and satisfy state all known, available, and reasonable methods of prevention, control, and treatment (AKART) requirements

### **5.6.10 Siting and Design of New UIC Wells**

The requirements in this section apply to UIC wells built on or after February 3, 2006.

#### ***Minimum Siting Requirements for Rule-Authorization of New UIC Wells***

The following Site Suitability Criteria (SSC) from [5.4.3 General Criteria for Infiltration and Bioinfiltration BMPs](#) apply to all UIC wells:

- [SSC-1: Setback Criteria](#)
- [SSC-2: Ground Water Protection Areas](#)
- [SSC-3: High Vehicle Traffic Areas](#)
- [SSC-5: Depth to Bedrock, Ground Water Table, or Impermeable Layer](#)
- [SSC-7: Seepage Analysis and Control](#)
- [SSC-8: Cold Climate and Impact of Roadway Deicing Chemicals](#)
- [SSC-9: Previously Contaminated Soils or Unstable Soils](#)

UIC wells may be used to provide flow control for stormwater runoff where pollutant concentrations that reach ground water will meet the Washington State ground water quality standards in the following situations:

- For flows greater than the water quality design storm (see [Chapter 4 - Hydrologic Analysis and Design](#)); or
- Where stormwater is treated prior to discharge into the UIC well according to the requirements in [5.6.16 Determining Treatment Requirements](#).

Furthermore, if [SSC-4: Soil Infiltration Rate/Drawdown Time](#) and [SSC-6: Soil Physical and Chemical Suitability for Treatment](#) are met, the site is considered to have a high treatment capacity, and the existing site soils may be used to provide runoff treatment for flows through the UIC well (see [5.6.13 Source Control and Runoff Treatment Requirements](#)).

#### **Restrictions on Siting UIC Wells**

- Prohibited areas: A UIC well may not be sited in prohibited areas; see [5.6.12 Prohibitions](#) for the list of areas where stormwater discharges to UIC wells are prohibited.
- Soil contamination: UIC wells may not be sited where there are soil contaminants that could be transported to ground water unless the site is remediated prior to construction.

### **Siting UIC Wells Near Drinking Water Wells**

Because a UIC well could be a potential source of contamination, it must be sited  $\geq 100$  feet from a drinking water well, outside of the sanitary control area of a public drinking water system, and  $\geq 200$  feet from a spring used for drinking water supplies. The design must consider the distance between the UIC well and a drinking water well based on the direction and rate of ground water flow, and the vulnerability of the drinking water supply well to potential contamination, which is influenced by the following factors:

- Depth/distance from the bottom of the UIC well to the drinking water well screened interval(s), and
- Presence or lack of confining layer(s) between the bottom of the UIC well and the aquifer interval(s) used as the water supply, and
- Characteristics of the geologic material between the bottom of the UIC well and the aquifer.

### **Ground Water Protection Areas**

At a minimum, basic treatment to remove solids prior to discharge to the UIC well is required for UIC wells located:

- In a wellhead protection area where the drinking water well is categorized with a high-susceptibility rating by the Washington State Department of Health, and/or
- Where a confining layer is not present between the base of the UIC well and the top of the aquifer used as a drinking water source, except when a UIC well receives insignificant and or low pollutant load from stormwater (see [Table 5.22: Pollutant Loading Classifications for Solids, Metals, and Oil in Stormwater Runoff Directed to UIC Wells](#)).

Local jurisdictions may have ordinances that apply to development within ground water protection areas, such as sole source aquifers, ground water management areas, wellhead protection areas, and areas designated as Critical Aquifer Recharge Areas. To locate the wellhead areas and the associated water districts in each county, see the Washington State Department of Health (DOH) Source Water Assessment Program maps at the following web address:

<https://fortress.wa.gov/doh/swap/>

Consult with the local jurisdiction for information on ground water protection areas.

## ***Design and Construction Requirements for Rule-Authorization of New UIC Wells***

In order to be rule-authorized under the presumptive approach, UIC wells must be designed and installed in accordance with this manual or an equivalent manual adopted at the time of construction.

The following subsections include additional requirements for design and construction of UIC wells.

### **Prevention of Clogging During Construction**

In order to prevent clogging, UIC wells must be protected from sediment in runoff generated during construction. See [Chapter 7 - Construction Stormwater Pollution Prevention](#) for construction BMPs to prevent other pollutants from entering the UIC well during the construction phase of a project.

### **Stormwater Infiltration Rate/Drawdown Time**

In most cases, UIC wells are designed to completely drain ponded runoff within 48 to 72 hours after flow to the UIC well has stopped. If the UIC well is designed to meet a runoff treatment requirement, the long-term infiltration rate (see [6.3.3 General Criteria for Infiltration BMPs](#)) must be sufficient to accommodate the water quality design storm (see [Chapter 4 - Hydrologic Analysis and Design](#)).

### **Vertical Separation for Rule-Authorization Using the Presumptive Approach**

[WAC 173-218-090](#) requires that new Class V UIC wells used for stormwater management must not directly discharge into ground water. A 5-foot separation between the bottom of the well and the top of the ground water is required, unless a demonstrative approach confirms that a separation of 3 feet will meet the non-endangerment standard.

The required depth to ground water/vertical separation between the base of the UIC well and the top of the ground water table for rule-authorization using the presumptive approach depends on the treatment capacity of the unsaturated zone. [5.6.16 Determining Treatment Requirements](#) and [5.6.17 Classification of Vadose Zone Treatment Capacity](#) provide a method for determining the treatment requirements based on the treatment capacity of the vadose zone and the pollutant loading classification of the stormwater runoff directed to the UIC wells.

The minimum vertical separation is 5 feet between the base of a UIC well and the highest elevation between the seasonal high ground water table, bedrock, hardpan, or other low-permeability layer.

### **Vertical Separation When 5-Foot Minimum Separation Cannot Be Met**

If the vertical separation required for the presumptive approach cannot be met:

- Rule-authorization can be obtained using the demonstrative approach (see [5.6.9 The Demonstrative Approach](#)), or
- A reduction in separation to as little as 3 feet can be considered under the presumptive approach provided:
  - The treatment requirements are otherwise met (see [5.6.16 Determining Treatment Requirements](#) and [5.6.17 Classification of Vadose Zone Treatment Capacity](#)), and:
  - The ground water mounding analysis, the volumetric water holding capacity of the zone receiving the water, and the design of the overflow and/or bypass structures are judged by the design professional as adequate to prevent overtopping and meet the SSC specified in this section.

### **5.6.11 Operation and Maintenance of UIC Wells**

The UIC rule requires that wells are operated and maintained to protect ground water quality. Maintenance of UIC wells prevents clogging and contamination from materials that collect in the well over time. The following required preventive maintenance activities will help maintain UIC function:

- Treatment for solids removal or a catch basin with a down-turned elbow upstream of discharge to the UIC well to promote the long-term infiltration capacity and reduce the need for maintaining the UIC wells, as well as reduce the long-term accumulation of contaminants in the vadose zone
- Frequent inspections and regular maintenance to improve the long-term performance of UIC wells
- Periodic removal of debris and sediment from the drywell to reduce or eliminate the buildup of materials that could inhibit infiltration
- Checking for structural damage and repair as needed

See [Appendix 6-A: Recommended Maintenance Criteria for Flow Control BMPs](#) for recommended maintenance criteria and inspection frequencies.

### **5.6.12 Prohibitions**

UIC wells may not receive stormwater from the activities and conditions listed below:

- Vehicle maintenance, repair, and service
- Commercial or fleet vehicle washing
- Airport/airplane deicing
- Storage of treated lumber
- Storage or handling of hazardous materials
- Generation, storage, transfer, treatment, or disposal of hazardous wastes
- Handling of radioactive materials
- Solid waste handling facilities, including compost and biosolid facilities, except for those that recycle only glass, paper, plastic, or cardboard
- Concrete recycling facilities that generate, store, or handle crushed concrete
- Asphalt recycling facilities that generate, store, or handle crushed asphalt
- Industrial or commercial areas that have outdoor processing, handling, or storage of raw solid materials or finished products unless the facility has specific management plans for proper storage and spill prevention, control, and containment appropriate to the types of materials handled at the facility (see [Chapter 8 - Source Control](#) for information on stormwater pollution prevention plans and source control)



- Contaminated sites when the stormwater would increase the mobility of the contaminants at the site. For example, a drywell could not be used upgradient of or over the contaminant plume at a leaking underground storage tank site. The stormwater could increase the movement of the contaminants.
- Process water from the production area of an animal feeding operation.
- Land use, activity, or infiltration determined to be a significant contributor of pollutants to waters of the State or a site release of hazardous substances from historical or current activities resulting in contamination of soil, ground water, surface water, if the ground water is in direct communication with surface water, or sediment, which is prohibited under the Model Toxics Control Act ([Chapter 173-340 WAC](#)) and Sediment Management Standards ([Chapter 173-204 WAC](#)).

Because of the potential to contaminate ground water, a UIC well must be individually authorized under a waste discharge permit to receive stormwater from any areas subject to the activities listed above. Ecology does not consider conventional runoff treatment to be protective of ground water in these situations. Stormwater from areas subject to the activities listed above must be handled on-site with a closed-loop system or discharged to the sanitary sewer, if allowed by the local jurisdiction.

However, careful design of these project sites may allow UIC wells to handle some of the stormwater runoff that will be generated. Stormwater from any portions of the site or facility that do not come in contact with these activities (or the areas of the facility associated with these activities) are allowed to be discharged to a UIC well following the presumptive approach.

See [WAC 173-218-040\(5\)\(b\)](#) for a list of examples of other prohibited UIC wells.

### **5.6.13 Source Control and Runoff Treatment Requirements**

The UIC rule bases source control and runoff treatment requirements on the types and quantities of pollutants expected from the proposed land use contributing storm runoff to the UIC well.

The rule presumes a UIC well meets the non-endangerment standard and is rule-authorized if the designer follows the guidelines in this section based on the following:

- Application of source control BMPs to control loading of pollutants that are difficult to remove from stormwater by filtration, settlement, or other treatment technologies, and
- Appropriate treatment of runoff to remove pollutants, which may be achieved by either or both:
  - Application of treatment to remove pollutants before discharging stormwater into the UIC well
  - Availability of appropriate vadose zone treatment capacity to remove the solid phase of pollutants in stormwater by filtration and adsorption (see [5.6.16 Determining Treatment Requirements](#) and [5.6.17 Classification of Vadose Zone Treatment Capacity](#))

#### **Source Control**

Source control is necessary to protect ground water from pathogens, pesticides, nitrates, road salts and other anti-icing and deicing chemicals, fuel additives, and many other pollutants in urban runoff,

as well as accidental spills.

The operational and structural source control BMPs that are also required to meet the non-endangerment standard for various land uses are described in [Chapter 8 - Source Control](#) or other equivalent manuals. Targeted education and outreach may also be a necessary source control measure.

Source control BMPs can significantly reduce clogging and pollutants, especially solids, and must be used at all project sites. Protect UIC wells during the construction phase to prevent sediment from entering the UIC well. Implement the BMPs in [Chapter 7 - Construction Stormwater Pollution Prevention](#) or in an equivalent manual. Where there are no existing runoff treatment BMPs to practically address a pollutant issue and where filtration by the vadose zone cannot provide adequate removal of pollutants, owners are required to use source control BMPs to meet the non-endangerment standard. Otherwise, the discharge to the UIC well is prohibited ([WAC 173-218-090 \(1\)\(c\)\(i\)\(D\)](#)). See [5.6.12 Prohibitions](#) for prohibited discharges.

Wherever practicable, reduce the exposure of stormwater to these contaminants by one or more of the following:

- Careful attention to the product label application rates
- Targeted product use to avoid contamination of stormwater runoff
- Careful management of the storage and use of products
- Separation of areas where products are used from contributing areas that discharges to a UIC well
- Spill response planning

Contact the local jurisdiction to determine whether specific source control requirements apply to your project in addition to those methods described in this manual for the proposed land use.

## ***Runoff Treatment***

The BMPs chosen for the site must remove or reduce the target pollutants to levels that will comply with State ground water quality standards when the discharge reaches the ground water table or first comes into contact with an aquifer (see [Chapter 173-200 WAC](#)). Each BMP is designed to reduce or eliminate certain pollutants. See other sections in [Chapter 5 - Runoff Treatment BMP Design](#) for specific runoff treatment BMP design criteria.

Removing solids from stormwater runoff before it is discharged to a UIC well helps preserve infiltration rates over the long term. UIC wells used for flow control are required to have solids removed prior to discharge. Treatment for solids removal (basic treatment, see the [Glossary](#) for definition) must be designed, constructed, operated and maintained in accordance with this manual or an equivalent manual.

Designers may alternatively use the demonstrative approach ([5.6.9 The Demonstrative Approach](#)) should they wish to install a BMP that is not included in this manual.

Some pollutants may require additional treatment beyond that provided by the approved BMPs described in other sections in [Chapter 5 - Runoff Treatment BMP Design](#). The text below discusses these pollutants.

## **Bacteria**

Fecal coliform bacteria and other pathogens in stormwater come from many sources. Examples are manure fertilizers, pet waste, and animal feeding operations.

Runoff treatment BMPs are unreliable in removing fecal coliform bacteria and other pathogens from runoff. Because of this, UIC wells shall not receive direct stormwater discharges from areas or sites that generate high loadings of fecal coliform bacteria, such as animal feeding operations.

Alternatively, runoff from sites generating high loadings of bacteria and pathogens may be:

- Discharged to the sanitary sewer, if allowed by the local jurisdiction; or
- Used for crop irrigation, as long as other applicable requirements are met; or
- Directed to a bioretention, biofiltration, or bioinfiltration BMP after the nutrient budget is addressed; or
- Diverted through stormwater treatment wetlands ([BMP T5.73: Stormwater Treatment Wetland](#)) prior to discharge to a UIC well.

Municipal UIC well owners must implement appropriate source control, targeted education and outreach, and illicit discharge detection and elimination programs in areas served by their UIC wells to prevent pet wastes from contaminating stormwater and to control other sources of pathogens.

UIC wells in the vicinity of land application areas (i.e., along adjacent roadways) must be protected by appropriate buffers and berms to prevent manure-contaminated runoff from entering the UIC well. Best practices for setbacks, nutrient budgets, and timing of application must also be implemented.

Private UIC well owners must ensure that their UIC wells are appropriately protected from sources of bacterial contamination.

## **Soluble Pollutants, Pesticides, Fertilizer, and Nutrients**

Many soluble pollutants that are commonly found in stormwater (including pesticides, fertilizers, road salts, and other chemical pollutants) are very difficult to remove from stormwater. Source controls applicable to the land use and activities at the site are required to reduce the contamination of stormwater from these chemicals.

Areas such as parks, playgrounds, golf courses, public ball fields, cemeteries, and urban landscape typically use pesticides and fertilizers for landscape management. Examples of other activities that generate high nutrient loads include commercial composting, commercial animal handling areas, nurseries, and land application areas.

Pesticides include a host of chemicals with varying chemical fate and transport characteristics. Some pesticides travel to ground water more readily because they are more water soluble and less

likely to “stick” or sorb to soil particles. These pesticides need treatment by a biological treatment method, such as a biofiltration swale or constructed wetland. UIC wells that receive stormwater with pesticides that use one of these biological treatment methods are rule-authorized when they are registered, providing this technical guidance is followed.

If UIC owners wish to use a different treatment method for pesticides, they may apply to the department for rule-authorization using the demonstrative approach outlined in [5.6.9 The Demonstrative Approach](#). Nonbiological treatment systems are ineffective at removing these pollutants from runoff. Instead, runoff from these types of landscaped areas should be directed to bioretention, biofiltration, or bioinfiltration systems or constructed wetlands prior to discharge to UIC wells. Stormwater with fertilizer or nutrients may be used to irrigate crops and/or landscaped areas in accordance with other applicable requirements.

Ecology encourages use of the following practices:

- Limited use of applied chemicals
- Site design to minimize runoff from the landscaped surface
- Development of a pesticide management plan

UIC wells in the vicinity of land application areas (i.e., along adjacent roadways) must be protected by appropriate buffers and berms to prevent manure-contaminated runoff from entering the UIC well. Best practices for setbacks, nutrient budgets, and timing of application must also be implemented.

### **Industrial Activities with Requirements to Monitor for Nitrate, Nitrite, Ammonia, or Phosphorus**

The U.S. EPA lists industrial activities that have monitoring requirements for nitrate, nitrite, ammonia, or phosphorus. Runoff from sites where nitrate, nitrite, ammonia, or phosphorus come into contact with stormwater must be directed to one of the following:

- Bioretention, biofiltration, or bioinfiltration systems
- Constructed wetlands prior to discharge
- Sanitary sewer, if allowed by the local jurisdiction
- Municipal drainage system that discharges to surface water, if allowed by the local jurisdiction and following treatment for removal of solids

Facilities may complete a no exposure certification as part of Ecology’s UIC well registration process for exemption from these requirements. In order to qualify, no outdoor processing, handling, or storage of raw solid materials or finished products may take place at the facility. Industrial facilities that qualify for no-exposure certification may use the Tables in [5.6.17 Classification of Vadose Zone Treatment Capacity](#) to determine treatment requirements.

### **Commercial Site Roofs With Ventilation for Commercial Indoor Pollutants**

Roof runoff from commercial businesses with ventilation systems specifically designed to remove commercial indoor pollutants must be evaluated on a case-by-case basis to identify the pollutants of concern and the appropriate treatment requirements.

In general, this runoff may be classified as a “medium” pollutant loading source (see [Table 5.22: Pollutant Loading Classifications for Solids, Metals, and Oil in Stormwater Runoff Directed to UIC Wells](#)), and the requirements of this section may be applied to discharges from these areas to UIC wells.

### **Commercial Site Outdoor Handling or Storage**

Treatment for solids removal (basic treatment) is required at commercial sites with outdoor handling or storage of raw solid materials. Examples include gravel, sands, logs, salts, and compost.

### **Industrial Site Roofs**

Roof runoff from industrial facilities must be evaluated on a case-by-case basis and should be treated according to the other Best Management Practice requirements for the facility.

### **Industrial Sites Outdoor Handling or Storage**

Owners at industrial sites where outdoor processing, handling, or storage of raw solid materials or finished products, including outdoor loading areas for these materials or products, takes place must provide solids removal (basic treatment). These are sites defined by the U.S. EPA ([40 CFR 122.26 \(b\)\(14\)](#)).

## **5.6.14 Spills and Illicit Discharges**

Appropriate spill control, prevention and response measures for various land uses are described in [Chapter 8 - Source Control](#) and in equivalent manuals. The spill control requirements in [Chapter 8 - Source Control](#) apply to all stormwater discharges to UIC wells. Any spills that pose a threat to groundwater quality should be reported to Ecology. Petroleum spills that enter a UIC well must be reported to Ecology.

## **5.6.15 Deep UIC Wells**

UIC wells that extend below an upper confining layer and discharge into the underlying vadose zone are designated by Ecology as deep UIC wells. This includes drywells where drilling extends through a surficial till layer into the vadose zone below. Local jurisdictions may impose additional limits on the total depth of these UIC wells based on specific hydrologic conditions and other considerations.

Ecology recommends that project proponents explore alternative approaches to stormwater management before deciding to use a deep UIC well. Projects using deep UIC wells must provide the following:

- A hydrogeologic study that details the following, to determine if contamination could occur:
  - Consideration of potential changes to the aquifer.
  - Infiltration testing to determine mounding affects.

- Identification of the direction and rate of ground water flow.
- Evaluation of the treatment capacity of the vadose zone (see [5.6.16 Determining Treatment Requirements](#) and [5.6.17 Classification of Vadose Zone Treatment Capacity](#)).
- Determination as to whether the proposed deep UIC well is located within a ground water protection area (GWPA) such as a wellhead protection area.
- If a deep UIC well is located within a GWPA, assessment of the vulnerability of the drinking water supply source as follows:
  - Evaluate whether the introduction of stormwater will affect the quality of the ground water at the water supply well.
  - Describe the following hydrogeologic factors that may influence the vulnerability of a groundwater supply source:
    - Depth of the drinking water well screened interval in relation to the deep UIC well infiltration depth, and
    - Presence or lack of a confining layer between the land surface and the aquifer interval, and
    - Type of material between the land surface and the aquifer, and between the bottom of the deep UIC well and the aquifer.
- An operation and maintenance manual for the deep UIC wells and treatment structures that includes a schedule for their implementation.
- A list of source control BMPs that will be implemented to minimize solids entering the deep UIC well.
- Description of any additional special runoff treatment needs and site operation requirements.
- A minimum of basic treatment for all discharges to drywells to remove suspended sediments, and to prevent sediment entering the well structure and vadose zone.
- A minimum 15-foot separation between the base of the drywell and the surface of the seasonal high ground water table.
- Stabilization of the site prior to the drywells going on line to prevent sediment entering the drywells.
- A landscape management plan.
- Sealing of any impermeable layers that are penetrated during drilling, to prevent aquifer interconnection if a perched aquifer or other saturated stratum is penetrated.

A surface seal should also be included in the final completion of a deep drywell.

Ecology recommends hiring a Washington licensed well driller for construction of deep UICs. However, most UIC wells are not regulated by the Well Construction Act.

In the design phase of a deep UIC drywell proposal, the project proponent should notify the drinking water supply purveyor when the proposed UIC well will be located in a wellhead protection area, Critical Aquifer Recharge Area or a Sole Source Aquifer.

Submittal of a State Waste Discharge Permit application may be required and will be determined on a site-by-site basis following the evaluation of the UIC permit application. Ecology will notify the project proponent if this is the case.

## **5.6.16 Determining Treatment Requirements**

For all stormwater discharges to UIC wells, some form of treatment is required. Treatment may be provided by the vadose zone or by structural treatment BMPs, and depends on the geologic conditions, the land use, and activities at the project site.

Designers intending to use the presumptive approach can use the tables in [5.6.17 Classification of Vadose Zone Treatment Capacity](#) to identify the necessary level of Runoff Treatment prior to discharge to the UIC well.

Designers for industrial sites with no outdoor processing, storage, or handling of raw or finished products may use the Tables in [5.6.17 Classification of Vadose Zone Treatment Capacity](#). Designers may not use the tables in [5.6.17 Classification of Vadose Zone Treatment Capacity](#) for stormwater runoff from industrial activities, outdoor processing, storage, or handling of raw or finished products; or areas where stormwater runoff comes into contact with leachate or other prohibited discharges.

Where on-site or nearby geologic and ground water depth information is available, designers can use the tables in [5.6.17 Classification of Vadose Zone Treatment Capacity](#) to evaluate whether the presumption that a stormwater discharge from a road, commercial site, or residential site to a UIC well meets the non-endangerment standard for solids, metals, oil, grease, and polycyclic aromatic hydrocarbons (PAHs).

Used together, the tables in [5.6.17 Classification of Vadose Zone Treatment Capacity](#) identify Ecology's presumption about the extent to which the vadose zone provides sufficient treatment for a given pollutant loading classification and whether additional treatment is necessary to meet the ground water quality standards for these pollutants.

Depending on conditions, treatment may be as simple as a catch basin with a downturned elbow, or as complex as an oil and water separator followed by basic and/or metals removal. See [Table 5.23: Treatment Required for Solids, Oil, and Metals](#) for treatment requirements as a function of pollutant loading classification and vadose zone treatment capacity.

### **Exceptions Based on Site-Specific or Local Studies**

Exceptions to the tables in [5.6.17 Classification of Vadose Zone Treatment Capacity](#) may be made under any of the following circumstances:

- Local planning efforts have generated an alternative method that meets the non-endangerment standard based on local conditions. For example, local jurisdictions may choose to allow changes in the pollutant loading categories in [Table 5.22: Pollutant Loading Classifications for Solids, Metals, and Oil in Stormwater Runoff Directed to UIC Wells](#) based on source control BMPs implemented at a site.

- More detailed site-specific data are gathered by the project proponent and local permission is granted under a locally developed stormwater management program.
- The required thicknesses of the vadose zone treatment layer listed in [Table 5.21: Vadose Zone Treatment Capacity](#) may be as little as 3 feet for a high-capacity treatment matrix and 6 feet for a medium-capacity treatment matrix when all of the following requirements are met:
  - The UIC well is regulated under a local stormwater management program that satisfies the requirements in [5.6.4 Meeting the Non-Endangerment Standard](#), and local jurisdiction approves the change in minimum thicknesses.
  - The pollutant loadings are insignificant or low.
  - Reliable on-site information is available. Designers may use borehole logs within 0.25 miles of the proposed UIC well if geologic conditions are consistent.
  - Site-specific water level data justifies the minimal separation from the ground water table in cases where the 3 feet of high-capacity treatment matrix provides the entire separation between the bottom of the structure and the seasonal high ground water table.
  - Potential mounding of infiltrating stormwater above the ground water table is likely. Additional separation or treatment may be required.

### ***Vadose Zone Treatment Capacity***

In general, the vadose zone may provide adequate filtration, adsorption, and other pollutant reduction capacity to meet the non-endangerment standard for solids, metals, oil, grease, and PAHs. Designers may use the tables in [5.6.17 Classification of Vadose Zone Treatment Capacity](#) to evaluate the use of the vadose zone for treatment and to determine treatment requirements to reduce concentrations of these pollutants prior to discharge to the UIC well.

Studies of stormwater pollutant concentrations in water through and below infiltration systems show mixed results in the effectiveness of vadose zone filtration in protecting ground water quality ([U.S. EPA, 1999](#)), ([Pitt et al., 1999](#)), ([Mason et al., 1999](#)), and ([Appleyard, 1993](#)).

Designers can eliminate many of the problems documented in these studies by proper siting, design, maintenance, and use of the UIC well. Additional actions to offset problems are enhanced source control, spill prevention and response plans, and additional treatment prior to discharge to the UIC well, or prohibition of the discharge.

Studies of subsurface infiltration systems also indicate that filtered and adsorbed pollutants accumulate in the vadose zone at depths of less than a few feet below the UIC well at concentrations that may require soil cleanup activities upon decommissioning of a UIC well ([Mikkelsen et al., 1996a](#)), ([Mikkelsen et al., 1996b](#)), and ([Appleyard, 1993](#)).

Because contaminated soil removal and disposal costs can be considerable, project proponents may wish to consider including pretreatment BMPs to remove solids from stormwater runoff and avoid potential cleanup requirements following long-term use of the UIC well.



## 5.6.17 Classification of Vadose Zone Treatment Capacity

The treatment capacity of the vadose zone is classified as high, medium, low, or none. Ecology bases these classifications on minimum thickness and the characteristics of the geologic materials that make up the proposed treatment layer.

The tables include several different ways of describing the geologic materials: grain-size distribution, sand-to-fines ratio, well log lithology, geologic names, and infiltration rate, as defined in [Table 5.20: Examples of Geologic Material Descriptions](#).

**Table 5.20: Examples of Geologic Material Descriptions**

Geologic Material Description Method	Example
Grain size characteristics	Materials with median grain size < 0.125 mm
Sand-to-fines ratio	Having a sand to silt/clay ratio of < 1:1 and sand plus gravel < 50%
Well log lithology	Sandy or silty clay Silt Clayey or sandy silt Sandy loam or loamy sand Silt/clay with interbedded sand
Geologic name	This category includes geologic terms that indicate provenance, including till, hardpan, caliche, and loess
Infiltration rate	Infiltration rate of $\geq 12$ in/hr

The ability of geologic materials to filter or adsorb pollutants such as solids, oils, and metals is related to grain size, the amount of organic matter, and the presence of clays, among other factors. Native organic matter improves adsorption and filtration ([Ingloria et al., 1997](#)) but is rarely found at depths below UIC wells.

Geologic materials classified as having a high treatment capacity are fine-grained with a greater capacity to filter discharges. These materials also tend to remove pollutants by chemical reactions such as cation exchange capacity (CEC) and sorption. These may be mixtures of materials where silt and clay fill the void spaces in the matrix of the coarser materials. More compaction results in better filtration. High-capacity treatment layers must total a minimum of 5 feet between the bottom of the UIC well and the seasonal high ground water table to provide an adequate level of treatment (see [Figure 5.16: Schematic Vadose Zone Treatment Layer Example](#)).

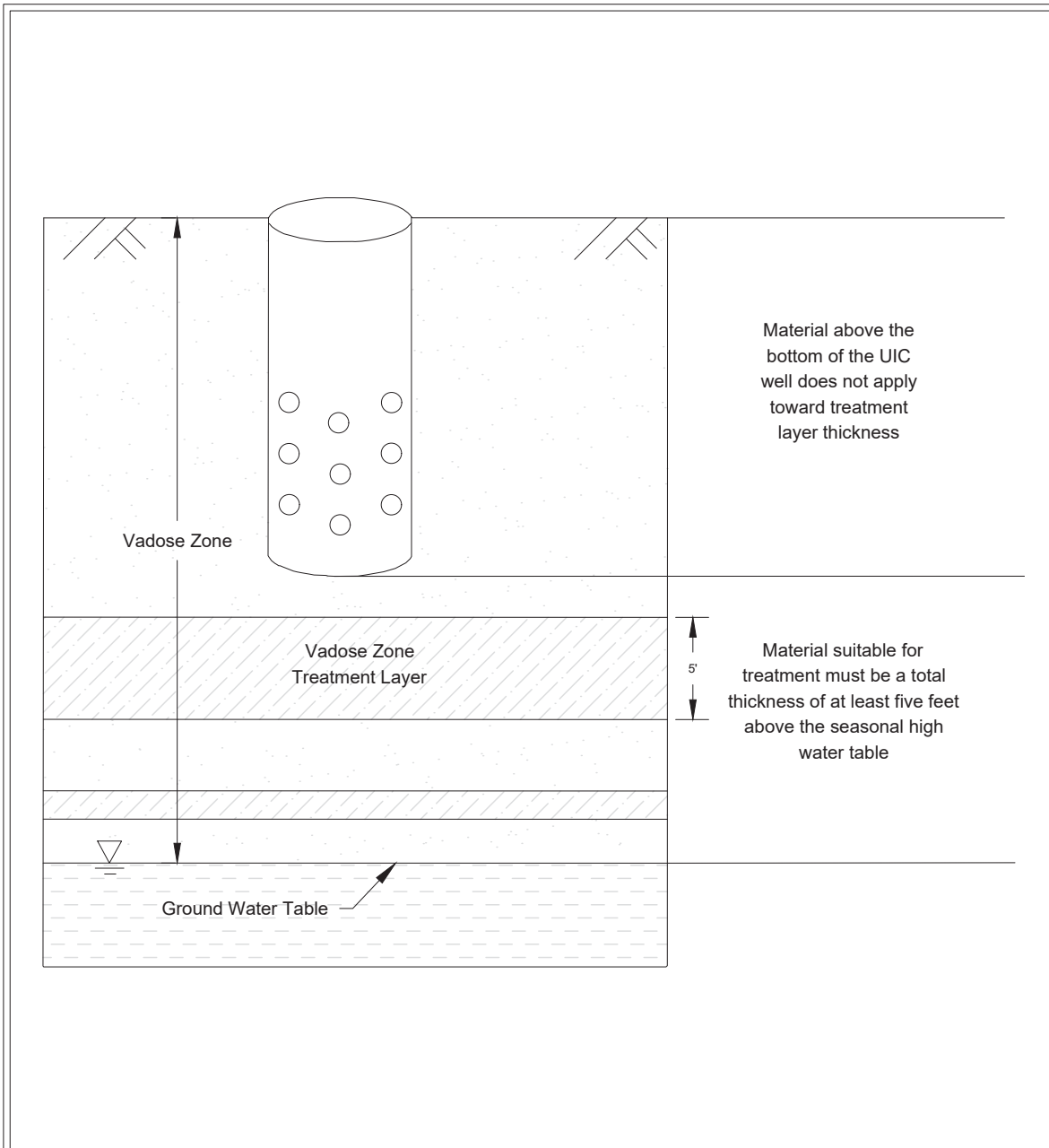
Geologic materials classified as having a medium treatment capacity provide moderate to high filtration and have minor or no chemically reactive characteristics. Medium-capacity treatment layers must total a minimum of 10 feet to provide an adequate level of treatment.

Geologic materials that have a low treatment capacity provide some minimal filtration. Although the sand and gravel mixtures in this category may provide some filtration when the UIC well is initially installed, preferential flow paths develop that contribute to relatively rapid reduction in treatment

capacity. Low-capacity treatment layers must total a minimum of 25 feet between the bottom of the UIC well and the seasonal high ground water table to provide an adequate level of treatment.

Geologic materials that are classified as having no treatment capacity do not provide filtration to remove pollutants. Since this type of material does not have treatment capacity, basic treatment of stormwater (Removal of Solids) is always required prior to discharge to the UIC well, except for sites that are classified as having an insignificant pollutant load in [Table 5.22: Pollutant Loading Classifications for Solids, Metals, and Oil in Stormwater Runoff Directed to UIC Wells](#).

**Figure 5.16: Schematic Vadose Zone Treatment Layer Example**



## Schematic Vadose Zone Treatment Layer Example

Revised December 2006

Please see <http://www.ecy.wa.gov/copyright.html> for copyright notice including permissions, limitation of liability, and disclaimer.

## ***Classification of Vadose Zone Treatment Capacity***

Site exploration or information from the site or, a site nearby, is required to obtain sufficient data to classify the treatment capacity of the vadose zone materials using [Table 5.21: Vadose Zone Treatment Capacity](#).

In some cases, geologic information may be available from regional geology maps in publications from the Washington State Department of Natural Resources or the U.S. Geological Survey, from a well borehole log(s) in the same quarter-section on Ecology's well log web page (<https://ecology.wa.gov/Regulations-Permits/Guidance-technical-assistance/Well-report-gateway>), or from local jurisdictions.

The following should be kept in mind when using these sources.

- Surface soil maps generally do not provide adequate information although the parent material information provided may be helpful in some locations.
- Verify well borehole log locations because electronic databases contain many errors of this type.
- When using borehole logs, a “nearby” site is generally defined as being within a quarter of a mile, but preferably within 50 to 500 feet of the project site, depending on the heterogeneity of the region.
- Subsurface geology can vary considerably in a very short horizontal distance in many areas of the state. Use professional judgment to determine whether the available data are adequate or site exploration is necessary.
- Alternatively, for small projects where site exploration is not cost-effective, a design professional may apply a conservative design approach, subject to the approval of the local jurisdiction.

The treatment capacity classifications in [Table 5.21: Vadose Zone Treatment Capacity](#) apply to the vadose zone between the bottom of the UIC well and the top of the highest known seasonal ground water table. Designers should use [Table 5.21: Vadose Zone Treatment Capacity](#) to assist in the determination of treatment requirements when using [Table 5.23: Treatment Required for Solids, Oil, and Metals](#). If vadose zone conditions are unknown, use “none” for treatment capacity. If thicknesses are less than the listed minimums, use “none” for treatment capacity or consider using the demonstrative approach (see [5.6.9 The Demonstrative Approach](#)). Separation between the bottom of the UIC well and the top of the ground water table is still required, see [WAC 173-218-090 \(1\)\(b\)](#).

## ***Depth to Ground Water***

The minimum required separation between the bottom of the UIC well and the highest seasonal ground water table depends on the characteristics of the vadose zone, the potential for mounding of infiltrating stormwater above the ground water table, and the degree of certainty of available data as to the seasonal high ground water table elevation.

Knowledge of the seasonal high ground water table is especially important for siting UIC wells in areas with seasonal high ground water table < 15 feet below the bottom of the UIC well.

Significant mounding of infiltrating stormwater can occur above the ground water table ([Appleyard, 1993](#)) and UIC wells must not discharge stormwater directly into ground water at any time. This applies even if the ground water level is rising in response to the UIC discharge.

In most cases, one depth to water measurement, such as water level data associated with a single borehole log, is not sufficient to determine the depth/elevation of the seasonal high ground water table. This is especially true if drilling was conducted outside of the period of seasonal high ground water levels or following a period of lower than normal precipitation. Seasonal high ground water tables generally occur during late winter through mid-spring in most of Washington State. In heavily irrigated areas, the seasonal high ground water table elevation may occur in late summer. The elevation of the seasonal high ground water table is best determined through installation and periodic monitoring of one or more ground water monitoring wells at the infiltration BMP location.

In portions of eastern Washington, ground water table elevations can fluctuate by tens of feet seasonally. At sites where the fluctuation of the seasonal ground water table is large (several feet) or unknown, designers should err on the side of caution. As described above and reinforced here, UIC wells must not discharge stormwater directly into ground water.

**Table 5.21: Vadose Zone Treatment Capacity**

Treatment Capacity Classification and Required Minimum Thickness	Description of Vadose Zone Layer <sup>c,d</sup>
<p style="text-align: center;"><b>HIGH</b></p> <p style="text-align: center;">A minimum thickness of 5 feet</p>	<p>Meets all of the following characteristics:</p> <ul style="list-style-type: none"> <li>• Materials with median grain size &lt; 0.125 mm</li> <li>• Having a sand to silt/clay ratio of &lt; 1:1 and sand plus gravel &lt; 50%</li> <li>• Field-tested saturated hydraulic conductivity below 2.4 in/hr at the bottom elevation of the proposed BMP</li> <li>• Materials with CEC of ≥ 5 milliequivalents CEC/100 g dry soils, and a minimum of 1% organic content, ≥ 18-inch minimum thickness</li> <li>• Typical geotechnical descriptive words for appropriate soils:               <ul style="list-style-type: none"> <li>◦ Lean, fat, or elastic clay</li> <li>◦ Sandy or silty clay</li> <li>◦ Silt</li> <li>◦ Clayey or sandy silt</li> <li>◦ Sandy loam or loamy sand</li> <li>◦ Silt/clay with interbedded sand</li> <li>◦ Well-compacted, poorly sorted materials</li> </ul> </li> </ul> <p><i>This category generally includes till, hardpan, caliche, and loess.</i></p>
<p style="text-align: center;"><b>MEDIUM</b></p> <p style="text-align: center;">A minimum thickness of 10 feet</p>	<p>Meets all of the following characteristics:</p> <ul style="list-style-type: none"> <li>• Materials with average grain size 0.125 to 4 mm</li> <li>• Having a sand to silt/clay ratio from 1:1 and 9:1 and percent sand &gt; percent gravel</li> <li>• Field-tested saturated hydraulic conductivity between 2.4 in/hr and 6 in/hr at the bottom elevation of the proposed BMP</li> <li>• Materials between 2 and 5 milliequivalents CEC/100 g dry soils, and a minimum of 0.5% to 1% organic content,</li> <li>• Typical geotechnical descriptive words for appropriate soils:               <ul style="list-style-type: none"> <li>◦ Fine, medium, or coarse sand</li> </ul> </li> </ul>

**Table 5.21: Vadose Zone Treatment Capacity (continued)**

Treatment Capacity Classification and Required Minimum Thickness	Description of Vadose Zone Layer <sup>c,d</sup>
	<ul style="list-style-type: none"> <li>○ Sand with interbedded clay and/or silt</li> <li>○ Poorly compacted, poorly sorted materials</li> </ul> <p><i>This category includes some alluvium and outwash deposits.</i></p>
<p style="text-align: center;"><b>LOW</b></p> <p>A minimum thickness of 25 feet</p>	<p>Meets all of the following characteristics:</p> <ul style="list-style-type: none"> <li>● Materials with median grain size &gt; 4 mm to 64 mm</li> <li>● Having a sand to silt/clay ratio &gt; 9:1 and percent sand less than percent gravel</li> <li>● Field-tested saturated hydraulic conductivity between 6 in/hr and 12 in/hr at the bottom elevation of the proposed BMP</li> <li>● Materials with CEC of ≤ 2 milliequivalents CEC/100 g dry soils and a minimum of &lt; 0.5% organic content</li> <li>● Typical geotechnical descriptive words for appropriate soils:               <ul style="list-style-type: none"> <li>○ Poorly sorted, silty, or muddy gravel</li> <li>○ Sandy gravel, gravelly sand, or sand and gravel</li> </ul> </li> </ul> <p><i>This category includes some alluvium and outwash deposits.</i></p>
<p style="text-align: center;"><b>NONE</b></p> <p>Minimum thickness not applicable</p>	<p>Meets any of the following characteristics:</p> <ul style="list-style-type: none"> <li>● Vadose zone conditions are unknown; or</li> <li>● Vadose zone conditions are known and are characterized in any of the following ways:               <ul style="list-style-type: none"> <li>○ Sedimentary materials with median grain size &gt; 64 mm</li> <li>○ Total fines (sand and mud) &lt; 5%</li> <li>○ Field-tested saturated hydraulic conductivity &gt; 12 in/hr at the bottom elevation of the proposed BMP</li> <li>○ Materials with no measurable CEC or organic content</li> <li>○ Typical geotechnical descriptive words for appropriate soils:                   <ul style="list-style-type: none"> <li>■ Well-sorted or clean gravel</li> <li>■ Boulders and/or cobbles</li> </ul> </li> </ul> </li> </ul>

**Table 5.21: Vadose Zone Treatment Capacity (continued)**

Treatment Capacity Classification and Required Minimum Thickness	Description of Vadose Zone Layer <sup>c,d</sup>
	<p style="text-align: center;">■ Fractured rock</p> <p><i>This category generally includes vadose zones with conditions that are unknown or vadose zones that are known to be composed of fractured basalt, other fractured bedrock, and cavernous limestone.</i></p>
<p>a. This table is applicable to designers intending to use the presumptive approach to identify the necessary level of stormwater treatment prior to discharge to a UIC well. Designers for industrial sites with no outdoor processing, storage, or handling of raw or finished products may also use these tables.</p> <p>b. This table is not applicable to stormwater runoff from industrial activities, outdoor processing, storage, or handling of raw or finished products; or areas where stormwater runoff comes into contact with leachate or other prohibited discharges.</p> <p>c. If vadose zone conditions are unknown or if the vadose zone thicknesses are less than those listed, use “none” for the treatment capacity.</p> <p>d. Separation between the bottom of the UIC well and the top of the ground water table is required, see <a href="#">WAC 173-218-090(1)(b)</a>.</p>	



**Table 5.22: Pollutant Loading Classifications for Solids, Metals, and Oil in Stormwater Runoff Directed to UIC Wells**

Classification	Areas Contributing Runoff to the UIC Well
Insignificant	<ul style="list-style-type: none"> <li>• Impervious surfaces not subject to motorized vehicle traffic or application of sand or deicing chemicals</li> <li>• Unmaintained open space</li> </ul>
Low	<ul style="list-style-type: none"> <li>• Parking areas with &lt; 40 total trip ends per 1,000 square feet (sf) of gross building area or &lt; 100 total trip ends (if you exceed either threshold, move to the Medium Classification)</li> <li>• Other land uses with similar traffic/use characteristics (e.g., most residential parking and employee-only parking areas for small office parks or other commercial buildings)</li> <li>• <b>Inside Urban Growth Management Areas</b> <ul style="list-style-type: none"> <li>◦ Fully controlled and partially controlled limited access highways with ADT &lt; 15,000</li> <li>◦ Other roads with ADT &lt; 7,500 vehicles</li> </ul> </li> <li>• <b>Outside Urban Growth Management Areas</b> <ul style="list-style-type: none"> <li>◦ All roads with ADT &lt; 15,000 vehicles</li> </ul> </li> </ul>
Medium	<ul style="list-style-type: none"> <li>• Parking areas with between 40 and 100 trip ends per 1,000 sf of gross building area or between 100 and 300 total trip ends (if you exceed either threshold, move to the High Classification)</li> <li>• Primary access points for high-density residential apartments</li> <li>• Intersections controlled by traffic signals that do not meet the definition of a high-density intersection (see the <a href="#">Glossary</a>)</li> <li>• Transit center bus stops</li> <li>• <b>Inside Urban Growth Management Areas</b> <ul style="list-style-type: none"> <li>◦ Fully controlled and partially controlled limited access highways with ADT between 15,000 and 30,000 vehicles</li> <li>◦ Other roads with ADT between 7,500 and 30,000 vehicles</li> </ul> </li> <li>• <b>Outside Urban Growth Management Areas</b> <ul style="list-style-type: none"> <li>◦ All roads with ADT between 15,000 and 30,000 vehicles</li> </ul> </li> </ul>
High	<ul style="list-style-type: none"> <li>• High-use sites <ul style="list-style-type: none"> <li>◦ Includes roads with ADT &gt; 30,000 vehicles</li> </ul> </li> <li>• On-street parking areas of municipal streets in commercial and industrial areas</li> </ul>

**Table 5.22: Pollutant Loading Classifications for Solids, Metals, and Oil in Stormwater Runoff Directed to UIC Wells (continued)**

Classification	Areas Contributing Runoff to the UIC Well
	<ul style="list-style-type: none"> <li>• Highway rest areas</li> <li>• Other land uses with similar traffic/use characteristics (e.g., commercial buildings with a frequent turnover of visitors, such as grocery stores, shopping malls, restaurants, drive-through services, etc.)</li> </ul>
<p>Notes:</p> <p>a. This table is applicable to designers intending to use the presumptive approach to identify the necessary level of treatment upstream of a UIC well. Designers for industrial sites with no outdoor processing, storage, or handling of raw or finished products may also use these tables.</p> <p>b. This table is not applicable to stormwater runoff from industrial activities, outdoor processing, storage, or handling of raw or finished products; or areas where stormwater runoff comes into contact with leachate or other prohibited discharges.</p>	

Use the treatment capacity classification from [Table 5.21: Vadose Zone Treatment Capacity](#) and the pollutant loading classification from [Table 5.22: Pollutant Loading Classifications for Solids, Metals, and Oil in Stormwater Runoff Directed to UIC Wells](#) to determine the appropriate level of treatment for solids, oil, and metals in [Table 5.23: Treatment Required for Solids, Oil, and Metals](#).

Designers may use UIC wells to provide flow control of excess stormwater runoff for flows greater than the water quality design storm where pollutant concentrations that reach ground water will meet Washington State ground water quality standards; or where stormwater is adequately treated prior to discharge.

**Table 5.23: Treatment Required for Solids, Oil, and Metals**

Pollutant Loading	Treatment Capacity			
	High	Medium	Low	None
<b>Insignificant</b>	Two-stage drywell <sup>a</sup>	Two-stage drywell <sup>a</sup>	Two-stage drywell <sup>a</sup>	Two-stage drywell <sup>a</sup>
<b>Low</b>	Two-stage drywell <sup>a</sup>	Pretreatment <sup>b</sup>	Pretreatment <sup>b</sup>	Remove solids <sup>c</sup>
<b>Medium</b>	Pretreatment <sup>b</sup>	Remove solids <sup>c</sup>	Remove solids <sup>c</sup>	Remove solids <sup>c</sup>
<b>High</b>	Remove oil <sup>d</sup>	Remove oil <sup>d</sup>	Remove oil and solids <sup>c,d</sup>	Remove oil and solids <sup>c,d</sup>
<p>Notes:</p> <p>a. A two-stage drywell has a catch basin or other presettling device that traps small quantities of oils and solids. Regularly inspect and maintain the catch basin or other presettling device.</p> <p>b. Pretreatment removes solids, but at a level less than basic treatment. Ecology’s definition for pretreatment is 50% removal. See the definition for pretreatment in the <a href="#">Glossary</a>.</p>				

**Table 5.23: Treatment Required for Solids, Oil, and Metals (continued)**

Pollutant Loading	Treatment Capacity			
	High	Medium	Low	None
<p>c. Treatment to remove solids means basic treatment. See the definition of basic treatment in the <a href="#">Glossary</a>. Removal of solids removes a large portion of the total metals in most stormwater runoff. Any special treatment requirements in this chapter still apply. Owners may use appropriate source control BMPs for low-pollutant-loading sites, in lieu of structural treatment BMPs.</p> <p>d. Treatment to remove oil is to be accomplished by applying one of the oil control BMPs identified in this manual. See <a href="#">BMP T5.100: API Separator Bay</a> and <a href="#">BMP T5.110: Coalescing Plate (CP) Separator Bay</a>.</p> <ul style="list-style-type: none"> <li>• At high-density intersections and at commercial or industrial sites subject to an expected average daily traffic (ADT) count of 100 vehicles/1,000 sf gross building area, sufficient quantities of oil may be generated to justify operation of a separator BMP.</li> <li>• At other high-use sites, project proponents may select a basic treatment BMP that also provides adsorptive capacity, such as a biofiltration or bioinfiltration swale, a filter, or other adsorptive technology, in lieu of a separator BMP. A catch basin with a turned down elbow is not adequate for oil control in this case.</li> <li>• For roads in eastern Washington with ADT &gt;30K, basic treatment with sorptive characteristics (i.e., swale or sand filter) is required, and suffices for the oil treatment requirement.</li> <li>• The requirement to apply a basic treatment BMP with adsorptive characteristics also applies to commercial parking and to streets with ADT &gt; 7,500.</li> </ul>				

## 5.7 Wetpool/Wetpond and Dry Pond BMPs

### 5.7.1 Purpose

Five Best Management Practices (BMPs) are described in this section:

- [BMP T5.70: Basic Wetpond](#)
- [BMP T5.71: Large Wetpond](#)
- [BMP T5.72: Wetvaults](#)
- [BMP T5.73: Stormwater Treatment Wetland](#)
- [BMP T5.74: Large Extended Detention Dry Pond](#)

The following subsections discuss the wetpond/wetpool, wetvault, stormwater treatment wetland, and dry pond components associated with these BMPs.

#### ***Wetpond/Wetpool***

A wetpond is a constructed stormwater pond that retains a permanent pool of water (“wetpool”) at least during the wet season. The volume of the wetpool is related to the effectiveness of the pond in

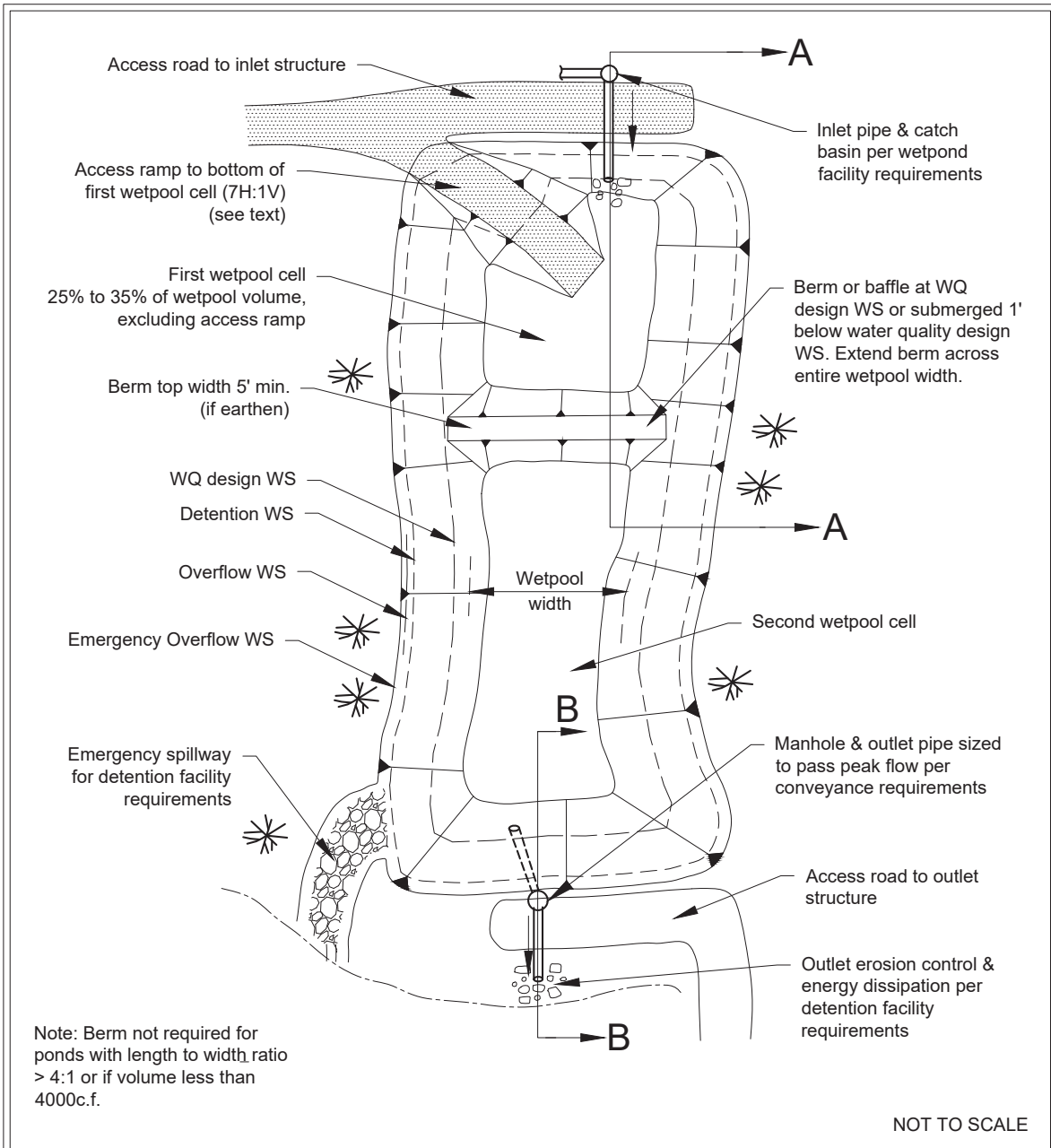
settling particulate pollutants. As an option, a shallow marsh area can be created within the permanent pool volume to provide additional treatment for nutrient removal. Peak flow control can be provided in the “live storage” area above the permanent pool. [Figure 5.17: Wetpond/Wetpool \(Plan View\)](#) and [Figure 5.17: Wetpond/Wetpool \(Plan View\)](#) illustrate a typical wet pond BMP.

A wetpool is a constructed stormwater pond or portion of BMP that retains a pool of water. In some areas the wetpool may be permanent, at least during the wet season. The volume of the wetpool is related to the effectiveness of the pond in settling particulate pollutants. As an option, a shallow marsh area can be created within the permanent pool volume to provide additional treatment for nutrient removal. Peak flow control can be provided in the “live storage” area above the permanent pool. [Figure 5.17: Wetpond/Wetpool \(Plan View\)](#) and [Figure 5.17: Wetpond/Wetpool \(Plan View\)](#) illustrate a typical wetpond BMP.

A combined detention/wetpool places a detention pond or vault on top of the wetpond or vault. The wetpond or vault is designed per this section and the detention pond or vault is designed per [6.2 Detention BMPs](#). The sediment storage area of the detention BMP can be deleted.

Underground Injection Control (UIC) regulations do not apply to these BMPs (see [5.6 Subsurface Infiltration \(Underground Injection Control Wells\)](#)).

**Figure 5.17: Wetpond/Wetpool (Plan View)**

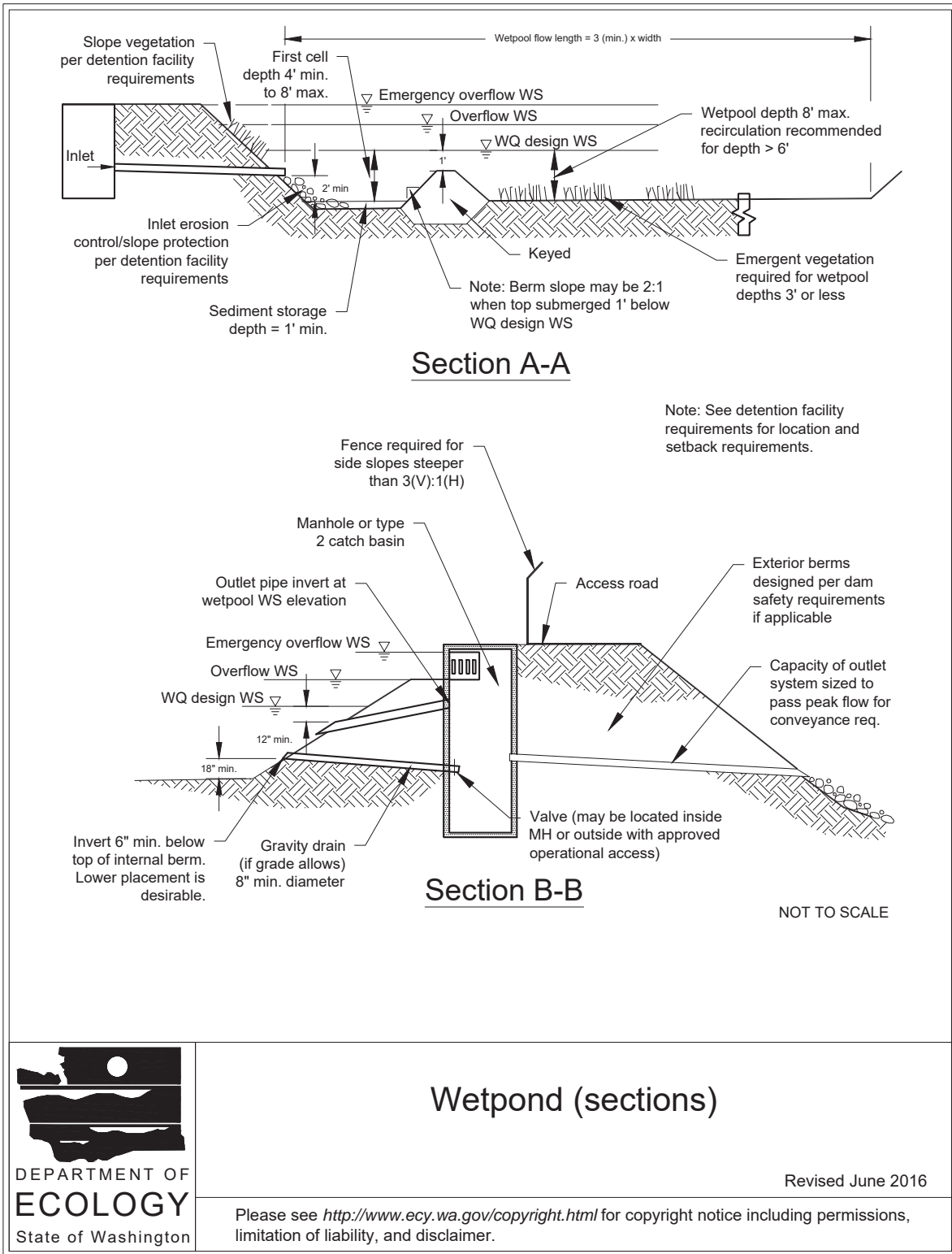


Wetpond/Wetpool (plan view)

Revised June 2016

Please see <http://www.ecy.wa.gov/copyright.html> for copyright notice including permissions, limitation of liability, and disclaimer.

**Figure 5.18: Wetpond (Sections)**



DEPARTMENT OF  
**ECOLOGY**  
State of Washington

**Wetpond (sections)**

Revised June 2016

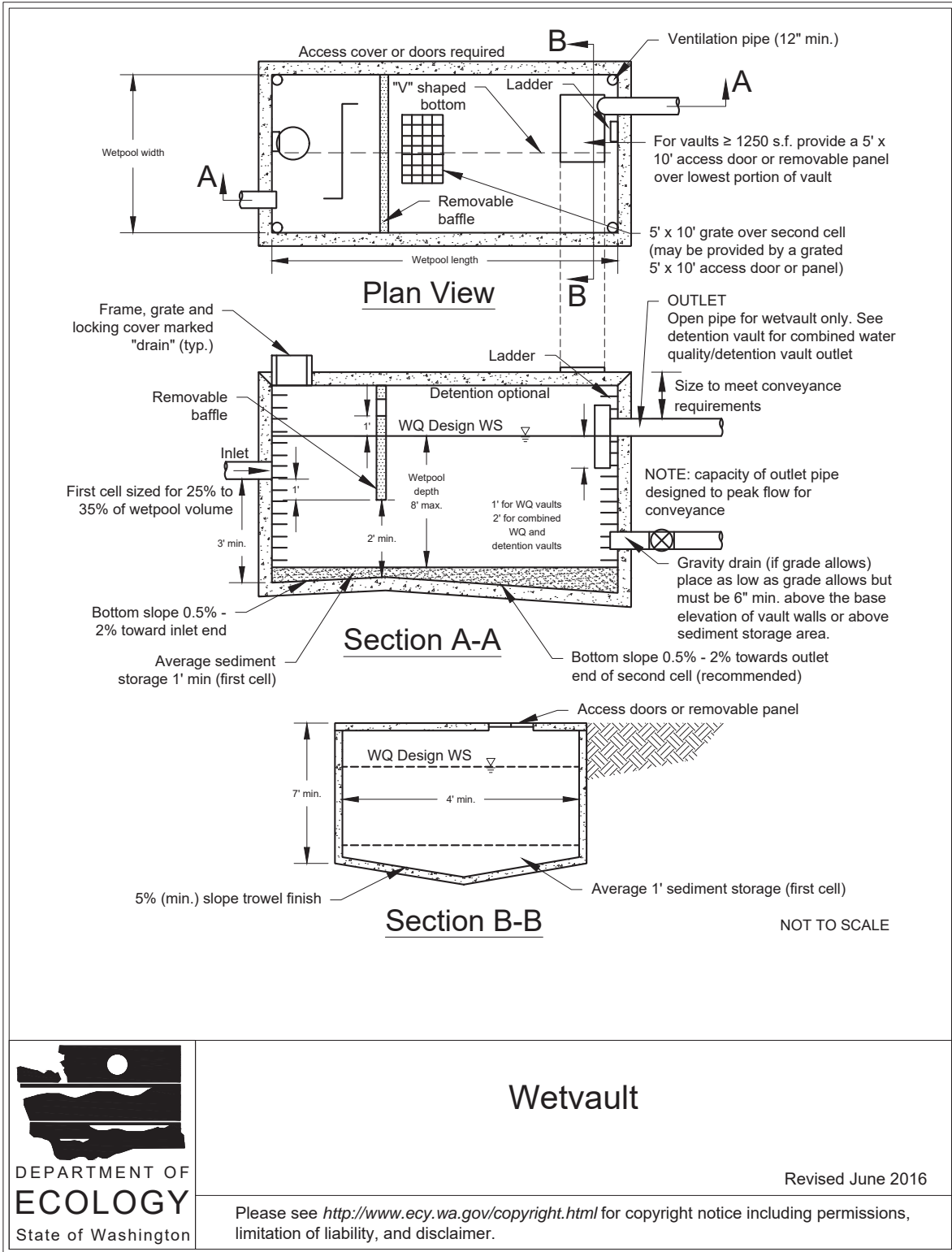
Please see <http://www.ecy.wa.gov/copyright.html> for copyright notice including permissions, limitation of liability, and disclaimer.

## **Wetvault**

A wetvault is an underground structure similar in appearance to a detention vault, except that a wetvault has a permanent pool of water (wetpool) which dissipates energy and improves the settling of particulate pollutants (see the wetvault details in [Figure 5.19: Wetvault](#)). Being underground, the wetvault lacks the biological pollutant removal mechanisms, such as algae uptake, present in large extended detention dry ponds.

UIC regulations do not apply to wetvaults if the outlet structure discharges exclusively to a conveyance system and/or to surface water. However, UIC regulations do apply to wetvaults if the outlet structure discharges into the ground, and then—provided that the design, operation, and maintenance criteria in this section are met—only the registration requirement would apply. See [5.6 Subsurface Infiltration \(Underground Injection Control Wells\)](#).

**Figure 5.19: Wetvault**



**Wetvault**

Revised June 2016

Please see <http://www.ecy.wa.gov/copyright.html> for copyright notice including permissions, limitation of liability, and disclaimer.



## ***Stormwater Treatment Wetlands***

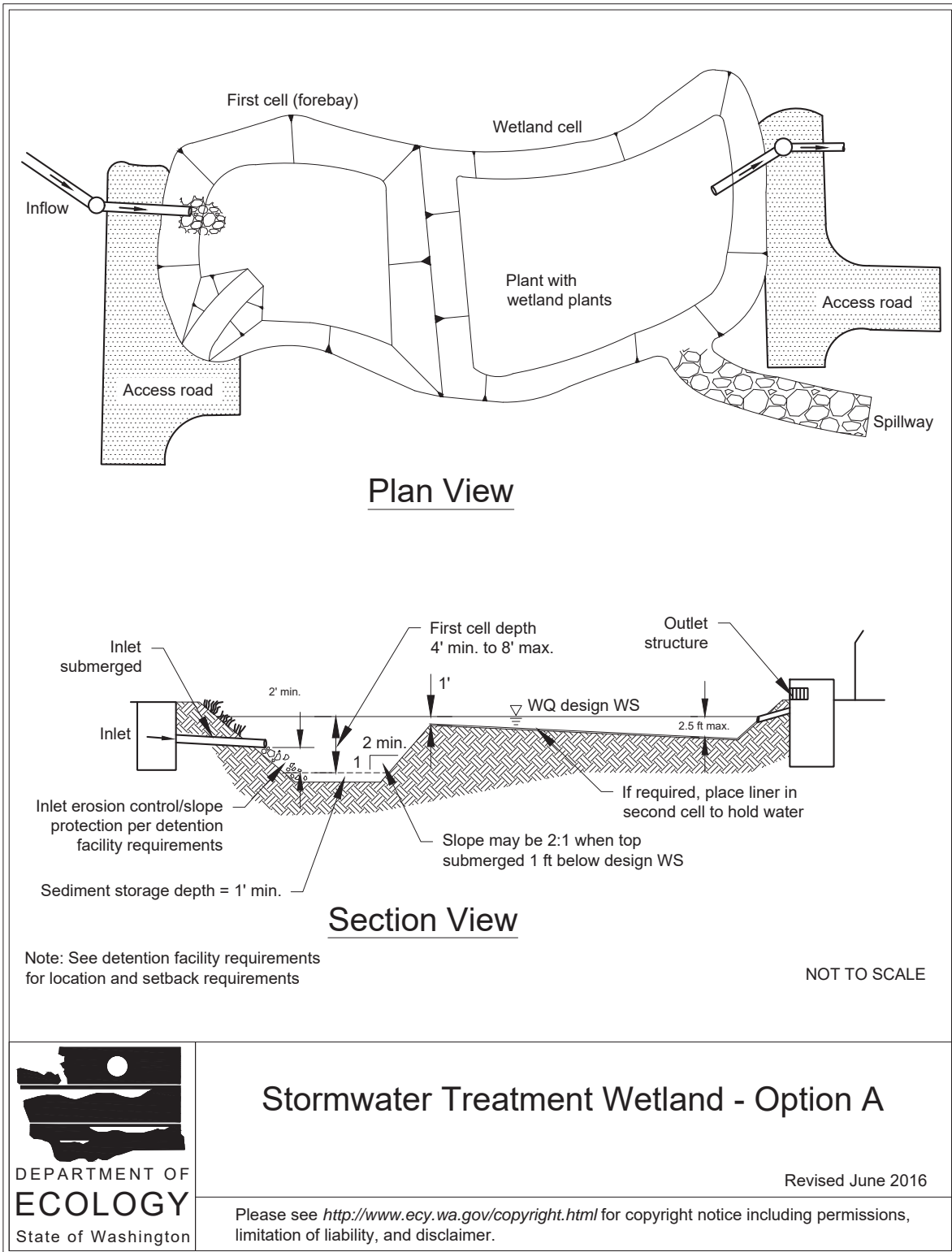
In land development situations, wetlands are usually constructed for two main reasons: to replace or mitigate impacts when natural wetlands are filled or impacted by development (mitigation wetlands), and to treat stormwater runoff (stormwater treatment wetlands). Stormwater treatment wetlands are shallow constructed ponds that are designed to treat stormwater through the biological processes associated with emergent aquatic plants (see the stormwater wetland details in [Figure 5.20: Stormwater Treatment Wetland — Option A](#) and [Figure 5.20: Stormwater Treatment Wetland — Option A](#)).

Wetlands created to mitigate disturbance impacts, such as filling, may not also be used as runoff treatment BMPs. This is because of the different, incompatible functions of the two kinds of wetlands. Mitigation wetlands are intended to function as full replacement habitat for fish and wildlife, providing the same functions and harboring the same species diversity and biotic richness as the wetlands they replace. Stormwater treatment wetlands are used to capture and transform pollutants, just as wetponds are, and over time pollutants will concentrate in the sediment. This is not a healthy environment for aquatic life. Stormwater treatment wetlands are used to capture pollutants in a managed environment so that they will not reach natural wetlands and other ecologically important habitats. In addition, vegetation must occasionally be harvested and sediment dredged in stormwater treatment wetlands, further interfering with use for wildlife habitat.

In general, stormwater wetlands perform well to remove sediment, metals, and pollutants that bind to humic or organic acids. Phosphorus removal in stormwater wetlands is highly variable.

**Note:** UIC regulations do not apply to stormwater wetlands (see [5.6 Subsurface Infiltration \(Underground Injection Control Wells\)](#)).

**Figure 5.20: Stormwater Treatment Wetland — Option A**

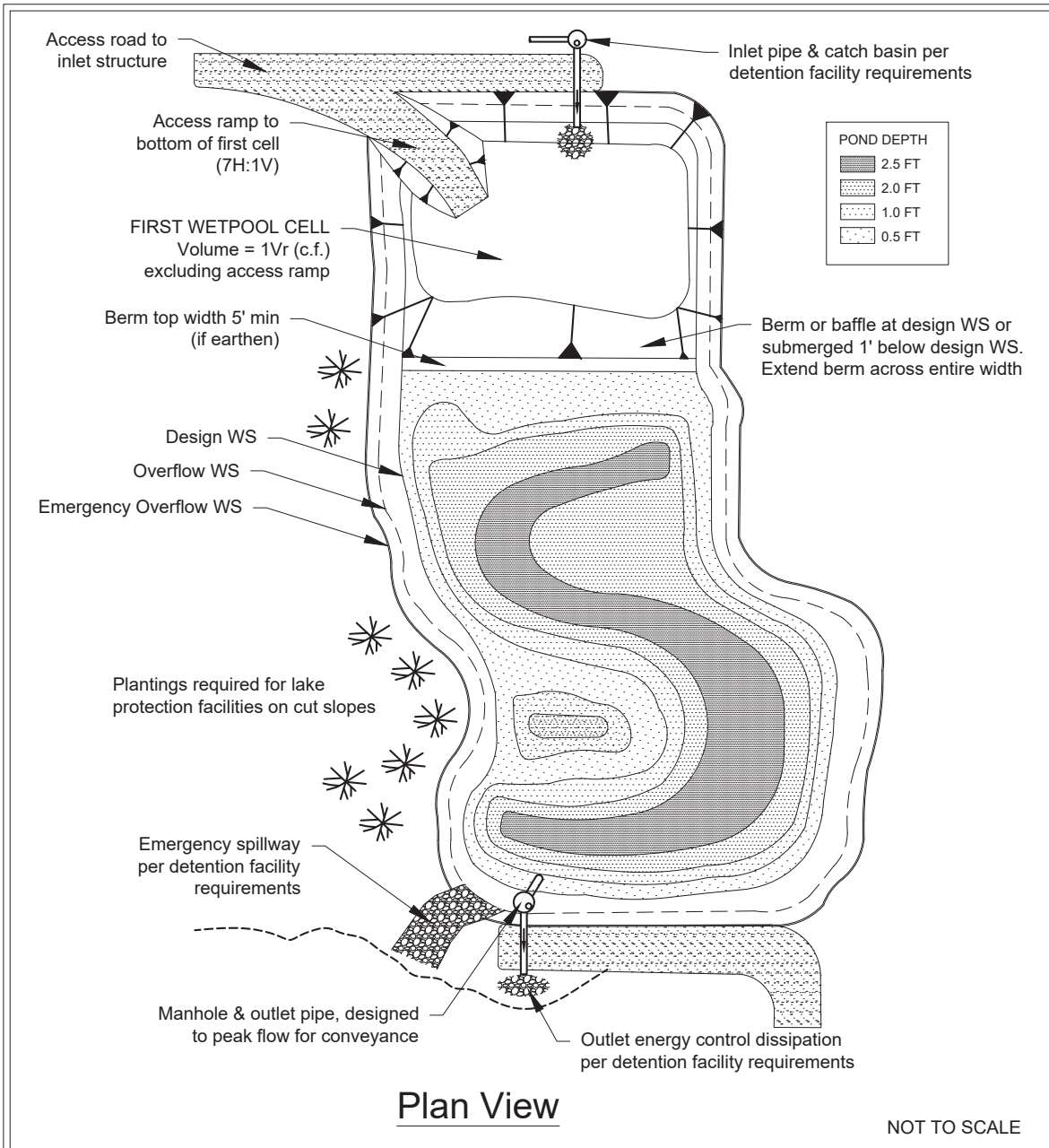


## Stormwater Treatment Wetland - Option A

Revised June 2016

Please see <http://www.ecy.wa.gov/copyright.html> for copyright notice including permissions, limitation of liability, and disclaimer.

**Figure 5.21: Stormwater Treatment Wetland — Option B**



## Stormwater Treatment Wetland - Option B

Revised June 2016

Please see <http://www.ecy.wa.gov/copyright.html> for copyright notice including permissions, limitation of liability, and disclaimer.

## **Dry Ponds**

Dry ponds are structures that completely drain between runoff events. A perforated riser or outlet control device enables water to slowly drain from the pond. Initial attempts at stormwater management involved ponds that were designed primarily for hydraulic control. Consequently, dry ponds are some of the most widely used BMPs in urban stormwater infrastructure.

With the emergence of water quality issues, the desire to designate these BMPs as dual-purpose detention BMPs is considerable. However, standard dry ponds are generally not very effective at treating water quality. One difference is that flood damage occurs as the result runoff from events having return periods > 2 years whereas environmental damage may be caused by the cumulative effects of numerous small storms. For basins with detention times < 12 hours, < 10% of the pollutants are captured ([ASCE, 1992](#)). Some studies have even produced negative results because of potential flushing of pollutants captured in previous small events ([Pope and Hess, 1989](#)). A bypass should be provided for large events.

As a way to improve water quality performance, designers have suggested that dry ponds be designed to retain stormwater for  $\geq 24$  hours. Ponds with detention times > 24 hours are referred to as large extended detention dry ponds. ([Schueler and Helfrich, 1989](#)) recommended that sufficient volume should exist to hold the runoff generated by 0.5 inches of effective rainfall.

### **5.7.2 Application**

#### **Wetpond/Wetpool**

A wetpond/wetpool requires a larger area than a biofiltration swale or a sand filter, but it can be integrated to the contours of a site fairly easily. In clayey or silty soils, the wetpond may hold a permanent pool of water that provides an attractive aesthetic feature. In more porous soils, wetponds may still be used, but water seepage from unlined cells could result in a dry pond, particularly in the summer months. Lining the first cell with a low-permeability liner is one way to deal with this situation. As long as the first cell retains a permanent pool of water, this situation will not reduce the pond's effectiveness but may be an aesthetic drawback.

Wetponds/wetpools may be single-purpose BMPs, providing only runoff treatment, or they may be combined with a detention pond to also provide flow control. If combined, the wetpool can often be stacked under the detention pond with little further loss of development area. See [Chapter 6 - Flow Control BMP Design](#) for the design of detention ponds.

Wetponds are not recommended in arid environments, as discussed further below in [5.7.4 Arid/Semiarid Climate Considerations](#).

#### **Wetvault**

A wetvault may be used for commercial, industrial, or roadway projects if there are space limitations precluding the use of other runoff treatment BMPs. The use of wetvaults for residential development is highly discouraged. Combined detention and wetvaults are allowed.

A wetvault is believed to be ineffective in removing dissolved pollutants such as soluble phosphorus or metals such as copper. There is also concern that oxygen levels will decline, especially in warm summer months, because of limited contact with air and wind. However, the extent to which this potential problem occurs has not been documented.

Below-ground structures like wetvaults are relatively difficult and expensive to maintain. The need for maintenance is often not seen and as a result, routine maintenance oftentimes does not occur.

If oil control is required for a project, a wetvault may be combined with an American Petroleum Institute (API) oil and water separator.

### Stormwater Treatment Wetlands

Stormwater wetlands typically occupy about the same surface area as wetponds, but have the potential to be better integrated aesthetically into a site because of the abundance of emergent aquatic vegetation. The most critical factor for a successful design is the provision of an adequate supply of water for most of the year. Careful planning is needed to be sure sufficient water will be retained to sustain good wetland plant growth. A source of irrigation water may be needed. Since water depths are shallower than in wetponds, water loss by evaporation is an important concern. Stormwater wetlands are a good runoff treatment BMP choice in areas with high winter ground water levels.

### Dry Ponds

As discussed further in [5.7.4 Arid/Semiarid Climate Considerations](#), large extended detention dry ponds are a preferred BMP in arid environments and may be used in semiarid environments with a dry or wet forebay.

[Table 5.24: Applicability of Wetpool/Wetpond and Dry Pond Treatment BMPs for Runoff Treatment, Flow Control, and Conveyance](#) summarizes the applicability of wetpool/wetpond and dry pond treatment BMPs for runoff treatment, flow control, and conveyance. In this table, check marks indicate that the BMP may be used on its own for the given application, and “TT” indicates that the BMP may be used as part of a treatment train for phosphorus and/or metals treatment.

**Table 5.24: Applicability of Wetpool/Wetpond and Dry Pond Treatment BMPs for Runoff Treatment, Flow Control, and Conveyance**

BMP	Runoff Treatment					Flow Control	Conveyance
	Pretreatment	Basic	Metals	Oil Control	Phosphorus		
<a href="#">BMP T5.70: Basic Wetpond</a>	✓	✓	TT <sup>a</sup>		TT <sup>a</sup>	✓ <sup>b</sup>	
<a href="#">BMP T5.71: Large Wetpond</a>	✓	✓			✓	✓ <sup>b</sup>	
<a href="#">BMP T5.72: Wetvaults</a>	✓	✓				✓ <sup>b</sup>	
<a href="#">BMP T5.73: Stormwater Treatment Wetland</a>	✓	✓	✓			✓ <sup>b</sup>	
<a href="#">BMP T5.74: Large Extended</a>	✓	✓				✓ <sup>b</sup>	

**Table 5.24: Applicability of Wetpool/Wetpond and Dry Pond Treatment BMPs for Runoff Treatment, Flow Control, and Conveyance (continued)**

BMP	Runoff Treatment					Flow Control	Conveyance
	Pretreatment	Basic	Metals	Oil Control	Phosphorus		
<a href="#">Detention Dry Pond</a>							
<sup>a</sup> BMP may be used as the first stage of a treatment train (TT) for metals and phosphorus control. <sup>b</sup> See <a href="#">Chapter 1 - Flow Control BMP Design</a> for the design of flow control BMPs.							

### 5.7.3 Cold Weather Climate Considerations

Wetpool/wetpond and dry pond treatment BMPs are generally effective in cold climates, with some modifications needed to prevent freezing of outlet pipes and selection of plants that are tolerant of cold and freezing conditions. Wetvaults should be designed with pool elevation below the frost line or per the manufacturer’s recommendation.

Because pollutant removal is by adsorption and settling, cold weather considerations regarding the changes in viscosity, and subsequently the settling velocity of particles, should be factored into the final design. See [5.2.4 Cold Weather Considerations](#) for additional cold weather considerations related to cold temperatures, deep frost line, short growing season, and/or significant snowfall.

### 5.7.4 Arid/Semiarid Climate Considerations

Large extended detention dry ponds are preferred in arid environments and may be used in semiarid environments with a dry or wet forebay.

Wetponds are not recommended in arid environments, where evaporation rates may be too high to maintain a normal pond without extensive use of scarce water. In semiarid environments, wetponds may be used with liners to help minimize water loss and with aeration to help minimize stagnation. See [Table 5.6: Recommended Stormwater Treatment BMPs Based on Climate Type](#) for additional considerations based on average annual rainfall.

For stormwater treatment wetlands, a source of irrigation water may be needed in arid/semiarid portions of eastern Washington. Since water depths are shallower than in wetponds, water loss by evaporation is an important concern and must be properly addressed in planning and design.

### 5.7.5 BMPs for Wetpools/Wetponds and Dry Ponds

#### BMP T5.70: Basic Wetpond

##### General Criteria

The primary design factor that determines the treatment efficiency of a wetpond is the volume of the wetpool. The larger the wetpool volume, the greater the potential for pollutant removal. The wetpool

volume provided shall be equal to or greater than the total volume of runoff from the water quality design storm.

Also important are the avoidance of short-circuiting and the promotion of plug flow. Plug flow describes the hypothetical condition of stormwater moving through the pond as a unit, displacing the “old” water in the pond with incoming flows. To prevent short-circuiting, water is forced to flow, to the extent practical, to all potentially available flow routes, avoiding “dead zones” and maximizing the time water stays in the pond during the active part of a storm.

Design features that encourage plug flow and avoid dead zones are the following:

- Dissipating energy at the inlet
- Providing a large length-to-width ratio
- Providing a broad surface for water exchange using a berm designed as a broad-crested weir to divide the wetpond into two cells rather than a constricted area such as a pipe
- Maximizing the flow path between inlet and outlet, including the vertical path, which also enhances treatment by increasing residence time

The following general criteria should be incorporated into the wetpond design where site conditions allow:

- The method of construction of soil/landscape systems can cause natural selection of specific plant species. Consult a soil restoration or wetland soil scientist for site-specific recommendations. The soil formulation will impact the plant species that will flourish or suffer on the site, and the formulation should be such that it encourages desired species and discourages undesired species.
- For permanent wetpool depths in excess of 6 feet, it is recommended that some form of recirculation be provided in the summer, such as a fountain or aerator, to prevent stagnation and conditions of low dissolved oxygen.
- A flow length-to-width ratio  $> 3H:1V$  minimum is desirable. If the ratio is  $\geq 4H:1V$ , then the dividing berm is not required, and the pond may consist of one cell rather than two.
- A curvilinear shape, with the inlet at the narrow end, rather than a rectangular pond is preferred since it minimizes dead zones caused by corners.
- A small amount of base flow is desirable to maintain circulation and reduce the potential for low-oxygen conditions during late summer.
- Columnar deciduous trees along the west and south sides of ponds are recommended to reduce thermal heating, except that no trees or shrubs may be planted on berms meeting the criteria of dams regulated for safety. In addition to shade, trees and shrubs also discourage waterfowl use and the attendant phosphorus enrichment problems they cause.

**Intent:** Evergreen trees or shrubs are preferred to avoid problems associated with leaf drop, except on the south and west sides, which may inhibit the melting of ice during the winter. Columnar deciduous trees (e.g., hornbeam, Lombardy poplar) typically have fewer leaves

than other deciduous trees. If the selected trees would pose a problem with leaf litter in the pond, set them back so that the branches do not extend over the pond.

- The number of inlets to the wetpond should be limited; ideally there should be only one inlet. The flow path length should be maximized from inlet to outlet for all inlets to the wetpond.
- The access and maintenance road could be extended along the full length of the wetpond and could double as play courts or picnic areas. Placing finely ground bark or other natural material over the road surface would render it more pedestrian friendly.
- Check with local jurisdiction and the Washington State Noxious Weed Control Board for an updated list of invasive species plants during plant selection.
- The following design features should be incorporated to enhance aesthetics where possible:
  - Provide side slopes that are sufficiently gentle to avoid the need for fencing (3:1 or flatter).
  - Include fountains or integrated waterfall features for privately maintained BMPs.
  - Provide visual enhancement with clusters of trees and shrubs. On most pond sites, it is important to amend the soil before planting since ponds are typically placed well below the native soil horizon in very poor soils. Make sure dam safety restrictions against planting do not apply.
  - Orient the pond length along the direction of prevailing summer winds (typically west or southwest) to enhance wind mixing.

General criteria for wetpool geometry; berms, baffles, and slopes; embankments; inlets and outlets; access and setbacks; and plantings are provided in the following subsections.

### **Wetpool Geometry**

- The wetpool should be divided into two cells separated by a baffle or berm. The first cell should contain between 25% and 35% of the total wetpool volume. The baffle or berm volume shall not count as part of the total wetpool volume. The term baffle means a vertical divider placed across the entire width of the pond, stopping short of the bottom. A berm is a vertical divider typically built up from the bottom, or if in a vault, connects all the way to the bottom.

**Intent:** The full-length berm or baffle promotes plug flow and enhances quiescence and laminar flow through as much of the entire water volume as possible. Alternative methods to the full-length berm or baffle that provide equivalent flow characteristics may be approved on a case-by-case basis by the local jurisdiction.

- Sediment storage should be provided in the first cell. The sediment storage should have a minimum depth of 1 foot. A fixed sediment depth monitor should be installed in the first cell to gauge sediment accumulation unless an alternative gauging method is proposed.
- The minimum depth of the first cell should be 4 feet, exclusive of sediment storage requirements. The depth of the first cell may be greater than the depth of the second cell.
- The maximum depth of each cell should not exceed 8 feet (exclusive of sediment storage in



the first cell). Pool depths of 3 feet or shallower (second cell) should be planted with emergent wetland vegetation.

- Inlets and outlets should be placed to maximize the flow path through the wetpool. The ratio of flow path length to width from the inlet to the outlet should be  $\geq 3:1$ . The flow path length is defined as the distance from the inlet to the outlet, as measured at mid-depth. The width at mid-depth can be calculated as follows:  $\text{width} = (\text{average top width} + \text{average bottom width}) \div 2$ .
- Wetponds with wetpool volumes  $\leq 4,000$  cubic feet (cf) may be single celled (i.e., no baffle or berm is required). However, it is especially important in this case that the flow path length be maximized. The ratio of flow path length to width should be  $\geq 4:1$  in single celled wetponds, but should preferably be 5:1.
- All inlets should enter the first cell. If there are multiple inlets, the length-to-width ratio should be based on the average flow path length for all inlets. The first cell may be lined as needed.

### **Berms, Baffles, and Slopes**

- A berm or baffle should extend across the full width of the wetpool, and tie into the wetpool side slopes. If the berm embankments are  $> 4$  feet in height, the berm must be constructed by excavating a key equal to 50% of the embankment cross-sectional height and width. This requirement may be waived if authorized by a licensed engineer in the state of Washington with geotechnical expertise based on specific site conditions. The geotechnical analysis should address situations in which one of the two cells is empty while the other remains full of water.
- The top of the berm may extend to the water quality design water surface or be 1 foot below the water quality design water surface. If at the water quality design water surface, berm side slopes should be 3H:1V. Berm side slopes may be steeper (up to 2H:1V) if the berm is submerged 1 foot.

**Intent:** Submerging the berm is intended to enhance safety by discouraging pedestrian access when side slopes are steeper than 3H:1V. An alternative to the submerged berm design is the use of barrier planting to prevent easy access to the divider berm in an unfenced wetpond.

- If good vegetation cover is not established on the berm, erosion control measures should be used to prevent erosion of the berm back slope when the pond is initially filled.
- The interior berm or baffle may be a retaining wall provided that the design is prepared and stamped by a licensed engineer in the state of Washington. If a baffle or retaining wall is used, it should be submerged 1 foot below the design water surface to discourage access by pedestrians.

### **Embankments**

Embankments that impound water must comply with the Washington State Dam Safety Regulations ([Chapter 173-175 WAC](#)). If the impoundment has a storage capacity (including both water and sediment storage volumes)  $\geq 10$  acre-feet (435,600 cf or 3.26 million gallons) above natural ground

level or has an embankment height of > 6 feet at the downstream toe, then dam safety design and review are required by the Washington State Department of Ecology. See [6.2 Detention BMPs](#) for more detail concerning detention ponds.

### **Inlet and Outlet**

See [Figure 5.17: Wetpond/Wetpool \(Plan View\)](#) and [Figure 5.18: Wetpond \(Sections\)](#) for details of the requirements discussed in this section.

- The inlet to the wetpool should be submerged with the inlet pipe invert a minimum of 2 feet from the pond bottom (not including sediment storage). The top of the inlet pipe should be submerged  $\geq 1$  foot, if possible.

**Intent:** The inlet is submerged to dissipate energy of the incoming flow. The distance from the bottom is set to minimize resuspension of settled sediments. Alternative inlet designs that accomplish these objectives are acceptable.

- An outlet structure shall be provided. Either a Type 2 catch basin with a grated opening (jail house window) or a manhole with a cone grate (birdcage) may be used. No sump is required in the outlet structure for wetponds not providing detention storage. The outlet structure receives flow from the pond outlet pipe. The grate or birdcage openings provide an overflow route should the pond outlet pipe become clogged. The overflow criteria provided below specifies the sizing and position of the grate opening.
- The pond outlet pipe (as opposed to the manhole or Type 2 catch basin outlet pipe) should be back sloped or have a turn-down elbow, and extend 1 foot below the water quality design water surface.

**Intent:** The inverted outlet pipe provides for trapping of oils and floatables in the wetpond.

**Note:** A floating outlet, set to draw water from 1 foot below the water surface, is also acceptable if vandalism concerns are adequately addressed.

- The pond outlet pipe shall be sized, at a minimum, to pass the water quality design flow.

**Note:** The highest invert of the outlet pipe sets the water quality design water surface elevation.

- The overflow criteria for single-purpose (treatment only, not combined with flow control) wetpools are as follows:

- The requirement for primary overflow is satisfied by either the grated inlet to the outlet structure or by a birdcage above the pond outlet structure.
- The bottom of the grate opening in the outlet structure should be set at or above the height needed to pass the water quality design flow through the pond outlet pipe.

**Note:** The grate invert elevation sets the overflow water surface elevation.

- In online ponds, the grated opening should be sized to pass the 100-year design flow. The capacity of the outlet system should be sized to pass the peak flow for the conveyance requirements.

- An emergency spillway shall be provided and designed according to the requirements for detention ponds (see [Chapter 6 - Flow Control BMP Design](#)).
- A gravity drain for maintenance is recommended if grade allows.

**Intent:** It is anticipated that sediment removal will be needed only for the first cell in the majority of cases. The gravity drain is intended to allow water from the first cell to be drained to the second cell when the first cell is pumped dry for cleaning.

- All metal parts should be corrosion-resistant. Galvanized materials should not be used unless unavoidable.

**Intent:** Galvanized metal contributes zinc to stormwater, sometimes in very high concentrations.

### **Access and Setbacks**

Detention ponds shall be a minimum of 20 feet from any structure, property line, and any vegetated buffer required by the local jurisdiction, and 100 feet from any septic tank/drain field.

Detention ponds shall be located away from any steep (> 15%) slope. The minimum setback from such a slope is greater than or equal to the height of the slope, unless the design professional can justify a lesser setback based on a comprehensive site evaluation. A geotechnical report must address the potential impact of a wetpond on a steep slope.

Access and maintenance roads shall be provided and designed according to the requirements for detention ponds. Access and maintenance roads shall extend to both the wetpond inlet and outlet structures. An access ramp (5H minimum:1V) shall be provided to the bottom of the first cell unless all portions of the cell can be reached and sediment loaded from the top of the pond.

If the dividing berm is also used for access, it should be built to sustain loads of up to 80,000 pounds.

### **Plantings**

If desired, the pond may be planted with dryland grasses. Sod or wetland plants should be avoided unless irrigation will be provided during the dry months. See [Appendix 5-B: Planting Recommendations](#) for planting recommendations.

### ***Design Procedure***

Procedures for determining the dimensions and volume of a wetpool are described in the following text.

1. Identify required wetpool volume using [Table 5.25: Wetpond Sizing for Basic Treatment Design](#) or the Natural Resources Conservation Service (NRCS) curve number equations presented in [Chapter 4 - Hydrologic Analysis and Design](#).

**Table 5.25: Wetpond Sizing for Basic Treatment Design**

2-Year 24-Hour Precipitation (inches)		Pond Volume per 1,000 Square Feet of Impervious Area (cubic feet)	Examples of Applicable Sites
From	To		
0.60	0.80	43.3	Moses Lake
0.81	1.00	57.1	Yakima, Kennewick
1.01	1.20	79.7	Wenatchee, Walla Walla
1.21	1.40	97.1	Colfax, Colville
1.41	> 1.41	Hydrologic Method required	Eastern and Cascade Mountains

- Determine wetpool dimensions. Determine the wetpool dimensions satisfying the design criteria outlined below and illustrated in [Figure 5.17: Wetpond/Wetpool \(Plan View\)](#) and [Figure 5.18: Wetpond \(Sections\)](#). A simple way to check the volume of each wetpool cell is to use the following equation:

**Equation 5.8: Wetpool Volume**

$$V = \frac{h (A_1 + A_2)}{2}$$

where:

V= wetpool volume (cf)

h= wetpool average depth (feet [ft])

A<sub>1</sub>= water quality design surface area of wetpool (square feet [sf])

A<sub>2</sub>= bottom area of wetpool (sf)

- Design primary overflow water surface. See [Chapter 6 - Flow Control BMP Design](#) to determine the overflow water surface for detention ponds.
- Determine wetpond dimensions. General large extended detention dry pond design criteria and concepts are shown [Figure 5.17: Wetpond/Wetpool \(Plan View\)](#) and [Figure 5.18: Wetpond \(Sections\)](#).

**Construction Criteria**

Sediment that has accumulated in the pond must be removed after construction in the contributing area of the pond is complete (unless used for a liner, as described in the following paragraph).

Sediment that has accumulated in the pond at the end of construction may be used as a liner in excessively drained soils if the sediment meets the criteria for a low-permeability liner and is

approved for use as such by a licensed engineer in the state of Washington with geotechnical expertise. Sediment used for a soil liner must be graded to provide uniform coverage and thickness.

### **Operation and Maintenance Criteria**

Maintenance is of primary importance if wetpools are to continue to function as originally designed. A local jurisdiction, a designated group such as a homeowners' association, or a property owner should accept the responsibility for maintaining the structures and the impoundment area. A specific maintenance plan should be formulated outlining the schedule and scope of maintenance operations.

Site vegetation should be trimmed as necessary to keep the pond free of leaves and to maintain the aesthetic appearance of the site. Slope areas that have become bare should be revegetated and eroded areas should be regraded prior to being revegetated.

Sediment should be removed when the 1-foot sediment zone is full plus 6 inches. Sediments should be tested for toxicants in compliance with current disposal requirements. Sediments must be disposed in accordance with current local health department requirements and the Minimum Functional Standards for Solid Waste Handling ([Chapter 173-304 WAC](#)).

Any standing water removed during the maintenance operation must be properly disposed of. The preferred disposal option is discharge to a sanitary sewer at an approved location. Other disposal options include discharge back into the wetpool or the drainage system, if approved by the operator of the drainage system.

**For more information:** See [Appendix 5-A: Recommended Maintenance Criteria for Runoff Treatment BMPs](#) for recommended maintenance criteria.

## **BMP T5.71: Large Wetpond**

For a large wetpond, increase the size of the basic wetpond by 50%. See the general criteria, design procedure, construction criteria, and operation and maintenance criteria for [BMP T5.70: Basic Wetpond](#).

## **BMP T5.72: Wetvaults**

### **General Criteria**

As with wetponds, the primary design factor that determines the removal efficiency of a wetvault is the volume of the wetpool. The larger the volume, the higher the potential for pollutant removal. Performance is also improved by avoiding dead zones (like corners) where little exchange occurs, using large length-to-width ratios, dissipating energy at the inlet, and ensuring that flow rates are uniform to the extent possible and not increased between cells.

The following design features should be incorporated into wetvaults where feasible, but they are not specifically required:

- The floor of the second cell should slope toward the outlet for ease of cleaning.
- The inlet and outlet should be at opposing corners of the vault to increase the flow path.

- A flow length-to-width ratio greater than 3:1 minimum is desirable.
- Lockable grates instead of solid manhole covers are recommended to increase air contact with the wetpool.
- Galvanized materials shall not be used unless unavoidable.
- The number of inlets to the wetvault should be limited, and the flow path length should be maximized from inlet to outlet for all inlets to the vault.

**For more information:** Typical design details and concepts for the wetvault are shown in [Figure 5.19: Wetvault](#).

### **Wetpool Geometry**

Same as specified for wetponds (see [BMP T5.70: Basic Wetpond](#) and [BMP T5.71: Large Wetpond](#)) except for the following two modifications:

- The sediment storage in the first cell shall be an average of 1 foot. Because of the V-shaped bottom, the depth of sediment storage needed above the bottom of the sidewall is roughly proportional to vault width according to the schedule in [Table 5.26: Schedule of Vault Width Versus Sediment Depth](#).

**Table 5.26: Schedule of Vault Width Versus Sediment Depth**

Vault Width (feet)	Sediment Depth (From Bottom of Sidewall) (inches)
15	10
20	9
40	6
60	4

- The second cell shall be a minimum of 3 feet deep since planting cannot be used to prevent resuspension of sediment in shallow water as it can in open ponds.

### **Vault Structure**

The vault shall be separated into two cells by a wall or a removable baffle. If a wall is used, a 5- by 10-foot removable maintenance access must be provided for both cells. If a removable baffle is used, the following criteria apply:

- The baffle shall extend from a minimum of 1 foot above the water quality design elevation to a minimum of 1 foot below the invert elevation of the inlet pipe.
- The lowest point of the baffle shall be a minimum of 2 feet from the bottom of the vault, and greater if feasible.
- If the vault is < 2,000 cubic feet (inside dimensions), or if the length-to-width ratio of the vault

pool is 5:1 or greater, the baffle or wall may be omitted and the vault may be one-celled.

- The two cells of a wetvault should not be divided into additional subcells by internal walls. If internal structural support is needed, it is preferred that post and pier construction be used to support the vault lid rather than walls. Any walls used within cells must be positioned so as to lengthen, rather than divide, the flow path.

**Intent:** Wetpool treatment effectiveness is related to the extent to which plug flow is achieved and short-circuiting and dead zones are avoided. Structural walls placed within the cells can interfere with plug flow and create significant dead zones, reducing treatment effectiveness.

- The bottom of the first cell shall be sloped toward the access opening. Slope should be between 0.5% (minimum) and 2% (maximum). The second cell may be level (longitudinally) sloped toward the outlet, with a high point between the first and second cells. The intent of sloping the bottom is to direct the sediment accumulation to the closest access point for maintenance purposes. Sloping the second cell towards the access opening for the first cell is also acceptable.
- The vault bottom shall slope laterally a minimum of 5% from each side towards the center, forming a broad “v” to facilitate sediment removal. Note: More than one “v” may be used to minimize vault depth.
- Exception: The local jurisdiction may allow the vault bottom to be flat if removable panels are provided over the entire vault. Removable panels should be at grade, have stainless steel lifting eyes, and weigh < 5 tons per panel.
- The highest point of a vault bottom must be  $\geq 6$  inches below the outlet elevation to provide for sediment storage over the entire bottom.
- Provision for passage of flows should the outlet plug shall be provided.
- Wetvaults may be constructed using arch culvert sections provided the top area at the water quality design water surface is, at a minimum, equal to that of a vault with vertical walls designed with an average depth of 6 feet.

**Intent:** To prevent decreasing the surface area available for oxygen exchange.

- Wetvaults shall conform to the “Materials” and “Structural Stability” criteria specified for detention vaults in [Chapter 6 - Flow Control BMP Design](#).
- Where pipes enter and leave the vault below the water quality design water surface elevation, they shall be sealed using a nonporous, nonshrinking grout.

### **Inlet and Outlet**

- The inlet to the wetvault shall be submerged with the inlet pipe invert a minimum of 3 feet from the vault bottom. The top of the inlet pipe should be submerged  $\geq 1$  foot, if possible.

**Intent:** The submerged inlet is to dissipate energy of the incoming flow. The distance from the bottom is to minimize resuspension of settled sediments. Alternative inlet designs that accomplish these objectives are acceptable.

- Unless designed as an off-line BMP, the capacity of the outlet pipe and available head above the outlet pipe should be designed to convey the 100-year design flow for developed site conditions without overtopping the vault. The available head above the outlet pipe must be a minimum of 6 inches.
- The outlet pipe shall be back sloped or have tee section, the lower arm of which should extend 1 foot below the water quality design water surface to provide for trapping of oils and floatables in the vault.
- The local jurisdiction may require a bypass/shutoff valve to enable the vault to be taken off-line for maintenance.

### **Access Requirements**

Same as for detention vaults (see [Chapter 6 - Flow Control BMP Design](#)) except for the following additional requirement for wetvaults:

- A minimum of 50 square feet (sf) of grate should be provided over the second cell. For vaults in which the surface area of the second cell > 1,250 sf, 4% of the top should be grated. This requirement may be met by one grate or by many smaller grates distributed over the second cell area.

**Note:** A grated access door can be used to meet this requirement.

**Intent:** The grate allows air contact with the wetpool in order to minimize stagnant conditions, which can result in oxygen depletion, especially in warm weather.

- Access roads, right-of-way, and setbacks: Same as for detention vaults ([Chapter 6 - Flow Control BMP Design](#)).

## ***Design Procedure***

### **Standard Procedure**

The standard design procedure for a wetvault is identical to the sizing procedure for a wetpond ([BMP T5.71: Large Wetpond](#) and [BMP T5.72: Wetvaults](#)). The wetpool volume for the wetvault shall be equal to or greater than the total volume of runoff from the 6-month, 24-hour storm event.

### **Modified Procedure for Combining With a Baffle Oil and Water Separator**

If the project site is a high-use site and a wetvault is proposed, the vault may be combined with a baffle oil and water separator to meet the runoff treatment requirements with one BMP rather than two. Structural modifications and added design procedures are described in the following text. The recommended maintenance criteria for baffle oil and water separators should be met, in addition to those for a wetvault. This will result in more frequent inspection and cleaning than for a wetvault used only for total suspended solids (TSS) removal. See [Appendix 5-A: Recommended Maintenance Criteria for Runoff Treatment BMPs](#) for recommended maintenance criteria.

1. The sizing procedures for the baffle oil and water separator ([5.10 Oil and Water Separator BMPs](#)) should be run as a check to ensure the vault is large enough. If the oil and water separator sizing procedures result in a larger vault size, increase the wetvault size to match.



2. An oil-retaining baffle shall be provided in the second cell near the vault outlet. The baffle should not contain a high-flow overflow, or else the retained oil will be washed out of the vault during large storms.
3. The vault shall have a minimum length-to-width ratio of 5:1.
4. The vault shall have a design water depth-to-width ratio of between 1:3 and 1:2.
5. The vault shall be watertight and shall be coated to protect from corrosion.
6. Separator vaults shall have a shutoff mechanism on the outlet pipe to prevent oil discharges during maintenance and to provide emergency shutoff capability in case of a spill. A valve box and riser shall also be provided.
7. Wetvaults used as oil and water separators must be off-line and must bypass flows greater than the water quality design flow.

**Intent:** This design minimizes the entrainment and/or emulsification of previously captured oil during very high flow events.

### **Construction Criteria**

Sediment that has accumulated in the vault must be removed after construction in the contributing area is complete. If < 12 inches of sediment have accumulated after the infrastructure is built, cleaning may be left until after building construction is complete. In general, sediment accumulation from stabilized contributing areas is not expected to exceed an average of 4 inches per year in the first cell. If sediment accumulation is > 4 inches per year, it will be assumed to be from construction unless it can be shown otherwise.

### **Operation and Maintenance Criteria**

Accumulated sediment and stagnant conditions may cause noxious gases to form and accumulate in the vault. Vault maintenance procedures must meet the Occupational Safety and Health Administration (OSHA) confined space entry requirements, which include clearly marking entrances to confined space areas. This may be accomplished by hanging a removable sign in the access riser (s), just under the access lid.

Sediment should be removed when the 1-foot sediment zone is full plus 6 inches. Sediments should be tested for toxicants in compliance with current disposal requirements. Sediments must be disposed in accordance with current local health department requirements.

Any standing water removed during the maintenance operation must be properly disposed of. The preferred disposal option is discharge to a sanitary sewer at an approved location.

See [Appendix 5-A: Recommended Maintenance Criteria for Runoff Treatment BMPs](#) for recommended maintenance criteria.

## **BMP T5.73: Stormwater Treatment Wetland**

### **General Criteria**

When used for stormwater treatment, stormwater wetlands use some of the same design features as wetponds. However, instead of gravity settling being the dominant treatment process, pollutant removal mediated by aquatic vegetation and the microbiological community associated with that vegetation becomes the dominant treatment process. Thus, when designing wetlands, water volume is not the dominant design criteria. Rather, factors that affect plant vigor and biomass are the primary concerns.

The intent of these wetland geometry criteria should be generally met. Appropriate deviations may be necessary, based on site-specific considerations:

1. Stormwater wetlands shall consist of two cells: a presettling cell and a wetland cell.
2. The presettling cell shall contain approximately 33% of the wetpool volume.
  - There is currently no single accepted method for computing volume requirements for constructed wetlands. The procedure may be left to local practice. The volume needs to include a slowly draining portion as well as a permanent pool. The slowly draining pool should release the design runoff volume over a period of  $\geq 5$  days. No more than half the volume should be released within about 2.5 days.
  - The general rule of thumb for the permanent pool is that it should provide a residence time of  $\geq 14$  days. It is not drained through an outlet but rather through evapotranspiration and infiltration. However, this is inadequate for eastern Washington due to the precipitation patterns during our summers and cold winters: a dry wetland with dead vegetation does not provide much protection during fall precipitation events, and a near-frozen pond does not promote much biological uptake of nutrients during early spring events.
  - See ([Koob et al., 1999](#)) for a statistical procedure for analyzing the time between precipitation events versus the risk of a dry pond. Local infiltration data and evapotranspiration data are essential to produce reliable estimates.
3. The depth of the presettling cell shall be between 4 feet (minimum) and 8 feet (maximum), excluding sediment storage.
4. The presettling cell shall provide 1 foot of sediment storage.
5. The permanent pool in the wetland cell shall have an average water depth of about 1.5 feet (plus or minus 3 inches). The average water depth required for the total storage volume is typically 3 feet.
6. The “berm” separating the two cells shall be shaped such that its downstream side gradually slopes to form the second shallow wetland cell (see the section view in [Figure 5.20: Stormwater Treatment Wetland — Option A](#)). Alternatively, the second cell may be graded naturalistically from the top of the dividing berm (see Criterion 8).
7. The top of berm shall be either at the water quality design water surface or submerged 1 foot

below the water quality design water surface, as with wetponds. Correspondingly, the side slopes of the berm must meet the following criteria:

- If the top of berm is at the water quality design water surface, the berm side slopes shall be no steeper than 3H:1V.
  - If the top of berm is submerged 1 foot, the upstream side slope may be up to 2H:1V. If the berm is at the water surface, then for safety reasons, its slope should not be > 3H:1V, just as the pond banks should not be > 3:1 if the pond is not fenced. A steeper slope (2H:1V rather than 3H:1V) is allowable if the berm is submerged in 1 foot of water. If submerged, the berm is not considered accessible, and the steeper slope is allowable.
8. Two examples are provided for grading the bottom of the wetland cell. One example is a shallow, evenly graded slope from the upstream to the downstream edge of the wetland cell (see [Figure 5.20: Stormwater Treatment Wetland — Option A](#)). The second example is a “naturalistic” alternative, with the specified range of depths intermixed throughout the second cell (see [Figure 5.21: Stormwater Treatment Wetland — Option B](#)). A distribution of depths shall be provided in the wetland cell depending on whether the dividing berm is at the water surface or submerged (see [Table 5.27: Distribution of Depths in Wetland Cell](#)). The maximum depth is 2.5 feet in either configuration. Other configurations within the wetland geometry constraints listed above may be approved by the local jurisdiction.
  9. A minimum length-to-width ratio of 2:1 is recommended. The shape is generally dictated by the surrounding site geometry, but the purpose of this recommendation is to prevent short-circuiting of water across the pond. Baffles, islands, and creative inlet structures can be used to promote adequate mixing in challenging settings.

**Table 5.27: Distribution of Depths in Wetland Cell**

Dividing Berm at Water Quality Design Water Surface		Dividing Berm Submerged 1 Foot	
Depth Range (feet)	Percentage	Depth Range (feet)	Percentage
0.1 to 1	25	1 to 1.5	40
1 to 2	55	1.5 to 2	40
2 to 2.5	20	2 to 2.5	20

### **Design Procedure**

1. The volume of a basic wetpond is used as a template for sizing the stormwater wetland. See [Design Procedure](#) for [BMP T5.70: Basic Wetpond](#).
2. Calculate the surface area of the stormwater wetland. The surface area of the wetland shall be the same as the top area of a wetpond sized for the same site conditions. Calculate the surface area of the stormwater wetland by using the volume from Step 1 and dividing by the average water depth (typically 3 feet).
3. Determine the surface area of the first cell of the stormwater wetland. Use the volume determined from Criterion 2 in the list of wetland geometry under [General Criteria](#) and the

actual depth of the first cell.

4. Determine the surface area of the wetland cell. Subtract the surface area of the first cell (Step 3) from the total surface area (Step 2).
5. Determine water depth distribution in the second cell. Decide if the top of the dividing berm will be at the surface or submerged (designer's choice). Adjust the distribution of water depths in the second cell according to Criterion 8 in the list of wetland geometry under [General Criteria](#).

**Note:** This will result in a wetland that holds less volume than that determined in Step 1. This is acceptable.

**Intent:** The surface area of the stormwater wetland is set to be roughly equivalent to that of a wetpond designed for the same site so as not to discourage use of this option.

6. Choose plants. See [Appendix 5-B: Planting Recommendations](#) for a list of plants recommended for wetpond water depth zones, or consult a wetland scientist.

### **Lining Requirements**

In infiltrative soils, both cells of the stormwater wetland shall be lined. To determine whether a low-permeability liner or a treatment liner is required, determine whether the following conditions will be met. If soil permeability will allow sufficient water retention, the lining requirement may be waived.

1. The second cell must retain water for  $\geq 2$  consecutive months of the year.
2. The first cell must retain  $\geq 3$  feet of water year-round.
3. A complete precipitation record shall be used when establishing these conditions. Evapotranspiration losses shall be taken into account as well as infiltration losses.

**Intent:** Many wetland plants can adapt to periods of summer drought, so a limited drought period is allowed in the second cell. This may allow a treatment liner rather than a low-permeability liner to be used for the second cell. The first cell must retain water year-round in order for the presettling function to be effective.

If a low-permeability liner is used, a minimum of 18 inches of native soil amended with good topsoil or compost (one part compost mixed with three parts native soil) must be placed over the liner. For geomembrane liners, a soil depth of 3 feet is recommended to prevent damage to the liner during planting. Hydric soils are not required.

**Note:** The criteria for impermeable liners provided in "General Criteria" for [BMP T5.80: Basic Sand Filter](#) must be observed.

### **Inlet and Outlet**

Same as for wetponds (see [BMP T5.70: Basic Wetpond](#) and [BMP T5.71: Large Wetpond](#)).

### **Access and Setbacks**

- Location of the stormwater wetland relative to site constraints (e.g., buildings, property lines) shall be the same as for detention ponds (see [Chapter 6 - Flow Control BMP Design](#)). See [5.3.4 Setbacks, Slopes, and Embankments](#) for typical setback requirements for runoff treatment BMPs.
- Access and maintenance roads shall be provided and designed according to the requirements for detention ponds (see [6.2 Detention BMPs](#)). Access and maintenance roads shall extend to both the wetland inlet and outlet structures. An access ramp (7H minimum:1V) shall be provided to the bottom of the first cell unless all portions of the cell can be reached and sediment loaded from the top of the wetland side slopes.
- If the dividing berm is also used for access, it should be built to sustain loads of up to 80,000 pounds.

### **Plantings**

The wetland cell should be planted with emergent wetland plants following the recommendations given in [Appendix 5-B: Planting Recommendations](#) or the recommendations of a wetland specialist.

**Note:** Cattails (*Typha latifolia*) are not recommended. They tend to escape to natural wetlands and crowd out other species. In addition, the shoots die back each fall and will result in oxygen depletion in the wetpool unless they are removed.

### ***Construction Criteria***

- Construction and maintenance considerations are the same as for wetponds.
- The naturalistic alternative (Option B) can be easily constructed by first excavating the entire area to the 1.5-foot average depth. Then soil subsequently excavated to form deeper areas can be deposited to raise other areas until the distribution of depths indicated in the design is achieved.

### ***Operation and Maintenance Criteria***

- Wetlands should be inspected at least twice per year during the first 3 years during both growing and nongrowing seasons to observe plant species presence, abundance, and condition; bottom contours and water depths relative to plans; and sediment, outlet, and buffer conditions.
- Maintenance should be scheduled around sensitive wildlife and vegetation seasons.
- Plants may require physical support, mulching, weed removal, or replanting during the first 3 years.
- Plants may require watering during the first 3 years or as needed during the extended dry periods.
- Nuisance plant species should be removed and desirable species should be replanted.
- The effectiveness of harvesting for nutrient control is not well documented. There are many drawbacks to harvesting, including possible damage to the wetlands and the inability to

remove nutrients in the belowground biomass. If harvesting is practiced, it should be done in the late summer.

## **BMP T5.74: Large Extended Detention Dry Pond**

The *Stormwater Management Manual for Eastern Washington* does not include detailed design criteria for large extended detention dry ponds. All proposed designs will need to be evaluated and approved by the local jurisdiction prior to implementation.

## **5.8 Filtration BMPs**

### **5.8.1 Purpose**

A typical sand filtration BMP consists of a pretreatment system, flow spreader(s), a sand bed, and the underdrain piping. The sand filter bed includes a geotextile fabric between the sand bed and the bottom underdrain system.

An impermeable liner under the BMP may also be needed if the filtered runoff requires additional treatment to remove soluble ground water pollutants, or in cases where additional ground water protection is mandated.

Five filtration Best Management Practices (BMPs) are described in this section:

- [BMP T5.80: Basic Sand Filter](#)

A sand filter basin is constructed so that its surface is at grade and open to the elements, much as an infiltration basin. However, instead of infiltrating into native soils, stormwater filters through a constructed sand bed with an underdrain system. See [Figure 5.22: Sand Filter](#) for a basic sand filter. Underground Injection Control (UIC) regulations do not apply to basic sand filters unless an underdrainage system with perforated pipe is included in the design and then—provided that the design, operation, and maintenance criteria in this section are met—only the registration requirement would apply. See [5.6 Subsurface Infiltration \(Underground Injection Control Wells\)](#).

- [BMP T5.81: Large Sand Filter](#)

A large sand filter is virtually identical to a basic sand filter except that it is sized to provide a higher level of treatment. UIC regulations do not apply to large sand filters if the outlet structure discharges exclusively to a conveyance system and/or to surface water. However, the UIC guidelines in [5.6 Subsurface Infiltration \(Underground Injection Control Wells\)](#) do apply to large sand filters if the outlet structure discharges into the ground, and then—provided that the design, operation, and maintenance criteria in this section are met—only the registration requirement would apply. See [5.6 Subsurface Infiltration \(Underground Injection Control Wells\)](#).

- [BMP T5.82: Sand Filter Vault](#)

A sand filter vault is similar to an open sand filter except that the sand layer and underdrains are installed below grade in a vault. It consists of presettling and sand filtration cells.

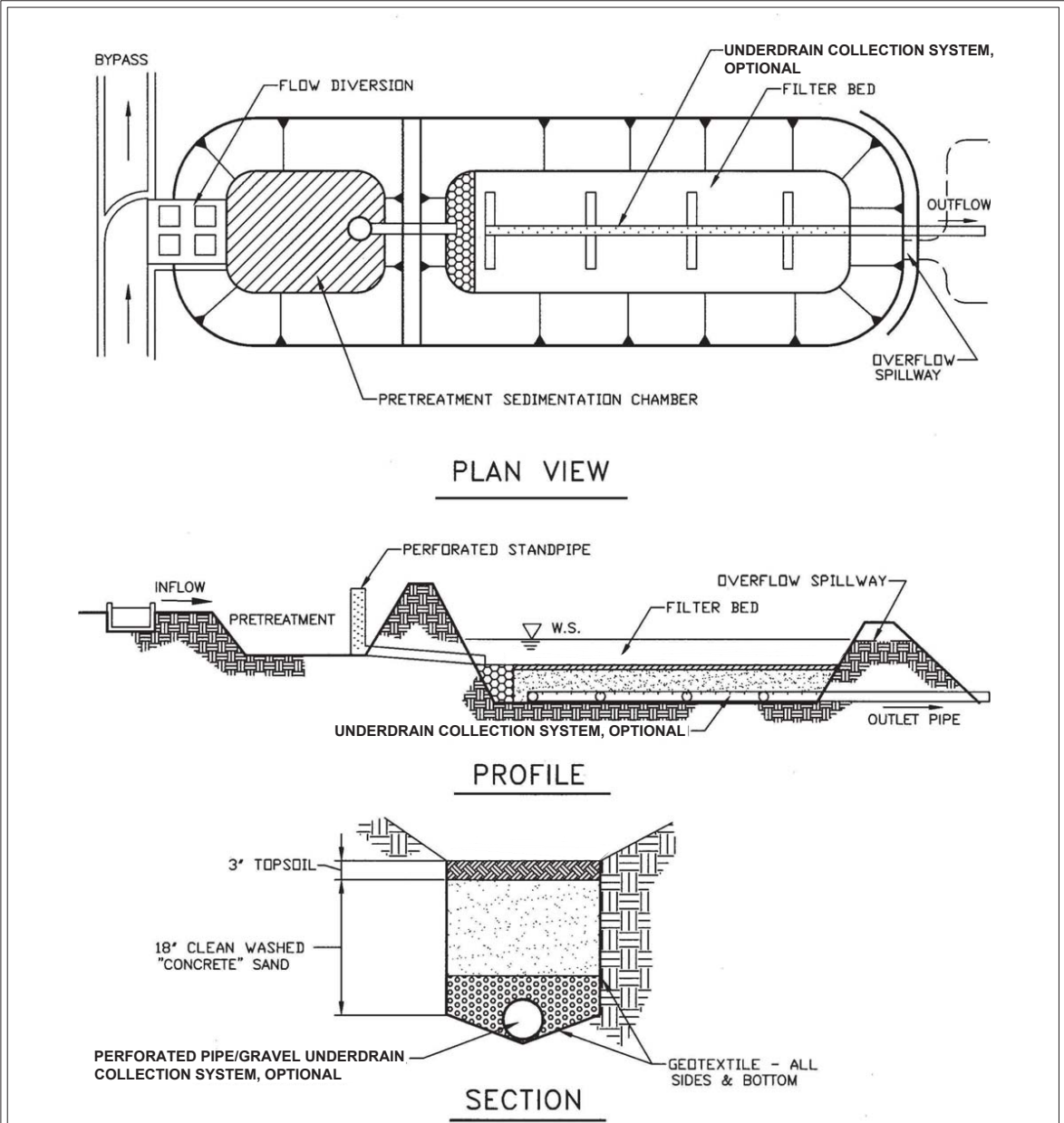
- [BMP T5.83: Linear Sand Filter](#)

Linear sand filters are typically long, shallow, two-celled, rectangular vaults. The first cell is designed for settling coarse particles, and the second cell contains the sand bed. Stormwater flows into the second cell via a weir section that also functions as a flow spreader.

- [BMP T5.84: Media Filter Drain](#) (previously referred to as Ecology Embankment)

The media filter drain (MFD) has four basic components: a gravel no-vegetation zone, a grass strip, a MFD mix bed, and a conveyance system for flows leaving the MFD mix. The MFD mix is composed of gravel, perlite, dolomite, and gypsum.

**Figure 5.22: Sand Filter**



Source: Low Impact Development Technical Guidance Manual for Puget Sound (2012)



## Sand Filter

Revised August 2018

Please see <http://www.ecy.wa.gov/copyright.html> for copyright notice including permissions, limitation of liability, and disclaimer.



## 5.8.2 Application

Sand filtration can be used in most residential, commercial, and industrial developments where debris, heavy sediment loads, and oils and greases will not clog or prematurely overload the sand, or where adequate pretreatment is provided for these pollutants. Specific applications include residential subdivisions, parking lots for commercial and industrial establishments, gas stations, high-use sites, high-density multifamily housing, roadways, and bridge decks.

Sand filters should be located off-line before or after detention. Sand filters are also suited for locations with space constraints in retrofit, and new development and redevelopment situations. Overflow or bypass structures must be carefully designed to handle the larger storms. An off-line system is sized to treat at least 90% of the annual runoff volume. If a project must comply with Core Element #6 (Flow Control), the flows bypassing the filter and the filter discharge must be routed to a retention/detention BMP or other appropriate flow control BMP (for example, infiltration BMPs such as infiltration trenches or drywells). See [Chapter 6 - Flow Control BMP Design](#) for flow control BMP design guidance.

Pretreatment is necessary to reduce velocities to the sand filter and remove debris, floatables, large particulate matter, and oils. In high water table areas adequate drainage of the sand filter may require additional engineering analysis and design considerations.

[Table 5.28: Applicability of Sand Filtration BMPs for Runoff Treatment, Flow Control, and Conveyance](#) summarizes the applicability of sand filtration BMPs for runoff treatment, flow control, and conveyance. In this table, check marks indicate that the BMP may be used on its own for the given application, “PT” indicates that a pretreatment system is needed to use the BMP for the given application, and “TT” indicates that the BMP may be used as part of a treatment train for phosphorus and/or metals treatment.

**Table 5.28: Applicability of Sand Filtration BMPs for Runoff Treatment, Flow Control, and Conveyance**

BMP	Runoff Treatment					Flow Control	Conveyance
	Pretreatment	Basic	Metals	Oil Control	Phosphorus		
<a href="#">BMP T5.80: Basic Sand Filter</a>		PT <sup>a</sup>	PT <sup>a</sup> , TT <sup>b</sup>	✓	PT <sup>a</sup> , TT <sup>b</sup>		
<a href="#">BMP T5.81: Large Sand Filter</a>		PT <sup>a</sup>	✓		✓		
<a href="#">BMP T5.82: Sand Filter Vault</a>		PT <sup>a</sup>	PT <sup>a</sup> , TT <sup>b</sup>		PT <sup>a</sup> , TT <sup>b</sup>		
<a href="#">BMP T5.83: Linear Sand Filter</a>		PT <sup>a</sup>	PT <sup>a</sup> , TT <sup>b</sup>	PT <sup>a</sup>	PT <sup>a</sup> , TT <sup>b</sup>		
<a href="#">BMP T5.84: Media Filter Drain</a>		PT <sup>a</sup>	✓		✓		
<sup>a</sup> BMP may be used for the indicated treatment type with an appropriate pretreatment (PT) system. <sup>b</sup> BMP may be used as part of a treatment train (TT) for metals and phosphorus control.							

### 5.8.3 Cold Weather Climate Considerations

Surface filters will not provide treatment in the winter if the ground is frozen, but may still provide adequate treatment during warmer months. An underground filter should be considered in areas subject to freezing conditions ([Urbonas, 1997](#)). See [5.2.4 Cold Weather Considerations](#) for additional detailed information on cold weather climate considerations.

### 5.8.4 Arid/Semiarid Climate Considerations

Sand filtration BMPs are widely used in arid/semiarid regions. A majority of the filtration BMPs described in this section are unvegetated; however, if the filtration BMP (such as the MFD) is vegetated, then grasses should be selected for drought tolerance.

## 5.8.5 BMPs for Sand Filtration

### BMP T5.80: Basic Sand Filter

Basic sand filters are expected to achieve the performance goals for basic treatment. Based on experience in King County and Austin, Texas, basic sand filters should be capable of achieving the following average pollutant removals:

- 80% total suspended solids (TSS) at influent event mean concentrations (EMCs) of 30 to 300 milligrams per liter (mg/L) ([King County, 2016](#)), ([Chang, 2000](#))
- Oil and grease to below 10 mg/L daily average and 15 mg/L at any time, with no ongoing or recurring visible sheen in the discharge

### General Criteria

The following site characteristics should be considered in siting a sand filtration system:

- Space availability, including a presettling basin
- Sufficient hydraulic head,  $\geq 4$  feet from inlet to outlet
- Average winter conditions at the project site that do not create snow or ice conditions preventing the filter from operating as designed
- Adequate operation and maintenance capability, including accessibility
- Sufficient pretreatment of oil, debris, and solids in the tributary runoff

The following additional design criteria apply to designing sand filtration systems:

- Runoff to be treated by the sand filter must be pretreated (e.g., presettling basin, depending on pollutants) to remove debris and other solids, and oil from high-use sites.
- Inlet bypass and flow spreading structures (e.g., flow spreaders, weirs or multiple orifice openings) should be designed to capture the applicable water quality design flow rate, minimize turbulence, and to spread the flow uniformly across the surface of the sand filter. Riprap or other energy dissipation devices should be installed to prevent gouging of the sand medium and to promote uniform flow. Include emergency spillway or overflow structures.
- The design criteria for the underdrain piping are provided in the following list. (Types of underdrains include a central collector pipe with lateral feeder pipes; a geotextile drain strip in an 8-inch gravel backfill or drain rock bed; or longitudinal pipes in an 8-inch gravel backfill or drain rock with a collector pipe at the outlet end.)
  - Upstream of detention underdrain piping should be sized to handle double the 2-year design storm. Downstream of detention the underdrain piping should be sized for the 2-year design storm. In both instances there should be  $\geq 1$  foot of hydraulic head above

the invert of the upstream end of the collector pipe.

- Internal diameters of underdrain pipes should be a minimum of 6 inches and two rows of 0.5-inch holes spaced 6 inches apart longitudinally (maximum), with rows 120 degrees apart (laid with holes downward). Maximum perpendicular distance between two feeder pipes must be 15 feet. All piping is to be Schedule 40 PVC or greater wall thickness. Drain piping could be installed in basin and trench configurations. Minimum underdrain size should be 8 inches in diameter if filter is subject to freezing for a month or more.
- Main collector underdrain pipe should be at a slope of 0.5% minimum (1% if subject to freezing for a month or more).
- A geotextile fabric must be used between the sand layer and drain rock or gravel and placed so that 1 inch of drain rock/gravel is above the fabric. Drain rock should be 0.75- to 1.5-inch rock or gravel backfill, washed free of clay and organic material. Increase gravel depth at base of filter to 18 inches if subject to freezing for a month or more.
- Clean-out wyes with caps or junction boxes must be provided at both ends of the collector pipes. Clean-outs must extend to the surface of the filter. A valve box must be provided for access to the clean-outs. Access for cleaning all underdrain piping should be provided. This may consist of installing clean-out ports, which tee into the underdrain system and surface above the top of the sand bed. To facilitate maintenance of the sand filter, an inlet shutoff/bypass valve is recommended.

**Note:** Other equivalent energy dissipaters can be used if needed.

- The sand in a filter must consist of a medium sand meeting the size gradation (by weight) given in [Table 5.29: Sand Media Specification](#). The contractor must obtain a grain size analysis from the supplier to certify that the No. 100 and No. 200 sieve requirements are met.

**Note:** Standard backfill for sand drains, in the latest version of the WSDOT Specifications, does not meet this specification and should not be used for sand filters.

**Table 5.29: Sand Media Specification**

U.S. Sieve Number	Percent Passing
4	95 to 100
8	70 to 100
16	40 to 90
30	25 to 75
50	2 to 25
100	< 4
200	< 2

Source: *King County Surface Water Design Manual* ([King County, 2016](#)).

- Impermeable liners for the sand bed bottom are generally required for soluble pollutants such

as metals and toxic organics and where the underflow could cause problems with structures. Impermeable liners may be clay, concrete, or geomembrane. Clay liners should have a minimum thickness of 12 inches and meet the specifications given in [Table 5.30: Clay Liner Specifications](#).

**Table 5.30: Clay Liner Specifications**

Property	Test Method	Unit	Specification
Permeability	ASTM D2434	cm/sec	1 x 10 <sup>-6</sup> max.
Plasticity Index of Clay	ASTM D423 and D424	Percent	> 15
Liquid Limit of Clay	ASTM D2216	Percent	> 30
Clay Particles Passing	ASTM D422	Percent	> 30
Clay Compaction	ASTM D2216	Percent	95% of standard Proctor density
Source: <a href="#">(City of Austin, 1988)</a> .			

If a geomembrane liner is used it should have a minimum thickness of 30 mils and be ultraviolet resistant. The geomembrane liner should be protected from puncture, tearing, and abrasion by installing geotextile fabric on the top and bottom of the geomembrane.

Concrete liners may also be used for sedimentation chambers and for sedimentation and sand filtration BMPs < 1,000 square feet (sf) in area. Concrete should be 5-inch-thick Class A or better and should be reinforced by steel wire mesh. The steel wire mesh should be 6-gauge wire or larger and 6- by 6-inch mesh or smaller. An “ordinary surface finish” is required. When the underlying soil is clay or has an unconfined compressive strength of 0.25 ton per sf or less, the concrete should have a minimum 6-inch compacted aggregate base. This base must consist of coarse sand and river rock, crushed rock, or equivalent with diameter of 0.75 to 1 inch.

If an impermeable liner is not required, then a geotextile liner should be installed that retains the sand unless the sand filter has been excavated to bedrock.

If an impermeable liner is not provided, then an analysis should be made of possible adverse effects of seepage zones on ground water, and near building foundations, basements, roads, parking lots and sloping sites. Sand filters without impermeable liners should not be built on fill sites and should be located ≥ 20 feet downslope and ≥ 100 feet upslope from building foundations.

- Include an access ramp with a slope not to exceed 7H:1V, or equivalent, for maintenance purposes at the inlet and the outlet of a surface filter. Consider an access port for inspection and maintenance.
- Side slopes for earthen/grass embankments should not exceed 3H:1V to facilitate mowing.
- High ground water may damage underground structures or affect the performance of filter underdrain systems. There should be sufficient clearance (≥ 2 feet is recommended) between the seasonal high ground water level (highest level of ground water observed) and the bottom of the sand filter to obtain adequate drainage.

- An overflow should be included in the design of the sand filter pond. The overflow height should be at the maximum hydraulic head of the pond above the sand bed.

## Design Procedure

The objective of designing a basic sand filter is to capture and treat the water quality design storm volume (when using the simple sizing method described below). Off-line sand filters can be located either upstream or downstream of detention Best Management Practices (BMPs). Online sand filters should be located only downstream of detention.

### Simple Sizing Method

This method applies to the off-line placement of a sand filter upstream or downstream of detention BMPs. A conservative design approach is provided below using a routing adjustment factor that does not require flow routing computations through the filter. An alternative simple approach for off-line placement downstream of detention BMPs is to route the full 2-year release rate from the detention BMP (sized for [2.7.7 Core Element #6: Flow Control](#)) to a sand filter with sufficient surface area for infiltration at that flow rate.

### Basic Sand Filter Sizing

For sizing a basic sand filter, a 0.7 routing adjustment factor is applied to compensate for routing through the sand bed at the maximum pond depth. A flow splitter should be designed to route the water quality design flow rate to the sand filter.

**Note:** An overflow should be included in the design of the sand filter pond. The overflow height should be at the maximum hydraulic head of the pond above the sand bed.

The stepwise procedure for designing basic sand filters for runoff treatment includes the following:

1. Determine the water quality design flow rate (Q) to the basic sand filter BMP for the given contributing area ( $A_t$ ). See [Chapter 4 - Hydrologic Analysis and Design](#).
2. Define initial BMP geometry, including the maximum sand filter pond depth (d) and sand bed depth (L).
3. Calculate the flow rate at which runoff is filtered by the sand filter bed and the sand filter surface area using Darcy's Law to account for the increased flow through the sand bed caused by the hydraulic head variations in the pond above the sand bed, as follows:

#### **Equation 5.9: Basic Sand Filter Flow Rate**

$$Q_{sf} = K * i * A_{sf} = F * A_{sf}$$

#### **Equation 5.10: Basic Sand Filter Surface Area**

$$A_{sf} = A_t * Q_d * R / (K * [h + L] / [L * t])$$

where:

$Q_{sf}$ =flow rate at which runoff is filtered by the sand filter bed (cubic feet [cf]/day or cubic feet per second [cfs])

K=hydraulic conductivity of the sand bed. Use 2 feet per day (ft/day) or 1.0 inch per hour (in/hr) at full presedimentation

$i$ =hydraulic gradient of the pond above the filter;  $(h + L) / L$ , (feet per foot [ft/ft])

$A_{sf}$ =sand filter surface area (sf)

F=filtration rate (ft/day or in/hr)

$A_t$ =contributing area (sf)

$Q_d$ =design storm runoff depth (ft) for the water quality design storm (Q). See [Chapter 4 - Hydrologic Analysis and Design](#).

R=routing adjustment factor

$h=d/2$  (ft)

$d$ =maximum sand filter pond depth (ft)

$L$ =sand bed depth (ft)

$t$ =maximum drawdown time (hrs). Use 24 hours from the completion of inflow into the sand filter pond (assume ponded presettling basin) of a discrete storm event to the completion of outflow from the sand filter underdrain of that same storm event

[Table 5.31: Sizing Methods and Assumptions for Basic Sand Filter BMPs](#) summarizes the methods and assumptions for the above steps for sizing basic sand filter BMPs.

**Table 5.31: Sizing Methods and Assumptions for Basic Sand Filter BMPs**

Steps	Variable	Methods and Assumptions
1	Water Quality Design Flow Rate ( $Q^a$ )	See <a href="#">Chapter 4 - Hydrologic Analysis and Design</a> for methods for computing design storms.
1, 3	Contributing Area ( $A_t$ )	Per design
2, 3	Maximum Sand Filter Pond Depth ( $d$ )	Per design
2, 3	Sand Bed Depth ( $L$ )	$L = 1.5$ ft (typical, may vary per design)
2, 3	Flow Rate at Which Runoff is Filtered by the Sand Filter Bed ( $Q_{sf}$ )	Calculate using Darcy's Law
2, 3	Sand Filter Surface Area ( $A_{sf}$ )	Calculate using Darcy's Law
3	Hydraulic Conductivity of the Sand Bed ( $K$ )	$K = 2$ ft/day or 1.0 in/hr
3	Hydraulic Gradient of Pond Above the Filter ( $i$ )	Calculate, $i = (h + L) / L$ , where $h = d/2$
	Design Storm Runoff Depth ( $Q_d$ )	Calculated for Q using the SCS Curve Number

**Table 5.31: Sizing Methods and Assumptions for Basic Sand Filter BMPs (continued)**

Steps	Variable	Methods and Assumptions
		equations. See <a href="#">Chapter 4 - Hydrologic Analysis and Design</a> .
3	Routing Adjustment Factor (R)	R = 0.7
3	Filtration Rate (F)	Calculate, $F = K * i$
3	Maximum Drawdown Time (t)	t = 24 hours
<sup>a</sup> See local jurisdiction requirements for calculating peak flow rates.		

### Example Calculation

- Sedimentation basin fully ponded and no pond water above sand filter
- Full sedimentation prior to sand filter – 24 hours residence of water quality storm runoff
- $A_t = 10$  acres
- $Q_d = 0.92$  inches (0.0767 ft), for Yakima rainfall
- Curve number = 96.2 for 85% impervious and 15% grass tributary surfaces
- R = 0.7
- t = 24 hr
- d = 3 ft
- h = 1.5 ft
- K = 2.0 ft/day (1 in/hr)

Using [Equation 5.10: Basic Sand Filter Surface Area](#):

$$A_{sf} = (10 \text{ acres} * 43,560 \text{ sf/acre} * 0.0767 \text{ ft}) / ([0.7 / 2.0 \text{ ft/day}] * [1.5 \text{ ft} + 1.5 \text{ ft}] / [1.5 \text{ ft} * 1 \text{ day}]) = 5,846 \text{ sf}$$

Therefore,  $A_{sf} = 5,846$  sf at pond depth of 3 ft

### Construction Criteria

No runoff should enter the sand filter prior to completion of construction and approval of site stabilization by the responsible inspector. Construction runoff may be routed to a pretreatment BMP, but discharge from sedimentation BMPs should bypass downstream sand filters. Careful level placement of the sand is necessary to avoid formation of voids within the sand that could lead to short-circuiting, (particularly around penetrations for underdrain clean-outs) and to prevent damage to the underlying geomembranes and underdrain system. Overcompaction should be avoided to ensure adequate filtration capacity. Sand is best placed with a low-ground-pressure bulldozer ( $\leq$



4 pounds per square inch gauge [psig]). After the sand layer is placed, water settling is recommended. Flood the sand with 10 to 15 gallons of water per cubic foot of sand.

### ***Operation and Maintenance Criteria***

Inspections of sand filters and pretreatment systems should be conducted every 6 months and after storm events as needed during the first year of operation, and annually thereafter if filter performs as designed. Repairs should be performed as necessary. Suggestions for maintenance include the following:

- Accumulated silt and debris on top of the sand filter should be removed when their depth exceeds 0.5 inches. The silt should be scraped off during dry periods with steel rakes or other devices. Once sediment is removed, the design permeability of the filtration media can typically be restored by then striating the surface layer of the media. Finer sediments that have penetrated deeper into the filtration media can reduce the permeability to unacceptable levels, necessitating replacement of some or all of the sand.
- Sand replacement frequency is not well established and will depend on suspended solids levels entering the filter (the effectiveness of the pretreatment BMP can be a significant factor).
- Frequent overflow into the spillway or overflow structure or slow drawdown are indicators of plugging problems. A sand filter should empty in 24 hours following a storm event (24 hours for the presettling chamber), depending on pond depth. If the hydraulic conductivity decreases to 1 in/hr, corrective action such as the following is needed:
  - Scraping the top layer of fine-grain sediment accumulation (midwinter scraping is suggested)
  - Removing of vegetation
  - Aerating the filter surface
  - Tilling the filter surface (late-summer rototilling is suggested)
  - Replacing the top 4 inches of sand
  - Inspecting geotextiles for clogging
- Rapid drawdown in the sand bed (> 12 in/hr) indicates short-circuiting of the filter. Inspect the clean-outs on the underdrain pipes and along the base of the embankment for leakage.
- Drawdown tests for the sand bed could be conducted, as needed, during the wet season. These tests can be conducted by allowing the filter to fill (or partially fill) during a storm event, then measuring the decline in water level over a 4- to 8-hour period. An inlet and an underdrain outlet valve would be necessary to conduct such a test.
- Formation of rills and gullies on the surface of the filter indicates improper function of the inlet flow spreader or poor sand compaction. Check for accumulation of debris on or in the flow spreader and refill rills and gullies with sand.
- Avoid driving heavy equipment on the filter to prevent compaction and rut formation.

See [Appendix 5-A: Recommended Maintenance Criteria for Runoff Treatment BMPs](#) for recommended maintenance criteria.

## **BMP T5.81: Large Sand Filter**

Large sand filters are expected to remove  $\geq 50\%$  of the total phosphorus by collecting and treating 95% of the runoff volume ([ASCE and WEF, 1998](#)).

### **General Criteria**

See the general criteria for [BMP T5.80: Basic Sand Filter](#).

### **Design Procedure**

For sizing a large sand filter, use the same procedure as outlined above for the basic sand filter. Then apply a scale-up factor of 1.6 to the surface area ( $A_{sf}$ ). This is considered a reasonable average for various impervious tributary sources. For a large sand filter, the flow splitter upstream or downstream of the detention Best Management Practice (BMP) should be designed to route the flow rate associated with conveying 95% of the annual runoff volume to the sand filter. Use the standard water quality design flow rate multiplied by 1.2.

### **Construction Criteria**

See the construction criteria for [BMP T5.80: Basic Sand Filter](#).

### **Operation and Maintenance Criteria**

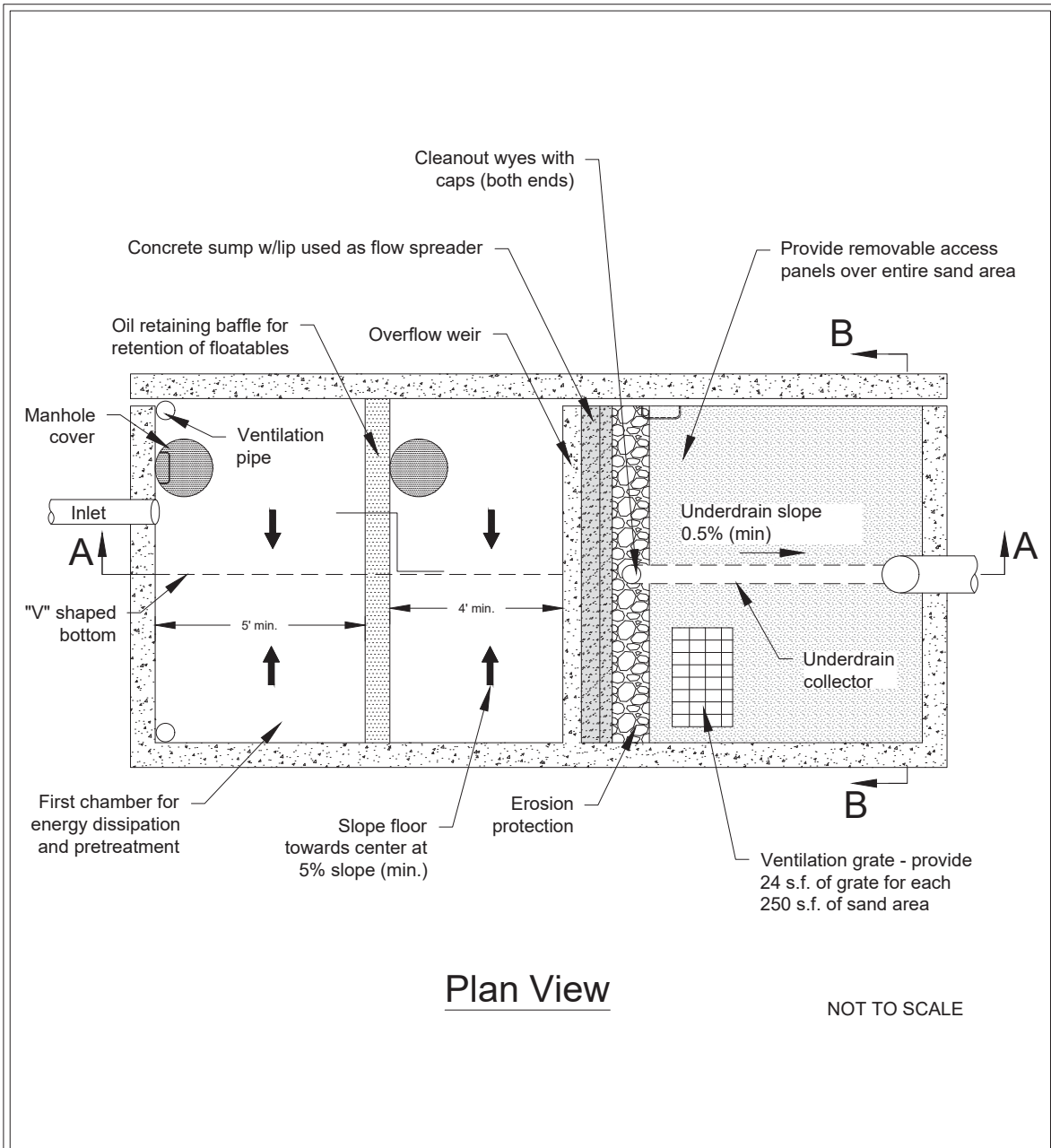
See the operation and maintenance criteria for [BMP T5.80: Basic Sand Filter](#).

## **BMP T5.82: Sand Filter Vault**

A sand filter vault is similar to an open sand filter except that the sand layer and underdrains are installed below grade in a vault. It consists of presettling and sand filtration cells. See [Figure 5.23: Sand Filter Vault](#), [Figure 5.24: Sand Filter Vault \(cont'd\)](#), and [Figure 5.25: Sand Filter Vault \(Also Called Underground Sand Filter\)](#).

Underground Injection Control regulations do not apply to sand filter vaults unless a vault is deeper than it is wide at the ground surface, and then—provided that the design, operation, and maintenance criteria in this section are met—only the registration requirement would apply. See [5.6 Subsurface Infiltration \(Underground Injection Control Wells\)](#).

**Figure 5.23: Sand Filter Vault**



**Plan View**

NOT TO SCALE

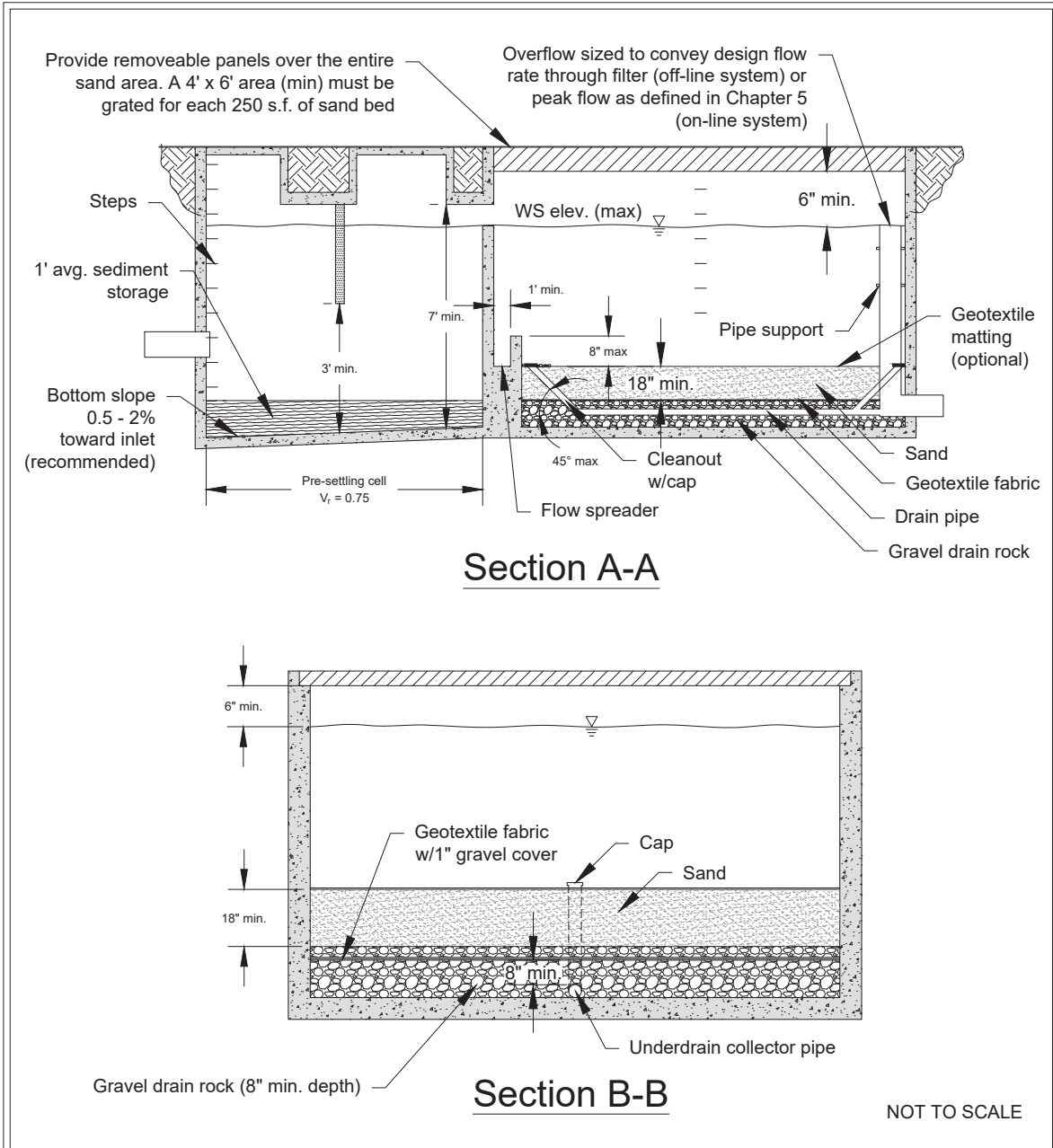


## Sand Filter Vault

Revised June 2016

Please see <http://www.ecy.wa.gov/copyright.html> for copyright notice including permissions, limitation of liability, and disclaimer.

**Figure 5.24: Sand Filter Vault (cont'd)**

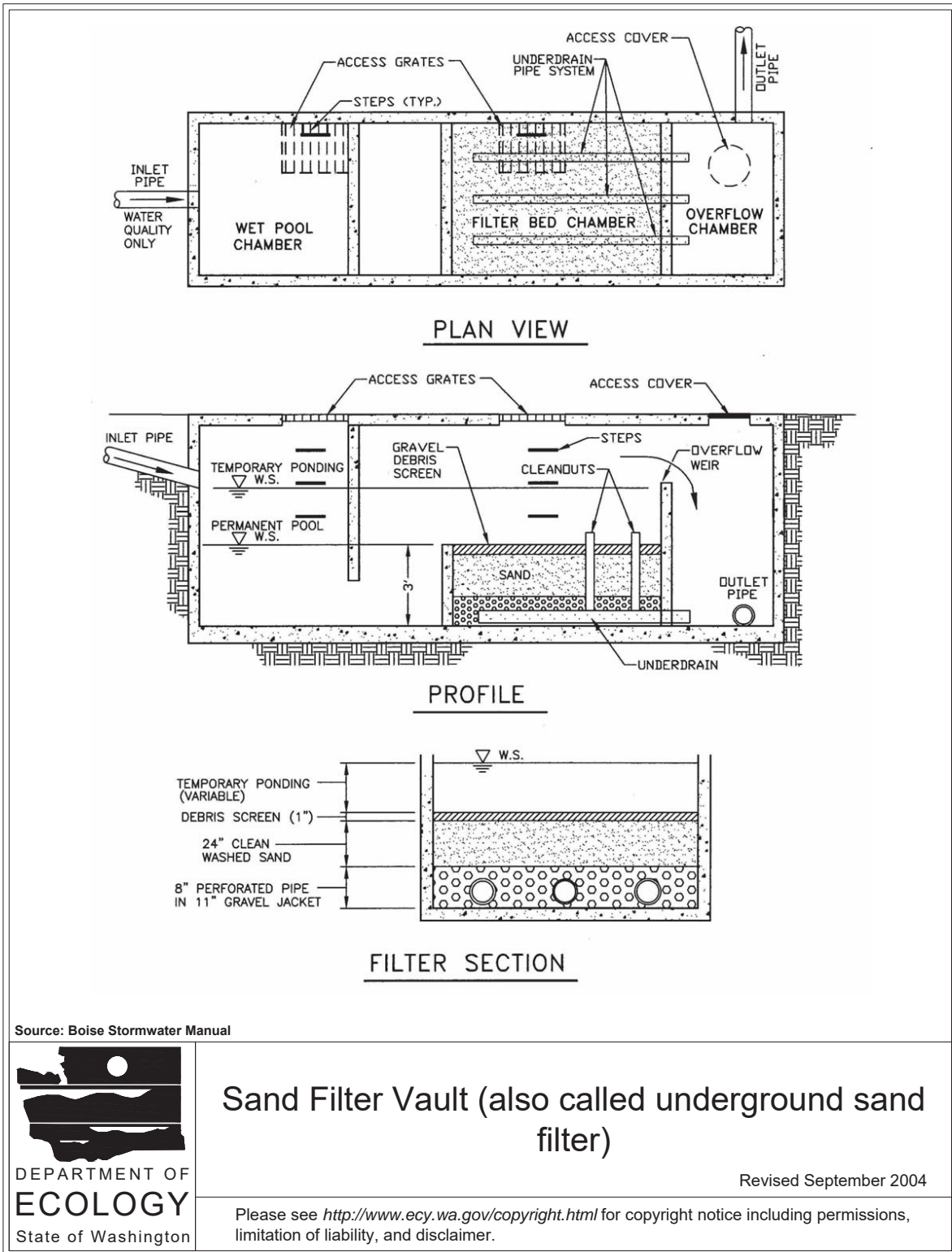


**Sand Filter Vault (continued)**

Revised June 2016

Please see <http://www.ecy.wa.gov/copyright.html> for copyright notice including permissions, limitation of liability, and disclaimer.

**Figure 5.25: Sand Filter Vault (Also Called Underground Sand Filter)**



## General Criteria

Use the following criteria for siting sand filter vaults:

- Use where space limitations preclude aboveground BMPs.
- Not suitable where high water table and heavy sediment loads are expected.
- An elevation difference of 4 feet between inlet and outlet is needed.

The following additional criteria apply to design of sand filter vaults:

- Vaults may be designed as off-line systems or online for small drainages.
- In an off-line system, a diversion structure should be installed to divert the water quality design flow rate into the sediment chamber and bypass the remaining flow to a detention/retention BMP (if necessary to meet [2.7.7 Core Element #6: Flow Control](#)), or to surface water.
- Optimize sand inlet flow distribution with minimal sand bed disturbance. A maximum distance of 8 inches between the top of the spreader and the top of the sand bed is suggested. Flows may enter the sand bed by spilling over the top of the wall into a flow spreader pad or alternatively a pipe and manifold system may be used. Any pipe and manifold system must retain the required permanent pool volume in the first cell, minimize turbulence, and be readily maintainable.
- If an inlet pipe and manifold system is used, the minimum pipe size should be 8 inches. Multiple inlets are recommended to minimize turbulence and reduce local flow velocities.
- Erosion protection must be provided along the first foot of the sand bed adjacent to the spreader. Geotextile fabric secured on the surface of the sand bed, or equivalent method, may be used.
- The filter bed should consist of a sand top layer, and a geotextile fabric second layer with an underdrain system.
- Design the presettling cell for sediment collection and removal. A V-shaped bottom, removable bottom panels, or equivalent sludge handling system should be used. A 1-foot depth of sediment storage in the presettling cell must be provided.
- The presettling chamber should be constructed to trap oil and trash. This chamber is usually connected to the sand filtration chamber with an invert elbow or underflow baffle to protect the filter surface from oil and trash.
- If a retaining baffle is necessary for oil/floatables in the presettling cell, it must extend  $\geq 1$  foot above to 1 foot below the design flow water level. Provision for the passage of flows in the event of plugging must be provided. Access opening and ladder must be provided on both sides of the baffle.
- To prevent anoxic conditions, a minimum of 24 square feet (sf) of ventilation grate should be provided for each 250 sf of sand bed surface area. For sufficient distribution of airflow across the sand bed, grates may be located in one area if the sand filter is small, but placement at each end is preferred. Small grates may also be dispersed over the entire sand bed area.

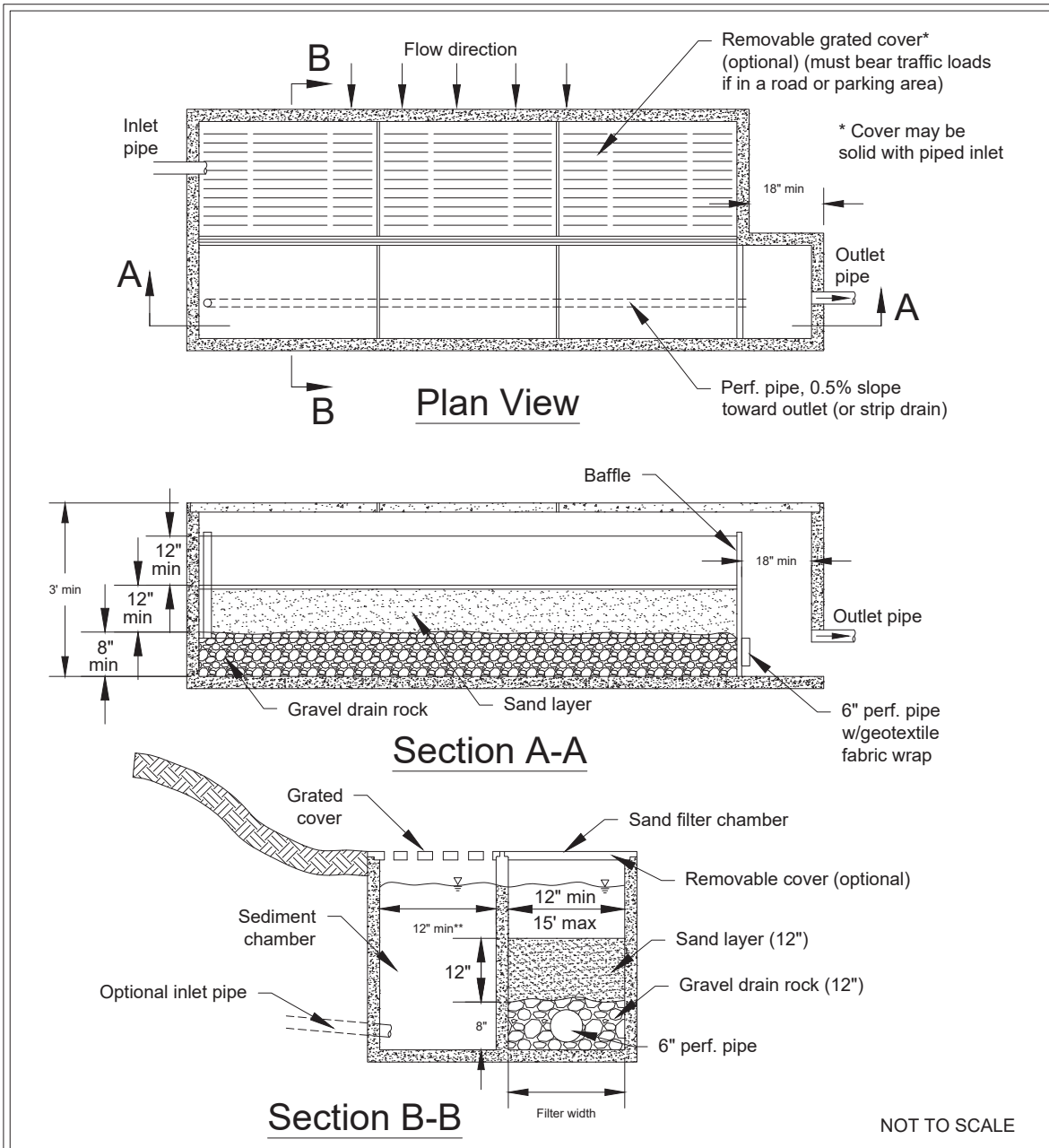
- Provision for access is the same as for wetvaults. Removable panels must be provided over the sand bed.
- Sand filter vaults must conform to the materials and structural suitability criteria specified for wetvaults.
- Provide a sand filter inlet shutoff/bypass valve for maintenance.
- A geotextile fabric over the entire sand bed may be installed that is flexible, highly permeable, three-dimensional matrix, and adequately secured. This is useful in trapping trash and litter.

### **BMP T5.83: Linear Sand Filter**

Linear sand filters ([Figure 5.26: Linear Sand Filter](#)) are typically long, shallow, two-celled, rectangular vaults. The first cell is designed for settling coarse particles, and the second cell contains the sand bed. Stormwater flows into the second cell via a weir section that also functions as a flow spreader.

Underground Injection Control regulations apply to linear sand filters. Provided that the design, operation, and maintenance criteria in this section are met, only the registration requirement would apply. See [5.6 Subsurface Infiltration \(Underground Injection Control Wells\)](#).

**Figure 5.26: Linear Sand Filter**



## Linear Sand Filter

Revised June 2016

Please see <http://www.ecy.wa.gov/copyright.html> for copyright notice including permissions, limitation of liability, and disclaimer.



**General Criteria**

Use the following criteria for siting linear sand filters:

- Applicable in long narrow spaces such as the perimeter of a paved surface
- As a part of a treatment train as downstream of a filter strip, upstream of an infiltration system, or upstream of a wetpond or a biofiltration Best Management Practice (BMP) for oil control
- To treat small drainages (< 2 acres of impervious area)
- To treat runoff from high-use sites for total suspended solids (TSS) and oil/grease removal, if applicable

The following additional criteria apply to the design of linear sand filters:

- The two cells should be divided by a divider wall that is level and extends a minimum of 12 inches above the sand bed.
- Stormwater may enter the sediment cell by sheet flow or a piped inlet.
- The width of the sand cell must be 1 foot minimum to 15 feet maximum.
- The sand filter bed must be a minimum of 12 inches deep and have an 8-inch layer of drain rock with perforated drainpipe beneath the sand layer.
- The drainpipe must be a minimum of 6 inches in diameter, wrapped in geotextile, and sloped a minimum of 0.5%.
- Maximum sand bed ponding depth is 1 foot.
- Must be vented as for sand filter vaults.
- Linear sand filters must conform to the materials and structural suitability criteria specified for wetvaults.
- Set sediment cell width as shown in [Table 5.32: Sediment Cell Width as a Function of Sand Filter Width](#):

**Table 5.32: Sediment Cell Width as a Function of Sand Filter Width**

Sand Filter Dimension	Width (inches)			
Sand filter width	12 to 24	24 to 48	48 to 72	72+
Sediment cell width	12	18	24	w/3

**BMP T5.84: Media Filter Drain**

The media filter drain (MFD), previously referred to as the ecology embankment, is a linear flow-through stormwater runoff treatment device that can be sited along highway side slopes (conventional design) and medians (dual MFDs), borrow ditches, or other linear depressions. Cut-slope

applications may also be considered. The MFD can be used where available right-of-way is limited, sheet flow from the highway surface is feasible, and lateral gradients are generally < 25% (4H:1V). The MFD has a General Use Level Designation (GULD) for basic treatment, metals treatment, and phosphorus treatment. Updates/changes to the use-level designation and any design changes will be posted on the HRM Resource web page at the following address:

<http://www.wsdot.wa.gov/Environment/WaterQuality/Runoff/HighwayRunoffManual.htm>

MFDs have four basic components: a gravel no-vegetation zone, a grass strip, the MFD mix bed, and a conveyance system for flows leaving the MFD mix. This conveyance system usually consists of a gravel-filled underdrain trench or a layer of crushed surfacing base course (CSBC). This layer of CSBC must be porous enough to allow treated flows to freely drain away from the MFD mix.

### **General Criteria**

See the latest version of the Washington State Department of Transportation (WSDOT) *Highway Runoff Manual* (HRM) for general criteria.

### **Design Procedure**

See the latest version of the WSDOT HRM for design procedures for sizing in eastern Washington.

### **Construction Criteria**

Keep effective erosion and sediment control measures in place until grass strip is established.

Do not allow vehicles or traffic on the MFD to minimize rutting and maintenance repairs.

### **Operation and Maintenance Criteria**

Maintenance will consist of routine roadside management. While herbicides must not be applied directly over the MFD, it may be necessary to periodically control noxious weeds with herbicides in areas around the MFD as part of a roadside management program. The use of pesticides may be prohibited if the MFD is in a critical aquifer recharge area for drinking water supplies. The designer should check with the local area water purveyor or local health department. Areas of the MFD that show signs of physical damage will be replaced by local maintenance staff in consultation with region hydraulics/water quality staff.

## **5.9 Evaporation BMPs**

### **BMP T5.90: Evaporation Ponds**

Evaporation ponds are ponds with no outlet that settle out the suspended solids, heavy metals, and hydrocarbons and may be used for runoff treatment.

**For more information:** See [BMP F6.30: Evaporation Ponds](#) for details on designing evaporation ponds and [Appendix 6-A: Recommended Maintenance Criteria for Flow Control BMPs](#) for maintenance criteria.

## 5.10 Oil and Water Separator BMPs

### 5.10.1 Introduction to Oil and Water Separator BMPs

This section provides a discussion of oil and water separators, including their application and design criteria. Best Management Practices (BMPs) are described for baffle-type and coalescing-plate-type (CP-type) separators.

### 5.10.2 Purpose

Oil and water separators remove oil and other water-insoluble hydrocarbons and settleable solids from stormwater runoff. Typical types include the American Petroleum Institute (API), also called the baffle-type, separator ([API, 1990](#)) or the CP-type separator using a gravity mechanism for separation. See [Figure 5.27: API \(Baffle-Type\) Separator](#) and [Figure 5.28: Coalescing Plate Separator](#).

Oil and water separators typically consist of three bays; forebay, separator section, and the afterbay. The CP separators need considerably less space for separation of the floating oil due to the shorter travel distances between parallel plates.

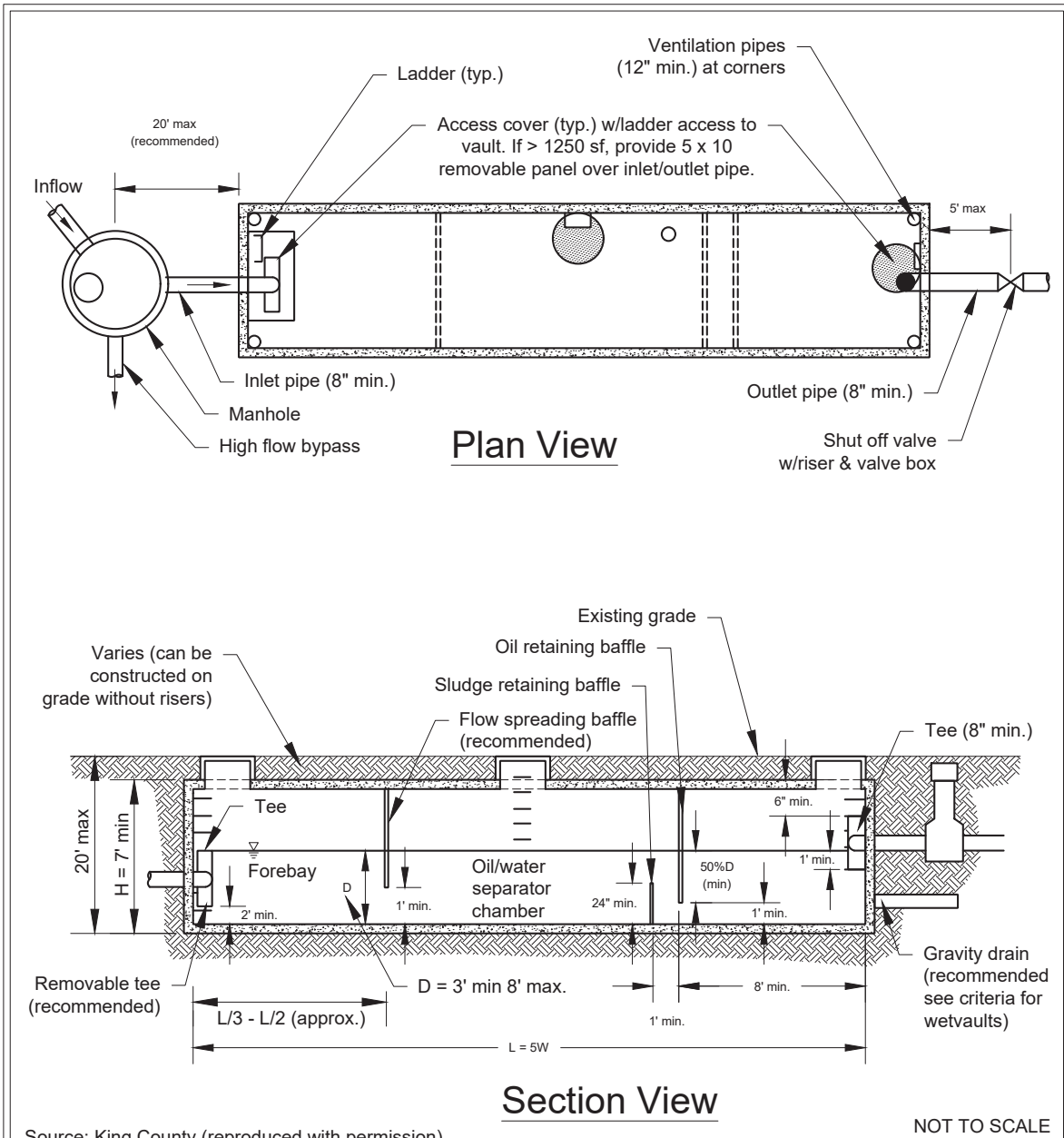
Oil and water separators should be designed to remove oil and total petroleum hydrocarbons (TPH) down to 15 milligrams per liter (mg/L) at any time and 10 mg/L on a 24-hour average, and produce a discharge that does not cause an ongoing or recurring visible sheen in the stormwater discharge or in the receiving water (see also [5.2 Runoff Treatment BMP Selection Process](#)).

Two BMPs are described in this section:

- [BMP T5.100: API Separator Bay](#)
- [BMP T5.110: Coalescing Plate \(CP\) Separator Bay](#)

Underground Injection Control (UIC) regulations do not apply to oil and water separators if the outlet structure discharges exclusively to a conveyance system and/or to surface water. However, the UIC regulations do apply to oil and water separators if the outlet structure discharges into the ground, and then—provided that the design and operation and maintenance criteria in this section are met—only the registration requirement would apply. See [5.6 Subsurface Infiltration \(Underground Injection Control Wells\)](#).

**Figure 5.27: API (Baffle-Type) Separator**

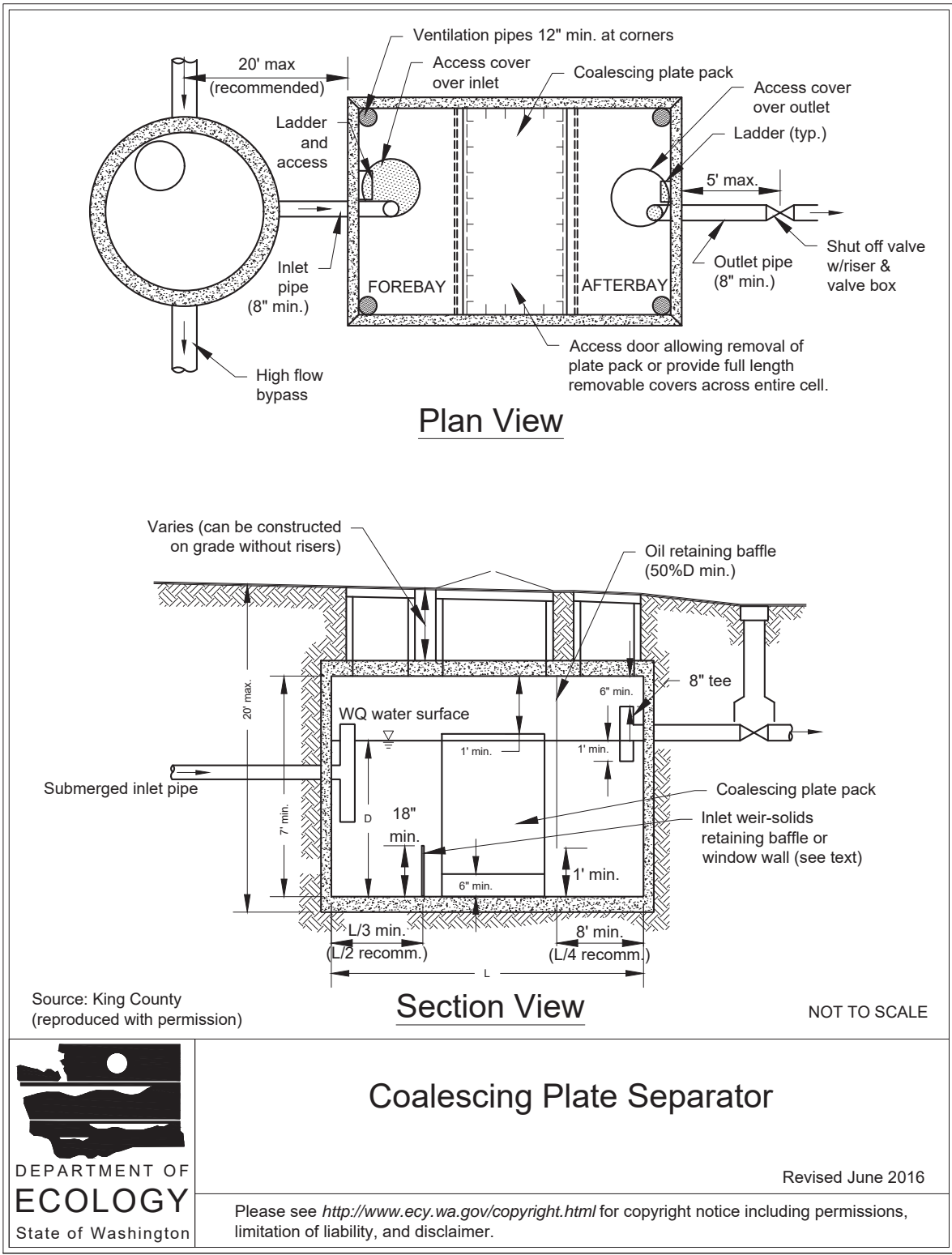


## API (Baffle Type) Separator

Revised June 2016

Please see <http://www.ecy.wa.gov/copyright.html> for copyright notice including permissions, limitation of liability, and disclaimer.

**Figure 5.28: Coalescing Plate Separator**



DEPARTMENT OF  
**ECOLOGY**  
State of Washington

## Coalescing Plate Separator

Revised June 2016

Please see <http://www.ecy.wa.gov/copyright.html> for copyright notice including permissions, limitation of liability, and disclaimer.

### 5.10.3 Application

The following are potential applications of oil and water separators where free oil is expected to be present at treatable high concentrations and sediment will not overwhelm the separator ([Romano, 1990](#)), ([Watershed Protection Techniques, 1994](#)), ([King County, 2016](#)). For low concentrations of oil, other treatments may be more applicable. These include sand filters ([5.8 Filtration BMPs](#)) and emerging technologies ([5.11 Emerging Technologies](#)). Table [Table 5.33: Applicability of Oil and Water Separator BMPs for Runoff Treatment, Flow Control, and Conveyance](#) summarizes the applicability of oil and water separator BMPs for runoff treatment, flow control, and conveyance.

**Table 5.33: Applicability of Oil and Water Separator BMPs for Runoff Treatment, Flow Control, and Conveyance**

BMP	Runoff Treatment					Flow Control	Conveyance
	Pretreatment	Basic	Metals	Oil Control	Phosphorus		
<a href="#">BMP T5.100: API Separator Bay</a>				✓			
<a href="#">BMP T5.110: Coalescing Plate (CP) Separator Bay</a>				✓			

Facilities that would require oil control BMPs under the high-use site definition in [Chapter 2 - Core Elements for New Development and Redevelopment](#) include parking lots at convenience stores, fast food restaurants, grocery stores, shopping malls, discount warehouse stores, banks, truck fleets, auto and truck dealerships, and delivery and commercial and industrial areas including petroleum storage yards, vehicle maintenance facilities, manufacturing areas, airports, utility areas (water, electric, gas), and fueling stations. High-ADT roadways and parking areas (defined in the glossary) also require oil control BMPs.

Without intense maintenance, oil and water separators may not be sufficiently effective in achieving oil and TPH removal down to required levels. See the recommended operation and maintenance criteria this section.

Pretreatment should be considered if the level of total suspended solids (TSS) in the inlet flow would cause clogging or otherwise impair the long-term efficiency of the separator.

For inflows from small contributing areas (fueling stations, maintenance shops, etc.), a CP-type separator is typically considered, due to space limitations. However, if plugging of the plates is likely, then a new design basis for the baffle-type API separator may be considered on an experimental basis (see “General Criteria” for the BMPs in [5.10.6 BMPs for Oil and Water Separation](#)).

### 5.10.4 Cold Weather Climate Considerations

Check with the manufacturer on cold weather climate considerations.

## 5.10.5 Arid/Semiarid Climate Considerations

Check with the manufacturer on arid/semiarid climate considerations.

## 5.10.6 BMPs for Oil and Water Separation

### BMP T5.100: API Separator Bay

#### General Criteria

Consider the following site characteristics for siting Best Management Practices (BMPs) using an American Petroleum Institute (API) separator bay:

- Sufficient land area
- Adequate total suspended solids (TSS) control or pretreatment capability
- Compliance with environmental objectives
- Adequate influent flow attenuation and/or bypass capability
- Sufficient access for operation and maintenance (O&M)

There is concern that oil and water separators used for stormwater treatment have not performed to expectations ([Watershed Protection Techniques, 1994](#)), ([Schueler, 1992](#)). Therefore, emphasis should be given to proper application (see [5.10.3 Application](#)), design, O&M (particularly sludge and oil removal), and prevention of CP fouling and plugging ([USACE, 1994](#)). Other treatment systems, such as sand filters and emerging technologies, should be considered for the removal of insoluble oil and total petroleum hydrocarbons (TPH).

The following are design criteria applicable to API and coalescing plate (CP) oil and water separators:

- If practicable, determine oil/grease (or TPH) and TSS concentrations, lowest temperature, pH; and empirical oil rise rates in the runoff, and the viscosity, and specific gravity of the oil. Also determine whether the oil is emulsified or dissolved. Do not use oil and water separators for the removal of dissolved or emulsified oils such as coolants, soluble lubricants, glycols, and alcohols.
  - Locate the oil and water separator off-line and bypass flows in excess of the water quality design flow rate. For model time increments of 30 minutes or greater, the water quality design flow rate is the instantaneous peak flow rate calculated by the model.
  - For model time increments < 30 minutes (e.g., where the short-duration storm is applied), the water quality design flow rate is the average of the flow rates generated by the model over the peak 30-minute period.
- Use only impervious conveyances for oil-contaminated stormwater.
- Specify appropriate performance tests after installation and shakedown, and/or certification by a licensed engineer in the state of Washington that the separator is functioning in

accordance with design objectives. Expedient corrective actions must be taken if it is determined the separator is not achieving acceptable performance levels.

- Add pretreatment for TSS that could cause clogging of the CP separator or otherwise impair the long-term effectiveness of the separator.

### **Separator Bays**

- Size the separator bay for the water quality design flow rate as follows:
  - For model time increments of 30 minutes or greater, the water quality design flow rate is the instantaneous peak flow rate calculated by the model.
  - For model time increments < 30 minutes (e.g., where the short-duration storm is applied), the water quality design flow rate is the average of the flow rates generated by the model over the peak 30-minute period.
- To collect floatables and settleable solids, design the surface area of the forebay at 20 sf per 10,000 sf of area draining to the separator. The length of the forebay should be one-third to one-half the length of the entire separator. Include roughing screens for the forebay or upstream of the separator to remove debris, if needed. Screen openings should be about 0.75 inches.
- Include a submerged inlet pipe with a turn-down elbow in the first bay  $\geq 2$  feet from the bottom. The outlet pipe should be a tee, sized to pass the design peak flow and placed  $\geq 12$  inches below the water surface.
- Include a shutoff mechanism at the separator outlet pipe ([King County, 2016](#)).
- Use absorbents and/or skimmers in the afterbay as needed.

### **Baffles**

- Oil-retaining baffles (top baffles) should be located  $\geq$  at one-quarter the total separator length from the outlet and should extend down  $\geq 50\%$  of the water depth and  $\geq 1$  foot from the separator bottom.
- Baffle height to water depth ratios should be 0.85 for top baffles and 0.15 for bottom baffles.

### ***Design Procedure***

The design procedure for small drainages is based on the design velocity, oil rise rate, residence time, width, depth, and length considerations. The Washington State Department of Ecology (Ecology) modified the API criteria for treating stormwater runoff from small impervious contributing areas of  $\leq 2$  acres (e.g., fueling stations, commercial parking lots, etc.). Ecology's modified criteria differ from the API criteria as follows:

- Use the design hydraulic horizontal velocity ( $V_h$ ) for the design  $V_h/V_t$  ratio, rather than the API minimum of  $V_h/V_t = 15$ ,
- Use an oil droplet diameter ( $D$ ) of 60 microns, rather than the API formula where  $D = (Q / (2 *$



$V_h))^{1/2}$ .

- Use a depth to width ratio (d/w) of 0.5, rather than the API range of 0.3 to 0.5.

Ecology considers the API criteria to be applicable for > 2 acres of impervious contributing area. Performance verification of this design basis must be obtained during at least one wet season using the test protocol referenced in Section 5.11 for new technologies.

Use [Method 1 – Modified API Criteria for Small Impervious Contributing Areas](#) for small impervious contributing areas of ≤ 2 acres and [Method 2 – API Criteria for Large Impervious Contributing Areas](#) for larger areas.

### **Method 1 – Modified API Criteria for Small Impervious Contributing Areas**

The stepwise procedure for designing API separator bay BMPs using Ecology’s modified API criterion for small impervious contributing areas of ≤ 2 acres includes the following:

1. Determine the oil rise rate ( $V_t$ ) in cm/sec, using one of the following three options:
  - Stoke’s Law ([Water Pollution Control Federation, 1985](#))
  - Empirical determination
  - Default value of 0.033 feet per minute (ft/min) for a 60-micron droplet of oil

The use of Stoke’s Law or empirical rise rates is preferred over the default value because they account for the actual site-based oil droplet sizes and densities and better represent the actual site conditions.

Stoke’s Law equation for rise rate:

#### **Equation 5.11: API Separator Rise Rate (Stoke's Law) (Method 1)**

$$V_t = g * (\rho_w - \rho_o) * D^2 / (18 * \mu_w)$$

where:

$V_t$  = rise rate of the oil droplet (centimeters per second [cm/sec])

$g$  = acceleration due to gravity (981 cm/sec<sup>2</sup>)

$\rho_w$  = density of water at the design temperature (0.999 gm/cc at 32 degrees Fahrenheit [°F])

$\rho_o$  = density of oil at the design temperature (gm/cc). Select conservatively high oil density, for example: if diesel oil @  $\rho_o = 0.85$  gm/cc and motor oil @  $\rho_o = 0.90$  can be present, then use  $\rho_o = 0.90$  gm/cc.

$D$  = oil droplet diameter (cm). Use oil droplet diameter  $d = 60$  microns (0.006 cm).

$\mu_w$  = absolute viscosity of the water (0.017921 poise at a water temperature of 32°F)

2. Use the following separator dimension criteria:

- Separator water depth (d) =  $\geq 3$  and  $\leq 8$  ft to minimize turbulence ([API, 1990](#)), ([USACE, 1994](#))
  - Separator width (w) = 6 to 20 ft ([ASCE and WEF, 1998](#)), ([King County, 2016](#))
  - Depth to width ratio (d/w) = 0.3 to 0.5 ([API, 1990](#))
3. Calculate the minimum residence time of the separator at depth:

**Equation 5.12: API Separator Minimum Residence Time (Method 1)**

$$t_m = d / V_t$$

where:

$t_m$  = minimum residence time (min)

d = depth (cm)

$V_t$  = the rise rate of the oil droplet (cm/sec)

4. Calculate the horizontal velocity of the bulk fluid:

**Equation 5.13: API Separator Horizontal Velocity of Bulk Fluid (Method 1)**

$$V_h = Q / (d * w) = Q / A_v$$

where:

$V_h$  = horizontal velocity of the bulk fluid (ft/min), maximum value  $< 2.0$  ft/min ([API, 1990](#))

Q = water quality design flow rate (cf/min), at minimum residence time ( $t_m$ )

$A_v$  = vertical cross-sectional area (sf) = d \* w

5. Determine the API turbulence and short-circuiting factor. Use [Figure 5.29: Recommended Values of F for Various Values of  \$V\_h/V\_t\$](#)  based on the ratio of the rise rate of the oil droplet to the horizontal velocity of the bulk fluid ( $V_h/V_t$ ). F values range from 1.28 to 1.74. ([API, 1990](#))
6. Calculate the minimum length of the separator section:

**Equation 5.14: API Separator Minimum Length (Method 1)**

$$l(s) = (F * Q * t_m) / (w * d) = F * (V_h/V_t) * d$$

**Equation 5.15: API Separator Bay Length (Method 1, Equation 1)**

$$l(t) = l(f) + l(s) + l(a)$$

**Equation 5.16: API Separator Bay Length (Method 1, Equation 2)**

$$l(t) = l(t)/3 + l(s) + l(t)/4$$

where:

$l(s)$  = length of separator section (ft)

$F$  = turbulence and short-circuiting factor (Figure 5.10.3)

$Q$  = water quality design flow rate (cf/min), at minimum residence time ( $t_m$ )

$t_m$  = minimum residence time (min)

$V_h$  = horizontal velocity of the bulk fluid (ft/min)

$V_t$  = oil rise rate (cm/sec)

$l(t)$  = total length of three bays (ft)

$l(f)$  = length of forebay (ft)

$l(a)$  = length of afterbay (ft)

7. Calculate the minimum hydraulic design volume using:

**Equation 5.17: API Separator Minimum Hydraulic Design Volume (Method 1)**

$$V = l(s) * w * d = F * Q * t_m$$

where:

$V$  = minimum hydraulic design volume (cf)

$l(s)$  = length of separator section (ft)

$w$  = width (ft)

$d$  = depth (ft)

$F$  = turbulence and short-circuiting factor ([Figure 5.29: Recommended Values of F for Various Values of  \$V\_h/V\_t\$](#) )

$Q$  = water quality design flow rate (cf/min), at minimum residence time ( $t_m$ )

$t_m$  = minimum residence time (min)

8. Calculate the minimum horizontal area of the separator using:

**Equation 5.18: API Separator Minimum Horizontal Area (Method 1)**

$$A_h = w * l(s)$$

where:

$A_h$  = minimum horizontal area of the separator (sf)  
 $w$  = width (ft)

$l(s)$  = length of separator section (ft)

Table [Table 5.34: Sizing Methods and Assumptions for BMP T5.100 API Separator Bay \(Method 1\)](#) provides a summary of this sizing procedure and assumptions.

**Table 5.34: Sizing Methods and Assumptions for BMP T5.100 API Separator Bay (Method 1)**

Step	Variable	Methods and Assumptions	Notes/Sources
1	Oil rise rate ( $V_t$ )	Use Stoke's Law ( <a href="#">Equation 5.11: API Separator Rise Rate (Stoke's Law) (Method 1)</a> ), empirical determination, or default value 0.033 ft/min for 60 micron droplet size oil.	Use of Stoke's Law or empirical rise rates is preferred over the default value in order to represent site conditions.
2	Separator water depth (d)	<ul style="list-style-type: none"> <li>• Minimum = 3 feet</li> <li>• Maximum = 8 feet</li> </ul>	<a href="#">(API, 1990)</a> , <a href="#">(USACE, 1994)</a>
2	Separator width (w)	<ul style="list-style-type: none"> <li>• Minimum = 6 feet</li> <li>• Maximum = 20 feet</li> </ul>	<a href="#">(ASCE and WEF, 1998)</a> , <a href="#">(King County, 2016)</a>
2	Depth to width ratio (d/w)	<ul style="list-style-type: none"> <li>• Minimum = 0.3</li> <li>• Maximum = 0.5</li> </ul>	<a href="#">(API, 1990)</a>
3	Minimum residence time ( $t_m$ )	Use <a href="#">Equation 5.12: API Separator Minimum Residence Time (Method 1)</a>	<a href="#">(API, 1990)</a>
4	Horizontal velocity of the bulk fluid ( $V_h$ )	<ul style="list-style-type: none"> <li>• Use <a href="#">Equation 5.13: API Separator Horizontal Velocity of Bulk Fluid (Method 1)</a></li> <li>• Maximum &lt; 2.0 ft/min</li> </ul>	<a href="#">(API, 1990)</a>
5	Turbulence and short-circuiting factor (F)	<ul style="list-style-type: none"> <li>• Use <a href="#">Figure 5.29: Recommended Values of F for Various Values of <math>V_h/V_t</math></a> based on the ratio <math>V_h/V_t</math></li> <li>• Minimum = 1.28</li> <li>• Maximum = 1.74</li> </ul>	<a href="#">(API, 1990)</a>
6	Minimum length of the separator section (l(s))	Use <a href="#">Equation 5.14: API Separator Minimum Length (Method 1)</a> to <a href="#">Equation 5.16: API Separator Bay Length (Method 1, Equation 2)</a>	<a href="#">(API, 1990)</a>
7	Minimum hydraulic design volume (V)	Use <a href="#">Equation 5.17: API Separator Minimum Hydraulic Design Volume (Method 1)</a>	<a href="#">(API, 1990)</a>
8	Minimum horizontal area of the separator ( $A_h$ )	Use <a href="#">Equation 5.18: API Separator Minimum Horizontal Area (Method 1)</a>	<a href="#">(API, 1990)</a>

**Method 2 – API Criteria for Large Impervious Contributing Areas**

For stormwater inflow from drainages > 2 acres, repeat Steps 1 through 8 in Method 1, above, using the following values:

**Equation 5.19: API Separator Horizontal Velocity of Bulk Fluid (Method 2)**

$$V_h = 15 * V_t$$

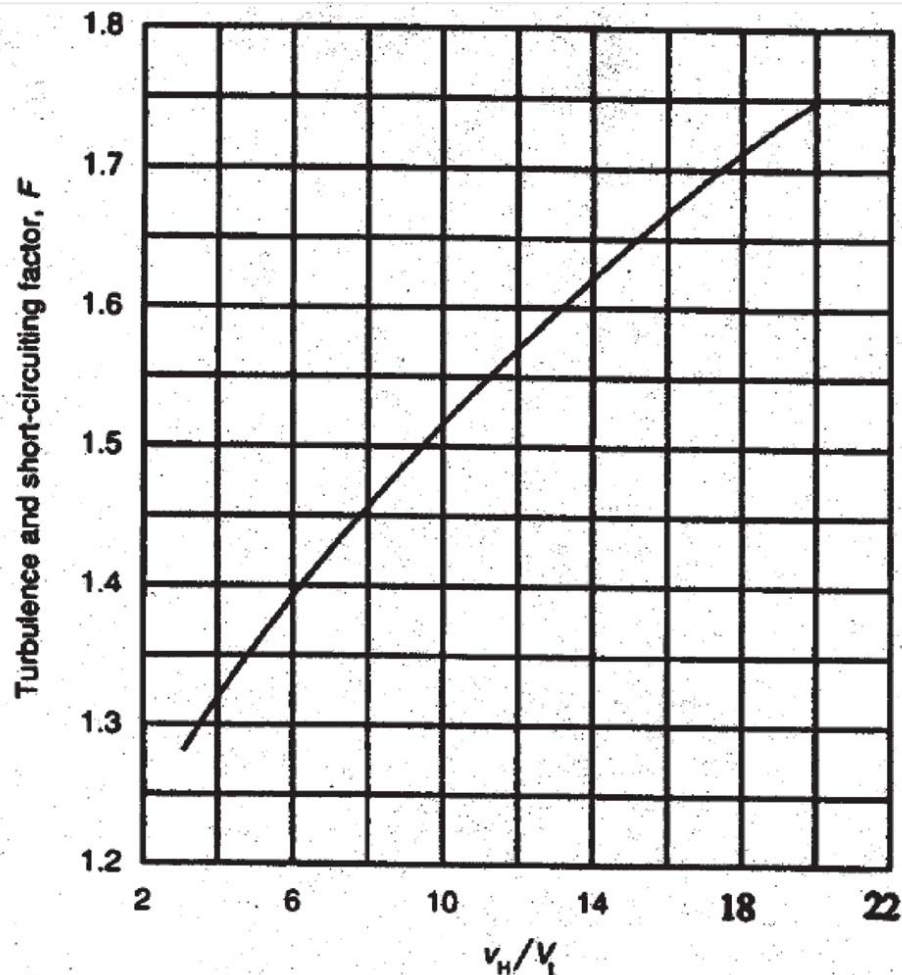
**Equation 5.20: API Separator Oil Droplet Diameter (Method 2)**

$$D = (Q / (2 * V_h))^{1/2}$$

**Equation 5.21: API Separator Depth to Width Ratio (Method 2)**

$$d/w = 0.5$$

**Figure 5.29: Recommended Values of F for Various Values of  $v_H/V_t$**



$v_H/V_t$	Turbulence Factor ( $F_t$ )	$F = 1.2(F_t)$
20	1.45	1.74
15	1.37	1.64
10	1.27	1.52
6	1.14	1.37
3	1.07	1.28



### Recommended Values for $F$ for Various Values of $v_H/V_t$

Revised June 2016

Please see <http://www.ecy.wa.gov/copyright.html> for copyright notice including permissions, limitation of liability, and disclaimer.

## Construction Criteria

Check with the manufacturer for construction criteria.

## Operation and Maintenance Criteria

- Prepare, regularly update, and implement an operation and maintenance manual for the oil and water separators.
- Inspect oil and water separators monthly during the wet season of October 1 through June 30 ([ASCE and WEF, 1998](#)), ([Woodward-Clyde, 1995](#)) to ensure proper operation, and during and immediately after a large storm event of  $\geq 1$  inch per 24 hours. In Climate Region 2, it is most important to check these BMPs in the spring before the summer thunderstorm season begins; one annual check at this time of year should be sufficient for oil and water separators in Climate Region 2.
- Clean oil and water separators regularly to keep accumulated oil from escaping during storms. They must be cleaned by October 15 to remove material that has accumulated during the dry season ([Woodward-Clyde, 1995](#)), after all spills and after a significant storm. A Vactor truck may be used for extracting accumulated solids and oils ([King County, 2016](#)).
- Remove the accumulated oil when the thickness is  $\geq 1$  inch.
- Remove sediment deposits when the thickness is  $\geq 6$  inches ([King County, 2016](#)).
- Replace oil absorbent pads before their sorbed oil content reaches capacity.
- Train designated employees on appropriate oil and water separator operation, inspection, record keeping, and maintenance procedures.

See manufacturer's recommendations and [Appendix 5-A: Recommended Maintenance Criteria for Runoff Treatment BMPs](#) for recommended maintenance criteria.

## BMP T5.110: Coalescing Plate (CP) Separator Bay

### General Criteria

- Plate spacing should be a minimum of 0.75 inches (perpendicular distance between plates) ([ASCE and WEF, 1998](#)), ([USACE, 1994](#)), ([USAF, 1991](#)), ([Jaisinghani and Sprenger, 1979](#)).
- Select a plate angle between 45 and 60 degrees from the horizontal.
- Locate plate pack  $\geq 6$  inches from the bottom of the separator for sediment storage.
- Add 12 inches minimum head space from the top of the plate pack and the bottom of the vault cover.
- Design inlet flow distribution and baffles in the separator bay to minimize turbulence, short-circuiting, and channeling of the inflow especially through and around the plate packs of the coalescing plate (CP) separator. The Reynolds Number through the separator bay should be  $< 500$  (laminar flow).
- Include forebay for floatables and afterbay for collection of effluent ([ASCE and WEF, 1998](#)).

- The sediment-retaining baffle must be upstream of the plate pack at a minimum height of 18 inches ([King County, 2016](#)).
- Design plates for ease of removal and cleaning with high-pressure rinse or equivalent.

### **Design Procedure**

Calculate the projected (horizontal) surface area of plates needed using the following equation:

#### **Equation 5.22: CP Separator Horizontal Surface Area of Plates (Equation 1)**

$$A_h = Q / V_t = Q / [0.00386 * (S_w - S_o / \mu_w)]$$

#### **Equation 5.23: CP Separator Horizontal Surface Area of Plates (Equation 2)**

$$A_h = A_a * (\text{cosine } b)$$

where:

$A_h$  = horizontal surface area of the plates in square feet (sf)

Q = water quality design flow rate, cubic feet per minute (cf/min)

$V_t$  = rise rate of the oil droplet, use 0.033 feet per minute (ft/min) or empirical determination, or based on Stoke's Law

0.00386 = unit conversion constant (dimensionless)

$S_w$  = specific gravity of water at the design temperature (32 degrees Fahrenheit [°F]) (dimensionless)

$S_o$  = specific gravity of oil at the design temperature (32°F) (dimensionless)

$\mu_w$  = absolute viscosity of the water at 32°F (poise)

$A_a$  = actual plate area in sf (one side only)

b = angle of the plates with the horizontal in degrees (usually varies from 45 to 60 degrees).

### **Construction Criteria**

Check with the manufacturer for construction criteria.

### **Operation and Maintenance Criteria**

- Prepare, regularly update, and implement an operation and maintenance manual for the oil and water separators.
- Inspect oil and water separators monthly during the wet season of October 1 through June 30 ([ASCE and WEF, 1998](#)), ([Woodward-Clyde, 1995](#)) to ensure proper operation, and during and immediately after a large storm event of  $\geq 1$  inch per 24 hours. In Climate Region 2, it is most important to check these BMPs in the spring before the summer thunderstorm season begins; one annual check at this time of year should be sufficient for oil and water separators



in Climate Region 2.

- Clean oil and water separators regularly to keep accumulated oil from escaping during storms. They must be cleaned by October 15 to remove material that has accumulated during the dry season ([Woodward-Clyde, 1995](#)), after all spills and after a significant storm. Coalescing plates may be cleaned in situ or after removal from the separator. A Vactor truck may be used for extracting accumulated solids and oils removal ([King County, 2016](#)).
- Remove the accumulated oil when the thickness is  $\geq 1$  inch.
- Remove sediment deposits when the thickness is  $\geq 6$  inches ([King County, 2016](#)).
- Replace oil absorbent pads before their sorbed oil content reaches capacity.
- Train designated employees on appropriate oil and water separator operation, inspection, record keeping, and maintenance procedures.

See manufacturer's recommendations and [Appendix 5-A: Recommended Maintenance Criteria for Runoff Treatment BMPs](#) for recommended maintenance criteria.

## 5.11 Emerging Technologies

### 5.11.1 Background

Traditional Best Management Practices (BMPs) such as wetponds and filtration swales may not be appropriate in many situations due to size and space restraints or their inability to remove target pollutants. Because of this, the stormwater treatment industry emerged to develop new stormwater treatment devices.

Emerging technologies are stormwater treatment devices that are new to the stormwater treatment marketplace. These devices include both permanent and construction site treatment technologies. Many of these devices have not undergone complete performance testing so their performance claims cannot be verified.

### 5.11.2 Ecology Role in Evaluating Emerging Technologies

To aid local jurisdictions in selecting new stormwater treatment technologies, the Washington State Department of Ecology (Ecology) developed the Technology Assessment Protocol–Ecology (TAPE) and Chemical Technology Assessment Protocol–Ecology (CTAPE) protocols. These protocols provide manufacturers with guidance on stormwater monitoring so they may verify their performance claims.

As part of this process, Ecology:

- Posts information on emerging technologies on its Emerging Stormwater Treatment Technologies (TAPE) web page at the following address:  
<https://ecology.wa.gov/Regulations-Permits/Guidance-technical-assistance/Stormwater-permittee-guidance-resources/Emerging-stormwater-treatment-technologies>
- Participates in all Technical Review Committee (TRC) and Chemical Technical Review

Committee (CTRC) activities that include reviewing manufacturer performance data and providing recommendations on use level designations; and

- Provides oversight and analysis of all submittals to ensure consistency with the *Stormwater Management Manual for Eastern Washington* (manual).

### **5.11.3 Local Jurisdiction Evaluation of Emerging Technologies**

Local jurisdictions should consider the following as they make decisions concerning the use of new stormwater technologies in their jurisdiction:

- Remember the goal: The goal of any stormwater management program or BMP is to treat and release stormwater in a manner that does not harm beneficial uses.
- Exercise reasonable caution:
  - Before allowing the use of a new technology, the local jurisdiction should review evaluation information based on the TAPE or CTAPE.
  - An emerging technology cannot be used for new development or redevelopment unless this technology has a use level designation. Having a use level designation means that Ecology and the TRC or CTRC reviewed system performance data and believe the technology has the ability to provide the level of treatment claimed by the manufacturer.

To achieve the goals of the Clean Water Act and the Endangered Species Act, local jurisdictions may find it necessary to retrofit stormwater pollutant control systems for many existing stormwater discharges. In retrofit situations, the use of any BMPs that make substantial progress toward these goals is a step forward and encouraged by Ecology. To the extent practical, the performance of these BMPs used in retrofit situations should be evaluated using the TAPE or CTAPE protocols.

### **5.11.4 Assessing Levels of Development of Emerging Technologies**

Ecology's Emerging Stormwater Treatment Technologies (TAPE) web page lists technologies that have obtained a use level designation through the TAPE process. Ecology's website also provides additional guidance regarding the TAPE process and application forms.

Ecology's Emerging Stormwater Treatment Technologies (TAPE) web page is at the following address:

<https://ecology.wa.gov/Regulations-Permits/Guidance-technical-assistance/Stormwater-permittee-guidance-resources/Emerging-stormwater-treatment-technologies>

In addition to Ecology certification, local jurisdiction approval is required for installation of treatment technologies with a Pilot Use Level Designation (PULD), Conditional Use Level Designation (CULD), or General Use Level Designation (GULD). Local jurisdictions may choose not to accept products approved through TAPE or may require additional testing prior to consideration for local approval.

In addition to other requirements, Ecology uses the goals below to evaluate emerging stormwater treatment technologies. Proponents attempting to obtain a GULD for a stormwater treatment technology must demonstrate the achievement of applicable performance goals by monitoring the water quality parameters listed in [Table 5.35: TAPE Treatment Goals and Water Quality Parameters](#).

## ***Pretreatment***

Pretreatment is generally applied to the following:

- Project sites using infiltration treatment
- Treatment systems needed to ensure and extend performance of the downstream basic or metals treatment BMP

**Pretreatment Performance Goal:** The goals depend on the range of influent concentrations:

- < 100 milligrams per liter (mg/L): achieve effluent goals of 50 mg/L of fine and 20 mg/L of coarse total suspended solids (TSS).
- > 100 mg/L but < 200 mg/L: achieve 50% removal of fine (50-micron mean size) and 80% removal of coarse (125-micron mean size) TSS.

## ***Oil Control***

**Oil Control Performance Goal:** Achieve no ongoing or recurring visible sheen and a daily average total petroleum hydrocarbon (TPH) concentration < 10 mg/L with a maximum of 15 mg/L for discrete (grab) samples.

## ***Basic Treatment***

**Basic Treatment Effluent Goals:** The goals depend on the range of influent concentrations:

- < 100 mg/L: achieve an effluent of 20 mg/L TSS.
- From 100 to 200 mg/L: achieve 80% removal of TSS.
- > 200 mg/L: achieve > 80% removal of TSS.

Ecology has also approved technologies listed in this section with a GULD for pretreatment.

## ***Metals Treatment***

**Metals Treatment Performance Goal:** Achieve a higher level of treatment than basic treatment. The goal depends on the range of influent concentrations:

- Dissolved copper 0.005 to 0.02 mg/L: meet basic treatment goal and better than basic treatment currently defined as > 30% dissolved copper removal.
- Dissolved zinc 0.02 to 0.3 mg/L: meet basic treatment goal and better than basic treatment currently defined as > 60% dissolved zinc removal.

## Phosphorus Treatment

**Phosphorus Performance Treatment Goal:** Achieve 50% total phosphorus removal for an influent concentration range of 0.1 to 0.5 mg/L and achieve basic treatment goals.

## Construction Site Treatments

**Construction Performance Treatment Goal:** Achieve a maximum of 5 nephelometric turbidity units (NTU) above background (background of  $\leq 50$  NTU),  $< 10\%$  increase in turbidity where background is  $> 50$  NTU, pH of 6.5 to 8.5 in fresh water and 7.0 to 8.5 in marine water, and no visible oil sheen.

**Table 5.35: TAPE Treatment Goals and Water Quality Parameters**

Performance Goal	Influent Range	Criteria	Required Water Quality Parameters
Basic Treatment	20 to 100 mg/L TSS	Effluent goal $\leq 20$ mg/L TSS <sup>a</sup>	TSS
	100 to 200 mg/L TSS	$\geq 80\%$ TSS removal <sup>b</sup>	
	$> 200$ mg/L TSS	$> 80\%$ TSS removal <sup>b</sup>	
Metals Treatment <sup>c</sup>	Dissolved copper 0.005 to 0.02 mg/L	Must meet basic treatment goal and better than basic treatment currently defined as $> 30\%$ dissolved copper removal <sup>b,d</sup>	TSS, hardness, total and dissolved copper and zinc
	Dissolved zinc 0.02 to 0.3 mg/L	Must meet basic treatment goal and better than basic treatment currently defined as $> 60\%$ dissolved zinc removal <sup>b,d</sup>	
Phosphorus Treatment	Total phosphorus (TP) 0.1 to 0.5 mg/L	Must meet basic treatment goal and exhibit $\geq 50\%$ TP removal <sup>b</sup>	TSS, TP, orthophosphate
Oil Control	Total petroleum hydrocarbons (TPH) $> 10$ mg/L <sup>e</sup>	<ol style="list-style-type: none"> <li>1. No ongoing or recurring visible sheen in effluent</li> <li>2. Daily average effluent TPH concentration <math>&lt; 10</math> mg/L<sup>a,e</sup></li> <li>3. Maximum effluent TPH concentration of 15 mg/L<sup>a,e</sup> for a discrete (grab) sample</li> </ol>	NWTPH-Dx, visible sheen
Pretreatment <sup>f</sup>	50 to 100 mg/L TSS	Effluent goal $\leq 50$ mg/L TSS <sup>a</sup>	TSS
	$\geq 100$ mg/L TSS	$> 50\%$ TSS removal <sup>b</sup>	

Notes for [Table 5.35: TAPE Treatment Goals and Water Quality Parameters](#):

- BMP = Best Management Practice
- mg/L = milligrams per liter
- NWTPH-Dx = Northwest Total Petroleum Hydrocarbons—Motor Oil and Diesel fractions
- TAPE = Technology Assessment Protocol—Ecology
- TPH = total petroleum hydrocarbons
- TSS = total suspended solids
- <sup>a</sup> The upper one-sided 95% confidence interval around the mean effluent concentration for the treatment system being evaluated must be lower than this performance goal to meet the performance goal with the required 95% confidence.
- <sup>b</sup> The lower one-sided 95% confidence interval around the mean removal efficiency for the treatment system being evaluated must be higher than this performance goal to meet the performance goal with the required 95% confidence.
- <sup>c</sup> Referred to as Enhanced Treatment in the *Stormwater Management Manual for Western Washington* and Metals Treatment in the *Stormwater Management Manual for Eastern Washington*. Must meet the removal goal for both dissolved copper and dissolved zinc in order to achieve a General Use Level Designation (GULD) for a dissolved metals treatment GULD. Meeting the removal goal for only one of these dissolved metals is not sufficient.
- <sup>d</sup> This percent removal was determined based on an analysis of the basic treatment BMP dissolved metals removal data from the International Stormwater BMP database to define performance goals for dissolved metals treatment ([Herrera, 2011](#)). Data from the International Stormwater BMP database were reviewed and screened based on influent concentrations, geographic location, data quality, BMP design, and monitoring problems to develop a subset of data that were representative and suitable for determining BMP performance.
- <sup>e</sup> This performance goal should be evaluated based on the motor oil fraction of TPH-Dx only.
- <sup>f</sup> Pretreatment technologies generally apply to (1) project sites using infiltration treatment and (2) treatment systems where pretreatment is needed to ensure and extend performance of the downstream basic or dissolved metals treatment BMPs.

*This page has been intentionally left blank for double-sided printing.*

## **Appendix 5-A: Recommended Maintenance Criteria for Runoff Treatment BMPs**

### **5.A.1 Introduction**

The Best Management Practice (BMP)-specific maintenance criteria contained in this appendix are intended to be conditions for determining if maintenance actions are required as identified through inspection. They are not intended to be measures of the required condition of the BMP at all times between inspections. In other words, an exceedance of these conditions at any time between inspections and/or maintenance does not automatically constitute a violation of these criteria. However, based on inspection observations, the inspection and maintenance schedules shall be adjusted to minimize the length of time that a BMP is in a condition that requires a maintenance action.

*This page has been intentionally left blank for double-sided printing.*



## 5.A.2 Maintenance Criteria for Wetponds

**Table 5.36: Maintenance Criteria for Wetponds**

Maintenance Component	Defect	Conditions When Maintenance Is Needed	Results Expected When Maintenance Is Performed
General	Trash and Debris	Any trash and debris > 5 cubic feet (cf) per 1,000 square feet (sf). (This is about equal to the amount of trash it would take to fill up one standard size garbage can). In general, there should be no visual evidence of dumping.  If less than threshold, all trash and debris will be removed as part of next scheduled maintenance.	Trash and debris cleared from site.
	Poisonous Vegetation and Noxious Weeds	Any poisonous or nuisance vegetation that may constitute a hazard to maintenance personnel or the public.  Any evidence of noxious weeds as defined by state or local regulations.  (Apply requirements of adopted integrated pest management policies for the use of herbicides).	No danger of poisonous vegetation where maintenance personnel or the public might normally be. (Coordinate with local health department).  Complete eradication of noxious weeds may not be possible. Compliance with state or local eradication policies required.
	Contaminants and Pollution	Any evidence of oil, gasoline, contaminants or other pollutants  (Coordinate removal/cleanup with local water quality response agency).	No contaminants or pollutants present.
	Rodent Holes	Any evidence of rodent holes if wetpond is acting as a dam or berm, or any evidence of water piping through dam or berm via rodent holes.	Rodents destroyed and dam or berm repaired. (Coordinate with local health department; coordinate with the Washington State Department of Ecology Dam Safety Office if pond ≥ 10 acre-feet.)
	Beaver Dams	Dam results in change or function of the wetpond.	Wetpond is returned to design function.  (Coordinate trapping of beavers and removal of dams with appropriate permitting agencies.)
	Insects	When insects such as wasps and hornets interfere with maintenance activities.	Insects destroyed or removed from site.  Apply insecticides in compliance with adopted integrated pest management policies.
	Tree Growth and Hazard Trees	Tree growth does not allow maintenance access or interferes with maintenance activity (i.e., slope mowing, silt removal, Vactoring, or equipment movements). If trees are not interfering with access or maintenance, do not remove.  If dead, diseased, or dying trees are identified.  (Use a certified arborist to determine health of tree or removal requirements.)	Trees do not hinder maintenance activities. Harvested trees should be recycled into mulch or other beneficial uses (e.g., alders for firewood).  Remove hazard trees.
Side Slopes of Pond	Erosion  Eroded damage > 2 inches deep where cause of damage is still present or where there is potential for continued erosion.  Any erosion observed on a compacted berm embankment.	Slopes should be stabilized using appropriate erosion control measure(s); e.g., rock reinforcement, planting of grass, compaction.  If erosion is occurring on compacted berms, a licensed engineer in the state of Washington should be consulted to resolve source of erosion.	
Storage Area	Sediment	Accumulated sediment > 10% of the designed pond depth unless otherwise specified or affects inletting or outletting condition of the wetpond.	Sediment cleaned out to designed pond shape and depth; pond reseeded if necessary to control erosion.
	Liner (if applicable)	Liner is visible and has > three 0.25-inch holes in it.	Liner repaired or replaced. Liner is fully covered.
Pond Berms (Dikes)	Settlements  Any part of berm that has settled 4 inches lower than the design elevation.  If settlement is apparent, measure berm to determine amount of settlement.	Dike is built back to the design elevation.	

**Table 5.36: Maintenance Criteria for Wetponds (continued)**

Maintenance Component	Defect	Conditions When Maintenance Is Needed	Results Expected When Maintenance Is Performed
		Settling can be an indication of more severe problems with the berm or outlet works. A licensed engineer in the state of Washington should be consulted to determine the source of the settlement.	
	Piping	Discernible water flow through pond berm. Ongoing erosion with potential for erosion to continue.  (Recommend a licensed engineer in the state of Washington with geotechnical expertise be called in to inspect and evaluate condition and recommend repair of condition.)	Piping eliminated. Erosion potential resolved.
Emergency Overflow/ Spillway and Berms Over 4 Feet in Height	Tree Growth	Tree growth on emergency spillways creates blockage problems and may cause failure of the berm due to uncontrolled overtopping.  Tree growth on berms > 4 feet in height may lead to piping through the berm, which could lead to failure of the berm.	Trees should be removed. If root system is small (base < 4 inches) the root system may be left in place. Otherwise the roots should be removed and the berm restored. A licensed engineer in the state of Washington should be consulted for proper berm/spillway restoration.
	Piping	Discernible water flow through pond berm. Ongoing erosion with potential for erosion to continue.  (Recommend a licensed engineer in the state of Washington with geotechnical expertise be called in to inspect and evaluate condition and recommend repair of condition.)	Piping eliminated. Erosion potential resolved.
Emergency Overflow/ Spillway	Emergency Overflow/ Spillway	Only one layer of rock exists above native soil in area $\geq 5$ sf, or any exposure of native soil at the top of outflow path of spillway.  (Riprap on inside slopes need not be replaced.)	Rocks and pad depth are restored to design standards.
General	Water Level	First cell is empty, doesn't hold water.	Line the first cell to maintain $\geq 4$ feet of water. Although the second cell may drain, the first cell must remain full to control turbulence of the incoming flow and reduce sediment resuspension.
	Trash and Debris	Accumulation > 1 cf per 1,000 sf of pond area.	Trash and debris removed from pond.
	Inlet/Outlet Pipe	Inlet/outlet pipe clogged with sediment and/or debris material.	No clogging or blockage in the inlet and outlet piping.
	Sediment Accumulation in Pond Bottom	Sediment accumulations in pond bottom that exceeds the depth of sediment zone plus 6 inches, usually in the first cell.	Sediment removed from pond bottom.
	Oil Sheen on Water	Prevalent and visible oil sheen.	Oil removed from water using oil-absorbent pads or Vactor truck. Source of oil located and corrected. If chronic low levels of oil persist, plant wetland plants such as <i>Juncus effusus</i> (soft rush) which can uptake small concentrations of oil.
	Erosion	Erosion of the pond's side slopes and/or scouring of the pond bottom > 6 inches, or where continued erosion is prevalent.	Slopes stabilized using proper erosion control measures and repair methods.
	Settlement of Pond Dike/Berm	Any part of these components that has settled 4 inches or lower than the design elevation, or inspector determines dike/berm is unsound.	Dike/berm is repaired to specifications.
	Internal Berm	Berm dividing cells should be level.	Berm surface is leveled so that water flows evenly over entire length of berm.
	Overflow Spillway	Rock is missing and soil is exposed at top of spillway or outside slope.	Rocks replaced to specifications.

### 5.A.3 Maintenance Criteria for Bioinfiltration/Infiltration Trenches/Basins

**Table 5.37: Maintenance Criteria for Bioinfiltration/Infiltration Trenches/Basins**

Maintenance Component	Defect	Conditions When Maintenance Is Needed	Results Expected When Maintenance Is Performed
General	Trash and Debris	See <a href="#">Table 5.36: Maintenance Criteria for Wetponds</a>	See <a href="#">Table 5.36: Maintenance Criteria for Wetponds</a>
	Poisonous/ Noxious Vegetation	See <a href="#">Table 5.36: Maintenance Criteria for Wetponds</a>	See <a href="#">Table 5.36: Maintenance Criteria for Wetponds</a>
	Contaminants and Pollution	See <a href="#">Table 5.36: Maintenance Criteria for Wetponds</a>	See <a href="#">Table 5.36: Maintenance Criteria for Wetponds</a>
	Rodent Holes	See <a href="#">Table 5.36: Maintenance Criteria for Wetponds</a>	See <a href="#">Table 5.36: Maintenance Criteria for Wetponds</a>
Storage Area	Sediment	Water ponding in infiltration pond after rainfall ceases and appropriate time allowed for infiltration. (A percolation test pit or test of BMP indicates BMP is only working at 90% of its designed capabilities. If $\geq 2$ inches of sediment is present, remove).	Sediment is removed and/or BMP is cleaned so that infiltration system works according to design.
Rock Filters	Sediment and Debris	By visual inspection, little or no water flows through filter during heavy rain storms.	Gravel in rock filter is replaced.
Side Slopes of Pond	Erosion	See <a href="#">Table 5.36: Maintenance Criteria for Wetponds</a>	See <a href="#">Table 5.36: Maintenance Criteria for Wetponds</a>
Emergency Overflow Spillway and Berms Over 4 Feet in Height	Tree Growth	See <a href="#">Table 5.36: Maintenance Criteria for Wetponds</a>	See <a href="#">Table 5.36: Maintenance Criteria for Wetponds</a>
	Piping	See <a href="#">Table 5.36: Maintenance Criteria for Wetponds</a>	See <a href="#">Table 5.36: Maintenance Criteria for Wetponds</a>
Emergency Overflow Spillway	Rock Missing	See <a href="#">Table 5.36: Maintenance Criteria for Wetponds</a>	See <a href="#">Table 5.36: Maintenance Criteria for Wetponds</a>
	Erosion	See <a href="#">Table 5.36: Maintenance Criteria for Wetponds</a>	See <a href="#">Table 5.36: Maintenance Criteria for Wetponds</a>
Presettling Ponds and Vaults	BMP or Sump Filled With Sediment and/or Debris	6 inches or designed sediment trap depth of sediment.	Sediment is removed.

## 5.A.4 Maintenance Criteria for Closed Treatment Systems (Tanks/Vaults)

**Table 5.38: Maintenance Criteria for Closed Treatment Systems (Tanks/Vaults)**

Maintenance Component	Defect	Conditions When Maintenance Is Needed	Results Expected When Maintenance Is Performed
Storage Area	Plugged Air Vents	One-half the cross section of a vent is blocked at any point or the vent is damaged.	Vents open and functioning.
	Debris and Sediment	Accumulated sediment depth > 10% of the diameter of the storage area for one-half the length of storage vault or any point depth > 15% of diameter.  (Example: 72-inch storage tank would require cleaning when sediment reaches depth of 7 inches for > one-half the length of tank.)	All sediment and debris removed from storage area.
	Joints Between Tank/Pipe Section	Any openings or voids allowing material to be transported into the tanks/vault.  (Will require engineering analysis to determine structural stability).	All joint between tank/pipe sections are sealed.
	Tank Pipe Bent out of Shape	Any part of tank/pipe is bent out of shape > 10% of its design shape. (Review required by licensed engineer in the state of Washington to determine structural stability).	Tank/pipe repaired or replaced to design.
	Vault Structure Includes Cracks in Wall, Cracks in Bottom, or Damage to Frame and/or Top Slab	Cracks > 0.5 inches and any evidence of soil particles entering the structure through the cracks, or maintenance/inspection personnel determines that the vault is not structurally sound.	Vault replaced or repaired to design specifications and is structurally sound.
Cracks > 0.5 inches at the joint of any inlet/outlet pipe or any evidence of soil particles entering the vault through the walls.		No cracks > 0.25 inches wide at the joint of the inlet/outlet pipe.	
Manhole	Cover Not in Place	Cover is missing or only partially in place. Any open manhole requires maintenance.	Manhole is closed.
	Locking Mechanism Not Working	Mechanism cannot be opened by one maintenance person with proper tools. Bolts into frame have < 0.5 inches of thread (may not apply to self-locking lids).	Mechanism opens with proper tools.
	Cover Difficult to Remove	One maintenance person cannot remove lid after applying normal lifting pressure. Intent is to keep cover from sealing off access to maintenance.	Cover can be removed and reinstalled by one maintenance person.
	Ladder Rungs Unsafe	Ladder is unsafe due to missing rungs, misalignment, not securely attached to structure wall, rust, or cracks.	Ladder meets design standards. Allows maintenance person safe access.
Catch Basins	See criteria in <a href="#">Table 5.40: Maintenance Criteria for Catch Basins</a> .		

## 5.A.5 Maintenance Criteria for Control Structure/Flow Restrictor for Wetponds

**Table 5.39: Maintenance Criteria for Control Structure/Flow Restrictor for Wetponds**

Maintenance Component	Defect	Condition When Maintenance Is Needed	Results Expected When Maintenance Is Performed
General	Trash and Debris (Includes Sediment)	Material > 25% of sump depth or 1 foot below orifice plate.	Control structure orifice is not blocked. All trash and debris removed.
	Structural Damage	Structure is not securely attached to manhole wall.	Structure securely attached to wall and outlet pipe.
		Structure is not in upright position (allow up to 10% from plumb).	Structure in correct position.
		Connections to outlet pipe are not watertight and show signs of rust.	Connections to outlet pipe are water tight; structure repaired or replaced and works as designed.
	Any holes—other than designed holes—in the structure.	Structure has no holes other than designed holes.	
Clean-Out Gate	Damaged or Missing	Clean-out gate is not watertight or is missing.	Gate is watertight and works as designed.
		Gate cannot be moved up and down by one maintenance person.	Gate moves up and down easily and is watertight.
		Chain/rod leading to gate is missing or damaged.	Chain is in place and works as designed.
		Gate is rusted > 50% of its surface area.	Gate is repaired or replaced to meet design standards.
Orifice Plate	Damaged or Missing	Control device is not working properly due to missing, out of place, or bent orifice plate.	Plate is in place and works as designed.
	Obstructions	Any trash, debris, sediment, or vegetation blocking the plate.	Plate is free of all obstructions and works as designed.
Overflow Pipe	Obstructions	Any trash or debris blocking (or having the potential of blocking) the overflow pipe.	Pipe is free of all obstructions and works as designed.
Manhole	See criteria for vaults/tanks in <a href="#">Table 5.38: Maintenance Criteria for Closed Treatment Systems (Tanks/Vaults)</a> .		
Catch Basin	See criteria in <a href="#">Table 5.40: Maintenance Criteria for Catch Basins</a> .		

## 5.A.6 Maintenance Criteria for Catch Basins

**Table 5.40: Maintenance Criteria for Catch Basins**

Maintenance Component	Defect	Conditions When Maintenance Is Needed	Results Expected When Maintenance Is Performed
General	Trash and Debris	Trash or debris that is located immediately in front of the catch basin opening or is blocking inletting capacity of the basin by > 10%.	No trash or debris located immediately in front of catch basin or on grate opening.
		Trash or debris (in the basin) > 60% of the sump depth as measured from the bottom of basin to invert of the lowest pipe into or out of the basin, but in no case < 6 inches clearance from the debris surface to the invert of the lowest pipe.	No trash or debris in the catch basin.
		Trash or debris in any inlet or outlet pipe blocking > one-third of its height.	Inlet and outlet pipes free of trash or debris.
		Dead animals or vegetation that could generate odors that could cause complaints or dangerous gases (e.g., methane).	No dead animals or vegetation present within the catch basin.
	Sediment	Sediment (in the basin) > 60% of the sump depth as measured from the bottom of basin to invert of the lowest pipe into or out of the basin, but in no case < 6 inches clearance from the sediment surface to the invert of the lowest pipe.	No sediment in the catch basin
Structure Damage to	Top slab has holes > 2 square inches or cracks > 0.25 inches	Top slab is free of holes and cracks.	

**Table 5.40: Maintenance Criteria for Catch Basins (continued)**

Maintenance Component	Defect	Conditions When Maintenance Is Needed	Results Expected When Maintenance Is Performed
	Frame and/or Top Slab	(Intent is to make sure no material is running into basin).	
		Frame not sitting flush on top slab, i.e., separation of > 0.75 inches of the frame from the top slab. Frame not securely attached	Frame is sitting flush on the riser rings or top slab and firmly attached.
	Fractures or Cracks in Basin Walls/Bottom	Maintenance person judges that structure is unsound.	Basin replaced or repaired to design standards.
	Fractures or Cracks in Basin Walls/Bottom (cont'd)	Grout fillet has separated or cracked > 0.5 inches and > 1 foot at the joint of any inlet/outlet pipe or any evidence of soil particles entering catch basin through cracks.	Pipe is regouted and secure at basin wall.
	Settlement/Misalignment	If failure of basin has created a safety, function, or design problem.	Basin replaced or repaired to design standards.
	Vegetation	Vegetation growing across and blocking > 10% of the basin opening.	No vegetation blocking opening to basin.
		Vegetation growing in inlet/outlet pipe joints that is > 6 inches tall and < 6 inches apart.	No vegetation or root growth present.
Contamination and Pollution	See "Wetponds" ( <a href="#">Table 5.36: Maintenance Criteria for Wetponds</a> ).	No pollution present.	
Catch Basin Cover	Cover Not in Place	Cover is missing or only partially in place. Any open catch basin requires maintenance.	Catch basin cover is closed
	Locking Mechanism Not Working	Mechanism cannot be opened by one maintenance person with proper tools. Bolts into frame have < 0.5 inches of thread.	Mechanism opens with proper tools.
	Cover Difficult to Remove	One maintenance person cannot remove lid after applying normal lifting pressure. (Intent is keep cover from sealing off access to maintenance.)	Cover can be removed by one maintenance person.
Ladder	Ladder Rungs Unsafe	Ladder is unsafe due to missing rungs, not securely attached to basin wall, misalignment, rust, cracks, or sharp edges.	Ladder meets design standards and allows maintenance person safe access.
Metal Grates (If Applicable)	Grate opening Unsafe	Grate with opening > 0.875 inches.	Grate opening meets design standards.
	Trash and Debris	Trash and debris that is blocking > 20% of grate surface inletting capacity.	Grate free of trash and debris.
	Damaged or Missing	Grate missing or broken member(s) of the grate.	Grate is in place and meets design standards.

**5.A.7 Maintenance Criteria for Debris Barriers (e.g., Trash Racks)**

**Table 5.41: Maintenance Criteria for Debris Barriers (e.g., Trash Racks)**

Maintenance Components	Defect	Condition When Maintenance Is Needed	Results Expected When Maintenance Is Performed
General	Trash and Debris	Trash or debris that is plugging > 20% of the openings in the barrier.	Barrier cleared to design flow capacity.
Metal	Damaged/Missing Bars	Bars are bent out of shape > 3 inches.	Bars in place with no bends > 0.75 inches.
		Bars are missing or entire barrier missing.	Bars in place according to design.
		Bars are loose and rust is causing 50% deterioration to any part of barrier.	Barrier replaced or repaired to design standards.
	Inlet/Outlet Pipe	Debris barrier missing or not attached to pipe	Barrier firmly attached to pipe

## 5.A.8 Maintenance Criteria for Energy Dissipaters

**Table 5.42: Maintenance Criteria for Energy Dissipaters**

Maintenance Components	Defect	Conditions When Maintenance Is Needed	Results Expected When Maintenance Is Performed
<b>External</b>			
Rock Pad	Missing or Moved Rock	Only one layer of rock exists above native soil in area $\geq 5$ square feet (sf), or any exposure of native soil.	Rock pad replaced to design standards.
	Erosion	Soil erosion in or adjacent to rock pad.	Rock pad replaced to design standards.
Dispersion Trench	Pipe Plugged With Sediment	Accumulated sediment > 20% of the design depth.	Pipe cleaned/flushed so that it matches design.
	Not Discharging Water Properly	Visual evidence of water discharging at concentrated points along trench (normal condition is a "sheet flow" of water along trench). Intent is to prevent erosion damage.	Trench redesigned or rebuilt to standards.
	Perforations Plugged	> 50% of the perforations in pipe are plugged with debris and sediment.	Perforated pipe cleaned or replaced.
	Water Flowing out Top of "Distributor" Catch Basin	Maintenance person observes or receives credible report of water flowing out during any storm less than the design storm or is causing or appears likely to cause damage.	Energy dissipater rebuilt or redesigned to standards.
	Receiving Area Oversaturated	Water in receiving area is causing or has potential of causing landslide problems.	No danger of landslides.
<b>Internal</b>			
Manhole/ Chamber	Worn or Damaged Post, Baffles, or Side of Chamber	Structure dissipating flow deteriorates to one-half the original size or any concentrated worn spot > 1 sf, which would make structure unsound.	Structure replaced to design standards.
	Other Defects	See criteria in <a href="#">Table 5.40: Maintenance Criteria for Catch Basins</a> .	See criteria in <a href="#">Table 5.40: Maintenance Criteria for Catch Basins</a> .

## 5.A.9 Maintenance Criteria for Biofiltration Swales

**Table 5.43: Maintenance Criteria for Biofiltration Swales**

Maintenance Component	Defect or Problem	Condition When Maintenance Is Needed	Recommended Maintenance to Correct Problem
General	Sediment Accumulation on Grass	Sediment depth > 2 inches.	Remove sediment deposits on grass treatment area of the biofiltration swale. When finished, swale should be level from side to side and drain freely toward outlet. There should be no areas of standing water once inflow has ceased.
	Standing Water	When water stands in the swale between storms and does not drain freely.	Any of the following may apply: remove sediment or trash blockages, improve grade from head to foot of swale, remove clogged check dams, add underdrains or convert to a wet biofiltration swale.
	Flow Spreader	Flow spreader uneven or clogged so that flows are not uniformly distributed through entire swale width.	Level the spreader and clean so that flows are spread evenly over entire swale width.
	Constant Base Flow	When small quantities of water continually flow through the swale, even when it has been dry for weeks, and an eroded, muddy channel has formed in the swale bottom.	Add a low-flow pea-gravel drain the length of the swale or by-pass the base flow around the swale.
	Poor Vegetation Coverage	When grass is sparse or bare or eroded patches occur in > 10% of the swale bottom.	Determine why grass growth is poor and correct that condition. Replant with plugs of grass from the upper slope: plant in the swale bottom at 8-inch intervals. Or reseed into loosened, fertile soil.

**Table 5.43: Maintenance Criteria for Biofiltration Swales (continued)**

Maintenance Component	Defect or Problem	Condition When Maintenance Is Needed	Recommended Maintenance to Correct Problem
	Vegetation	When the grass becomes excessively tall (> 10 inches); when nuisance weeds and other vegetation start to take over.	Mow vegetation or remove nuisance vegetation so that flow not impeded. Grass should be mowed to a height of 3 to 4 inches. Remove grass clippings.
	Excessive Shading	Grass growth is poor because sunlight does not reach swale.	If possible, trim back overhanging limbs and remove brushy vegetation on adjacent slopes.
	Inlet/Outlet	Inlet/outlet areas clogged with sediment and/or debris.	Remove material so that there is no clogging or blockage in the inlet and outlet area.
	Trash and Debris Accumulation	Trash and debris accumulated in the biofiltration swale.	Remove trash and debris from biofiltration swale.
	Erosion/ Scouring	Eroded or scoured swale bottom due to flow channelization, or higher flows.	For ruts or bare areas < 12 inches wide, repair the damaged area by filling with crushed gravel. If bare areas are large, generally > 12 inches wide, the swale should be regraded and reseeded. For smaller bare areas, overseed when bare spots are evident, or take plugs of grass from the upper slope and plant in the swale bottom at 8-inch intervals.

**5.A.10 Maintenance Criteria for Vegetated Filter Strips**

**Table 5.44: Maintenance Criteria for Vegetated Filter Strips**

Maintenance Component	Defect or Problem	Condition When Maintenance Is Needed	Recommended Maintenance to Correct Problem
General	Sediment Accumulation on Grass	Sediment depth > 2 inches.	Remove sediment deposits, relevel so slope is even and flows pass evenly through strip.
	Vegetation	When the grass becomes excessively tall (> 10 inches); when nuisance weeds and other vegetation starts to take over.	Mow grass, control nuisance vegetation, such that flow not impeded. Grass should be mowed to a height between 3 to 4 inches.
	Trash and Debris Accumulation	Trash and debris accumulated on the filter strip.	Remove trash and debris from filter.
	Erosion/ Scouring	Eroded or scoured areas due to flow channelization, or higher flows.	For ruts or bare areas < 12 inches wide, repair the damaged area by filling with crushed gravel. The grass will creep in over the rock in time. If bare areas are large, generally > 12 inches wide, the filter strip should be regraded and reseeded. For smaller bare areas, overseed when bare spots are evident.
	Flow Spreader	Flow spreader uneven or clogged so that flows are not uniformly distributed through entire filter width.	Level the spreader and clean so that flows are spread evenly over entire filter width.



### 5.A.11 Maintenance Criteria for Wetvaults

**Table 5.45: Maintenance Criteria for Wetvaults**

Maintenance Component	Defect	Condition When Maintenance Is Needed	Results Expected When Maintenance Is Performed
General	Trash/Debris Accumulation	Trash and debris accumulated in vault, pipe or inlet/outlet (includes floatables and nonfloatables).	Remove trash and debris from vault.
	Sediment Accumulation in Vault	Sediment accumulation in vault bottom exceeds the depth of the sediment zone plus 6 inches.	Remove sediment from vault.
	Damaged Pipes	Inlet/outlet piping damaged or broken and in need of repair.	Pipe repaired or replaced.
	Access Cover Damaged/ Not Working	Cover cannot be opened or removed, especially by one person.	Pipe repaired or replaced to proper working specifications.
	Ventilation	Ventilation area blocked or plugged.	Blocking material removed or cleared from ventilation area. A specified percentage of the vault surface area must provide ventilation to the vault interior (see design specifications).
	Vault Structure Damage – Includes Cracks in Walls, Cracks in Bottom, or Damage to Frame and/or Top Slab	Maintenance/inspection personnel determine that the vault is not structurally sound.	Vault replaced or repairs made so that vault meets design specifications and is structurally sound.
		Cracks > 0.5 inches at the joint of any inlet/outlet pipe or evidence of soil particles entering through the cracks.	Vault repaired so that no cracks exist > 0.25 inches at the joint of the inlet/outlet pipe.
	Baffles	Baffles corroding, cracking, warping and/or showing signs of failure as determined by maintenance/inspection staff.	Baffles repaired or replaced to specifications.
Access Ladder Damage	Ladder is corroded or deteriorated, not functioning properly, not attached to structure wall, missing rungs, has cracks and/or misaligned. Confined space warning sign missing.	Ladder replaced or repaired to specifications, and is safe to use as determined by inspection personnel. Replace sign warning of confined space entry requirements. Ladder and entry notification complies with Occupational Safety and Health Administration standards.	

### 5.A.12 Maintenance Criteria for Sand Filters (Aboveground/Open)

**Table 5.46: Maintenance Criteria for Sand Filters (Aboveground/Open)**

Maintenance Component	Defect	Condition When Maintenance Is Needed	Results Expected When Maintenance Is Performed
Aboveground (Open Sand Filter)	Sediment Accumulation on Top Layer	Sediment depth > 0.5 inches.	No sediment deposit on grass layer of sand filter that would impede permeability of the filter section.
	Trash and Debris Accumulations	Trash and debris accumulated on sand filter bed.	Trash and debris removed from sand filter bed.
	Sediment/ Debris in Clean-Outs	When the clean-outs become full or partially plugged with sediment and/or debris.	Sediment removed from clean-outs.
	Sand Filter Media	Drawdown of water through the sand filter media takes longer than 24 hours, and/or flow through the overflow pipes occurs frequently.	Top several inches of sand are scraped. May require replacement of entire sand filter depth depending on extent of plugging (a sieve analysis is helpful to determine if the lower sand has too high a proportion of fine material).
	Prolonged Flows	Sand is saturated for prolonged periods of time (several weeks) and does not dry out between	Low, continuous flows are limited to a small portion of the sand filter by using a low wooden divider or slightly

**Table 5.46: Maintenance Criteria for Sand Filters (Aboveground/Open) (continued)**

Maintenance Component	Defect	Condition When Maintenance Is Needed	Results Expected When Maintenance Is Performed
		storms due to continuous base flow or prolonged flows from detention Best Management Practices (BMPs).	depressed sand surface.
	Short Circuiting	When flows become concentrated over one section of the sand filter rather than dispersed.	Flow and percolation of water through sand filter is uniform and dispersed across the entire filter area.
	Erosion Damage to Slopes	Erosion > 2 inches deep where cause of damage is prevalent or potential for continued erosion is evident.	Slopes stabilized using proper erosion control measures.
	Rock Pad Missing or out of Place	Soil beneath the rock is visible.	Rock pad replaced or rebuilt to design specifications.
	Flow Spreader	Flow spreader uneven or clogged so that flows are not uniformly distributed across sand filter.	Spreader leveled and cleaned so that flows are spread evenly over sand filter.
	Damaged Pipes	Any part of the piping that is crushed or deformed > 20% or any other failure to the piping.	Pipe repaired or replaced.

**5.A.13 Maintenance Criteria for Sand Filters (Belowground/Enclosed)**

**Table 5.47: Maintenance Criteria for Sand Filters (Belowground/Enclosed)**

Maintenance Component	Defect	Condition When Maintenance Is Needed	Results Expected When Maintenance Is Performed
Belowground Vault	Sediment Accumulation on Sand Media Section	Sediment depth > 0.5 inches.	No sediment deposits on sand filter section that would impede permeability of the filter section.
	Sediment Accumulation in Presettling Portion of Vault	Sediment accumulation in vault bottom exceeds the depth of the sediment zone plus 6 inches.	No sediment deposits in first chamber of vault.
	Trash/Debris Accumulation	Trash and debris accumulated in vault, or pipe inlet/outlet, floatables and nonfloatables.	Trash and debris removed from vault and inlet/outlet piping.
	Sediment in Drain Pipes/ Clean-Outs	When drain pipes, clean-outs become full with sediment and/or debris.	Sediment and debris removed.
	Short Circuiting	When seepage/flow occurs along the vault walls and corners. Sand eroding near inflow area.	Sand filter media section relaid and compacted along perimeter of vault to form a semiseal. Erosion protection added to dissipate force of incoming flow and curtail erosion.
	Damaged Pipes	Inlet or outlet piping damaged or broken and in need of repair.	Pipe repaired and/or replaced.
	Access Cover Damaged/Not Working	Cover cannot be opened, corrosion/deformation of cover. Maintenance person cannot remove cover using normal lifting pressure.	Cover repaired to proper working specifications or replaced.
	Ventilation	Ventilation area blocked or plugged	Blocking material removed or cleared from ventilation area. A specified percentage of the vault surface area must provide ventilation to the vault interior (see design specifications).
	Vault Structure Damaged; Includes Cracks in Walls, Cracks in Bottom, or Damage to Frame and/or Top Slab	Cracks > 0.5 inches or evidence of soil particles entering the structure through the cracks, or maintenance/inspection personnel determine that the vault is not structurally sound. Cracks > 0.5 inches at the joint of any inlet/outlet pipe or evidence of soil particles entering through the cracks.	Vault replaced or repairs made so that vault meets design specifications and is structurally sound. Vault repaired so that no cracks exist > 0.25 inches at the joint of the inlet/outlet pipe.

**Table 5.47: Maintenance Criteria for Sand Filters (Belowground/Enclosed) (continued)**

Maintenance Component	Defect	Condition When Maintenance Is Needed	Results Expected When Maintenance Is Performed
	Baffles/ Internal Walls	Baffles or walls corroding, cracking, warping and/or showing signs of failure as determined by maintenance/inspection person.	Baffles repaired or replaced to specifications.
	Access Ladder Damaged	Ladder is corroded or deteriorated, not functioning properly, not securely attached to structure wall, missing rungs, cracks, and misaligned.	Ladder replaced or repaired to specifications, and is safe to use as determined by inspection personnel.

**5.A.14 Maintenance Criteria for Media Filters**

**Table 5.48: Maintenance Criteria for Media Filters**

Maintenance Component	Defect	Condition When Maintenance Is Needed	Results Expected When Maintenance Is Performed
Belowground Vault	Sediment Accumulation on Media	Sediment depth > 0.25 inches.	No sediment deposits that would impede permeability of the media.
	Sediment Accumulation in Vault	Sediment depth > 6 inches in first chamber.	No sediment deposits in vault bottom of first chamber.
	Trash/Debris Accumulation	Trash and debris accumulated on filter bed.	Trash and debris removed from the filter bed.
	Sediment in Drain Pipes/ Clean-Outs	When drain pipes, clean-outs, become full with sediment and/or debris.	Sediment and debris removed.
	Damaged Pipes	Any part of the pipes that are crushed or damaged due to corrosion and/or settlement.	Pipe repaired and/or replaced.
	Access Cover Damaged/ Not Working	Cover cannot be opened; one person cannot open the cover using normal lifting pressure, corrosion/deformation of cover.	Cover repaired to proper working specifications or replaced.
	Vault Structure – Includes Cracks in Wall, Cracks in Bottom, or Damage to Frame and/or Top Slab	Cracks > 0.5 inches or evidence of soil particles entering the structure through the cracks, or maintenance/inspection personnel determine that the vault is not structurally sound.	Vault replaced or repairs made so that vault meets design specifications and is structurally sound.
		Cracks > 0.5 inches at the joint of any inlet/outlet pipe or evidence of soil particles entering through the cracks.	Vault repaired so that no cracks exist > 0.25 inches at the joint of the inlet/outlet pipe.
	Baffles	Baffles corroding, cracking warping, and/or showing signs of failure as determined by maintenance/inspection person.	Baffles repaired or replaced to specifications.
Access Ladder Damaged	Ladder is corroded or deteriorated, not functioning properly, not securely attached to structure wall, missing rungs, cracks, and misaligned.	Ladder replaced or repaired and meets specifications, and is safe to use as determined by inspection personnel.	
Belowground Cartridge Type	Filter Media	Drawdown of water through the media takes > 1 hour, and/or overflow occurs frequently.	Media cartridges replaced.
	Short Circuiting	Flows do not properly enter filter cartridges.	Filter cartridges replaced.

## 5.A.15 Maintenance Criteria for Baffle Oil and Water Separators (API Type)

**Table 5.49: Maintenance Criteria for Baffle Oil and Water Separators (API Type)**

Maintenance Component	Defect	Condition When Maintenance Is Needed	Results Expected When Maintenance Is Performed	
General	Monitoring	Inspection of discharge water for obvious signs of poor water quality.	Effluent discharge from vault should be clear without thick visible sheen.	
	Sediment Accumulation	Sediment depth in bottom of vault > 6 inches in depth.	No sediment deposits on vault bottom that would impede flow through the vault and reduce separation efficiency.	
	Trash and Debris Accumulation	Trash and debris accumulation in vault, or pipe inlet/outlet, floatables and nonfloatables.	Trash and debris removed from vault, and inlet/outlet piping.	
	Oil Accumulation	Oil accumulations > 1 inch, at the surface of the water.	Extract oil from vault by Vactoring. Disposal in accordance with state and local rules and regulations.	
	Damaged Pipes	Inlet or outlet piping damaged or broken and in need of repair.	Pipe repaired or replaced.	
	Access Cover Damaged/ Not Working	Cover cannot be opened, corrosion/deformation of cover.	Cover repaired to proper working specifications or replaced.	
	Vault Structure Damage – Includes Cracks in Walls, Cracks in Bottom, or Damage to Frame and/or Top Slab	See “Catch Basins” ( <a href="#">Table 5.40: Maintenance Criteria for Catch Basins</a> )		Vault replaced or repairs made so that vault meets design specifications and is structurally sound.
		Cracks > 0.5 inches at the joint of any inlet/outlet pipe or evidence of soil particles entering through the cracks.		Vault repaired so that no cracks exist > 0.25 inches at the joint of the inlet/outlet pipe.
	Baffles	Baffles corroding, cracking, warping and/or showing signs of failure as determined by maintenance/inspection person.	Baffles repaired or replaced to specifications.	
Access Ladder Damaged	Ladder is corroded or deteriorated, not functioning properly, not securely attached to structure wall, missing rungs, cracks, and misaligned.	Ladder replaced or repaired and meets specifications, and is safe to use as determined by inspection personnel.		

## 5.A.16 Maintenance Criteria for Coalescing Plate Oil and Water Separators

**Table 5.50: Maintenance Criteria for Coalescing Plate Oil and Water Separators**

Maintenance Component	Defect	Condition When Maintenance Is Needed	Results Expected When Maintenance Is Performed	
General	Monitoring	Inspection of discharge water for obvious signs of poor water quality.	Effluent discharge from vault should be clear with no thick visible sheen.	
	Sediment Accumulation	Sediment depth in bottom of vault > 6 inches in depth and/or visible signs of sediment on plates.	No sediment deposits on vault bottom and plate media, which would impede flow through the vault and reduce separation efficiency.	
	Trash and Debris Accumulation	Trash and debris accumulated in vault, or pipe inlet/outlet, floatables and nonfloatables.	Trash and debris removed from vault and inlet/outlet piping.	
	Oil Accumulation	Oil accumulation > 1 inch at the water surface.	Oil is extracted from vault using Vactoring methods. Coalescing plates are cleaned by thoroughly rinsing and flushing. Should be no visible oil depth on water.	
	Damaged Coalescing Plates	Plate media broken, deformed, cracked and/or showing signs of failure.	A portion of the media pack or the entire plate pack is replaced depending on severity of failure.	
	Damaged Pipes	Inlet or outlet piping damaged or broken and in need of repair.	Pipe repaired and or replaced.	
	Baffles	Baffles corroding, cracking, warping and/or showing signs of failure as determined by maintenance/inspection person.	Baffles repaired or replaced to specifications.	
	Vault Structure Damage – Includes Cracks in Walls, Cracks in Bottom, or Damage to Frame and/or Top Slab	Cracks > 0.5 inches or evidence of soil particles entering the structure through the cracks, or maintenance/inspection personnel determine that the vault is not structurally sound.		Vault replaced or repairs made so that vault meets design specifications and is structurally sound.
		Cracks > 0.5 inches at the joint of any inlet/outlet pipe or evidence of soil particles entering through the cracks.		Vault repaired so that no cracks exist > 0.25 inches at the joint of the inlet/outlet pipe.
Access Ladder Damaged	Ladder is corroded or deteriorated, not functioning properly, not securely attached to structure wall, missing rungs, cracks, and misaligned.		Ladder replaced or repaired and meets specifications, and is safe to use as determined by inspection personnel.	

## 5.A.17 Maintenance Criteria for Catch Basin Inserts

**Table 5.51: Maintenance Criteria for Catch Basin Inserts**

Maintenance Component	Defect	Conditions When Maintenance Is Needed	Results Expected When Maintenance Is Performed
General	Sediment Accumulation	When sediment forms a cap over the insert media of the insert and/or unit.	No sediment cap on the insert media and its unit.
	Trash and Debris Accumulation	Trash and debris accumulates on insert unit creating a blockage/restriction.	Trash and debris removed from insert unit. Runoff freely flows into catch basin.
	Media Insert Not Removing Oil	Effluent water from media insert has a visible sheen.	Effluent water from media insert is free of oils and has no visible sheen.
	Media Insert Water Saturated	Catch basin insert is saturated with water and no longer has the capacity to absorb.	Remove and replace media insert
	Media Insert Oil Saturated	Media oil saturated due to petroleum spill that drains into catch basin.	Remove and replace media insert.
	Media Insert Use Beyond Normal Product Life	Media has been used beyond the typical average life of media insert product.	Remove and replace media at regular intervals, depending on insert product.

## 5.A.18 Maintenance Criteria for Bioretention

**Table 5.52: Maintenance Criteria for Bioretention**

Maintenance Component	Activity	Objective	Schedule	Notes
<b>Routine Maintenance</b>				
Vegetation	Maintain drip irrigation system without breaks or blockages. Hand water as needed for specific plants.	Establish vegetation with a minimum 80% survival rate	Twice annually (May and July) or as indicated by plant health	Plants should be selected to be drought tolerant and not require watering after establishment (2 to 3 years). Watering may be required during prolonged dry periods after plants are established.
	Remove and/or prune vegetation	Maintain adequate plant coverage and plant health. Reduce shading of understory if species require sun. Maintain soil health and infiltration capability. Maintain clearances from utilities and sight distances.	Once or twice annually	Depending on aesthetic requirements, occasional pruning and removing dead plant material may be necessary.
	Remove undesired vegetation by hand weeding.	Reduce competition for desired vegetation. Improve aesthetics.	Prior to major weed species disbursing seeds (usually twice annually)	Periodic weeding is necessary until plants are established. The weeding schedule should become less frequent if the appropriate plant species and planting density have been used and, as a result, undesirable plants excluded.
Curb cuts	Remove any accumulation of debris from gutter and entrance to bioretention area.	Maintain proper flow of stormwater from paved/ impervious areas to bioretention BMP.	Twice annually (October and January)	
Mulch	Replace or add mulch with hand tools to a depth of 2 to 3 inches.	Replenish organic material in soil, reduce erosion, prolong good soil moisture level, and filter pollutants.	Once annually or every 2 years	Consider replacing mulch annually in bioretention BMPs where high pollutant loading is likely (e.g., contributing areas that include quick marts). Use compost in the bottom of the BMP and wood chips on side slopes and rim (above typical water levels).
General	Trash removal	Maintain aesthetics and prevent clogging of infrastructure.	Twice annually	
<b>Nonroutine Maintenance</b>				
Inlets/ Outlets	Clear vegetation within 1 foot of inlets and outlets to maintain access pathways.	Prevent clogging of infrastructure and maintain sight lines and access for inspections.	Once annually	If sediment is deposited in the bioretention area, immediately determine the source within the contributing area and stabilize.
Bioretention Area	Shovel or rake out sediment within vegetated areas. Vacuum catch basins or other sediment structures.	Reduce sediment transport and clogging of infrastructure. Maintain desired plant survival and appearance of the BMP. Maintain proper elevations and ponding depths.	Determined by inspection	
Underdrains	Jet clean or rotary cut debris/roots from underdrains.	Maintain proper subsurface drainage, ponding depths, and dewatering rates.	Determined by inspection of clean-outs	Bioretention BMPs should be designed with a proper elevation drop from pavement to vegetated area to prevent blockage of storm flows by vegetation into infiltration area.
Vegetation	Reseed or replant bare spots or poorly performing plants.	Maintain dense vegetation cover to prevent erosion, encourage infiltration and exclude unwanted weed species.	Determined by inspection	Soil mixes for bioretention BMPs are designed to maintain long-term fertility and pollutant processing capability. Estimates from metal attenuation research suggest that metal accumulation should not present an environmental concern for at least 20 years in bioretention systems. Replacing mulch in bioretention BMPs where heavy metal and hydrocarbon deposition is likely provides additional of protection for prolonged performance.

**Table 5.52: Maintenance Criteria for Bioretention (continued)**

Maintenance Component	Activity	Objective	Schedule	Notes
Soil Medium	Remove vegetation (save as much plant material as possible for replanting) and excavated soil with backhoe, excavator or, if small BMP, by hand.	Replace soil medium to maintain infiltration, soil fertility, and pollutant removal capability	Determined by inspection (visual, infiltration, pollutant, and soil fertility tests)	
General	Remove excess vegetation at the intersection of pavement and vegetation with a line trimmer, vacuum sweeper, rake or shovel.	Prevent accumulation of vegetation at pavement edge and maintain proper sheet flow of stormwater from paved/impervious areas to bioretention BMP.	Determined by inspection	If specific plants have a high mortality rate, assess the cause and replace with appropriate species.
	Various activities to maintain walls, intake and outfall pads, weirs, and other hardscape elements.	Rebuild or reinforce structures to maintain proper drainage and aesthetics and prevent erosion.	Determined by inspection	
	Maintain proper slope with hand tools, back hoe, or excavator; replant exposed areas.	Regrade or recontour side slopes to prevent erosion where side slopes have been disturbed by foot or vehicle intrusion.	Determined by inspection	

**5.A.19 Maintenance Criteria for Media Filter Drains (MFDs)**

**Table 5.53: Maintenance Criteria for Media Filter Drains (MFDs)**

Maintenance Component	Defect	Condition When Maintenance Is Needed	Results Expected When Maintenance Is Performed
General	Sediment Accumulation on Grass Filter Strip	Sediment depth > 2 inches or creates uneven grading that interferes with sheet flow.	Remove sediment deposits on grass treatment area of the embankment. When finished, embankment should be level from side to side and drain freely toward the toe of the embankment slope. There should be no areas of standing water once inflow has ceased.
	No-Vegetation Zone/ Flow Spreader	Flow spreader is uneven or clogged so that flows are not uniformly distributed over entire embankment width.	Level the spreader and clean to spread flows evenly over entire embankment width.
	Poor Vegetation Coverage	Grass is sparse or bare, or eroded patches are observed in > 10% of the grass strip surface area.	Determine why grass growth is poor and correct the offending condition. Reseed into loosened, fertile soil or compost; or, replant with plugs of grass from the upper slope.
	Vegetation	Grass becomes excessively tall (> 10 inches); nuisance weeds and other vegetation start to take over.	Mow vegetation or remove nuisance vegetation to not impede flow. Mow grass to a height of 6 inches.
	Media Filter Drain Mix Replacement	Water is seen on the surface of the media filter drain mix long after the storms have ceased. Typically, the 6-month, 24-hour precipitation event should drain within 48 hours. More common storms should drain within 24 hours. Maintenance also needed on a 10-year cycle and during a preservation project.	Excavate and replace all of the media filter drain mix contained within the media filter drain.
	Excessive Shading	Grass growth is poor because sunlight does not reach embankment.	If possible, trim back overhanging limbs and remove brushy vegetation on adjacent slopes.
	Trash and	Trash and debris have accumulated on embankment.	Remove trash and debris from embankment.

**Table 5.53: Maintenance Criteria for Media Filter Drains (MFDs) (continued)**

Maintenance Component	Defect	Condition When Maintenance Is Needed	Results Expected When Maintenance Is Performed
	Debris		
	Flooding of Media Filter Drain	When media filter drain is inundated by floodwater.	Evaluate media filter drain material for acceptable infiltration rate and replace if media filter drain does not meet long-term infiltration rate standards.

**5.A.20 Maintenance Criteria for Compost-Amended Vegetated Filter Strip (CAVFS)**

**Table 5.54: Maintenance Criteria for Compost-Amended Vegetated Filter Strip (CAVFS)**

Maintenance Component	Defect	Condition When Maintenance Is Needed	Results Expected When Maintenance Is Performed
General	Sediment Accumulation on Grass	Sediment depth > 2 inches.	Remove sediment deposits. Relevel so slope is even and flows pass evenly through strip.
	Vegetation	Grass becomes excessively tall (> 10 inches); nuisance weeds and other vegetation start to take over.	Mow grass and control nuisance vegetation so that flow is not impeded. Grass should be mowed to a height of 6 inches.
	Trash and Debris	Trash and debris have accumulated on the vegetated filter strip.	Remove trash and debris from filter.
	Erosion/ Scouring	Areas have eroded or scoured due to flow channelization or high flows.	For ruts or bare areas < 12 inches wide, repair the damaged area by filling with a 50/50 mixture of crushed gravel and compost. The grass will creep in over the rock in time. If bare areas are large, generally > 12 inches wide, the vegetated filter strip should be regraded and reseeded. For smaller bare areas, overseed when bare spots are evident.
	Flow Spreader	Flow spreader is uneven or clogged so that flows are not uniformly distributed over entire filter width.	Level the spreader and clean so that flows are spread evenly over entire filter width.



## Appendix 5-B: Planting Recommendations

### 5.B.1 Introduction

This appendix summarizes planting recommendations for the following Best Management Practices (BMPs):

- [BMP T5.10: Infiltration Ponds](#)
- [BMP T5.20: Infiltration Trenches](#)
- [BMP T5.21: Infiltration Swales](#)
- [BMP T5.30: Bioinfiltration Swales](#)
- [BMP T5.31: Bioretention](#)
- [BMP T5.70: Basic Wetpond](#)
- [BMP T5.71: Large Wetpond](#)
- [BMP T5.73: Stormwater Treatment Wetland](#)
- [BMP T5.74: Large Extended Detention Dry Pond](#)
- [BMP T5.90: Evaporation Ponds](#)

Recommendations for permanent seeding mixes are provided in [Chapter 7 - Construction Stormwater Pollution Prevention](#), and their applicability to runoff treatment Best Management Practices (BMPs) is discussed in [5.B.2 Seeding Recommendations](#). Detailed planting recommendations for bioretention ([BMP T5.31: Bioretention](#)) are provided in [5.B.3 Bioretention Planting Recommendations](#). Detailed planting recommendations for stormwater treatment wetlands ([BMP T5.73: Stormwater Treatment Wetland](#)) are provided in [5.B.4 Stormwater Treatment Wetlands Plant List](#).

Detailed recommendations have not been provided for vegetated roofs ([BMP F6.63: Vegetated Roofs](#)); however, designers should select plants that:

- Cover and anchor the substrate surface relatively quickly,
- Form a self-repairing mat,
- Take up and transpire the available/retained water, and
- Survive the extreme climatic conditions (cold hardy, drought-tolerant, and wind-tolerant).

Eastern Washington has many good native and highly adapted plant choices that are appropriate to vegetated roof settings. These plant choices are tolerant of the extreme climatic conditions that exist. For extensive roof designs, designers should consider selecting naturally occurring plant species that survive with little to no input. Meadow-like bunchgrass mixes and desert shrub-steppe plants may also be appropriate in some settings of eastern Washington.

## 5.B.2 Seeding Recommendations

Seeding recommendations are in [BMP C120E: Temporary and Permanent Seeding](#).

**Table 5.55: Recommended Seeding Mixes for Runoff Treatment BMPs**

BMP	Table Title(s)
<a href="#">BMP T5.10: Infiltration Ponds</a>	<a href="#">Table 7.11: Permanent Seed Mixes: Grassed Waterways With More Than 18 Inches Precipitation</a>
<a href="#">BMP T5.20: Infiltration Trenches</a>	<ul style="list-style-type: none"> <li>• <a href="#">Table 7.10: Permanent Seed Mixes: Grassed Waterways With 15 to 18 Inches Precipitation</a></li> <li>• <a href="#">Table 7.11: Permanent Seed Mixes: Grassed Waterways With More Than 18 Inches Precipitation</a></li> </ul>
<a href="#">BMP T5.21: Infiltration Swales</a>	<ul style="list-style-type: none"> <li>• <a href="#">Table 7.9: Permanent Seed Mixes: Grassed Waterways With Fewer Than 15 Inches Precipitation</a></li> <li>• <a href="#">Table 7.10: Permanent Seed Mixes: Grassed Waterways With 15 to 18 Inches Precipitation</a></li> </ul>
<a href="#">BMP T5.30: Bioinfiltration Swales</a>	<ul style="list-style-type: none"> <li>• <a href="#">Table 7.9: Permanent Seed Mixes: Grassed Waterways With Fewer Than 15 Inches Precipitation</a></li> <li>• <a href="#">Table 7.10: Permanent Seed Mixes: Grassed Waterways With 15 to 18 Inches Precipitation</a></li> </ul>
<a href="#">BMP T5.31: Bioretention</a> – Zone 1	<ul style="list-style-type: none"> <li>• <a href="#">Table 7.7: Permanent Seed Mixes: Upland Areas With 18 to 24 Inches Precipitation</a></li> <li>• <a href="#">Table 7.8: Permanent Seed Mixes: Upland Areas With More Than 24 Inches Precipitation</a></li> </ul>
<a href="#">BMP T5.31: Bioretention</a> – Zone 2	<ul style="list-style-type: none"> <li>• <a href="#">Table 7.4: Permanent Seed Mixes: Upland Areas with Less than 12 Inches Precipitation</a></li> <li>• <a href="#">Table 7.5: Permanent Seed Mixes: Upland Areas That Receive 12 to 15 Inches Precipitation</a></li> </ul>
<a href="#">BMP T5.71: Large Wetpond</a>	<a href="#">Table 7.8: Permanent Seed Mixes: Upland Areas With More Than 24 Inches Precipitation</a>
<a href="#">BMP T5.73: Stormwater Treatment Wetland</a>	<ul style="list-style-type: none"> <li>• <a href="#">Table 7.5: Permanent Seed Mixes: Upland Areas That Receive 12 to 15 Inches Precipitation</a></li> <li>• <a href="#">Table 7.7: Permanent Seed Mixes: Upland Areas With 18 to 24 Inches Precipitation</a></li> <li>• <a href="#">Table 7.8: Permanent Seed Mixes: Upland Areas With More Than 24 Inches Precipitation</a></li> </ul>
<a href="#">BMP T5.74: Large Extended Detention Dry Pond</a>	<ul style="list-style-type: none"> <li>• <a href="#">Table 7.4: Permanent Seed Mixes: Upland Areas with Less than 12 Inches Precipitation</a></li> <li>• <a href="#">Table 7.5: Permanent Seed Mixes: Upland Areas That</a></li> </ul>

**Table 5.55: Recommended Seeding Mixes for Runoff Treatment BMPs (continued)**

BMP	Table Title(s)
	<a href="#">Receive 12 to 15 Inches Precipitation</a>
<a href="#">BMP T5.90: Evaporation Ponds</a>	<ul style="list-style-type: none"> <li>• <a href="#">Table 7.7: Permanent Seed Mixes: Upland Areas With 18 to 24 Inches Precipitation</a></li> <li>• <a href="#">Table 7.8: Permanent Seed Mixes: Upland Areas With More Than 24 Inches Precipitation</a></li> </ul>

### 5.B.3 Bioretention Planting Recommendations

This section is intended to provide guidance for the selection of trees, shrubs, grasses, perennials, wildflowers, and ground cover for bioretention BMPs. The plant list contains both native and nonnative species that are well suited for planting bioretention Planting Zone 1 and/or Zone 2.

This is not an exhaustive list. There are likely plants not listed here which would be particularly well suited to the climatic and physiographical conditions of an eastern Washington bioretention BMP. Rather this list is intended to form the basis for low impact development (LID) plant selection in the region, and should be amended, as appropriate, over time. Project proponents should also check with local jurisdictions to determine if local planting lists are available.

The list is organized by scientific name but also includes information identifying the climate zones (see [Figure 4.1: Average Annual Precipitation and Climate Regions](#)) and bioretention planting zones (see [Figure 5.30: Bioretention Soil Moisture Zones](#)) applicable to each planting. Each plant listing includes the following information:

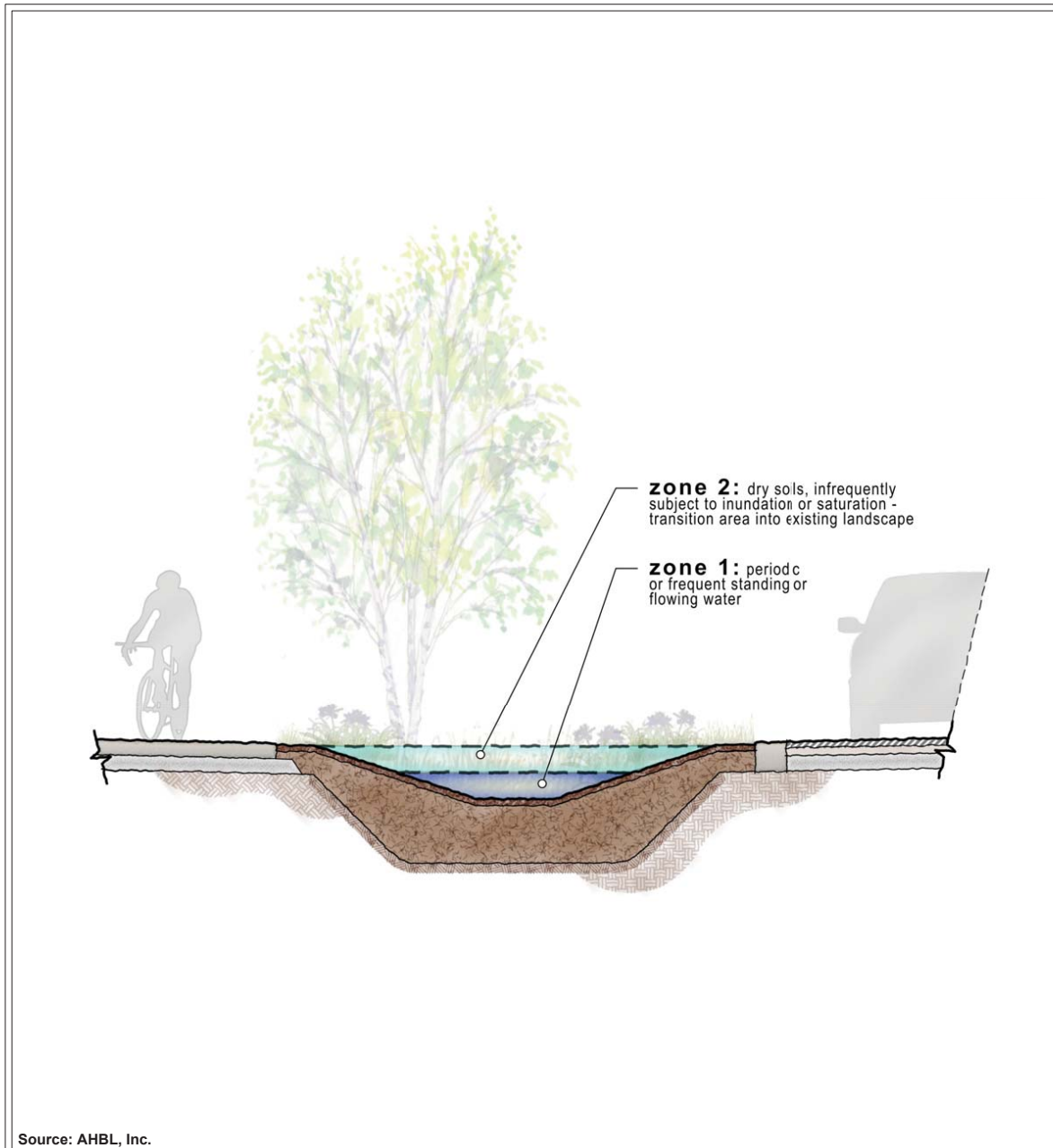
- Scientific name
- Common name
- Bioretention zones
- Climate Region (see [4.3.1 Climate Regions](#))
- Notes

In bioretention BMPs, soil surface is sloped, resulting in differing planting conditions across the structure (Bioretention Planting Zones 1 and 2). Plants located at the bottom where ponding occurs, must be able to tolerate periodic stormwater inundation and will have different requirements than those placed on the side slopes, which receive runoff, but not ponding. Designers should also consider local jurisdiction requirements for maximum height, overhang, and sight distance where applicable. An example planting scheme for a bioretention swale in Spokane is provided as [Figure 5.31: Example Planting Scheme for a Bioretention Swale in Spokane](#).

When selecting any plant species for LID projects, designers should consider xeriscape practices. Xeriscaping is a landscaping or gardening practice that focuses on efficient irrigation practices,

grouping plants together with the same soil, water, and sunlight requirements, and minimizing the need for fertilizers and pesticides.

**Figure 5.30: Bioretention Soil Moisture Zones**



Source: AHBL, Inc.



## Bioretention Soil Moisture Zones


Revised June 2013

Please see <http://www.ecy.wa.gov/copyright.html> for copyright notice including permissions, limitation of liability, and disclaimer.

**Figure 5.31: Example Planting Scheme for a Bioretention Swale in Spokane**

## POTENTIAL PLANTING SCHEMES

**Palette 1**



- *Deschampsia caespitosa* 'Northern Lights' - Tufted Hair Grass
- *Rudbeckia fulgida* 'Goldsturm' - Black-eyed Susan
- *Lobelia cardinalis* - Cardinal flower
- *Alchemilla mollis* - Lady's Mantle


**Palette 2**




- *Symphoricarpos albus* - Snowberry
- *Carex elata* 'Bowles Golden' - Golden Sedge
- *Rudbeckia fulgida* 'Goldsturm' - Black-eyed Susan
- *Mahonia repens* - Creeping mahonia

**Potential Street Trees**


1



2



3



1. *Liquidambar styraciflua* - Sweetgum
2. *Carpinus betulus* 'Fastigiata' - Pyramidal European Hornbeam
3. *Nyssa sylvatica* - Sourgum

Source: AHBL, Inc.



DEPARTMENT OF  
**ECOLOGY**  
State of Washington

## Example Planting Scheme for Bioretention Swale in Spokane

Revised June 2013

Please see <http://www.ecy.wa.gov/copyright.html> for copyright notice including permissions, limitation of liability, and disclaimer.

2019 Stormwater Management Manual for Eastern Washington

Chapter 5 - Page 518

**Table 5.56: Recommended Trees for Bioretention BMPs**

Species	Common Name	Notes	Climate Region	Bioretention Zone
<i>Acer glabrum</i>	Rocky Mountain maple	Multitrunked. Best in moist, partly sunny areas	1, 4	2
<i>Acer rubrum</i>	Red maple	Grows tall and spindly in stands. Dense shrub alone. Reddish-orange fall color.	1, 3, 4	1, 2
<i>Alnus incana</i>	Mountain alder	Small- to medium-size tree with smooth grey bark, even in old age.	3, 4	1, 2
<i>Betula nigra</i>	River birch	Peeling bark lends winter interest. Unaffected by birch borers.	1, 2, 3, 4	1, 2
<i>Betula occidentalis</i>	Water birch	Spring catkins. Yellow fall color.	1, 3	1, 2
<i>Celtis occidentalis</i>	Common hackberry	Can tolerate a variety of soil conditions.	1, 2, 3, 4	2
<i>Celtis laevigata</i>	Netleaf hackberry trees	Native to eastern Washington. Prefers moist soils.	1, 2, 3, 4	2
<i>Crataegus douglasii</i>	Douglas hawthorn	Clusters of white flowers in spring followed by large edible scarlet berries that turn black and persist into winter.	1, 2, 3, 4	2
<i>Frangula purshiana</i>	Cascara	Attractive in all seasons. Leaves are bright green in spring, turning dark and glossy in the summer.	1, 4	1, 2
<i>Ginkgo biloba</i>	Maidenhair tree	Unique leaf and beautiful fall color. Select male plants to avoid foul smelling fruit.	1, 2, 3, 4	2
<i>Gleditsia triacanthos</i> var. <i>inermis</i>	Thornless honey locust	Airy, lacy leaves appear in late spring. Yellow fall color.	1, 2, 3, 4	2
<i>Gymnocladus dioicus</i>	Kentucky coffee tree	Bold year-round texture. Late to leaf out. Fruit pods can be messy. Prefers rich soil.	1, 3, 4	2
<i>Juglans nigra</i>	Black walnut	Deep tap root	1, 3, 4	2
<i>Juniperus scopulorum</i>	Rocky Mountain juniper	Evergreen. Can tolerate a variety of soils and moisture conditions.	1, 2, 3, 4	2
<i>Larix occidentalis</i>	Western larch	Deciduous conifer. Leaves turn bright yellow in autumn and eventually fall.	1, 2, 3, 4	2
<i>Nyssa sylvatica</i>	Black tupelo	Bright reds, oranges, yellows, and greens. Interesting form.	1, 3, 4	2
<i>Pinus contorta</i>	Lodgepole	Tall evergreen pine. Can tolerate dry, sandy	1, 2, 3	2

**Table 5.56: Recommended Trees for Bioretention BMPs (continued)**

Species	Common Name	Notes	Climate Region	Bioretention Zone
	pine	conditions once established.	,4	
<i>Pinus nigra</i>	Austrian pine	Good in the city and for windbreaks.	1, 2, 3, 4	2
<i>Pinus ponderosa</i>	Ponderosa pine	Native to upland sites.	1, 2, 3, 4	2
<i>Pinus sylvestris</i>	Scotch pine	Colorful bark.	1, 2, 3, 4	2
<i>Populus tremuloides</i>	Quaking aspen	Fast grower. Bright gold fall color and attractive bark.	1, 2, 3, 4	1, 2
<i>Prunus virginiana</i>	Chokecherry	Spikes of white creamy flowers with red berries that attract wildlife. Dark green leaves turn maroon and gold in fall.	1, 2, 3, 4	2
<i>Sequoiadendron giganteum</i>	Giant sequoia	Dense, pyramidal to columnar evergreen with reddish, furrowed bark. Can grow extremely large; may be better suited to larger planting areas.	1, 3, 4	2
<i>Quercus garryana</i>	Oregon white oak	Native oak. Drought tolerant once established. Adapts to moist or dry soils.	1, 3	2
<i>Quercus macrocarpa</i>	Bur oak	Adapts to moist or dry soils.	1,2,3,4	2
<i>Quercus palustris</i>	Pin oak	Rusty red fall color. Holds leaves in winter.	1,2,3,4	2
<i>Tilia tomentosa</i>	Silver linden	Fragrant yellow flowers clusters around fruit.	1,2,3,4	2



**Table 5.57: Recommended Shrubs for Bioretention BMPs**

Species	Common Name	Notes	Climate Region	Bioretention Zone
<i>Amelanchier alnifolia</i>	Western serviceberry	Very hardy. Drought tolerant. Needs some supplemental watering during dry months. White flowers in early spring.	1, 3, 4	2
<i>Artemesia</i> sp.	Sagebrush	Sprawling woody shrub with finely divided silver leaves. Some drought-tolerant varieties include <i>A. frigida</i> , <i>A. tripartita</i> , and <i>A. ludoviciana</i> .	1, 2, 3	2
<i>Atriplex canescens</i>	Four-wing saltbush	Extremely tolerant of all conditions.	2, 3	2
<i>Betula glandulosa</i>	Bog birch	Moist soils only. Not drought tolerant.	1, 3, 4	1
<i>Caragana arborescens</i>	Siberian pea shrub	Pealike bloom and seedpods that resemble string beans.	2, 3	2
<i>Caragana frutex</i>	Russian pea shrub	More erect than Siberian pea shrub.	1, 2, 3	1, 2
<i>Caryopteris x clandonensis</i>	Blue mist spiraea	Blue blooms in late summer. May be used as a perennial.	1, 3, 4	2
<i>Cercocarpus ledifolius</i>	Curl leaf mountain mahogany	Multistemmed large shrub or small tree. Evergreen.	2, 3, 4	2
<i>Chamaebatiaria millefolium</i>	Fernbush, desert sweet	Fragrant. Fern-like leaves. Showy flowers attract bees. Drought tolerant.	2, 3, 4	2
<i>Cornus alba</i>	Tatarian dogwood	Variegated leaf. Red twig lends winter interest. Deer resistant.	1, 2, 3, 4	2
<i>Cornus sericea</i>	Redosier dogwood	Red twig lends winter interest. Deer resistant.	1, 2, 3, 4	2
<i>Cornus sericea</i> 'Flaviramea'	Yellowtwig dogwood	Yellow twig lends winter interest. Some variegated cultivars. Deer resistant.	1, 2, 3, 4	2
<i>Cotinus coggygria</i>	Smoke tree	Multistemmed shrub. Soft, cloudlike masses of pinkish clusters. 'Royal Purple' cultivar with brownish-purple foliage is also a nice option.	1, 2, 3, 4	2
<i>Dasiphora fruticosa</i>	Shrubby cinquefoil	Yellow blooms in summer. Newer varieties in other colors. Flowers best in full sun.	1, 2, 3, 4	1, 2
<i>Ericameria nauseosa</i>	Rabbitbrush	Bright yellow blooms in fall. Upright foliage. Thin narrow grey leaves make attractive foliage. Green rabbitbrush is also an option. Recommend 'Tall Blue' cultivar.	2, 3	2

**Table 5.57: Recommended Shrubs for Bioretention BMPs (continued)**

Species	Common Name	Notes	Climate Region	Bioretention Zone
<i>Fallugia paradoxa</i>	Apache plume	Pink, silky plumed seed heads cover plant for many months.	2	2
<i>Forestiera neomexicana</i>	New Mexico privet	Only females produce black berries. Beautiful bark. Yellow fall color. Substitute for aspen and birch.	2	2
<i>Helianthemum</i> cultivars	Sunrose	Clumping evergreen, low spreading shrub with brightly colored flowers. Tolerates poor soils.	1, 2, 3, 4	2
<i>Holodiscus discolor</i>	Ocean spray	White flower, red or burgundy fall color. Dwarf cultivars available.	2	2
<i>Krascheninnikovia lanata</i>	Winterfat	Good for erosion control.	2, 3, 4	2
<i>Mahonia aquifolium</i>	Tall Oregon grape	Prefers partial shade in hot, dry areas.	1, 2, 3, 4	2
<i>Mahonia nervosa</i>	Dull Oregon grape	Prefers partial shade in hot, dry areas.	1, 2, 3, 4	1,2
<i>Mahonia repens</i>	Creeping Oregon grape	Green leathery leaves turn reddish in fall. Yellow flowers followed by tasty purple berries.	1, 2, 3, 4	1, 2
<i>Paxistima myrsinites</i>	Oregon boxleaf	Found in higher elevations in relatively dry, open, sunny sites or open forests. Prefers partial shade in hot, dry area.	1, 2, 3, 4	2
<i>Penstemon fruticosus</i>	Shrubby penstemon	Showy, drought-tolerant, and low-growing native.	1, 3, 4	2
<i>Philadelphus lewisii</i>	Mock orange	Beautiful, fragrant white blooms in late spring.	1, 2, 3, 4	2
<i>Physocarpus malvaceus</i>	Mallow ninebark	Exfoliating bark. Attractive seed pods.	1, 2, 3, 4	1
<i>Pinus mugo</i> var. <i>mugo</i>	Mugo pine	Protect from drying summer winds.	1, 2, 3, 4	2
<i>Prunus</i> sp.	Shrub cherry	Several cultivars available.	1, 2, 3, 4	2
<i>Purshia tridentata</i>	Bitterbrush	Small yellow blooms with small, fresh-scented silvery leaves.	1, 2, 3, 4	2
<i>Rhus glabra</i>	Smooth sumac	Striking red fall color.	1, 2, 3, 4	2
<i>Rhus trilobata</i>	Oakleaf Sumac	Does well in wet and dry conditions.	1, 2, 3, 4	1,2

**Table 5.57: Recommended Shrubs for Bioretention BMPs (continued)**

Species	Common Name	Notes	Climate Region	Bioretention Zone
		Striking fall color. Forms dense thickets by spread of rhizomes or underground root structures.		
<i>Ribes aureum</i>	Golden currant	Scented yellow flowers from April to May. Flowers attract hummingbirds.	1, 2, 3, 4	1,2
<i>Ribes cereum</i>	Wax currant	Small white blossoms followed by bright red berries. Attracts several bird species.	1, 2, 3, 4	2
<i>Ribes lacustre</i>	Swamp currant	Appropriate for BMPs near riparian and wetland areas.	1, 2, 3, 4	1, 2
<i>Ribes sanguineum</i>	Red flowering currant	Early leaf-out. Fragrant pinkish-red flower. Edible fruit. Drought tolerant.	1, 2, 3, 4	2
<i>Ribes viscosissimum</i>	Sticky current	Appropriate for BMPs near riparian and wetland areas.	1, 2, 3, 4	1, 2
<i>Rosa gymnocarpa</i>	Bald hip rose	Native shrub that grows well in part shade to shade. Plant spreads by underground rhizomes.	1, 2, 3, 4	2
<i>Rosa nutkana</i> var. <i>hispida</i>	Nootka rose	Fragrant, long-lasting blooms. Bright red hips.	1, 2, 3, 4	2
<i>Rosa woodsii</i>	Woods' rose	Clusters of aromatic pink flowers and bright red fruits.	1, 2, 3, 4	2
<i>Rubus parviflorus</i>	Thimbleberry	Showy flowers. Forms thickets. Good for wildlife; native.	1, 3, 4	2
<i>Rubus ursinus</i>	Pacific blackberry	Vining plant native to Walla Walla region. Good ground cover near natural areas.	1, 2, 3, 4	2
<i>Salix exigua</i>	Coyote willow	Native plant used for erosion control and bank stabilization in streams and wetlands. Spreads rapidly. Use near natural areas.	1, 2, 3, 4	1
<i>Salix scouleriana</i>	Scoulers willow	Tall shrub to small tree, this native species is good in full sun to part shade. Large species excellent near natural areas. Forms thickets. Not for dry conditions.	1, 2, 3, 4	1
<i>Salvia dorrii</i>	Purple sage	Native species. Purple flowers attract butterflies. Very drought tolerant once established.	1, 2, 3, 4	2
<i>Sambucus cerulea</i>	Blue elderberry	Tall shrub with masses of small berries in August and September.	1, 2, 3, 4	2

**Table 5.57: Recommended Shrubs for Bioretention BMPs (continued)**

Species	Common Name	Notes	Climate Region	Bioretention Zone
<i>Sambucus racemosa</i>	Red elderberry	Large multistem deciduous shrub. Sun to shade. Prefers moist soils, but somewhat drought tolerant.	1, 2, 3, 4	1, 2
<i>Sorbus scopulina</i>	Western mountain ash	Native shrub with large showy clusters of white flowers in later spring and summer and yellow foliage with red berries in winter. Good for pollinators and wildlife. Sun to shade. Excellent near natural areas.	1, 3, 4	2
<i>Spiraea betulifolia</i>	Birch-leaf spiraea	Small, erect shrub with many fluffy white flowers in flat-topped clusters. Less than 2 feet tall. Blooms appear June to August.	1, 4	2
<i>Spiraea douglasii</i>	Western spiraea	Fragrant pink summer flower.	1, 2, 3, 4	1
<i>Symphoricarpos albus</i>	Snowberry	White flower, white berry that attracts birds, winter interest.	1, 3, 4	2
<i>Symphoricarpos x chenaultii</i>	Chenault coralberry	Pink blooms in spring. Likes moist to dry soils. Attractive fruit.	1, 2, 3, 4	2
<i>Syringa vulgaris</i>	Common lilac	Clustered blooms. White, pink, purple, and blue blooming cultivars available. Deep green foliage.	1, 2, 3, 4	2
<i>Taxus cuspidata</i>	Japanese yew	Evergreen. Can be heavily pruned.	1, 3, 4	2
<i>Viburnum burkwoodii</i>	Burkwood viburnum	Attractive to wildlife. Nearly pest free.	1, 2, 3, 4	2
<i>Vaccinium membranaceum</i>	Mountain huckleberry	Native species excellent for wildlife habitat. Prefers moist shady conditions. Good plant for sites near natural areas.	1, 4	1, 2
<i>Yucca filamentosa</i>	Adam's needle	Cluster of green, spike-tipped leaves has a tall, showy cluster of white flowers in the summer. Hardy, drought tolerant, tough, and beautiful.	2, 3	2

**Table 5.58: Recommended Grasses for Bioretention BMPs**

Species	Common Name	Notes	Climate Region	Bioretention Zone
<i>Calamagrostis x acutiflora</i>	Feather reed grass	Natives and cultivars, upright habit, attractive flower, fall and winter interest, deer resistant. Suggest 'Karl Foerster' or 'Overdam.' Grows 4 to 6 feet high.	1, 2, 3, 4	2
<i>Carex flacca</i>	Blue sedge	Drought-tolerant evergreen sedge. Variable color. Spreads rhizomatously. Grows 12 to 16 inches high.	1, 2, 3, 4	1, 2
<i>Carex pennsylvanica</i>	Pennsylvania sedge	Full sun to part shade. Height of 8 to 10 inches. Drought tolerant after establishment.	1, 2, 3, 4	1, 2
<i>Deschampsia caespitosa</i>	Tufted hair grass	Attractive native grass with open flowers. Grows up to 3 feet high.	1, 2, 3, 4	2
<i>Festuca ovina glauca</i>	Blue fescue	Tufted mound of bluish-green grass to 10 inches. Keeps color throughout winter. Full to part sun.	1, 2, 3, 4	2
<i>Helictotrichon sempervirens</i>	Blue oat grass	Drought tolerant once established. Full sun.	1, 2, 3, 4	2
<i>Juncus effusus</i>	Common rush	Native species typical of alternately dry and wet sites. Height up to 4 feet. Can spread aggressively.	1, 3, 4	1, 2
<i>Leymus cinereus</i>	Basin wildrye	Robust plant that prefers moist sites like ditches or swales. Will form large clumps. Plant at a depth of 0.5 inches. Grows 3 to 6 feet high.	1, 2, 3, 4	1, 2
<i>Panicum virgatum</i>	Switchgrass	Attractive lacy flower, fall color, winter interest, salt-tolerant. Many varieties. Grows 3 to 5 feet high.	1, 2, 3, 4	1, 2
<i>Pennisetum sp.</i>	Fountain grass	Select for drought-tolerance. 'Hameln' is a drought-tolerant, dwarf variety.	1, 2, 3, 4	2
<i>Pseudoroegneria spicata</i>	Bluebunch wheatgrass	Large bunchgrass grows 1.5 to 4 feet tall. Slow to establish, but very hardy once established. Plant at a depth of 0.25 inches. Sun. Intolerant to flooding.	1, 2, 3, 4	2
<i>Schizachyrium scoparium</i>	Little bluestem	Reddish tones in fall. Suggest 'The Blues.' Sun. Best on side slopes and top of slopes due to moderate tolerance to flooding.	1, 2, 3, 4	1, 2

**Table 5.59: Recommended Perennials and Wildflowers for Bioretention BMPs**

Species	Common Name	Notes	Climate Region	Bioretention Zone
<i>Achillea millefolium</i>	Common yarrow	A perennial herb that produces one to several stems.	1, 2, 3, 4	2
<i>Achillea tomentosa</i>	Wooly yarrow	Fire-resistant, fern-like leaves, flat clusters of yellow flowers in spring.	1, 2, 3, 4	2
<i>Aethionema schistosum</i>	Fragrant Persian rock cress	Evergreen foliage. Powder-blue bloom. Reseeds.	1, 2, 3, 4	2
<i>Agastache</i> sp.	Hyssop	Purple blooms. Sage-like appearance. Attracts butterflies. <i>A. canna</i> is hardy to Zone 3. Also suggest <i>A. rupestris</i> .	1, 3	2
<i>Alchemilla mollis</i>	Lady's mantle	Needs more water in full sun. Prefers moist to somewhat dry soil.	1, 2, 3, 4	1, 2
<i>Alyssum saxatile compactum</i>	Goldkugel Basket of gold	Compact. Attractive silver-gray foliage.	1, 2, 3, 4	2
<i>Amsonia</i> sp.	Blue star flower	Star-shaped blossoms.	1, 3	2
<i>Anaphalis margaritacea</i>	Pearly everlasting	Tiny, white flowers crowded in small, flat, fluffy heads.	1, 2, 3, 4	2
<i>Anemone</i> sp.	Anemone wildflower	White, pink, or rose flowers, depending on variety.	1, 2, 3, 4	2
<i>Anthemis</i> sp.	Marguerite daisy	<i>A. biebersteinana</i> features feathery silver foliage and blooms in late spring. <i>A. tinctoria</i> is a taller, shrubbier species with a golden-yellow, daisy-like bloom.	1, 2, 3, 4	2
<i>Armeria maritima</i> 'Compacta'	Compact sea pink	Tidy, grass-like foliage with flowers held on stems above.	1, 2, 3, 4	2
<i>Artemisia</i> sp.	Sage, Silvermound	Used for silvery, lacy foliage. Drought-tolerant species include <i>A.</i> 'Powis Castle,' <i>A. abortanum</i> , and <i>A. stelleriana</i> .	1, 2, 3, 4	2
<i>Asclepias speciosa</i>	Showy milkweed	Native. The abundant nectar of milkweed flowers attracts hummingbirds, butterflies, honey bees, native bees, and other beneficial insects. Spread by rhizomes and seeds.	1, 2, 3, 4	1, 2
<i>Asclepias tuberosa</i>	Milkweed Butterfly weed	Orange blooms. Attracts butterflies.	1, 2, 3, 4	2

**Table 5.59: Recommended Perennials and Wildflowers for Bioretention BMPs (continued)**

Species	Common Name	Notes	Climate Region	Bioretention Zone
<i>Aster</i> sp.	Aster	Many varieties, later summer bloom, deer resistant, <i>Symphotrichum spathulatum</i> is a native species. <i>A. tataricus</i> known to be drought-tolerant.	1, 2, 3, 4	2
<i>Aquilegia coerulea</i>	Blue columbine	Attractive to bees, butterflies, and birds.	1, 2, 3, 4	2
<i>Aquilegia formosa</i>	Western columbine	Native hummingbird species with showy orange and yellow flowers in spring. Drought tolerant after establishment. Prefers full to part shade but will tolerate full sun in moist soils.	1, 2, 3, 4	1, 2
<i>Arnica cordifolia</i>	Heart-leaf leopard bane	Drought tolerant native plant found in sun to shade.	1, 3, 4	1, 2
<i>Balsamorhiza sagittata</i>	Arrow-leaf Balsamroot	Sunflower-like bloom. Trident-shaped silver blue leaves.	1, 2, 3, 4	2
<i>Baptisia australis</i>	Blue false indigo	Blue blooms in late spring.	1, 2, 3, 4	2
<i>Callirhoe involucrata</i>	Poppy mallow	Reddish-purple bloom. Long-lived.	1, 2, 3, 4	2
<i>Calylophus serrulatus</i>	Dwarf sundrops	Heavy bloomer.	1, 2, 3, 4	2
<i>Camassia leichtlinii</i>	Large camas	Native to western Washington, this lily has showy blue, purple, pink, or lavender flowers. Plants need moist soil and are not drought tolerant.	3, 4	1
<i>Camassia quamash</i>	Blue camas	Blooms early summer.	3, 4	1, 2
<i>Castilleja</i> sp.	Indian paintbrush	Excellent pollinator species.	1, 2, 3, 4	1, 2
<i>Coreopsis grandiflora</i>	Coreopsis	Low grower. Yellow flowers from mid- to late summer. Prefers well-drained soils. Drought-tolerant.	1, 2, 3, 4	2
<i>Dianthus</i> sp.	Pink	Pink, red, or white blooms. Dainty appearance. Select for hardiness.	1, 2, 3, 4	2
<i>Dryas octopetala</i>	White dryas	Small white flowers on short stalks with wispy seed heads. Alpine. Forms a low carpet. Spreads slowly.	1, 2, 3, 4	2

**Table 5.59: Recommended Perennials and Wildflowers for Bioretention BMPs (continued)**

Species	Common Name	Notes	Climate Region	Bioretention Zone
<i>Echinacea purpurea</i>	Purple coneflower	Purple flowers in May through August. Excellent for attracting butterflies. Drought tolerant.	1, 2, 3, 4	2
<i>Echinops ritro</i>	Globe thistle	Blooms appear in June and can last until fall. Tolerant of a variety of light conditions and soil types. Suggest 'Taplow Blue.'	1, 2, 3, 4	2
<i>Erigeron speciosus</i>	Showy fleabane	Yellow flowers for many weeks in late spring to early summer. Blooms in May and June.	1,2,3,4	2
<i>Eriogonum umbellatum</i>	Sulphur-flower buckwheat	Needs pruning to keep compact. Very drought tolerant.	1, 3, 4	2
<i>Eryngium</i> sp.	Sea holly	Select for hardiness and perennial growth. Suggest 'Sapphire Blue.'	1, 2, 3, 4	2
<i>Eschscholzia californica</i>	California poppy	Bluish green fern-like leaves with orange flowers. Flowers open during day and close at night. Spicy fragrance.	1, 2, 3, 4	2
<i>Filipendula vulgaris</i>	Dropwort	Basal growing fern-like leaves.	1, 2, 3, 4	1, 2
<i>Gaillardia aristata</i>	Blanket flower	Hardy brilliant red flowers with yellow rims.	1, 2, 3, 4	2
<i>Geranium</i> sp.	Cranesbill	Many species/varieties. Finely lobed foliage. Select for drought-tolerance. <i>G. sanguineum</i> features rose, pink, white, or purple flowers throughout summer. <i>G. macrorrhizum</i> is attractive to wildlife.	1, 2, 3, 4	2
<i>Geum macrophyllum</i>	Large leaf avens	Hairy perennial with short rhizomes and big leaves topped by small yellow flowers. Prefers part to full shade. Spreads readily by seed. Great for sites near natural areas.	1, 2, 3, 4	1
<i>Geum triflorum</i>	Prairie smoke	Large stands of the plant create a gauzy effect that resembles smoke hovering close to the ground. Full sun. Drought tolerant.	1, 2, 3, 4	2
<i>Helianthella uniflora</i>	Little sunflower	Sunflower-like bloom. Single flower stalk.	1, 2, 3, 4	2
<i>Hemerocallis</i> 'Stella d'Oro'	Stella d'Oro daylily	Long bloom in spring and summer. Tough plant. Yellow blooms. Smaller than other daylilies.	1, 2, 3, 4	2
<i>Heuchera</i>	Roundleaf	Plant in full sun to partial shade and in well-	1, 2, 3,	1, 2



**Table 5.59: Recommended Perennials and Wildflowers for Bioretention BMPs (continued)**

Species	Common Name	Notes	Climate Region	Bioretention Zone
<i>cylindrica</i>	alumroot	drained moist to dry soil. Drought tolerant.	4	
<i>Hosta</i> sp.	Hosta	Variegated foliage.	1, 2, 3, 4	2
<i>Hypericum calycinum</i>	St. John's wort	Yellow blooms in summer.	1, 3, 4	2
<i>Ipomopsis aggregata</i>	Scarlet gilia	Bright red flowers on long stem and higher germination success and seedling survival in disturbed soils. Drought tolerant and shade tolerant.	1, 2, 3, 4	2
<i>Iris sibirica</i>	Siberian iris	Blue flower in spring, attractive leaf, deer resistant.	1, 2, 3, 4	2
<i>Lavandula</i> sp.	Lavender	Showy, fragrant purple flowers. Several varieties. Requires pruning once per year for first 3 years of establishment. Drought tolerant after establishment.	1, 2, 3, 4	1, 2
<i>Lewisia rediviva</i>	Bitterroot	Various blooms. Good for rock gardens.	1, 2, 3, 4	2
<i>Liatris punctata</i>	Gayfeather	Sends up dense flower stalks. Blooms in the later summer. Prefers well-drained soils. More drought-tolerant than <i>L. spicata</i> . Also consider <i>L. aspera</i> .	1, 2, 3, 4	2
<i>Limonium latifolium</i>	Sea lavender	Looks like a delicate cloud of lavender, pink, or white flowers.	1, 2, 3, 4	1, 2
<i>Linum lewisii</i>	Wild blue-flax	Native. Blue blooms in summer. Reseeds if not cut back. There is a nonnative blue flax that is very aggressive. Take precautions to plant the native.	1, 2, 3, 4	2
<i>Lupinus</i> sp.	Lupine	Many species and varieties. Select for drought-tolerance. <i>L. sericeus</i> is a native, purple-flowered lupine of dry areas with short-lived blooms.	1, 2, 3, 4	2
<i>Matteuccia struthiopteris</i>	Ostrich fern	Striking size and form. Feathery fronds.	1, 2, 3, 4	1,2
<i>Nepeta</i> sp.	Catmint	Dainty purple blooms throughout the summer. Prefers well-drained soils. Drought-tolerant.	1, 2, 3, 4	2
<i>Oenothera caespitosa</i>	Evening primrose	<i>O. missouriensis</i> has a yellow flower; native to the Midwest.	1, 2, 3, 4	2

**Table 5.59: Recommended Perennials and Wildflowers for Bioretention BMPs (continued)**

Species	Common Name	Notes	Climate Region	Bioretention Zone
<i>Opuntia</i> sp.	Prickly pear	Various blooms. Desert plant. Suggest <i>O. humifusa</i> .	2, 3	2
<i>Origanum vulgare</i>	Oregano	Do not overwater. Edible.	1, 2, 3, 4	2
<i>Penstemon x gloxinoides</i>	Garden penstemon	Blooms in spring in dry rocky sites.	1, 2, 3, 4	2
<i>Perovskia atriplicifolia</i>	Russian sage	Silvery foliage. Lavender spikes.	1, 2, 3, 4	2
<i>Polystichum munitum</i>	Sword fern	Drought tolerant once established.	1, 4	2
<i>Ratibida columnifera</i>	Prairie coneflower	Red and yellow, columnar flower heads up to 3 inches.	1, 2, 3, 4	2
<i>Rudbeckia fulgida</i> 'Goldsturm'	Black-eyed Susan	Bright yellow blooms with dark centers midsummer through early fall.	1, 2, 3, 4	2
<i>Salvia</i> sp.	Sage (gray ball)	Small gray-green shrub. Intolerant of shade.	1, 2, 3, 4	2
<i>Salvia pachyphylla</i>	Giant flowered purple sage	Giant flowered purple sage blooms all summer and is evergreen.	1, 2, 3, 4	2
<i>Salvia x sylvestris</i>	Purple sage	'Mainacht' is drought-tolerant.	1, 2, 3, 4	2
<i>Solidago</i> sp.	Goldenrod	Bright yellow blooms on stalks. May lie horizontal or upright. <i>S. canadensis</i> and <i>S. occidentalis</i> are native. Some varieties of <i>S. rugosa</i> are drought-tolerant.	1, 2, 3, 4	2
<i>Sphaeralcea</i> sp.	Globe-mallow	Select for drought-tolerance. Suggest currant-leaved globemallow ( <i>S. grossularifolia</i> ) and orange globemallow ( <i>S. incana</i> ).	1, 2, 3, 4	2
<i>Stanleya pinnata</i>	Prince's plume	Spectacular spires of yellow flowers. Takes 1 to 2 years to become well established. Very susceptible to herbicides.	1, 2, 3, 4	2
<i>Xerophyllum tenax</i>	Bear grass	Bear grass is a fire-resistant species that does best in xeric to fairly dry conditions. It grows well in sun and part shade and is often associated with evergreen trees.	1, 2, 3, 4	2

**Table 5.60: Recommended Ground Covers for Bioretention BMPs**

Species	Common Name	Notes	Climate Region	Bioretention Zone
<i>Arctostaphylos uva-ursi</i>	Kinnickinnick	Ground-hugging evergreen plant with glossy green leaves change to red color in fall. Small, bell-shaped pink flowers in spring, followed by small, 0.5-inch red berries.	1, 2, 3, 4	2
<i>Antennaria rosea</i>	Pink pussytoes	Spreads and self-sows rapidly.	1, 2, 3, 4	2
<i>Arabis caucasica</i>	Wall cress	White or pink blooms emerge in spring.	1, 2, 3, 4	1, 2
<i>Asarum caudatum</i>	Wild ginger	Partial to full shade. Drought tolerant after establishment. Good species under evergreen tree canopy.	1, 4	2
<i>Campsis radicans</i>	Trumpet creeper	Vigorous vine often used for green walls and other vertical structures or as a ground cover. Needs some support. Plant with care; can become aggressive. Deciduous to partly evergreen.	1, 2, 3, 4	2
<i>Ceanothus prostratus</i>	Squaw carpet	Evergreen. Showy blue/purple flowers.	1, 4	1, 2
<i>Clematis columbiana</i>	Blue rock clematis	Native ground cover or climbing vine with pale purple flowers.	1, 2, 3, 4	2
<i>Clematis ligusticifolia</i>	Western white clematis	Excellent native clematis ground cover that is good for erosion control. Drought tolerant. Be careful to not mix this species up with the invasive clematis species.	1, 2, 3, 4	2
<i>Cornus canadensis</i>	Bunchberry	Native to northern areas of state. Requires full shade. Associated with conifer species.	1, 4	2
<i>Eriogonum</i> sp.	Buckwheat	Evergreen, ground covering shrub is native to the western United States. Large clusters of creamy white flowers grace low shrubs with narrow, frosty-green leaves. Drought-tolerant varieties include <i>E. heracleoides</i> , <i>E. niveum</i> , and <i>E. umbellatum</i> .	1, 3	1, 2
<i>Fragaria virginiana</i>	Wild strawberry	White or pink flower, edible berries, spreads by surface runners, deer resistant.	1, 3, 4	2
<i>Helianthemum nummularium</i>	Sunrose	Evergreen. Gray or green leaves, very colorful flowers in midsummer. Shear after first flower to encourage fall bloom.	1, 2, 3, 4	2
<i>Juniperus horizontalis</i>	Creeping juniper	Ground-hugging evergreen plant with glossy green leaves change to red color in fall.	1, 2, 3, 4	2

**Table 5.60: Recommended Ground Covers for Bioretention BMPs  
(continued)**

Species	Common Name	Notes	Climate Region	Bioretention Zone
		Small, bell-shaped pink flowers in spring, followed by small, 0.5-inch red berries.		
<i>Linnaea borealis</i>	Twinflower	Creeping evergreen vine. Grows best in moist, shady woods and forests.	1, 4	2
<i>Lonicera ciliosa</i>	Orange honeysuckle	Bright orange flower clusters. Drought tolerant after established, but prefers moist soils. Full sun, but best in part shade. Deer resistant.	1, 3, 4	2
<i>Microbiota decussata</i>	Russian cypress	Foliage turns bronze in winter if in full sun.	1, 2, 3, 4	2
<i>Persicaria affinis</i>	Himalayan fleecflower	Pink blooms in late summer.	1, 2, 3, 4	1, 2
<i>Phlox</i> sp.	Phlox	Many species and varieties, some native. Select for drought-tolerance. <i>P. subulata</i> is readily available.	1, 2, 3, 4	2
<i>Potentilla</i> sp.	Cinquefoil	Delicate, bright green leaves with bright yellow flowers in spring and summer. Fast growing.	1, 2, 3, 4	2
<i>Sedum</i> sp.	Stonecrop	Mat-forming evergreen plant. Tolerates some shade, requires good drainage. 'Cape Blanco' and 'Purpureum' are drought-tolerant.	1, 2, 3, 4	2
<i>Sempervivum</i> sp.	Hen and chicks	Does best in gravelly soil.	1, 2, 3, 4	2
<i>Teucrium</i> sp.	Germander	Evergreen. Woody upright stems with dark green, toothy leaves.	1, 2, 3, 4	2
<i>Thymus</i> sp.	Thyme	Mat forming, spreading plants. Silver gray foliage. <i>T. lanuginosus</i> and <i>T. pseudolanuginosus</i> are low evergreen species. <i>T. praecox</i> is deciduous and grows to 6 inches.	1, 2, 3, 4	2
<i>Veronica</i> sp.	Speedwell	Suggest <i>V. oltensis</i> and <i>V. pectinata</i> .	1, 2, 3, 4	2
<i>Zinnia grandiflora</i>	Rocky Mountain zinnia	Deer resistant.	1, 2, 3, 4	1, 2

## 5.B.4 Stormwater Treatment Wetlands Plant List

**Table 5.61: Emergent Wetland Plant Species Recommended for Stormwater Treatment Wetlands in Arid and Cold Climates in Eastern Washington**

Species	Common Name	Notes	Saturation Tolerance
<b>Moist to Saturated Soils</b>			
<i>Agrostis idahoensis</i>	Idaho bent grass	Prairie, wet meadows	Does not withstand flooding or moist soil
<i>Calamagrostis canadensis</i>	Bluejoint reedgrass	Meadows and open understory, along streams and pond margins	High tolerance to anaerobic conditions
<i>Carex praegracilis</i>	Clustered field sedge	Moist meadows, along ponds and streams	High tolerance to anaerobic conditions
<i>Deschampsia caespitosa</i>	Tufted hairgrass	Prairie to coast	Moist to dry soils
<i>Distichlis spicata</i>	Saltgrass	Useful in saline/alkaline soils	High tolerance to anaerobic conditions
<i>Juncus confusus</i>	Colorado rush	Moist meadows, along streams	High tolerance to anaerobic conditions
<i>Poa palustris</i>	Fowl bluegrass	Meadows	Medium tolerance to anaerobic conditions
<i>Puccinellia nuttalliana</i>	Nuttall's alkaligrass	Moist alkaline soils	High tolerance to anaerobic conditions
<i>Spartina pectinata</i>	Prairie chordgrass	Floodplains, wet meadows, seasonally dry sites, tolerates alkaline conditions and high ground water table	Does not withstand prolonged inundation
<b>Inundation to 1 Foot</b>			
<i>Beckmania syzigachne</i> <sup>a</sup>	American sloughgrass	Wet meadows to pond margins	High tolerance to anaerobic conditions
<i>Carex nebrascensis</i>	Nebraska sedge	Wet meadows to pond margins	Can tolerate standing water about 3 months, as long as there are periods when the soil is dry.
<i>Carex utriculata</i>	Northwest territory sedge	Wet soil to standing water	High tolerance to anaerobic conditions
<i>Glyceria occidentalis</i>	Western mannagrass	Marshes, pond margins	Best adapted to semiaquatic habitat, flooded or saturated for up to 25% of the growing

**Table 5.61: Emergent Wetland Plant Species Recommended for Stormwater Treatment Wetlands in Arid and Cold Climates in Eastern Washington (continued)**

Species	Common Name	Notes	Saturation Tolerance
			season
<i>Juncus articulatus</i>	Jointed rush	Wet soils, wetland margins	High tolerance to anaerobic conditions
<i>Juncus ensifolius</i>	Dagger-leaf rush	Wet meadows, pastures, wetland margins	High tolerance to anaerobic conditions
<i>Juncus torreyi</i>	Torrey's rush	Moist to wet meadows, margins of streams, often where saline or alkaline	Medium anaerobic tolerance
<b>Inundation 1 to 3 Feet</b>			
<i>Eleocharis palustris</i>	Common spike rush	Margins of ponds, wet meadows	Inundation up to 3 feet; can survive where water table drops to 1 foot below surface
<i>Schoenoplectus acutus</i> <sup>b</sup>	Hardstem bulrush	Single tall stems, not clumping	3 feet
<i>Schoenoplectus tabernaemontani</i> <sup>b</sup>	Softstem bulrush	Wet ground to shallow water	Deep or shallow water
<i>Scirpus microcarpus</i> <sup>b</sup>	Small-fruited bulrush	Wet ground to 18 inches depth	Does best in < 18 inches of water
<b>Inundation Greater Than 3 Feet</b>			
<i>Nuphar polysepalum</i>	Yellow water-lily	Deep water; aquatic species	3 to 7.5 feet
<i>Potamogeton natans</i>	Floating-leaf pondweed	Shallow to deep ponds; aquatic species	6 feet
<p>Primary sources: (<a href="#">Ecology, 1993b</a>), (<a href="#">Hortus Northwest, 1993</a>), (<a href="#">Hitchcock and Cronquist, 1973</a>).</p> <p><sup>a</sup>Nonnative species. However <i>Beckmania syzigachne</i> is native to Oregon.</p> <p><sup>b</sup><i>Scirpus</i> tubers must be protected from foraging waterfowl (e.g., using methods such as biodegradable stakes, coyote decoys, canine patrols, etc.) until established. Emerging aerial stems should project above water surface to allow oxygen transport to the roots.</p>			

# Chapter 6 - Flow Control BMP Design

## 6.1 Introduction

This chapter of the *Stormwater Management Manual for Eastern Washington* (manual) focuses on techniques and Best Management Practices (BMPs) related to implementation of [2.7.7 Core Element #6: Flow Control](#). This chapter presents methods, criteria, and details for hydraulic analysis and design of flow control BMPs. Flow control BMPs are detention, infiltration, or evaporation BMPs engineered to meet the flow control standards specified by the regulatory agency.

The design criteria outlined in this chapter apply only to those infiltration BMPs used for flow control. Design criteria for infiltration BMPs used for runoff treatment are listed in [Chapter 5 - Runoff Treatment BMP Design](#).

Design considerations for conveyance systems are not included in the manual, as this topic is adequately covered in standard engineering references.

In the general design of flow control BMPs, the optimal placement of multiple small-scale retention/infiltration BMPs within a contributing area may require less total storage capacity to meet a given peak flow rate target than a single large BMP at the drainage outlet. Application of low impact development (LID) techniques may also result in decreased storage requirements; see the discussion of LID site planning in [3.D.2 LID Site Planning](#).

## 6.2 Detention BMPs

### 6.2.1 Purpose

Detention BMPs provide for the temporary storage of increased stormwater runoff resulting from development pursuant to the performance standards set forth by the regulatory agency.

This section presents the methods, criteria, and details for design and analysis of the following types of detention BMPs:

- [BMP F6.10: Detention Ponds](#)
- [BMP F6.11: Detention Tanks](#)
- [BMP F6.12: Detention Vaults](#)
- [BMP F6.13: Rainwater Harvesting](#)

### 6.2.2 Application

Detention BMPs can be used to meet [2.7.7 Core Element #6: Flow Control](#). For project sites at which infiltration or dispersion is feasible, infiltration BMPs ([6.3 Infiltration BMPs](#)) or dispersion BMPs ([6.5 Dispersion BMPs](#)) may be preferred over the detention BMPs described in this section because they better mimic predisturbance hydrologic conditions and are often smaller and easier to maintain.

[Table 6.1: Applicability of Detention BMPs for Runoff Treatment, Flow Control, and Conveyance](#) summarizes the applicability of detention BMPs for runoff treatment, flow control, and conveyance.

**Table 6.1: Applicability of Detention BMPs for Runoff Treatment, Flow Control, and Conveyance**

BMP	Runoff Treatment					Flow Control	Conveyance
	Pretreatment	Basic	Metals	Oil Control	Phosphorus		
<a href="#">BMP F6.10: Detention Ponds</a>						✓	
<a href="#">BMP F6.11: Detention Tanks</a>						✓	
<a href="#">BMP F6.12: Detention Vaults</a>						✓	
<a href="#">BMP F6.13: Rainwater Harvesting</a>						✓	

Rainwater harvesting systems are typically used where rainfall or other environmental conditions limit the availability of domestic water supply, but can provide multiple environmental and economic benefits. Applications and limitations on the use of rainwater harvesting systems include the following:

- Arid and semiarid climates where water availability is scarce
- Residential and commercial sites with high demands for irrigation and/or nonpotable water
- Indoor reuse of harvested water for toilet flushing and cold water for laundry
- Exterior reuse of harvested water for cleaning, irrigation, and other nonpotable uses
- Combined sewer overflow (CSO) reduction in urban areas
- Appropriate only for collection of stormwater runoff from roof surfaces and not from vehicle or pedestrian areas, stormwater runoff, or bodies of standing water

Indoor reuse typically requires pumping and treatment, which may increase the long-term costs for this BMP. However, in urbanized areas where land rents are high, these systems may allow scarce land resources to be placed into use and provide valuable educational opportunities. Check with the local jurisdiction and applicable plumbing code requirements for allowable indoor and outdoor reuse applications and associated design requirements.

Urban areas with CSO problems can use rainwater harvesting systems to capture, store, reuse, and/or slowly release detained stormwater, thereby minimizing peak stormwater flow rates to the combined sewer systems and helping to reduce CSO frequency and volume.



### 6.2.3 Cold Climate Considerations

Cold climates can present additional challenges to the selection, design, and maintenance of runoff treatment BMPs due to the potential for pipe freezing, ice clogging of orifice or other control structures, short growing season (for landscaped BMPs), and need to manage snowfall. Designers of runoff treatment BMPs in cold climates should be aware of these challenges and make provisions for them in their final designs.

Regions which have an average daily maximum temperature of 35°F or less during January, and which have a growing season < 120 days, are especially vulnerable to the effects of cold weather. These cold weather conditions exist in many parts of eastern Washington and are therefore an important design concern. See [5.2.4 Cold Weather Considerations](#) for additional information on cold weather challenges to BMP design.

### 6.2.4 Arid and Semiarid Climate Considerations

For vegetated detention pond BMPs in arid/semiarid portions of eastern Washington, plants should be selected to be drought tolerant and not require watering after establishment (2 to 3 years). In more arid environments, watering may be needed during prolonged dry periods after plants are established.

Rainwater harvesting BMPs can be used in environments where rainfall or other conditions limit water supply. Many areas of eastern Washington are situated in climate zones where rainwater collection systems, in the form of cisterns, may provide beneficial use.

A challenge in eastern Washington is that the majority of the rainfall occurs during the winter and spring. Summer water demand for irrigation typically exceeds the amount of rainwater harvested on the site. Consequently, rainwater harvesting systems that are used as the sole supply for irrigation will need to be connected with a water supply so that the tanks do not go dry in the summer.

### 6.2.5 BMPs for Detention

#### BMP F6.10: Detention Ponds

The design criteria in this section are for detention ponds. However, many of the criteria also apply to infiltration ponds ([6.3 Infiltration BMPs](#) and [Chapter 5 - Runoff Treatment BMP Design](#)). Detention ponds are not subject to Underground Injection Control (UIC) regulations (see [5.6 Subsurface Infiltration \(Underground Injection Control Wells\)](#)).

#### General Criteria

Detention ponds must meet the requirements of [2.7.7 Core Element #6: Flow Control](#), particularly the release rates, and any additional requirements established by the permitting agency or local jurisdiction. To protect stream habitat, the 2-year runoff volume for the proposed development conditions must be released at a rate that does not exceed 50% of the predeveloped or existing 2-year peak flow rate. The detention pond should also match the 25-year peak flow rate for predeveloped or existing conditions; or it may match flow rate(s) for a different or additional recurrence interval(s) established by the permitting agency or local jurisdiction. For hydrologic analysis methods to determine these flow rates, see [Chapter 4 - Hydrologic Analysis and Design](#).

Standard details for detention ponds are shown in [Figure 6.1: Typical Detention Pond](#) through [Figure 6.3: Overflow Structure](#). Control structure details are provided in [6.2.6 Control Structures](#)

Ponds may be designed as flow-through systems (however, parking lot storage may be utilized through a backup system; see [6.2.7 Supplemental Guidelines for Detention](#)). Developed flows must enter through a conveyance system separate from the control structure and outflow conveyance system. Maximizing distance between the inlet and outlet is encouraged to promote sedimentation.

Pond bottoms should be level and be located a minimum of 0.5 feet (preferably 1 foot) below the inlet and outlet to provide sediment storage.

The design professional should carefully consider and evaluate any situation where a pond will be situated upslope from a structure or behind the top of a slope inclined in excess of 15%. Check local critical area ordinances for unstable slopes. The minimum setback from such a slope is greater than or equal to the height of the slope, unless the design professional can justify a lesser setback based on a comprehensive site evaluation.

### **Dam Safety for Detention BMPs**

Very large stormwater detention BMPs that can impound  $\geq 10$  acre-feet (435,600 cubic feet; 3.26 million gallons) with the water level at the embankment crest or have an embankment height of  $> 6$  feet at the downstream toe are subject to the state's dam safety requirements, even if water storage is intermittent and infrequent ([WAC 173-175-020\(1\)](#)). The principal safety concern is for the downstream population at risk if the dam should breach and allow an uncontrolled release of the pond contents. Peak flows from dam failures are typically much larger than the 100-year design flows that these ponds are typically designed to accommodate.

Dam safety considerations generally apply only to the volume of water stored above natural ground level. Per the definition of dam height in [WAC 173-175-030](#), natural ground elevation is measured from the downstream toe of the dam. If a trench is cut through natural ground to install an outlet pipe for a spillway or low-level drain, the natural ground elevation is measured from the base of the trench where the natural ground remains undisturbed.

The Washington State Department of Ecology (Ecology), Dam Safety Office is available to provide written guidance documents and technical assistance to project proponents and designers in understanding and addressing the dam safety requirements for their specific project. If the pond will meet the size or depth criteria for dam safety, it is requested that the Dam Safety Office be contacted early in the BMP planning process.

The Washington State Department of Ecology (Ecology), Dam Safety Office web address is:

<https://ecology.wa.gov/Water-Shorelines/Water-supply/Dams>

### **Side Slopes**

Interior side slopes up to the emergency overflow water surface should not be steeper than 3H:1V unless a fence is provided (see [Fencing](#)).

Exterior side slopes should not be steeper than 2H:1V unless analyzed for stability by a licensed engineer in the state of Washington with geotechnical expertise.

Pond walls may be vertical retaining walls, provided that (a) they are constructed of reinforced concrete; (b) a fence is provided along the top of the wall; (c) the entire pond perimeter may be retaining walls; however, it is recommended that  $\geq 25\%$  of the pond perimeter be a vegetated soil slope  $< 3H:1V$ ; and (d) the design is stamped by a licensed engineer in the state of Washington with structural expertise. Other retaining walls such as rockeries, concrete, masonry unit walls, and keystone-type wall may be used if designed by a licensed engineer in the state of Washington with geotechnical expertise or a licensed engineer in the state of Washington with structural expertise. If the entire pond perimeter is to be retaining walls, ladders should be provided on the walls for safety reasons.

## **Embankments**

Pond berm embankments higher than 6 feet must be designed by a licensed engineer in the state of Washington with geotechnical expertise.

For berm embankments  $\leq 4$  feet high, the minimum top width should be 4 feet or as recommended by a licensed engineer in the state of Washington with geotechnical expertise.

Pond berm embankments must be constructed on native consolidated soil (or adequately compacted and stable fill soils analyzed by a licensed engineer in the state of Washington with geotechnical expertise) free of loose surface soil materials, roots, and other organic debris.

Pond berm embankments  $> 4$  feet in height must be constructed by excavating a key equal to 50% of the berm embankment cross-sectional height and width unless specified otherwise by a licensed engineer in the state of Washington with geotechnical expertise.

Embankment compaction should be accomplished in such a manner as to produce a dense, low-permeability engineered fill that can tolerate postconstruction settlements with a minimum of cracking. The embankment fill should be placed on a stable subgrade and compacted to a minimum of 95% of the modified Proctor maximum density, ASTM Procedure D1557. Placement moisture content should lie within 1% dry to 3% wet of the optimum moisture content. The referenced degree of compaction may have to be increased to comply with local regulations.

The berm embankment should be constructed of soils with the following characteristics: a minimum of 20% silt and clay, a maximum of 60% sand, a maximum of 60% silt, with nominal gravel and cobble content. Soils outside this specified range can be used, provided the design satisfactorily addresses the engineering concerns posed by these soils. The paramount concerns with these soils are their susceptibility to internal erosion or piping and to surface erosion from wave action and runoff on the upstream and downstream slopes, respectively. Antiseepage filter-drain diaphragms must be placed on outflow pipes in berm embankments impounding water with depths  $> 8$  feet at the design water surface.

**For more information:** See Ecology's Dam Safety guidelines web page at the following address:

<https://ecology.wa.gov/Water-Shorelines/Water-supply/Dams>

## **Overflow**

- In all ponds, tanks, and vaults, a primary overflow (usually a riser pipe within the control structure; see [6.2.6 Control Structures](#)) must be provided to bypass the 25-year developed

peak flow over or around the restrictor system. This assumes the BMP will be full due to plugged orifices or high inflows; the primary overflow is intended to protect against breaching of a pond embankment (or overflows of the upstream conveyance system in the case of a detention tank or vault). The design must provide controlled discharge directly into the downstream conveyance system or another acceptable discharge point.

- A secondary inlet to the control structure should be provided in ponds as additional protection against overtopping should the inlet pipe to the control structure become plugged. A grated opening (“jailhouse window”) in the control structure manhole functions as a weir (see [Figure 6.2: Typical Detention Pond Sections](#)) when used as a secondary inlet.
- Note: The maximum circumferential length of this opening must not exceed one-half the control structure circumference. The “birdcage” overflow structure as shown in [Figure 6.3: Overflow Structure](#) may also be used as a secondary inlet.

### **Emergency Overflow Spillway**

Emergency overflow spillways are intended to control the location of pond overtopping in the event of total control structure failure (e.g., blockage of the control structure outlet pipe) or extreme inflows, and direct overflows back into the downstream conveyance system or other acceptable discharge point.

Emergency overflow spillways must be provided for ponds with constructed berms over 2 feet in height, or for ponds located on grades > 5%. As an option for ponds with berms < 2 feet in height and located at grades < 5%, emergency overflow may be provided by an emergency overflow structure, such as a manhole fitted with a birdcage as shown in [Figure 6.3: Overflow Structure](#). The emergency overflow structure must be designed to pass the 25-year developed peak flow, with a minimum 6 inches of freeboard, directly to the downstream conveyance system or another acceptable discharge point. Where an emergency overflow spillway would discharge to a steep slope, consideration should be given to providing an emergency overflow structure in addition to the spillway.

The emergency overflow spillway must be armored with riprap or other suitable material. The full length of the spillway must be armored, beginning at a point midway across the berm embankment and extending downstream to where emergency overflows reenter the conveyance system (see [Figure 6.2: Typical Detention Pond Sections](#)).

**For more information:** Guidance for the design of the riprap can be found in Hydraulic Engineering Circular No. 11 (HEC-11), *Design of Riprap Revetment* ([FHWA, 1989](#)), and HEC-14, *Hydraulic Design of Energy Dissipators for Culverts and Channels* ([FHWA, 2006](#)).

Emergency overflow spillway designs should be analyzed as broad-crested trapezoidal weirs.

### **Access**

The following guidelines for access may be used:

- Maintenance access road(s) should be provided to the control structure and other drainage structures associated with the pond (e.g., inlet or bypass structures). It is recommended that manhole and catch basin lids be located in or at the edge of the access road and  $\geq 3$  feet from

a property line.

- An access ramp is needed for removal of sediment with a trackhoe and truck. The ramp should extend to the pond bottom if the pond bottom is > 1,500 square feet (sf), excluding the ramp, and it may end at an elevation 4 feet above the pond bottom, if the pond bottom is < 1,500 sf, excluding the ramp).
- On large, deep ponds, truck access to the pond bottom via an access ramp is necessary so loading can be done in the pond bottom. On small deep ponds, the truck can remain on the ramp for loading. On small shallow ponds, a ramp to the bottom may not be required if the trackhoe can load a truck parked at the pond edge or on the internal berm of a wetpond or combined pond (trackhoes can negotiate interior pond side slopes).
- Access ramps must meet the requirements for design and construction of access roads specified below.
- If a fence is required, access should be limited by a double-posted gate or by bollards – that is, two fixed bollards on each side of the access road and two removable bollards equally located between the fixed bollards.

### **Design of Access Roads**

The design guidelines for access road are as follows:

- Maximum grade should be 20%.
- Outside turning radius should be a minimum of 40 feet.
- Fence gates should be located only on straight sections of road.
- Access roads should be 15 feet in width on curves and 12 feet on straight sections.
- The drivable surface should have a 20-year design life to carry the load of a 24-ton truck; assume three trips per year.
- A paved apron must be provided where access roads connect to paved public roadways.
- A truck turnaround is required at the terminus of the road.

### **Construction of Access Roads**

Access roads may be constructed with an asphalt or gravel surface, or modular grid pavement. All surfaces must conform to the jurisdictional standards and manufacturer's specifications.

### **Fencing**

A fence may also be needed around impoundments of open water. See the Uniform Building Code or local building codes for fencing requirements in these areas.

### **Sediment Depth Marker**

Consider providing a fixed vertical sediment depth marker installed in the structure to measure sediment deposition over time.

### **Right-of-Way**

Right-of-way may be needed for detention pond maintenance. It is recommended that any tract not abutting public right-of-way have 15- to 20-foot-wide extension of the tract to an acceptable access location.

### **Setbacks**

It is recommended that the ponded area be a minimum of 20 feet from any structure, property line, and any vegetative buffer required by the local jurisdiction. Side slopes for the pond or berm should be a minimum of 5 feet from any structure or property line. The detention pond water surface at the pond outlet invert elevation must be set back 100 feet from proposed or existing septic system drain fields. However, the setback requirements are generally specified by the local jurisdiction, Uniform Building Code, or other statewide regulation, and may be different from those mentioned above.

The design professional should carefully consider and evaluate any situation where an infiltration BMP will be situated upslope from a structure or behind the top of a slope > 15%. The minimum setback from such a slope is equal to the height of the slope (h), unless the design professional can justify a lesser setback based on a comprehensive site evaluation.

### **Seeps and Springs**

Intermittent seeps along cut slopes are typically fed by a shallow ground water source (interflow) flowing along a relatively impermeable soil stratum. These flows are storm driven and should discontinue after a few weeks of dry weather. However, more continuous seeps and springs, which extend through longer dry periods, are likely from a deeper ground water source. When continuous flows are intercepted and directed through flow control BMPs, adjustments to the BMP design may have to be made to account for the additional base flow (unless already considered in design).

### **Planting Requirements**

Exposed earth on the pond bottom and interior side slopes may be sodded or seeded with an appropriate seed mixture. All remaining areas of the tract may be planted with grass or be landscaped.

**For more information:** See [BMP C120E: Temporary and Permanent Seeding](#) for typical seed mixes.

### **Landscaping**

If provided, landscaping should adhere to the criteria that follow so as not to hinder maintenance operations. Landscaped stormwater tracts may, in some instances, provide a recreational space. In other instances, “naturalistic” stormwater BMPs may be placed in open space tracts.

The following guidelines should be followed if landscaping is proposed for BMPs:

- No trees or shrubs may be planted within 10 feet of inlet or outlet pipes or drainage structures such as spillways or flow spreaders. Species with roots that seek water, such as willow or poplar, should be avoided within 50 feet of pipes or structures.
- Planting should be restricted on berms that impound water either permanently or temporarily during storms. This restriction does not apply to cut slopes that form pond banks, only to berms.
  - Trees or shrubs may not be planted on portions of water impounding berms taller than 4 feet high. Only grasses may be planted on berms taller than 4 feet.

**Note:** Grasses allow unobstructed visibility of berm slopes for detecting potential dam safety problems such as animal burrows, slumping, or fractures in the berm.

- Trees planted on portions of water-impounding berms < 4 feet high must be small, ≤ 20 feet mature height, and have a fibrous root system.
 

**Note:** These trees reduce the likelihood of tree blowdown, or the possibility of channeling or piping of water through the root system, which may contribute to dam failure on berms that retain water.
- All landscape material, including grass, should be planted in good topsoil. Native underlying soils may be made suitable for planting if amended with 4 inches of well-aged compost tilled into the subgrade. Compost used should meet specifications in [Chapter 173-350 WAC](#).
- Soil in which trees or shrubs are planted may need additional enrichment or additional compost topdressing. Consult a nursery person, landscape professional, or arborist for site-specific recommendations.
- For a naturalistic effect as well as ease of maintenance, trees or shrubs should be planted in clumps to form “landscape islands” rather than evenly spaced.

**Note:** The landscaped islands should be a minimum of 6 feet apart, and if set back from fences or other barriers, the setback distance should also be a minimum of 6 feet. Where tree foliage extends low to the ground, the 6-foot setback should be counted from the outer dripline of the trees (estimated at maturity). This setback allows a 6-foot-wide mower to pass around and between clumps.

- Evergreen trees and trees that produce relatively little leaf fall (such as ash, locust, and hawthorn) are preferred in areas draining to the pond.
- Trees should be set back so that branches do not overhang the pond (to prevent leaf fall into the water). Drought-tolerant species are recommended.

## ***Design Procedure***

### **Detention Volume and Outflow**

The volume and outflow design for detention ponds must be in accordance with the requirements of [2.7.7 Core Element #6: Flow Control](#) and the hydrologic analysis and design methods in Chapter 4. Design guidelines for restrictor orifice structures are given in [6.2.6 Control Structures](#).

**Note:** The design water surface elevation is the highest elevation which occurs in order to meet the required outflow performance for the pond.

### **Detention Ponds in Infiltrative Soils**

Detention ponds may occasionally be sited on soils that are sufficiently permeable for a properly functioning infiltration system. These detention ponds have a surface discharge and may also use infiltration as a second pond outflow. Detention ponds sized with infiltration as a second outflow must meet all the requirements of [6.3 Infiltration BMPs](#) for infiltration ponds, including a soils report, testing, ground water protection, presettling, and construction techniques.

### **Emergency Overflow Spillway Capacity**

For impoundment volumes < 10 acre-feet, the emergency overflow spillway weir section must be designed to safely convey the 25-year runoff event for developed conditions assuming a broad-crested weir. The broad-crested weir equation for the spillway section in [Figure 6.4: Weir Section for Emergency Overflow Spillway](#), for example, would be:

#### **Equation 6.1: Broad-Crested Weir Flow**

$$Q_{25} = C(2g)^{1/2} \left[ \frac{2}{3} LH^{3/2} + \frac{8}{15} (\tan\theta) H^{5/2} \right]$$

where:

$Q_{25}$  = peak flow for the 25-year runoff event (cfs)

C = discharge coefficient (0.6)

g = gravity (32.2 ft/sec<sup>2</sup>)

L = length of weir (ft)

H = height of water over weir (ft)

$\theta$  = angle of side slopes

Assuming:

- C = 0.6
- $\tan\theta = 3$  (for 3:1 slopes)

The equation becomes:

#### **Equation 6.2: Broad-Crested Weir Flow for 3:1 Slopes**

$$Q_{25} = 3.21 * [L * H^{3/2} + 2.4 * H^{5/2}]$$

To find length (L) for the weir section, the equation is rearranged to use the computed  $Q_{25}$  and trial values of H (0.2 feet minimum):

#### **Equation 6.3: Broad-Crested Weir Length**



$$L = [Q_{25} / (3.21 * H^{3/2})] - 2.4 * H; \text{ or } L = 6 \text{ feet minimum}$$

## ***Operation and Maintenance Criteria***

### **General**

Maintenance is of primary importance if detention ponds are to continue to function as originally designed. A local jurisdiction, a designated group such as a homeowners' association, or some individual should accept the responsibility for maintaining the structures and the impoundment area. A specific maintenance plan should be formulated outlining the schedule and scope of maintenance operations. Debris removal in detention basins can be achieved through the use of trash racks or other screening devices.

### **Design With Maintenance in Mind**

Good maintenance will be crucial to successful use of the impoundment. Hence, provisions to facilitate maintenance operations must be built into the project when it is installed. Maintenance should be a basic consideration in design and in determination of first cost. See [Appendix 6-A: Recommended Maintenance Criteria for Flow Control BMPs](#) for specific maintenance recommendations.

Any standing water removed during the maintenance operation must be disposed of to a sanitary sewer at an approved discharge location. Pretreatment may be necessary. Residuals must be disposed of in accordance with state and local solid waste regulations (see Minimum Functional Standards for Solid Waste Handling [[Chapter 173-304 WAC](#)]).

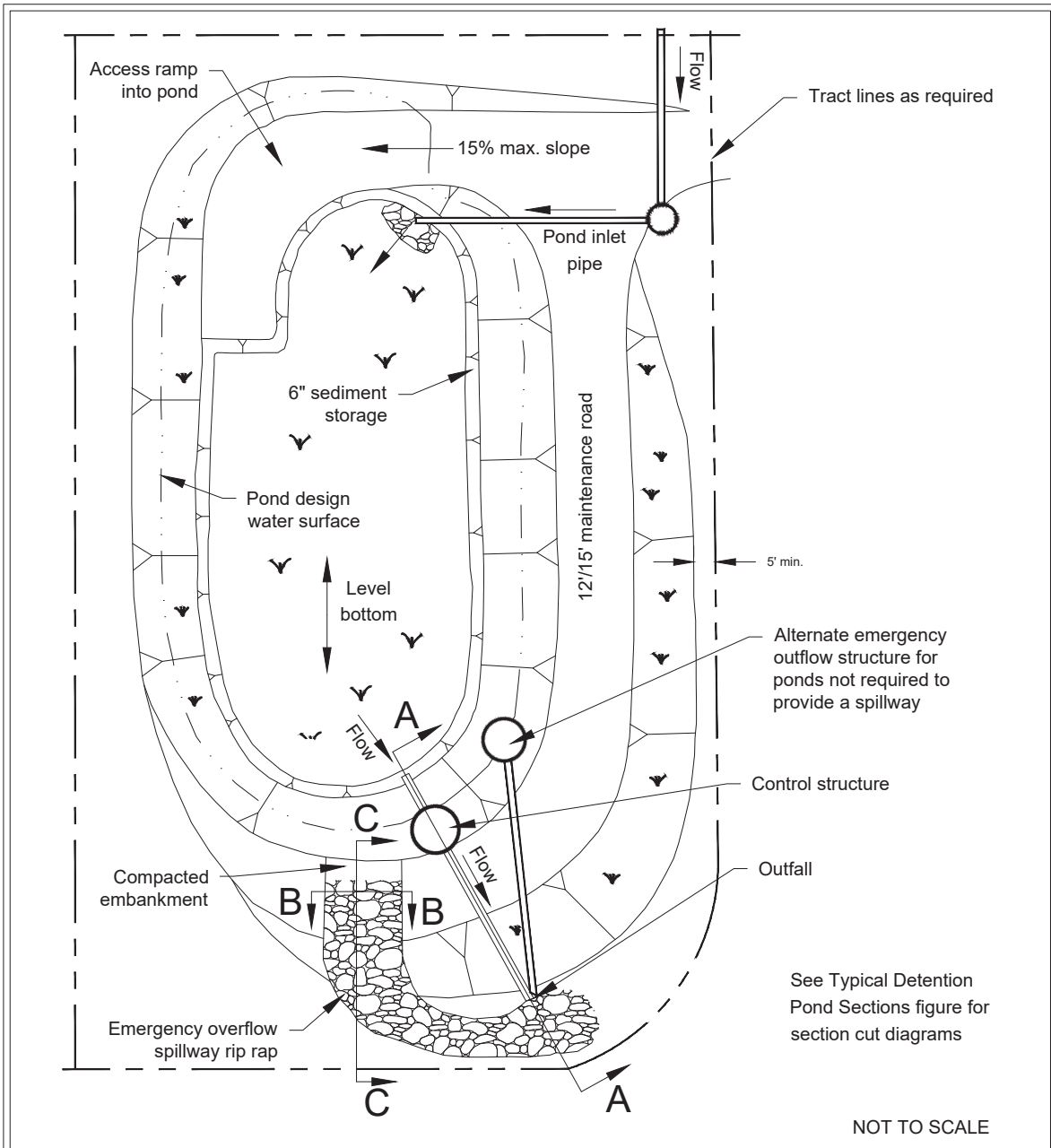
### **Vegetation**

If a shallow marsh is established, then periodic removal of dead vegetation may be necessary. Since decomposing vegetation can release pollutants captured in the detention pond, especially nutrients, it may be necessary to harvest dead vegetation annually prior to the winter season. Otherwise the decaying vegetation can export pollutants out of the pond and can cause nuisance conditions to occur.

### **Sediment**

Maintenance of sediment forebays and attention to sediment accumulation within the pond is extremely important. Sediment deposition should be periodically monitored in the basin. Owners, operators, and maintenance authorities should be aware that significant concentrations of metals (e.g., lead, zinc, and cadmium) as well as some organics such as pesticides, may be expected to accumulate at the bottom of these treatment BMPs. Testing of sediment, especially near points of inflow, should be conducted periodically to determine the leaching potential and level of accumulation of potentially hazardous material before disposal.

**Figure 6.1: Typical Detention Pond**

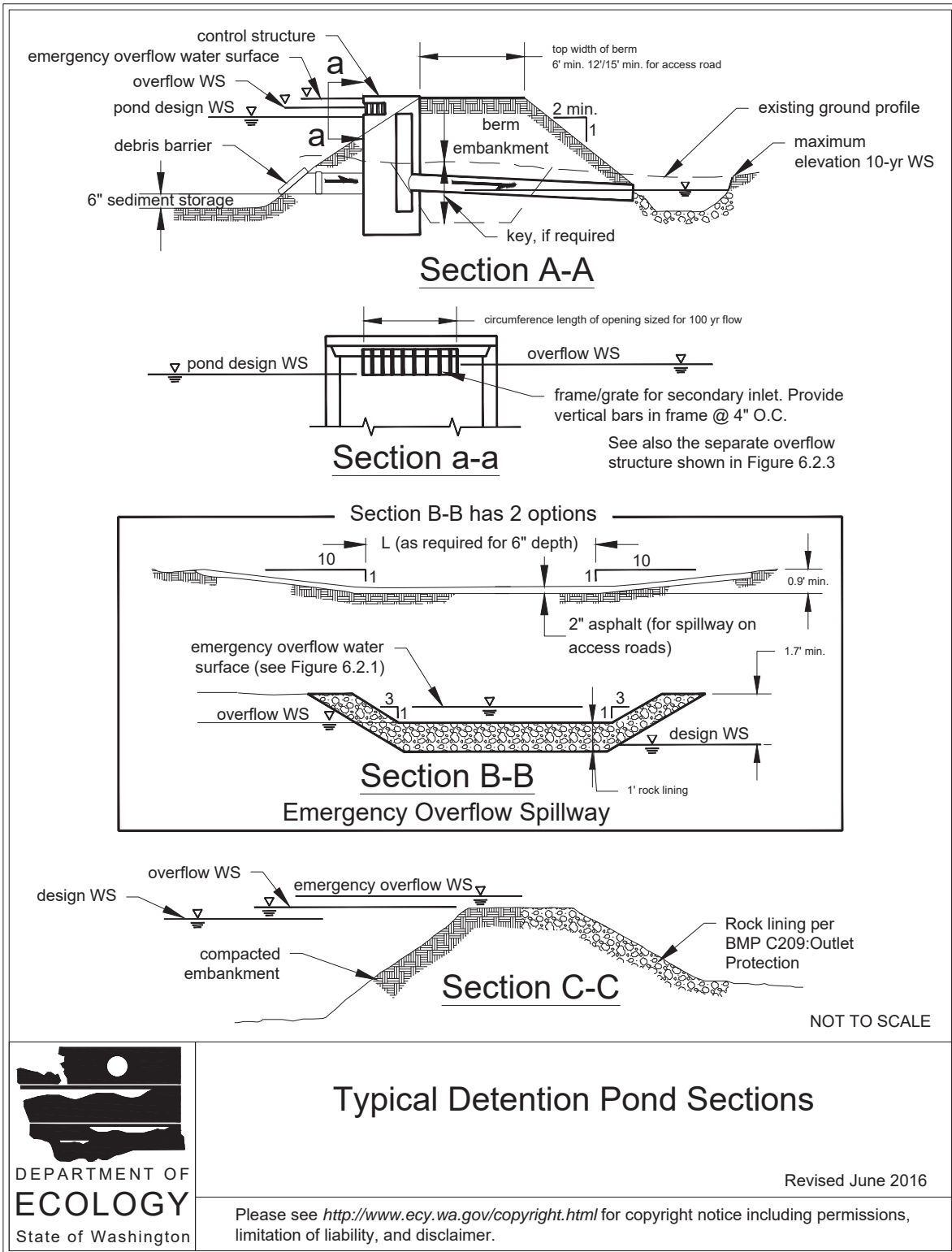


## Typical Detention Pond

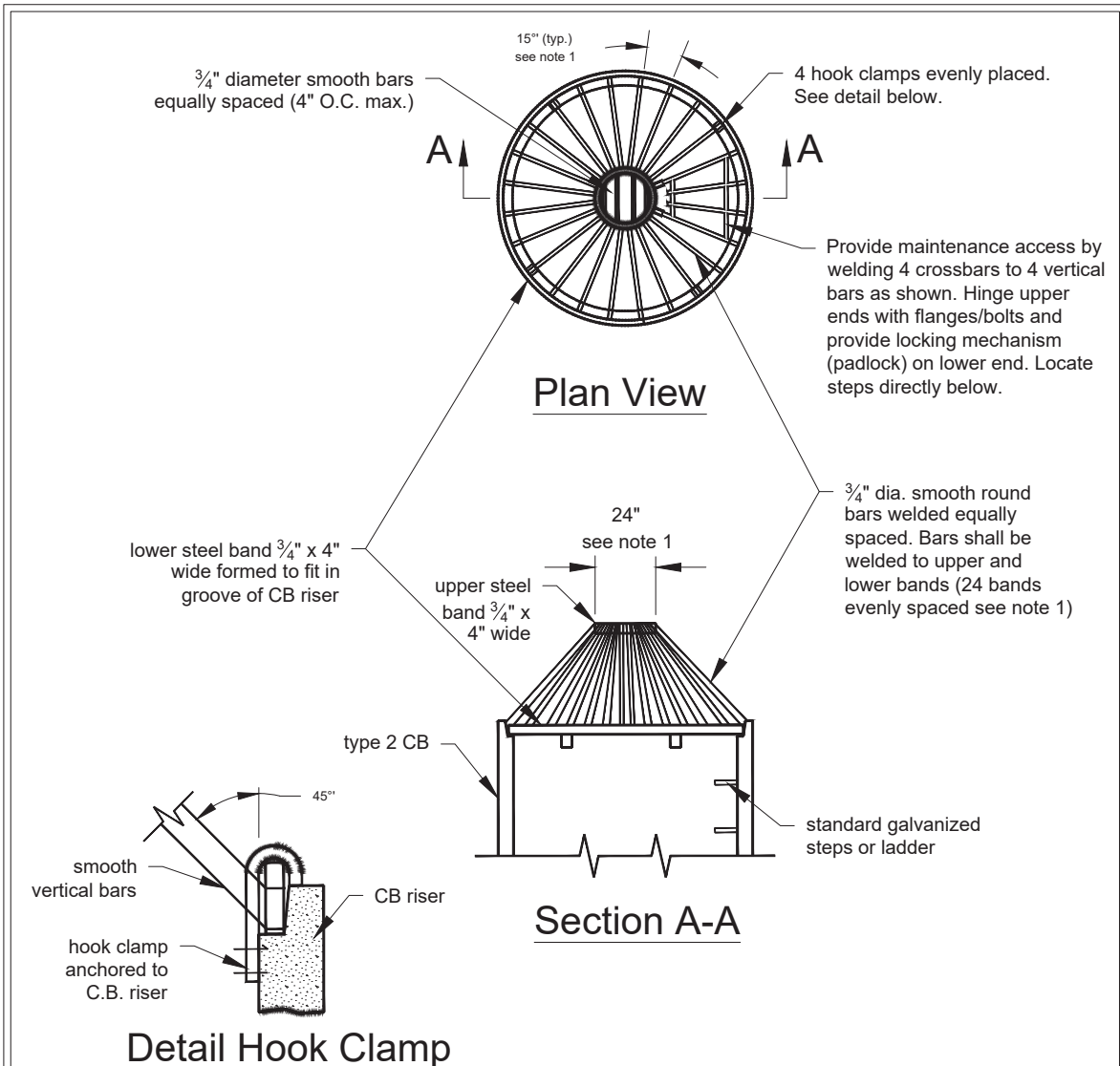
Revised June 2016

Please see <http://www.ecy.wa.gov/copyright.html> for copyright notice including permissions, limitation of liability, and disclaimer.

**Figure 6.2: Typical Detention Pond Sections**



**Figure 6.3: Overflow Structure**



**Notes:**

1. Dimensions are for illustration on 54" diameter CB. For different diameter CB's adjust to maintain 45 degree angle on "vertical" bars and 7" O.C. maximum spacing of bars around lower steel band.
2. Metal parts must be corrosion resistant; steel bars must be galvanized.
3. This debris barrier is also recommended for use on the inlet to roadway cross-culverts with high potential for debris collection (except on type 2 streams).

NOT TO SCALE

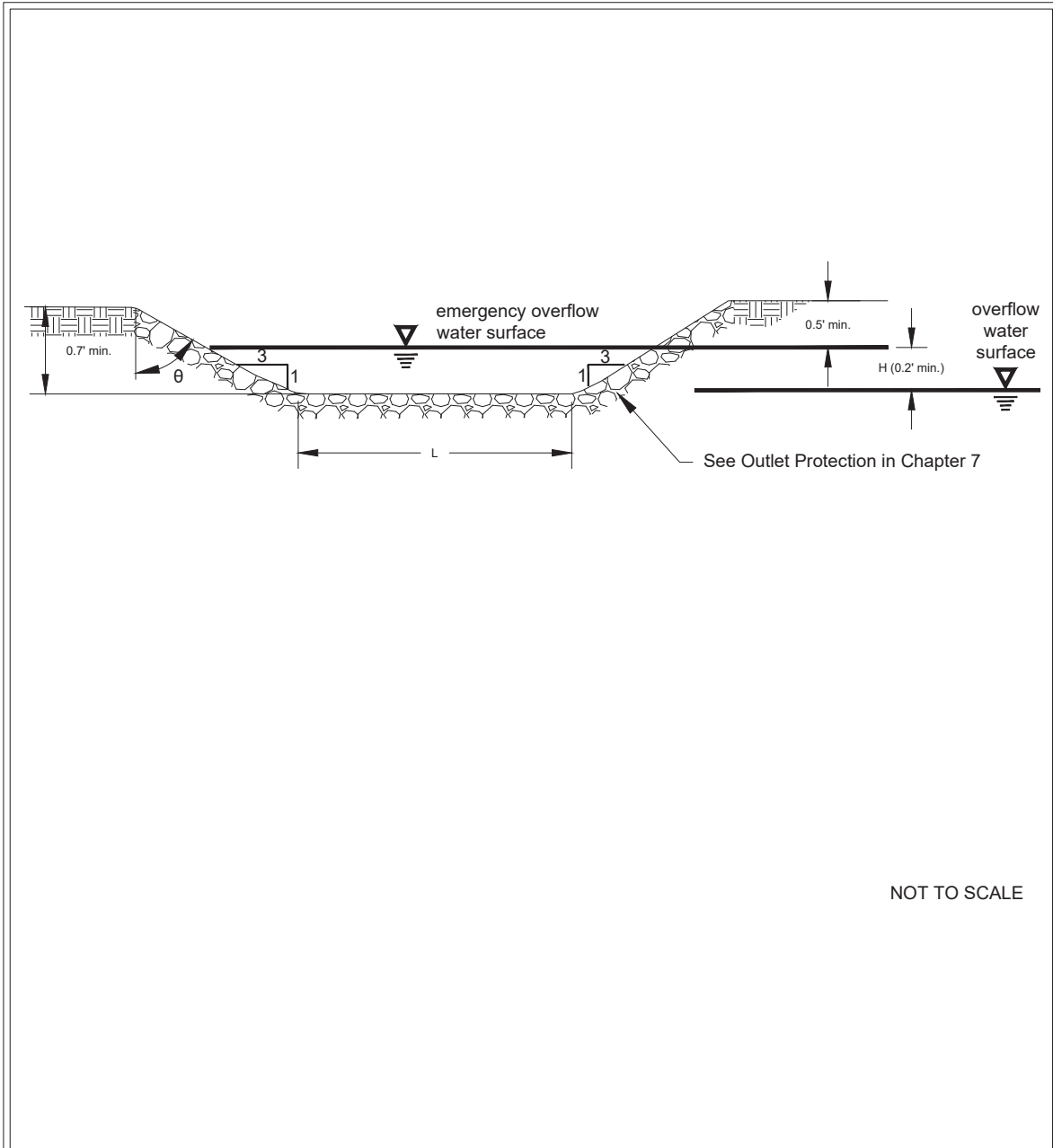


**Overflow Structure**

Revised June 2016

Please see <http://www.ecy.wa.gov/copyright.html> for copyright notice including permissions, limitation of liability, and disclaimer.

**Figure 6.4: Weir Section for Emergency Overflow Spillway**



Weir Section for Emergency Overflow Spillway

Revised June 2016

Please see <http://www.ecy.wa.gov/copyright.html> for copyright notice including permissions, limitation of liability, and disclaimer.

## **BMP F6.11: Detention Tanks**

Detention tanks are underground storage BMPs typically constructed with large diameter corrugated metal pipe. Typical detention tank details are shown in [Figure 6.5: Typical Detention Tank](#) and [Figure 6.6: Detention Tank Access Detail](#). Control structure details are shown in [6.2.6 Control Structures](#). Detention tanks are not subject to Underground Injection Control (UIC) regulations unless the structure at the land surface is smaller than the depth of the outlet pipe and the pipe discharges to ground; [5.6 Subsurface Infiltration \(Underground Injection Control Wells\)](#).

### **General Criteria**

- Tanks may be designed as flow-through systems with maintenance holes in line (see [Figure 6.5: Typical Detention Tank](#)) to promote sediment removal and facilitate maintenance. Tanks may be designed as backup systems if preceded by runoff treatment BMPs, since little sediment should reach the inlet/control structure and low head losses can be expected because of the proximity of the inlet/control structure to the tank.
- The detention tank bottom should be located 0.5 feet below the inlet and outlet to provide dead storage for sediment.
- The minimum pipe diameter for a detention tank is 36 inches.
- Tanks larger than 36 inches may be connected to each adjoining structure with a short section (2-foot maximum length) of 36-inch minimum diameter pipe.

**Note:** Control and access maintenance holes should have ladder rungs to allow ready access to all tank access pipes when the catch basin sump is filled with water.

### **Materials**

Pipe material, joints, and protective treatment for tanks should be in accordance with the latest version of the WSDOT/APWA Standard Specifications.

### **Structural Stability**

Tanks must meet structural requirements for overburden support and traffic loading if appropriate. H-20 live loads, or other loading criteria applicable to the site, must be accommodated for tanks lying under parking areas and access roads. Metal tank end plates must be designed for structural stability at maximum hydrostatic loading conditions. Flat-end plates generally require thicker gauge material than the pipe and/or require reinforcing ribs. Tanks must be placed on stable, well-consolidated native material with suitable bedding. Tanks must not be placed in fill slopes, unless analyzed in a geotechnical report for stability and constructability.

### **Buoyancy**

In moderately pervious soils where seasonal ground water may induce flotation, buoyancy tendencies must be balanced either by ballasting with backfill or concrete backfill, providing concrete anchors, increasing the total weight, or providing subsurface drains to permanently lower the ground water table. Calculations that demonstrate stability must be documented.

## **Access**

The following guidelines for access may be used:

- The maximum depth from finished grade to tank invert should be 20 feet.
- Access openings should be positioned a maximum of 50 feet from any location within the tank.
- All tank access openings should have round, solid locking lids (usually 1/2- to 5/8-inch-diameter Allen-head cap screws).
- 36-inch minimum diameter corrugated metal pipe (CMP) riser-type maintenance holes (see [Figure 6.6: Detention Tank Access Detail](#)) of the same gauge as the tank material may be used for access along the length of the tank and at the upstream terminus of the tank in a backup system. The top slab is separated (1-inch minimum gap) from the top of the riser to allow for deflections from vehicle loadings without damaging the riser tank.
- All tank access openings must be readily accessible by maintenance vehicles.
- Tanks must comply with the Occupational Safety and Health Administration (OSHA) confined space requirements, which includes clearly marking entrances to confined space areas. This may be accomplished by hanging a removable sign in the access riser(s), just under the access lid.

## **Access Roads**

Access roads are needed to all detention tank control structures and risers. The access roads must be designed and constructed as specified for detention ponds in [6.2 Detention BMPs](#).

## **Right-of-Way**

Right-of-way may be needed for detention tank maintenance. It is recommended that any tract not abutting public right-of-way have a 15- to 20-foot-wide extension of the tract to accommodate an access road to the detention tank.

## **Setbacks**

It is recommended that detention tanks be a minimum of 5 feet from any structure, property line, and any vegetative buffer required by the local jurisdiction and from any septic drain field. However, the setback requirements are generally specified by the local jurisdiction, Uniform Building Code, or other statewide regulation and may be different from those mentioned above.

Provisions to facilitate maintenance operations must be built into the project when it is installed. Maintenance must be a basic consideration in design and in determination of first cost.

**For more information:** See [Appendix 6-A: Recommended Maintenance Criteria for Flow Control BMPs](#).

## ***Design Procedure***

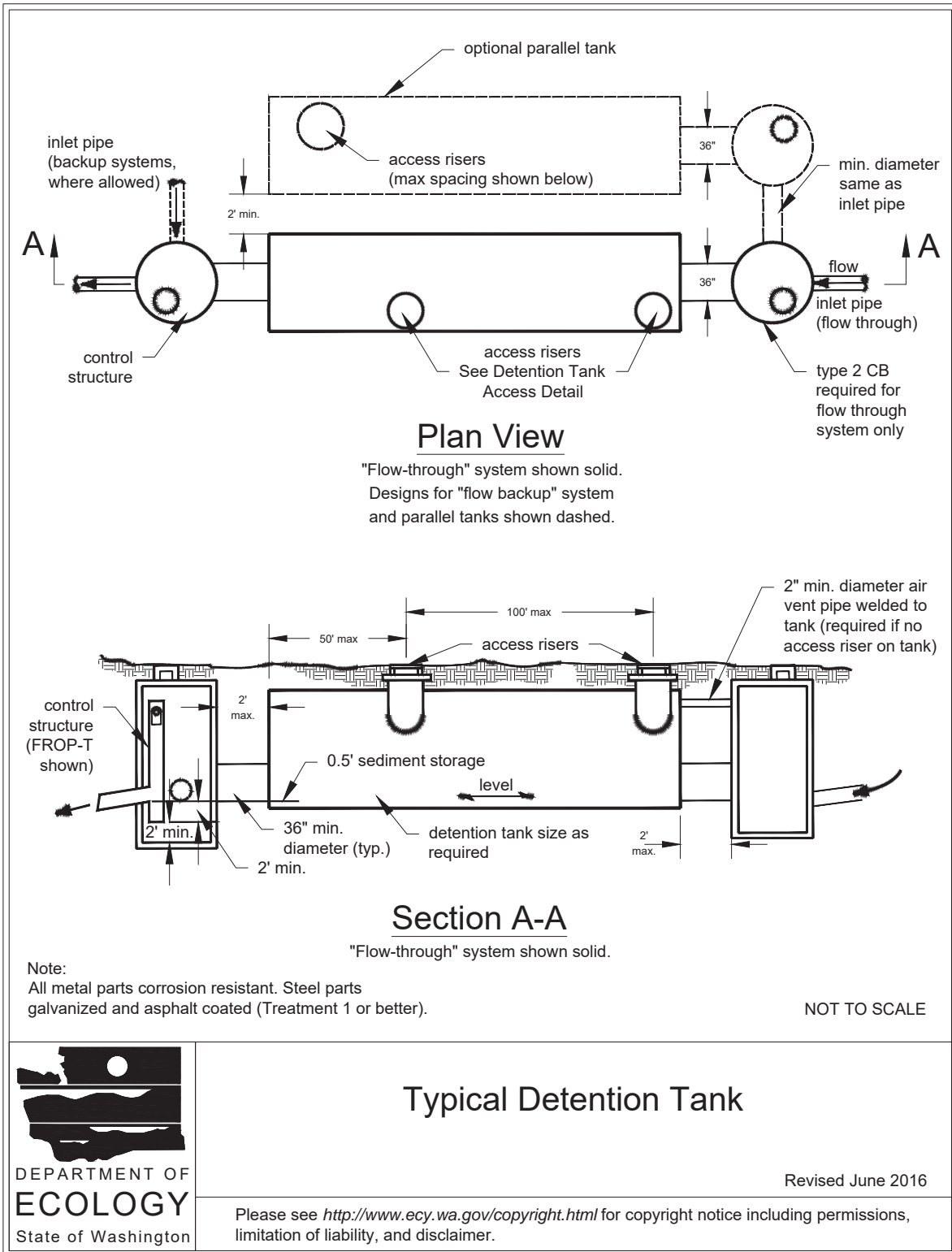
The volume and outflow design for detention tanks must be in accordance with the requirements of the regulatory agency and the hydrologic analysis and design methods in Chapter 4. Restrictor and orifice design criteria are provided in [6.2.6 Control Structures](#).

## ***Operation and Maintenance Criteria***

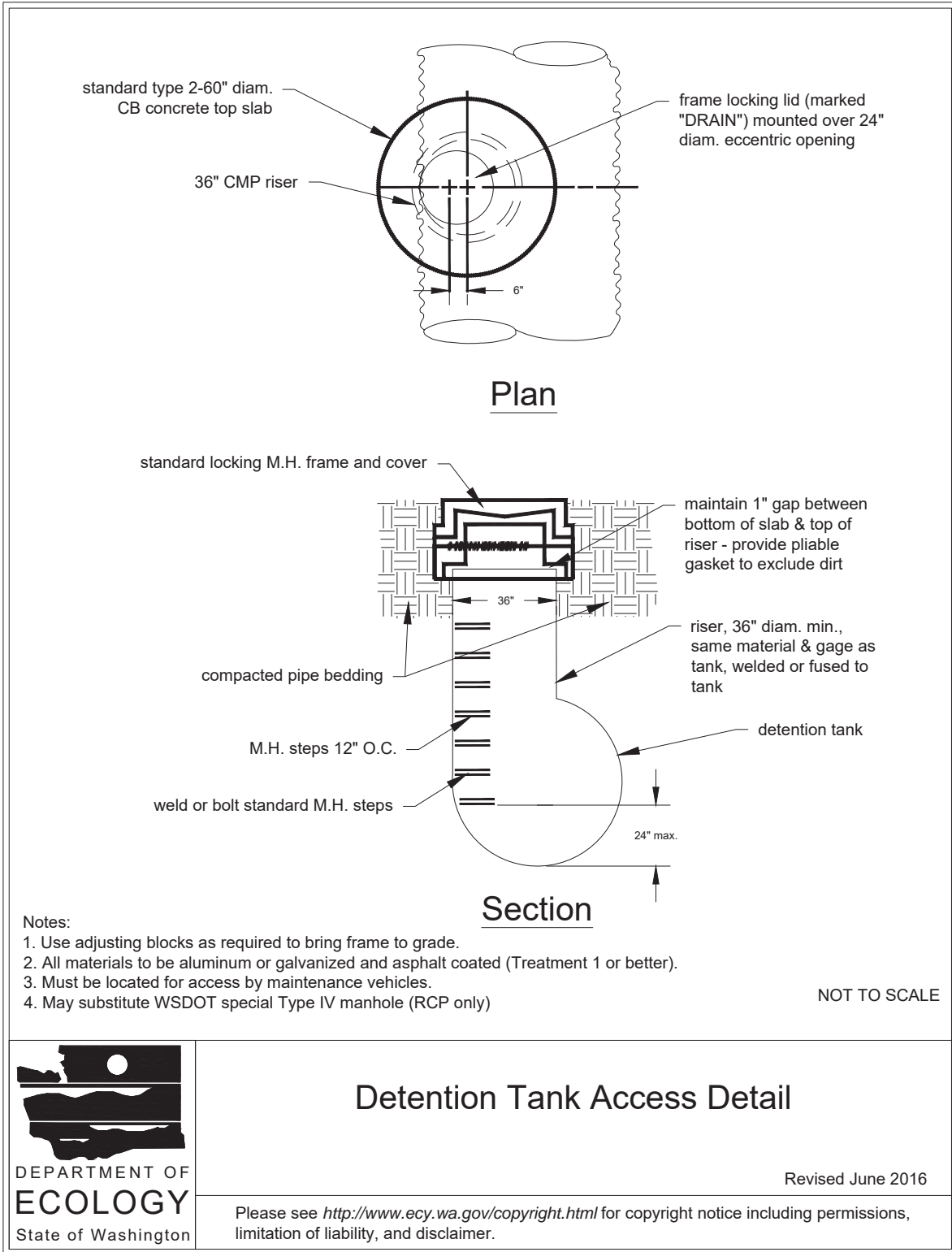
Provisions to facilitate maintenance operations must be built into the project when it is installed. Maintenance must be a basic consideration in design and in determination of first cost. See [Appendix 6-A: Recommended Maintenance Criteria for Flow Control BMPs](#) for specific maintenance recommendations.



**Figure 6.5: Typical Detention Tank**



**Figure 6.6: Detention Tank Access Detail**



## **BMP F6.12: Detention Vaults**

Detention vaults are box-shaped underground storage BMPs typically constructed with reinforced concrete. A standard detention vault detail is shown in [Figure 6.7: Typical Detention Vault](#). Control structure details are shown in [6.2.6 Control Structures](#). Detention vaults are not subject to Underground Injection Control (UIC) regulations unless the structure at the land surface is smaller than the depth of the outlet pipe *and* the pipe discharges to ground; see [5.6 Subsurface Infiltration \(Underground Injection Control Wells\)](#).

### **General Criteria**

General design guidelines are as follows:

- Detention vaults may be designed as flow-through systems with bottoms level (longitudinally) or sloped toward the inlet to facilitate sediment removal. Distance between the inlet and outlet should be maximized (as feasible).
- The detention vault bottom should slope  $\geq 5\%$  from each side towards the center, forming a broad “v” to facilitate sediment removal. More than one “v” may be used to minimize vault depth. However, the vault bottom may be flat with 0.5 to 1 foot of sediment storage if removable panels are provided over the entire vault. It is recommended that the removable panels be at grade, have stainless steel lifting eyes, and weigh  $\leq 5$  tons per panel.
- The invert elevation of the outlet should be elevated above the bottom of the vault to provide an average 6 inches of sediment storage over the entire bottom. The outlet should also be elevated a minimum of 2 feet above the orifice to retain oil within the vault.

### **Materials**

Minimum 3,000 pounds per square inch (psi) structural reinforced concrete may be used for detention vaults. All construction joints must be provided with water stops.

### **Structural Stability**

All vaults must meet structural requirements for overburden support and H-20 traffic loading (see the latest version of the Standard Specifications for Highway Bridges, American Association of State Highway and Transportation Officials [AASHTO]). Vaults located under roadways must meet any live load requirements of the local jurisdiction. Cast-in-place wall sections must be designed as retaining walls. Structural designs for cast-in-place vaults must be stamped by a licensed engineer in the state of Washington with structural expertise. Vaults must be placed on stable, well-consolidated native material with suitable bedding. Vaults must not be placed in fill slopes, unless analyzed in a geotechnical report for stability and constructability.

### **Access**

Access must be provided over the inlet pipe and outlet structure. The following guidelines for access may be used.

1. Access openings should be positioned a maximum of 50 feet from any location within the tank. Additional access points may be needed on large vaults. If more than one “v” is provided in the vault floor, access to each “v” must be provided.
2. For vaults with > 1,250 square feet of floor area, a 5- by 10-foot removable panel should be provided over the inlet pipe (instead of a standard frame, grate and solid cover). Alternatively, a separate access vault may be provided.
3. For vaults under roadways, the removable panel must be located outside the travel lanes. Alternatively, multiple standard locking manhole covers may be provided. Ladders and handholds need only be provided at the outlet pipe and inlet pipe, and as needed to meet the Occupational Safety and Health Administration (OSHA) confined space requirements. Vaults providing manhole access at 12-foot spacing need not provide corner ventilation pipes as specified in Item 10 below.
4. All access openings, except those covered by removable panels, may have round, solid locking lids, or 3-foot-square locking diamond plate covers.
5. Vaults with widths  $\leq$  10 feet must have removable lids.
6. The maximum depth from finished grade to the vault invert should be 20 feet.
7. Internal structural walls of large vaults should be provided with openings sufficient for maintenance access between cells. The openings should be sized and situated to allow access to the maintenance “v” in the vault floor.
8. The minimum internal height should be 7 feet from the highest point of the vault floor (not sump), and the minimum width should be 4 feet. However, concrete vaults may be a minimum 3 feet in height and width if used as tanks with access maintenance holes at each end, and if the width is no larger than the height. Also, the minimum internal height requirement may not be needed for any areas covered by removable panels.
9. Vaults must comply with the OSHA confined space requirements, which include clearly marking entrances to confined space areas. This may be accomplished by hanging a removable sign in the access riser(s), just under the access lid.
10. Ventilation pipes (minimum 12-inch-diameter or equivalent) should be provided in all four corners of vaults to allow for artificial ventilation prior to entry of maintenance personnel into the vault. Alternatively, removable panels over the entire vault may be provided.

### **Access Roads**

Access roads are needed to the access panel (if applicable), the control structure, and at least one access point per cell, and they may be designed and constructed as specified for detention ponds in [6.2 Detention BMPs](#).

### **Right-of-Way**

Right-of-way is needed for detention vaults maintenance. It is recommended that any tract not abutting public right-of-way should have a 15- to 20-foot-wide extension of the tract to accommodate an access road to the detention vault.

## **Setbacks**

It is recommended that detention vaults be a minimum of 20 feet from any structure, property line, and any vegetative buffer required by the local jurisdiction and from any septic drain field. However, the setback requirements are generally specified by the local jurisdiction, uniform building code, or other statewide regulation and may be different from those mentioned above.

The design professional should carefully consider and evaluate any situation where a pond will be situated upslope from a structure or behind the top of a slope inclined  $> 15\%$ . The minimum setback from such a slope is equal to "h," the height of the slope, unless the designer can justify a lesser setback based on a comprehensive site evaluation.

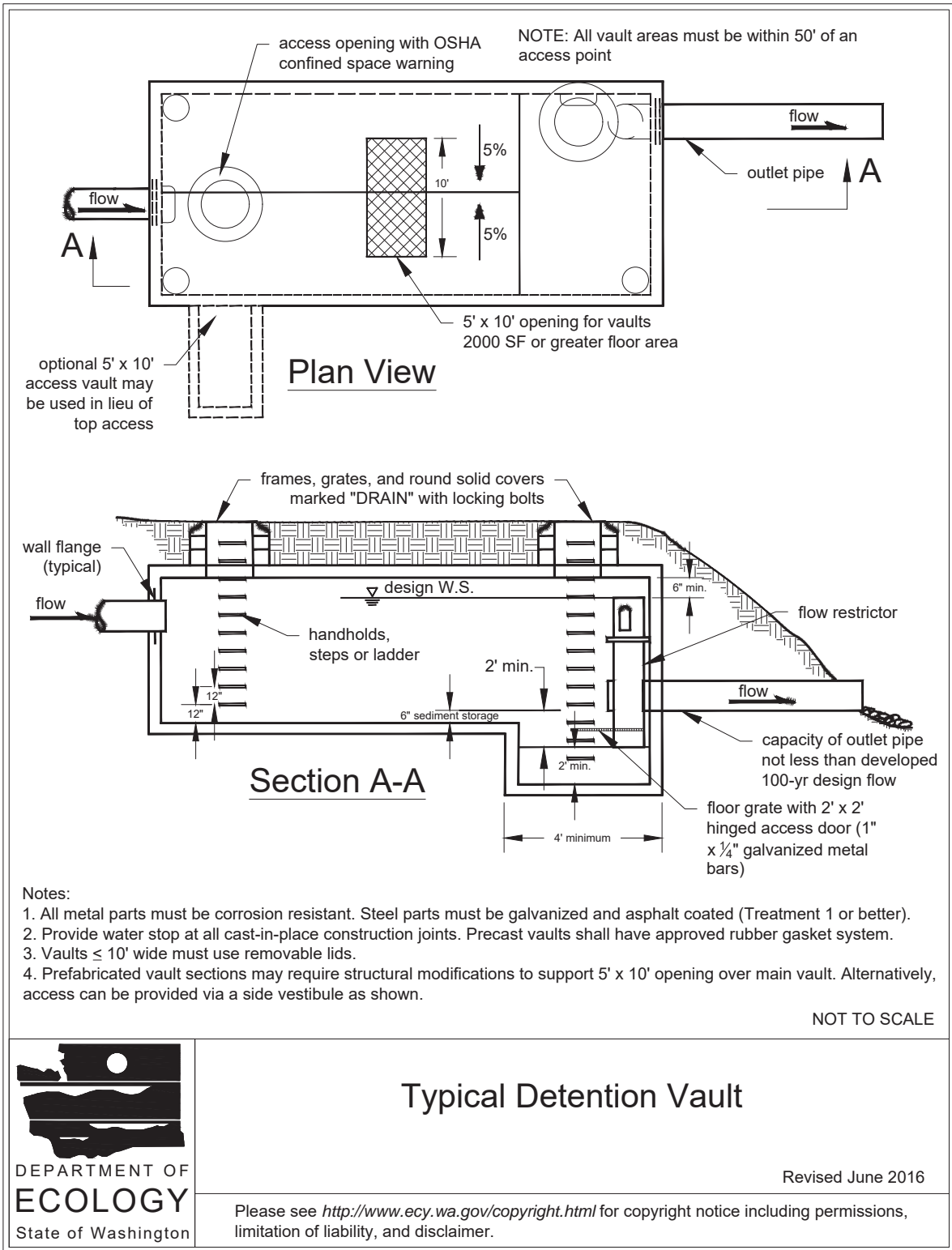
## ***Design Procedure***

The volume and outflow design for detention vaults must be in accordance with the requirements of the regulatory agency and the hydrologic analysis and design methods in [Chapter 4 - Hydrologic Analysis and Design](#). Restrictor and orifice design criteria are provided in [6.2.6 Control Structures](#).

## ***Operation and Maintenance Criteria***

Provisions to facilitate maintenance operations must be built into the project when it is installed. Maintenance must be a basic consideration in design and in determination of first cost. See [Appendix 6-A: Recommended Maintenance Criteria for Flow Control BMPs](#) for specific maintenance recommendations.

**Figure 6.7: Typical Detention Vault**



## **BMP F6.13: Rainwater Harvesting**

Rainwater harvesting has traditionally been used in environments where rainfall or other conditions limit water supply. Many areas of eastern Washington are situated in climate zones where rainwater collection systems, in the form of cisterns, may provide beneficial use.

The well-documented benefits of rainwater harvesting are that it:

- Reduces domestic water demand;
- Serves as CSO reduction strategy;
- Can be used as emergency water for fire suppression;
- Provides a sustainable source for irrigation and nonpotable uses;
- Reduces peak runoff and allows sediment to settle; and
- Provides a water source when ground water is unacceptable or unavailable, or it can augment limited ground water supplies.

Most cisterns are constructed of plastic, steel, or concrete (see [Figure 6.8: Polyethylene Cistern](#) and [Figure 6.9: Cistern Used to Meet Irrigation Requirements](#)). Plastic is commonly used where the cistern material can be protected from the impacts that excessive sunlight can have on warping and algae growth. Plastic cisterns are lightweight, noncorrosive, and relatively inexpensive. Concrete or steel cisterns are sometimes used for aesthetic values and are often custom-designed to complement the scale and character of the structure. In other instances, a simple plastic or steel cistern may be clad with another material for greater aesthetic appeal.

**Figure 6.8: Polyethylene Cistern**



Source: Innovative Water Systems, LLC



## Polyethylene Cistern

Revised June 2013

Please see <http://www.ecy.wa.gov/copyright.html> for copyright notice including permissions, limitation of liability, and disclaimer.



**Figure 6.9: Cistern Used to Meet Irrigation Requirements**



Source: Innovative Water Systems, LLC



## Cistern Used to Meet Irrigation Requirements

Revised June 2013

Please see <http://www.ecy.wa.gov/copyright.html> for copyright notice including permissions, limitation of liability, and disclaimer.

## **General Criteria**

The State Building Code Council adopted the 2015 edition of the Uniform Plumbing Code, which includes governs some aspects of rainwater harvesting (for indoor use only). This code ([WAC 51-56-1600](#)) went into effect July 1, 2016.

The following general design issues should be considered when designing rainwater harvesting systems:

- Rainwater harvesting systems should be sized according to rainfall data (daily or more frequent [sub-daily] data preferred where available) and proposed indoor and outdoor water needs. The sizing of the collection system should only include non-pollution-generating tributary impervious surfaces.
- Cisterns should be covered to prevent mosquito breeding. The cover will protect the water from sunlight and minimize algae growth.
- Screens on the gutter and intake of the outlet pipe should be included to minimize clogging by leaves and other debris.
- Underground cisterns should have tie-downs per manufacturer's specifications to avoid the floating of the cistern resulting from elevated ground water levels.
- Flow control structures, overflows, and clean-outs should be readily accessible and alerts for system problems should be easily visible and audible ([WSU - PSP, 2012](#)).
- Rainwater harvesting systems should only collect water from roof surfaces and not from vehicle or pedestrian areas, stormwater runoff, or bodies of standing water.
- Depending on its size, an aboveground cistern will be treated as a structure under locally adopted building and zoning codes. As a structure, a cistern would need to be set back from property lines and meet local height, bulk, and dimensional standards. Access to the structure may need to meet confined space requirements (check local requirements). The components of a rainwater harvesting system will depend on the rainfall pattern, physical setting, water needs, and stormwater management goals and are described below.

### **Catchment or Roof Area**

The roof material should not contribute contaminants (such as zinc, copper or lead) to the collection system. The National Sanitation Foundation (NSF) certifies products for rainwater collection systems. Products meeting NSF protocol P151 are certified for drinking water system use and do not contribute contaminants at levels greater than those specified in the U.S. Environmental Protection Agency (U.S. EPA) Drinking Water Regulations (40 CFR Parts 141–143) and health advisories ([Stuart, 2001](#)). Guidelines for roofing materials include the following:

- Enamelled standing seam metal, ceramic tile or slate are durable and smooth, presumed to not contribute significant contaminants, and are the preferred materials for potable supply.
- Composition or three-tab roofing should only be used for irrigation catchment systems. Composition roofing is not recommended for irrigation supply if zinc has been applied for moss treatment.

- Lead solder should not be used for roof or gutter construction and existing roofs should be examined for lead content.
- Galvanized surfaces may deliver elevated particulate zinc during initial flushing and elevated dissolved zinc throughout a storm event ([Stuart, 2001](#)) and should not be considered for rainwater collection systems.
- Copper should never be considered for roofing or gutters. When used for roofing material, copper can act as an herbicide if rooftop runoff is used for irrigation. Copper can also be present in toxic amounts if used for a potable source.
- Treated and untreated wood shingles and shakes should not be considered for rainwater collection systems ([WSU - PSP, 2012](#)).

### **Gutters and Downspouts**

Gutters are commonly made from aluminum, galvanized steel, and plastic. Rainwater is slightly acidic; accordingly, collected water entering the cistern should be evaluated for metals or other contaminants associated with the roof and gutters. See the Harvested Rainwater Treatment section for appropriate filters and disinfection techniques. Do not use lead solder for gutter seams. Copper or zinc gutters and downspouts shall not be used; however, if existing gutters and downspouts are already in place, the interior shall be coated with NSF-quality epoxy paint.

Screens should be installed in the top of each downspout. Screens installed on gutters prevent coarse (e.g., leaves and needles), but not fine debris (pollen and dust) from entering the gutter. Gutters will still require cleaning and access should be considered when selecting gutter screens.

### **First Flush Diverters**

First flush diverters collect and route the first flush away from the collection system. The initial flow from a storm can contain higher levels of contaminants from particulates settling on the roof (e.g., bird droppings). A simple diverter consists of a downspout (located upstream of the downspout to the cistern) and a pipe that is fitted and sealed so that water does not back flow into the gutter. Once the pipe is filled, water flows to the cistern downspout. The pipe often extends to the ground and has a clean out and valve ([WSU - PSP, 2012](#)).

The *Texas Manual on Rainwater Harvesting* recommends that the first 10 gallons of water be diverted for every 1,000 square feet (sf) of roof (applicable for areas with higher storm intensities) (Texas Water Development Board, 2005). However, local factors such as rainfall frequency, intensity, and pollutants will influence the amount of water diverted. In areas with low precipitation and lower storm intensities, roof washing may divert flows necessary to support system demands.

### **Roof Washers**

Roof washers are placed just before the storage cistern to filter coarse and fine debris. Washers consist of a tank (typically 30 to 50 gallons), a coarse filter/strainer for leaves and other organic material, and a finer filter (typically  $\leq 30$  microns). Roof washers should be cleaned regularly to prevent clogging as well as prevent the development of pathogens ([Texas Water Development Board, 2005](#)).

All rainwater harvesting systems using impervious roof surfaces shall have at least one roof washer per downspout or prefiltration system. A roof washer or prefiltration system is not required for pervious roof surfaces such as vegetated roofs. Roof washers and prefiltration systems shall meet the following design requirements:

- All collected rainwater shall pass through a roof washer or prefiltration system before the water enters the cistern(s).
- If more than one cistern is used, a roof washer or prefiltration system shall be provided for each cistern. The exception is a series of cisterns interconnected to supply water to a single system.
- The inlet to the roof washer shall be provided with a debris screen that protects the roof washer from the intrusion of waste and vermin.
- The roof washer shall rely on manually operated valves or other devices to do the diversion.

### **Storage Tank or Cistern**

The cistern is the most expensive component of the collection system. Cisterns are commonly constructed of fiberglass, polyethylene, concrete, metal, or wood. Larger tanks for potable use are available in either fiberglass for burial or corrugated, galvanized steel with polyvinyl chloride (PVC) or polyethylene liners for aboveground installations. Tanks can be installed aboveground (either adjacent to or remote from a structure), under a deck, or in the basement or crawl space.

Aboveground installations are less expensive than belowground applications, all other factors being equal. Aesthetic preferences or space limitations may dictate that the tank be located belowground, or away from the structure.

Multiple tank systems provide redundancy, allowing the system to continue to operate if one of the tanks needs to be shut down for maintenance.

The following criteria apply to storage tanks and cisterns for rainwater harvesting:

- All cisterns shall be listed for use with potable water and shall be capable of being filled from both the rainwater harvesting system and the public or private water system.
- The municipal or on-site well water system shall be protected from cross-contamination in accordance with local jurisdiction requirements.
- Backflow assemblies shall be maintained and tested in accordance with local jurisdiction requirements.
- Cisterns shall have access to allow inspection and cleaning.
- For above grade cisterns, the ratio of the cistern size shall not be > 1:1 height to width. An engineered tank with an engineered foundation may have a height that exceeds the width (subject to approval of the authority having jurisdiction). The ratio for below grade cisterns is not limited.
- Below-grade cisterns shall be provided with manhole risers a minimum of 8 inches above surrounding grade and shall have tie-downs per manufacturer's specifications, or the

excavated site must have a daylight drain or some other drainage mechanism to prevent floating of the cistern resulting from elevated ground water levels.

- Cisterns shall be protected from sunlight to inhibit algae growth and ensure life expectancy of tank.
- All cistern openings shall be protected from unintentional entry by humans or vermin. Manhole covers shall be provided and shall be secured to prevent tampering. Where an opening is provided that could allow the entry of personnel, the opening shall be marked, “DANGER – CONFINED SPACE.”
- Cistern outlets shall be located  $\geq 4$  inches above the bottom of the cistern.
- The cistern shall be equipped with an overflow device. The overflow device shall consist of a pipe equal to or greater than the cistern inlet and a minimum of 4 inches below any makeup device from other sources. The overflow outlet shall be protected with a screen having openings  $\leq 0.25$  inches or a self-sealing cover.

### **Pumps and Pressure Tanks**

Adequate elevation to deliver water from the storage tank to the filtration and disinfection system and the house at adequate pressure is often not available. Standard residential water pressure is 40 to 60 pounds per square inch (psi). Two methods are used to attain proper pressure: (1) a pump with a pressure tank, pressure switch, and check valve; or (2) an on-demand pump. The first system uses the pressure tank to keep the system pressurized and the pressure switch initiates the pump when pressure falls below a predetermined level. The check valve prevents pressurized water from returning to the tank. The on-demand pump is self-priming and incorporates the pressure switch, pressure tank, and check valve functions in one unit ([Texas Water Development Board, 2005](#)).

Where a pump is provided in conjunction with the rainwater harvesting system, the pump shall meet the following criteria:

- The pump and all other pump components shall be listed and approved for use with potable water systems.
- The pump shall be capable of delivering a minimum of 15 psi residual pressure at the highest outlet served. Minimum pump pressure shall allow for friction and other pressure losses. Maximum pressures shall not exceed 80 psi.

### **Back Flow Prevention**

Rainwater is most commonly used to augment an existing potable supply for uses that do not require treatment to be potable. Typically, such systems augment an existing supply because the cistern will likely run dry or near dry in the summer. See local jurisdiction requirements for preventing backflow and subsequent contamination of the potable water supply.

### **Harvested Rainwater Treatment**

Harvested rainwater treatment falls into three broad categories: filtration, disinfection, and buffering.

## Filtration

Filters remove leaves, sediment, and other suspended particles and are placed between the catchment and the tank or in the tank. Filtering begins with screening gutters to exclude leaves and other debris, routing the first flush through first flush diverters, roof washers, and cistern float filters. Cistern float filters are placed in the storage tank and provide filtration as water is pumped from the tank to the disinfection system and the house. The filter is positioned to float 10 to 16 inches below the water surface where the water is cleaner than the bottom or surface of the water column ([Texas Water Development Board, 2005](#)).

Types of filters for removing the smaller remaining particles include single cartridges (similar to swimming pool filters) and multicartridge filters. These are typically 5-micron filters and provide final mechanism for removing fine particles before disinfection. Reverse osmosis and nanofiltration are filtration methods that require forcing water through a semipermeable membrane. Membranes provide disinfection by removing/filtering very small particles (molecules) and harmful pathogens. Some water is lost in reverse osmosis and nanofiltration with concentrated contaminants. The amount of water lost is proportional to the purity of the feed water ([Texas Water Development Board, 2005](#)).

## Disinfection

- Ultraviolet (UV) radiation uses short wave UV light to destroy bacteria, viruses, and other microorganisms. UV disinfection requires prefiltering of fine particles where bacteria and viruses can lodge and elude the UV light. This disinfection strategy should be equipped with a light sensor and a readily visible alert to detect adequate levels of UV light ([Texas Water Development Board, 1997](#)).
- Ozone is a form of oxygen produced by passing air through a strong electrical field. Ozone kills microorganisms and oxidizes organic material to carbon dioxide (CO<sub>2</sub>) and water. The remaining ozone reverts back to dissolved oxygen ([Texas Water Development Board, 1997](#)). Care must be exercised in the choice of materials used in the system using this disinfection technique due to ozone's aggressive properties.
- Activated carbon removes chlorine and heavy metals, objectionable tastes, and most odors.
- Chlorine (commonly in the form of sodium hypochlorite) is a readily available and dependable disinfection technique. Household bleach can be applied in the cistern or feed pumps that release small amounts of solution while the water is pumped ([Texas Water Development Board, 1997](#)). There are two significant limitations of this technique: chlorine leaves an objectionable taste (this can be removed with activated charcoal); and prolonged presence of chlorine with organic matter can produce chlorinated organic compounds (e.g., trihalo-methanes) that can present health risks ([Texas Water Development Board, 1997](#)).
- For potable water systems, the water must be filtered and disinfected after it exits the storage reservoir and immediately before the point of use (Texas Water Development Board, 2005).

## Buffering

As stated previously, rainwater is usually slightly acidic (a pH of approximately 5.6 is typical). Total dissolved salts and minerals are low in precipitation, and buffering with small amounts of a common buffer, such as baking soda, can adjust collected rainwater to near neutral ([Texas Water Development Board, 1997](#)). Buffering should be done each fall after tanks have first filled.

## **Design Procedure**

The basic rule for sizing any rainwater harvesting system is that the volume of water that can be captured and stored (the supply) must equal or exceed the volume of water used (the demand) ([Texas Water Development Board, 2005](#)). Understanding the water balance will allow the designer to understand whether harvested rainwater will be adequate to meet demands. Stormwater runoff from roof areas only should be directed to rainwater harvesting systems.

The size of the roof, expressed as the catchment area, is equal to the width times the length of the area flowing to a gutter. The slope of the roof is not considered in the catchment area calculation (e.g., the horizontal projection of the area is used for sizing, which is smaller than the actual area for sloped roofs).

General guidelines for sizing the rainwater collection system to the catchment area include the following:

- Rainfall of 1 inch on 1 sf of rooftop will produce 0.6233 gallons of water or approximately 600 gallons per 1,000 sf of roof without inefficiencies in the collection process.
- The system will lose approximately 10 to 25% of the total rainfall due to evaporation, initial wetting of the collection material, and inefficiencies in the collection process ([Texas Water Development Board, 2005](#)). Precipitation loss increases with the roughness of the roofing material. Precipitation loss is the least with metal, more with composition, and greatest with wood shake or shingle.

See the *Texas Manual on Rainwater Harvesting* ([Texas Water Development Board, 2005](#)) for a detailed discussion on water balance modeling for sizing of rainwater harvesting systems. Where daily or sub-daily rainfall data are available, daily or sub-daily water balance modeling is recommended over monthly water balance modeling. The finer time scale will allow the designer to evaluate the timing and magnitude of system overflows, thereby allowing for more accurate sizing of downstream conveyance and flow control BMPs where needed.

If the water balance model used to size the rainwater harvesting system shows that there is no overflow (e.g., all of the stored water is used or evaporated), subtract the contributing roof area from the hydrologic model used to size flow control BMPs to meet [2.7.7 Core Element #6: Flow Control](#).

### **Estimating Indoor Water Demand**

Indoor water demand is largely unaffected by changes in weather, although changes in household occupancy rates depending on the season and very minor changes in consumption of water due to increases in temperature may be worth considering in some instances. The results of a study of 1,200 single-family homes indicated that the average water-conserving household used approximately 49.6 gallons per person per day ([AWWA, 1999](#)). Many households use less than this average. Overall demand for showers, baths, and faucet uses is a function of both time of use and rate of flow. Many people do not open the flow rate as high as it could be, finding low or moderate flow rates more comfortable ([WSU - PSP, 2012](#)). In estimating demand, measuring flow rates and consumption in the household may be worth the effort to get more accurate estimates but should be verified with the records of historical use from a municipal water bill if available.

### **Estimating Outdoor Water Demand**

Outdoor water demand peaks during the summer months. The water demands of a large turf grass area often exceed the volume of harvested rainwater for irrigation. For planning purposes, historical evapotranspiration and evaporation should be used to project potential water demand. Additional resources related to the water demands for standard and drought tolerant landscapes by region are available.

### **Screening Criteria**

Assessing the feasibility of using a rainwater harvesting system should include both technical and economic considerations. Rainwater harvesting systems are technically feasible for most sites where applicable local setback requirements for structures can be met. In areas with little rainfall, the systems will supplement, rather than replace, other domestic sources of water. Rainwater collection systems may make a project situated in a challenging drainage basin more easily developable because stormwater from roof surfaces can be collected and used for a variety of nonpotable uses.

From a technical design perspective, rainwater harvesting systems should not be used to collect stormwater from roof materials containing contaminants such as zinc, copper, or lead. Depending on the BMPs connected, a rainwater harvesting system could spread these contaminants throughout a site through the irrigation system or bring the contaminants into contact with humans through nonpotable water reuse.

In very rare instances, there may be entitlement challenges associated with constructing a rainwater harvesting system. A rainwater harvesting system would require a water right only if > 5,000 gallons are to be collected daily.

### ***Construction Criteria***

The technology for rainwater harvesting is well developed and the components are commercially available. Placing a cistern underground may result in a considerable amount of excavation and grading. Where rainwater harvesting systems are used for nonpotable uses, the sophistication of the design will benefit from an experienced contractor. Contractors should confirm the occurrence of the following:

- A cistern should be located where the surrounding area can be graded to provide good drainage of stormwater runoff away from the cistern. Avoid placing cisterns in low areas subject to flooding. This will reduce the chance of untreated storm runoff contaminating the stored cistern water.
- Cisterns should always be located upslope from any sewage disposal facilities.
- Underground cisterns should be provided with manhole risers extending a minimum of 8 inches above surrounding grade and should have tie-downs per manufacturer's specifications. If tie-down systems are not provided, the excavated site should have a daylight drain or some other drainage mechanism to prevent floating of the cistern resulting from elevated ground water levels.
- Manhole openings should have a watertight curb with edges projecting several inches above the level of the surrounding surface. The edges of the manhole cover should overlap the curb and project downward a minimum of 2 inches. Manhole covers should be provided with locks to further reduce the danger of contamination and accidents.



- Place the manhole opening near a corner or an edge of the structure so that a ladder can be lowered into the cistern and braced securely against a wall.
- All cistern openings should be protected from unintentional entry by humans or vermin. Manhole covers should be provided and secured to prevent tampering. Where an opening is provided that could allow the entry of personnel, the opening shall be marked “DANGER – CONFINED SPACE.”
- Cisterns should be protected from sunlight to inhibit algae growth to ensure the life expectancy of the tank.
- The floor of the cistern should be constructed to slope slightly toward the drain to facilitate cleaning. The valve and drain line should be insulated by a sufficient depth of earth to prevent freezing during even the most severe winter weather.
- Cisterns should be vented to allow fresh air to circulate into the storage compartment. The openings, located several feet above ground level, should be oriented to face the direction of the prevailing winds, west in most cases, to maximize ventilation. For the vents, 4- or 6-inch-diameter plastic pipe is adequate. The contractor should confirm that each vent pipe has a watertight seal through the top of the cistern.
- Cisterns should be located as close as possible to the structure benefitting from the water reuse or landscape planned for irrigation.
- Cisterns should be installed in accordance with the manufacturer’s installation instructions. Where the installation requires a foundation, the foundation shall be flat and be capable of supporting the cistern weight when the cistern is full.

### ***Operation and Maintenance Criteria***

- Maintenance criteria for rainwater collection systems include typical household and system specific procedures. All controls, overflows, and clean-outs should be readily accessible and alerts for system problems should be easily visible and audible.
- Debris should be removed from the roof as it accumulates.
- Gutters should be cleaned as necessary (for example in September, November, January, and April. The most critical cleaning is in mid- to late-spring to flush pollen deposits from surrounding trees.
- Screens at the top of the downspout should be maintained in good condition.
- Prefilters should be cleaned monthly.
- Filters should be changed every 6 months or as a drop in pressure is noticed.
- Storage tanks should be chlorinated quarterly at 0.2 to 0.5 parts per million (ppm) or a rate of 0.25 cup of household bleach (5.25% solution) to 1,000 gallons of stored water.
- Storage tanks should be inspected and debris removed periodically as needed.
- When storage tanks are cleaned, the inside surface should be rinsed with a chlorine solution of 1 cup bleach to 10 gallons water.

- Roof washers should be readily accessible for regular maintenance.
- Prefiltration screens or filters should be maintained consistent with manufacturer’s specifications.

**For more information:** See [Appendix 6-A: Recommended Maintenance Criteria for Flow Control BMPs](#) for additional recommendations for maintenance of rainwater harvesting systems.

## 6.2.6 Control Structures

Control structures are catch basins or maintenance holes with a restrictor device for controlling outflow from a BMP to meet the desired performance. Riser-type restrictor devices (“tees”) or flow restrictor oil pollution control tees (“FROP-Ts”) also provide some incidental oil and water separation to temporarily detain oil or other floatable pollutants in runoff due to accidental spill or illegal dumping.

The restrictor device usually consists of two or more orifices and/or a weir section sized to meet performance requirements.

Standard control structure details are shown in [Figure 6.10: Flow Restrictor \(Tee\)](#) and [Figure 6.11: Flow Restrictor \(Weir\)](#).

### General Criteria

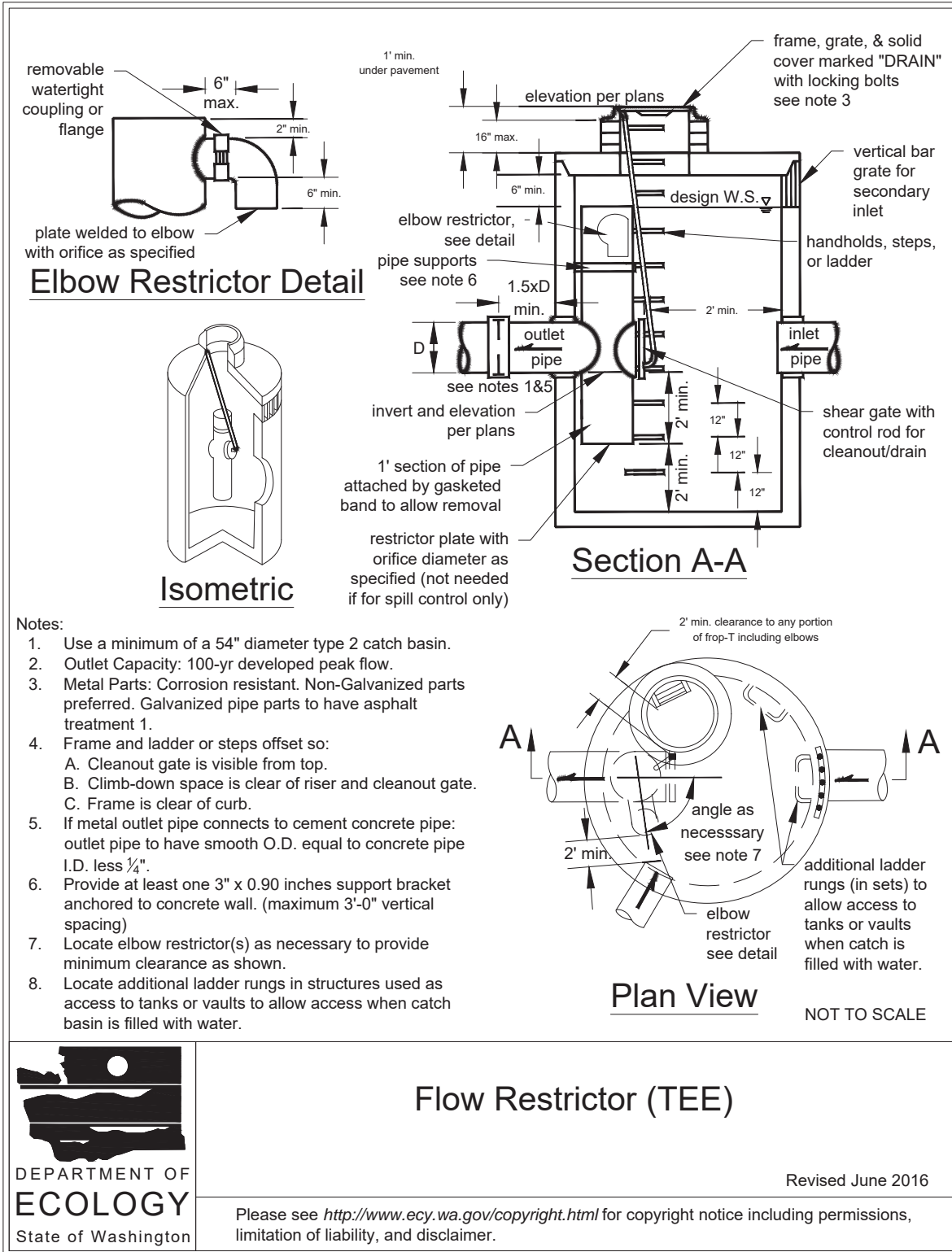
#### Multiple Orifice Restrictor

In most cases, control structures need only two orifices: one at the bottom and one near the top of the riser, although additional orifices may best use detention storage volume. Several orifices may be located at the same elevation if necessary to meet performance requirements.

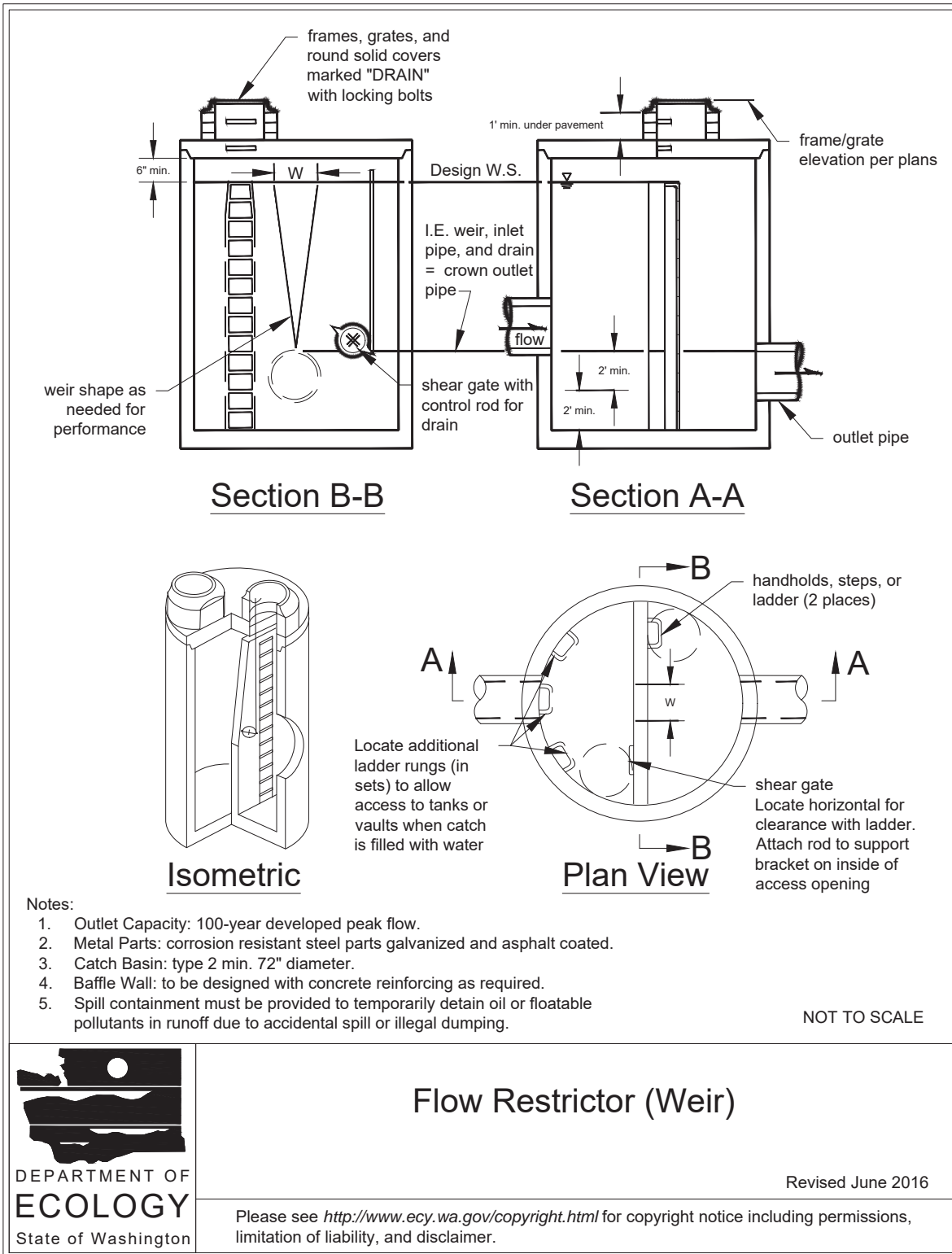
The following criteria apply to the design of multiple orifice restrictors:

- Minimum orifice diameter is 1.0 inch, subject to confirmation by the local jurisdiction.
- Orifices may be constructed on a tee section as shown in [Figure 6.10: Flow Restrictor \(Tee\)](#) or on a baffle as shown in [Figure 6.11: Flow Restrictor \(Weir\)](#).
- In some cases, performance requirements may require the top orifice/elbow to be located too high on the riser to be physically constructed (e.g., a 13-inch-diameter orifice positioned 0.5 feet from the top of the riser). In these cases, a notch weir in the riser pipe may be used to meet performance requirements (see [V-Notch Sharp-Crested Weir](#)).
- Consideration must be given to the backwater effect of water surface elevations in the downstream conveyance system. High tailwater elevations may affect performance of the restrictor system and reduce live storage volumes.

**Figure 6.10: Flow Restrictor (Tee)**



**Figure 6.11: Flow Restrictor (Weir)**



## **Riser and Weir Restrictor**

- Properly designed weirs may be used as flow restrictors (see [Figure 6.10: Flow Restrictor \(Tee\)](#) and [Figure 6.11: Flow Restrictor \(Weir\)](#)). However, they must be designed to provide for primary overflow of the developed 25-year peak flow discharging to the detention BMP.
- The combined orifice and riser (or weir) overflow may be used to meet performance requirements; however, the design must still provide for primary overflow of the developed 25-year peak flow assuming all orifices are plugged. See [Riser Overflow](#) for a description of how to calculate the head in feet above a riser of given diameter and flow.

## **Access**

The following guidelines for access may be used:

- An access road to the control structure is needed for inspection and maintenance, and must be designed and constructed as specified for detention ponds (see [6.2 Detention BMPs](#)).
- Manhole and catch basin lids for control structures must be locking, and rim elevations must match proposed finish grade.
- Maintenance holes and catch basins must meet the Occupational Safety and Health Administration (OSHA) and Washington Industrial Safety and Health Act (WISHA) confined space requirements, which include clearly marking entrances to confined space areas. This may be accomplished by hanging a removable sign in the access riser, just under the access lid.

## **Information Plate**

It is recommended that a brass or stainless steel plate be permanently attached inside each control structure with the following information engraved on the plate:

- Name and file number of project
- Name and company of (1) developer, (2) designer, and (3) contractor
- Date constructed
- Date of manual used for design
- Outflow performance criteria
- Release mechanism size, type, and invert elevation
- List of stage, discharge, and volume at 1-foot increments
- Elevation of overflow
- Recommended frequency of maintenance

## Design Procedure

This section presents the methods and equations for design of control structure restrictor devices. Included are details for the design of orifices, rectangular sharp-crested weirs, v-notch weirs, suture weirs, and overflow risers.

### Orifices

Flow-through orifice plates in the standard tee section or turn-down elbow may be approximated by the general equation:

#### **Equation 6.4: Flow-Through Orifice Plate Flow**

$$Q = C * A * (2 * g * h)^{1/2}$$

where:

Q = flow (cfs)

C = coefficient of discharge (0.62 for plate orifice)

A = area of orifice (sf)

h = hydraulic head (ft)

g = gravity (32.2 ft/sec<sup>2</sup>)

[Figure 6.12: Simple Orifice](#) illustrates this simplified application of the orifice equation.

The diameter of the orifice is calculated from the flow. The orifice equation is often useful when expressed as the orifice diameter in inches:

#### **Equation 6.5: Orifice Diameter**

$$d = \sqrt{\frac{36.88 * Q}{\sqrt{h}}}$$

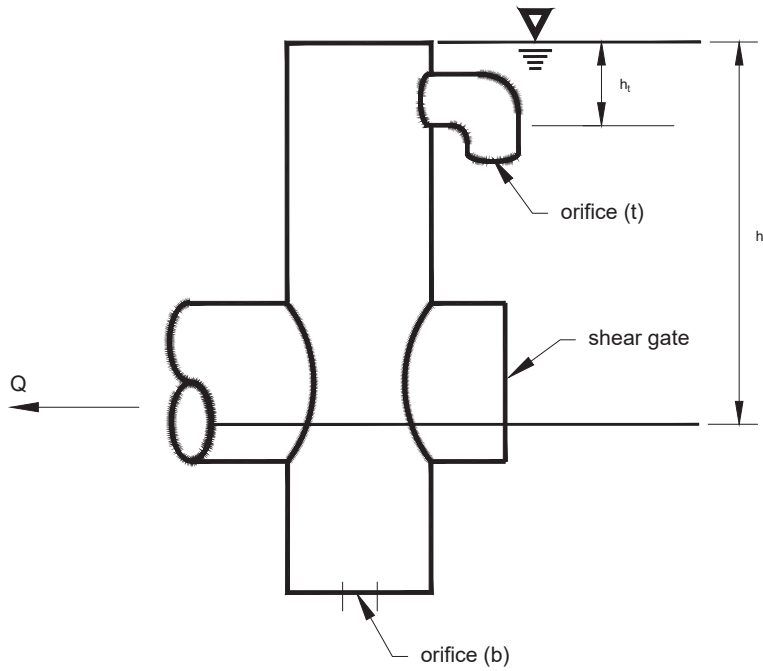
where:

d = orifice diameter (inches)

Q = flow (cfs)

h = hydraulic head (ft)

**Figure 6.12: Simple Orifice**



$$Q = CA_b \sqrt{2gh_b} + CA_t \sqrt{2gh_t}$$

$$= C \sqrt{2g} (A_b \sqrt{h_b} + A_t \sqrt{h_t})$$

$h_b$  = distance from hydraulic grade line at the 2-year flow of the outflow pipe to the overflow elevation

NOT TO SCALE



## Simple Orifice

Revised June 2016

Please see <http://www.ecy.wa.gov/copyright.html> for copyright notice including permissions, limitation of liability, and disclaimer.

## **Rectangular Sharp-Crested Weir**

The rectangular sharp-crested weir design shown in [Figure 6.13: Rectangular, Sharp Crested Weir](#) may be analyzed using standard weir equations for the fully contracted condition.

### **Equation 6.6: Rectangular Sharp-Crested Weir Flow**

$$Q = C * [L - (0.2 * H)] * H^{3/2}$$

where:

Q = flow (cfs)

C = constant (ft) =  $3.27 + 0.40 * H/P$

H = head (ft) as shown on Figure 6.2.13

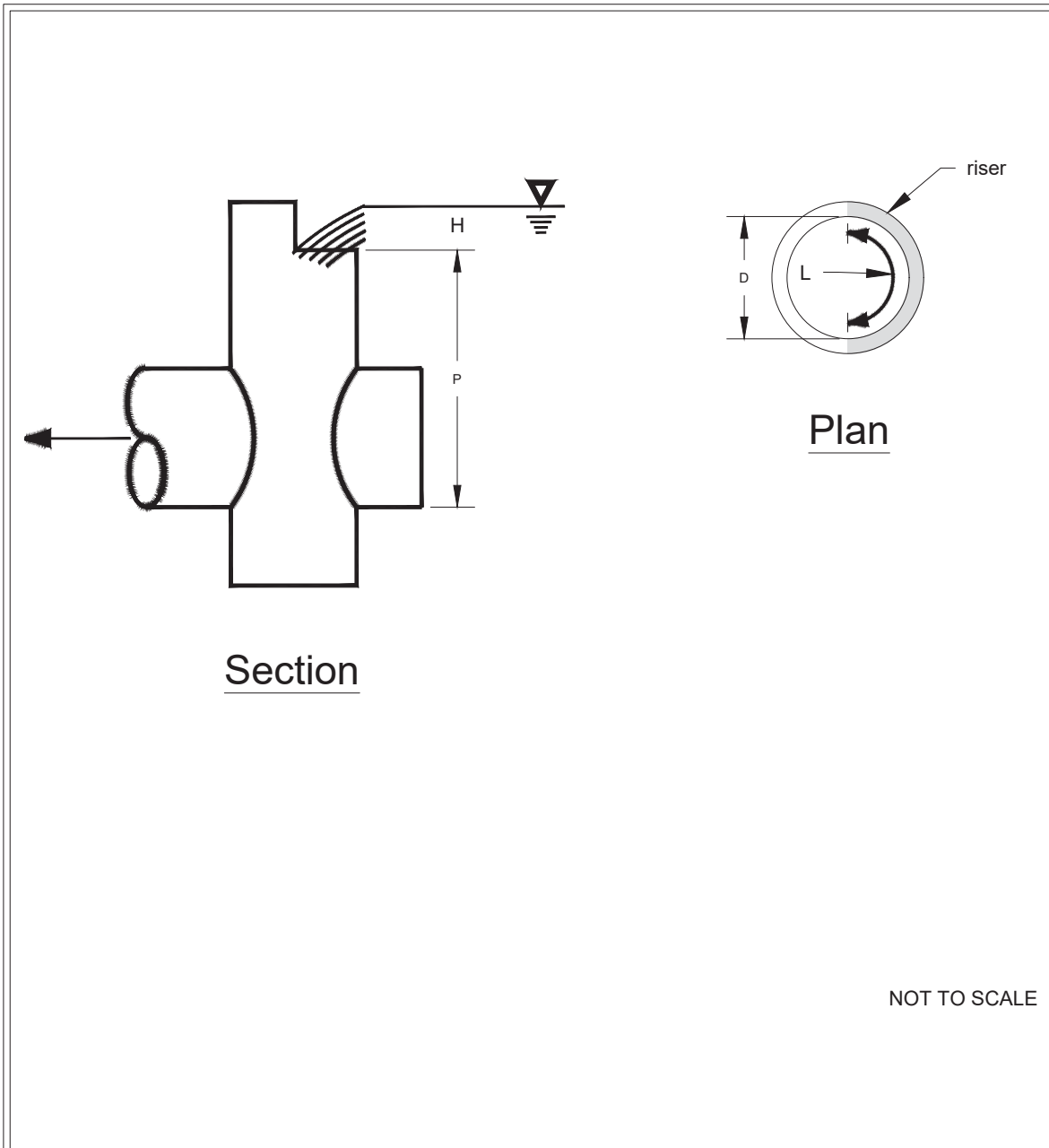
P = height above pipe invert (ft) as shown on [Figure 6.13: Rectangular, Sharp Crested Weir](#)

L = length (ft) of the portion of the riser circumference as necessary, not to exceed 50% of the circumference

**Note:** [Equation 6.6: Rectangular Sharp-Crested Weir Flow](#) accounts for side contractions by subtracting 0.1H from L for each side of the notch weir.



**Figure 6.13: Rectangular, Sharp Crested Weir**



NOT TO SCALE



## Rectangular, Sharp-Crested Weir

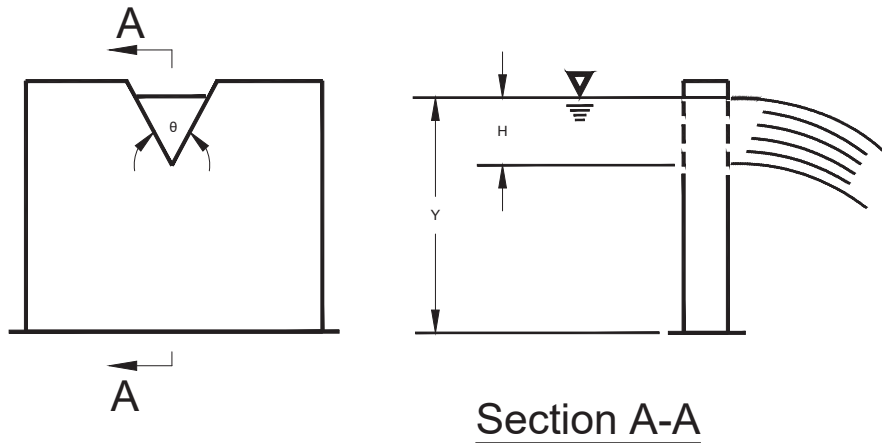
Revised June 2016

Please see <http://www.ecy.wa.gov/copyright.html> for copyright notice including permissions, limitation of liability, and disclaimer.

### **V-Notch Sharp-Crested Weir**

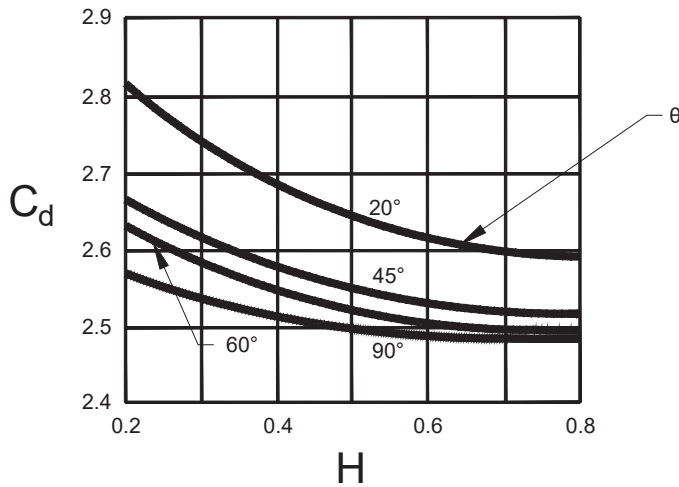
V-notch weirs may be analyzed using the standard equations provided on [Figure 6.14: V-Notch, Sharp-Crested Weir](#).

**Figure 6.14: V-Notch, Sharp-Crested Weir**



$$Q = C_d \left( \tan \frac{\theta}{2} \right) H^{\frac{5}{2}} \text{ in cfs}$$

Where values of  $C_d$  may be taken from the following chart :



NOT TO SCALE



## V-Notch, Sharp-Crested Weir

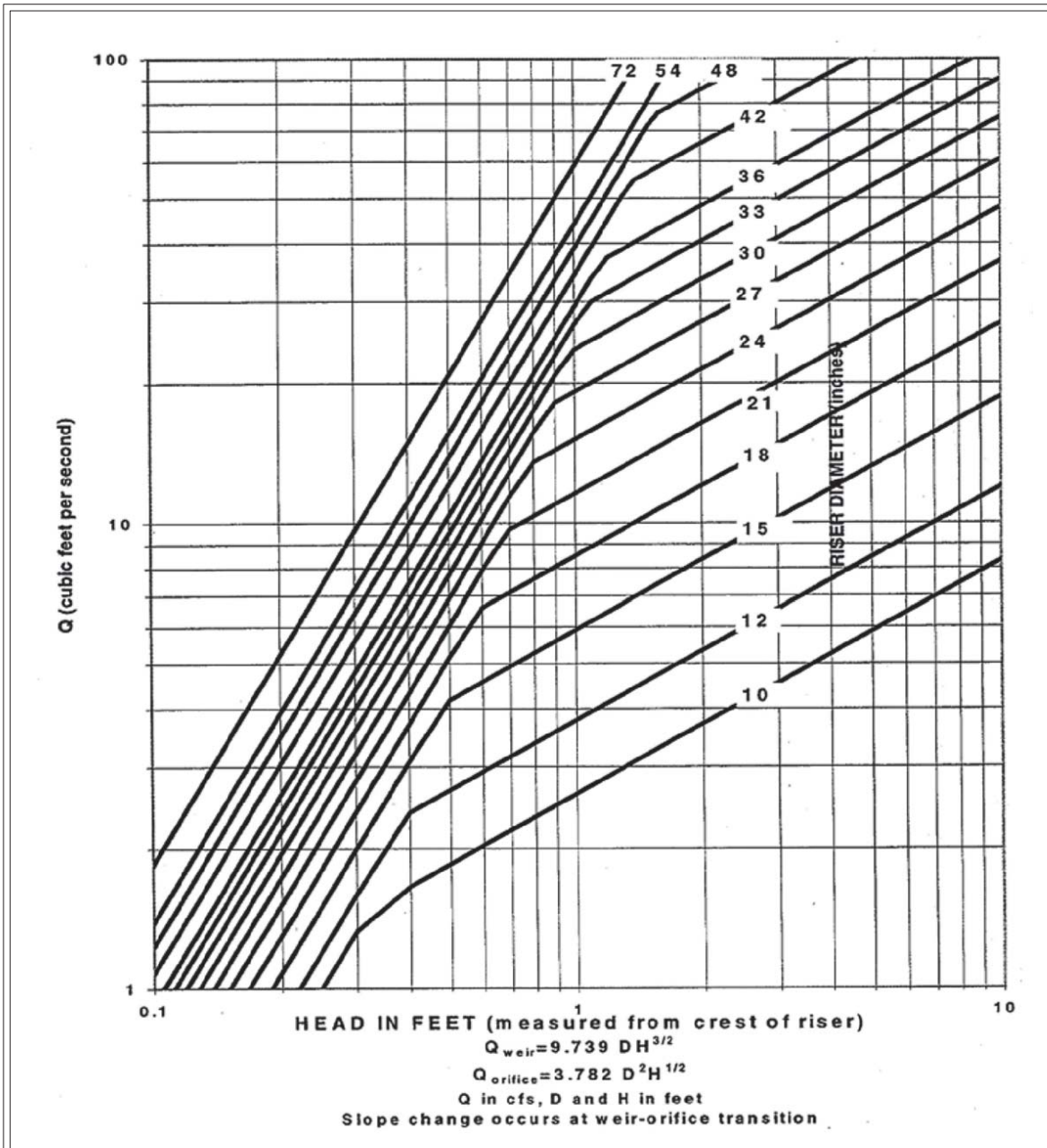
Revised June 2016

Please see <http://www.ecy.wa.gov/copyright.html> for copyright notice including permissions, limitation of liability, and disclaimer.

## **Riser Overflow**

The nomograph in [Figure 6.15: Riser Inflow Curves](#) can be used to determine the head (in feet) above a riser of given diameter and for a given flow (usually the 25- to 100-year peak flow for developed conditions).

**Figure 6.15: Riser Inflow Curves**



## Riser Inflow Curves

Revised June 2016

Please see <http://www.ecy.wa.gov/copyright.html> for copyright notice including permissions, limitation of liability, and disclaimer.

## ***Operation and Maintenance Criteria***

Control structures and catch basins have a history of maintenance-related problems and it is imperative that a good maintenance program be established for their proper functioning. A typical problem is that sediment builds up inside the structure which blocks or restricts flow to the inlet. Similarly, ice buildup during the winter may also block or restrict flows.

To prevent this problem, these structures should be routinely cleaned out. Regular inspections of control structures should be conducted to detect the need for nonroutine cleaning, especially if construction or land-disturbing activities are occurring in the contributing area.

A 15-foot-wide access road to the control structure should be installed for inspection and maintenance.

**Note:** [Appendix 6-A: Recommended Maintenance Criteria for Flow Control BMPs](#) provides maintenance recommendations for control structures and catch basins.

## **6.2.7 Supplemental Guidelines for Detention**

### ***Use of Parking Lots for Additional Detention***

Parking lots may be used to provide additional detention volume for runoff events greater than the design storm, provided that all the following criteria are met:

- The depth of water detained does not exceed 1 foot (or other depth established by the permitting authority or local jurisdiction) at any location in the parking lot for runoff events up to and including the 100-year design flow.
- The gradient of the parking lot area subject to ponding is 1% or greater.
- The emergency overflow path is identified and noted on the engineering plan. The overflow must not create a significant adverse impact on downhill properties or drainage system.
- Fire lanes used for emergency equipment are free of ponding water for all runoff events up to and including the 100-year design flow.
- A downstream runoff treatment BMP with sorptive oil removal is needed prior to discharge to surface or ground water.

## **6.3 Infiltration BMPs**

### **6.3.1 Purpose**

An infiltration BMP is typically an open basin (pond), trench, or buried perforated pipe used for distributing the stormwater runoff into the underlying soil. Stormwater drywells receiving uncontaminated or properly treated stormwater can also be considered as infiltration BMPs. (See Underground Injection Control Program, [Chapter 173-218 WAC](#) and [5.6 Subsurface Infiltration \(Underground Injection Control Wells\)](#) in the *Stormwater Management Manual for Eastern Washington* (manual).

Coarser, more permeable soils can be used for flow control if the stormwater discharge does not cause a violation of ground water quality criteria. Treatment for removal of TSS, oil, and/or soluble pollutants may be necessary prior to conveyance to an infiltration BMP. Companion practices, such as street sweeping, catch basin inserts, and similar BMPs, can provide additional benefit and reduce the cleaning and maintenance needs for the infiltration BMP. The hydraulic design goal should be to mimic the natural hydrologic balance between surface and ground water.

### ***BMPs in this Section***

Five infiltration BMPs are described in this section:

- [BMP F6.20: Drywells](#)
- [BMP F6.21: Infiltration Ponds](#)
- [BMP F6.22: Infiltration Trenches](#)
- [BMP F6.23: Bioretention](#)
- [BMP F6.24: Permeable Pavement](#)

### **6.3.2 Application**

Infiltration BMPs are used to convey stormwater runoff from new development or redevelopment to the ground and ground water after appropriate treatment. Runoff in excess of the infiltration capacity must be detained and released in compliance with the flow control requirements of the local jurisdiction.

Infiltration BMPs may be used for flow control where runoff treatment is not required or for flows greater than the water quality design storm, or where runoff is treated prior to discharge. See [5.6 Subsurface Infiltration \(Underground Injection Control Wells\)](#) to classify the vadose zone treatment capacity and determine treatment requirements for underground injection control (UIC) wells.

[Table 6.2: Applicability of Infiltration BMPs for Runoff Treatment, Flow Control, and Conveyance](#) summarizes the applicability of infiltration BMPs for runoff treatment, flow control, and conveyance.

**Table 6.2: Applicability of Infiltration BMPs for Runoff Treatment, Flow Control, and Conveyance**

BMP	Runoff Treatment					Flow Control	Conveyance
	Pretreatment	Basic	Metals	Oil Control	Phosphorus		
<a href="#">BMP F6.20: Drywells</a>						✓	
<a href="#">BMP F6.21: Infiltration Ponds</a>	✓ <sup>a</sup>	✓ <sup>a</sup>	✓ <sup>a</sup>			✓	
<a href="#">BMP F6.22: Infiltration Trenches</a>	✓ <sup>b</sup>	✓ <sup>b</sup>	✓ <sup>b</sup>			✓	
<a href="#">BMP F6.23: Bioretention</a>	✓ <sup>c</sup>	✓ <sup>c</sup>	✓ <sup>c</sup>	✓ <sup>c</sup>		✓	✓
<a href="#">BMP F6.24: Permeable Pavement</a>		✓ <sup>d</sup>	✓ <sup>d</sup>			✓	✓
<sup>a</sup> See <a href="#">BMP T5.10: Infiltration Ponds</a> . <sup>b</sup> See <a href="#">BMP T5.20: Infiltration Trenches</a> . <sup>c</sup> See <a href="#">BMP T5.31: Bioretention</a> . <sup>d</sup> See Water Quality Treatment section for <a href="#">BMP F6.24: Permeable Pavement</a> for details on the Site Suitability Criteria or treatment layer needed to count for runoff treatment credit.							

The discharge of uncontaminated or properly treated stormwater to drywells must comply with Ecology’s UIC regulations ([Chapter 173-218 WAC](#)); see [5.6 Subsurface Infiltration \(Underground Injection Control Wells\)](#).

Benefits of infiltration include the following:

- Ground water recharge.
- Retrofits in limited land areas: Infiltration trenches can be considered for residential lots, commercial areas, parking lots, and open space areas.
- Flood control.
- Streambank erosion control.

### 6.3.3 General Criteria for Infiltration BMPs

This section covers general design criteria including Site Suitability Criteria (SSC), determination of infiltration rates, BMP sizing, construction criteria, and operation and maintenance (O&M) criteria



that apply to all subsurface infiltration BMPs such as drywells, infiltration basins, and infiltration trenches.

### **Site Suitability Criteria**

Not all sites are suitable for infiltration BMPs. See the Site Suitability Criteria subsection in [5.4.3 General Criteria for Infiltration and Bioinfiltration BMPs](#) when evaluating a site for the feasibility of infiltration-based stormwater disposal.

### **Determination of Infiltration Rates**

Many qualitative and quantitative procedures have been developed to estimate the infiltration rates of soils, including those created by American Society for Testing and Materials (ASTM) International, the Soil Conservation Service (SCS), American Association of State Highway and Transportation Officials (AASHTO), and the U.S. Bureau of Reclamation. If allowed by the local jurisdiction (see [2.7.9 Core Element #8: Local Requirements](#)), the presumptive infiltration rates provided in [Table 5.10: Infiltration Rates for Surface Infiltration and Bioinfiltration BMPs](#) may be used. Note, however, that correct determination of the design infiltration rate is key to the short- and long-term performance of infiltration BMPs. Infiltration BMPs may fail and cause flooding if incorrect infiltration rates are used in design.

The following sections discuss approved field and laboratory infiltration testing methods and correction factors that may be applied to the short-term (initial) measured saturated hydraulic conductivity to determine the long-term design infiltration rate of the subgrade soil profile.

### **Field and Laboratory Infiltration Testing Methods**

A brief description of approved field and laboratory infiltration testing methods, advantages and disadvantages of each method, and applicability are summarized in [Table 6.3: Infiltration Testing and Evaluation Methods](#). Guidance for conducting geotechnical studies that support infiltration rate determination, including recommended field and laboratory test procedures, is included in Appendix 6B.

The field and laboratory testing methods summarized in [Table 6.3: Infiltration Testing and Evaluation Methods](#) may be used to determine the short-term (initial) saturated hydraulic conductivity for subgrade (existing) soil profile beneath an infiltration BMP. The initial or measured saturated hydraulic conductivity with no correction factor may be used as the design infiltration rate if the licensed professional deems the infiltration testing described below (and perhaps additional tests) is conducted in locations and at adequate frequencies that produces a soil profile characterization that fully represents the infiltration capability where bioretention areas are located (e.g., if small-scale pilot infiltration tests [PITs] are performed for all infiltration BMPs and the site soils are adequately homogeneous). Where multiple tests are completed, the lowest infiltration rate determined from each soil unit should be used as the representative site infiltration rate.

The saturated hydraulic conductivity test method appropriate for a site will depend on subsurface conditions, the scale of the infiltration BMP in relation to the test, and other factors. Depending on applicability, the initial  $K_{sat}$  can be determined using one or both of the following:

- A field test method summarized in [Table 6.3: Infiltration Testing and Evaluation Methods](#) and/or [6.B.3 Recommended Field Test Procedures](#)

- A laboratory test method summarized in [Table 6.3: Infiltration Testing and Evaluation Methods](#) and/or [6.B.4 Recommended Laboratory Test Procedures](#)

See the following section ([Correction Factors for Subgrade Soils Underlying Infiltration BMPs](#)) for guidelines on determining when correction factors are needed and how they should be applied to estimate the long-term design infiltration rate based on measured (short-term) saturated hydraulic conductivity.

**Table 6.3: Infiltration Testing and Evaluation Methods**

<p><b>Borehole percolation test (e.g., California Test 750; U.S. EPA, 1980):</b> Field test method originally developed for sizing septic systems that involves installation of a small-diameter (e.g., 6-inch) borehole and casing (e.g., slotted pipe or well screen), filling with clean water, and collecting measurements during a constant-head and drawdown period.</p>		
<p><b>Advantages</b></p> <ul style="list-style-type: none"> <li>• Short-duration test (minimum of 1 hour, maximum of 1.5 hours)</li> <li>• Low cost and relatively easy to implement</li> <li>• Multiple tests can be performed at the same time</li> <li>• Preliminary assessment when performed in conjunction with grain-size distribution correlations</li> <li>• Can test material at depth without excavating</li> </ul>	<p><b>Disadvantages</b></p> <ul style="list-style-type: none"> <li>• Saturates a small amount of soil at the test location (i.e., small in scale)</li> <li>• May require multiple borings in areas with variable soils</li> <li>• Measures short-term infiltration rate; correction factors need to be applied for long-term (design) infiltration rates</li> <li>• Does not work well for areas with interbedded fine-grained sediments and/or changes in hydraulic conductivity below the tested area</li> <li>• May underestimate infiltration rate when drilling process creates borehole skin effect (i.e., smearing of sidewalls)</li> </ul>	<p><b>Applicability</b></p> <p>Infiltration BMP design</p>
<p><b>Large-scale pilot infiltration test (PIT):</b> Field test method involving an excavated test pit with a bottom surface area of approximately 100 square feet (sf). Involves filling with clean water and measuring water level during a constant-head and drawdown period.</p>		
<p><b>Advantages</b></p> <ul style="list-style-type: none"> <li>• Larger-scale test that reduces scale error associated with site heterogeneity</li> <li>• Sufficient infiltration period to promote adequate soil presoaking and a stabilized infiltration rate</li> </ul>	<p><b>Disadvantages</b></p> <ul style="list-style-type: none"> <li>• Requires significantly greater effort, time, and space than small-scale infiltration tests (borehole percolation test or double-ring infiltrometer)</li> <li>• Logistical constraints (e.g., little or no water for testing, depth of the proposed infiltration system, difficult access, etc.)</li> <li>• Difficult to provide a water source to maintain a</li> </ul>	<p><b>Applicability</b></p> <ul style="list-style-type: none"> <li>• Infiltration BMP design</li> <li>• Large-scale permeable pavement installations where the stormwater from adjacent impervious surfaces is directed to the permeable pavement surface (high hydraulic load)</li> </ul>

**Table 6.3: Infiltration Testing and Evaluation Methods (continued)**

	sufficient head in permeable sands and gravels	
<p><b>Small-scale PIT:</b> Field test method involving an excavated test pit with a bottom surface area of approximately 12 to 32 sf. Involves filling with clean water and measuring water level during a constant-head and drawdown period.</p>		
<p><b>Advantages</b></p> <ul style="list-style-type: none"> <li>• Reduces cost and test time compared to the large-scale PIT method</li> <li>• Feasible for sites with high infiltration rates (which makes large-scale PIT method difficult)</li> <li>• Sufficient infiltration period to promote adequate soil presoaking and a stabilized infiltration rate</li> </ul>	<p><b>Disadvantages</b></p> <ul style="list-style-type: none"> <li>• Only applicable to small contributing areas (&lt; 1 acre) or for infiltration BMPs that either serve small contributing areas or are widely dispersed</li> <li>• Requires greater effort, time, and space than small-scale infiltration tests (borehole percolation test or double-ring infiltrometer)</li> <li>• Logistical constraints (e.g., little or no water for testing, depth of the proposed infiltration system, difficult access, etc.)</li> <li>• Difficult to provide a water source to maintain a sufficient head in permeable sand and gravel</li> </ul>	<p><b>Applicability</b></p> <ul style="list-style-type: none"> <li>• Infiltration BMP designs with relatively low hydraulic loadings</li> <li>• Sites with high infiltration rate and uniform subsurface characteristics</li> </ul>
<p><b>Single-ring infiltrometer test:</b> Field test method that involves driving a plastic or metal ring into the soil and measuring water level during a constant-head period.</p>		
<p><b>Advantages</b></p> <ul style="list-style-type: none"> <li>• Small-scale test</li> <li>• Compatible with nonstandard subsurface disposal systems</li> <li>• Can be used to verify that infiltration rates used for design have not been significantly reduced from compaction</li> </ul>	<p><b>Disadvantages</b></p> <ul style="list-style-type: none"> <li>• Increased scale errors compared to other test methods</li> <li>• Measures the rate of infiltration near the soil surface</li> <li>• Impacted by site heterogeneity -results can be highly variable within a site</li> <li>• Poor connection between the ring wall in the soil can cause a leakage of water along the</li> </ul>	<p><b>Applicability</b></p> <ul style="list-style-type: none"> <li>• Bioinfiltration swale design</li> <li>• Detention pond design</li> <li>• Infiltration BMP design</li> </ul>

**Table 6.3: Infiltration Testing and Evaluation Methods (continued)**

	<p>ring wall; may overestimate infiltration rate in these cases</p> <ul style="list-style-type: none"> <li>• Only saturates a small amount of soil at the test location</li> <li>• Does not work well for areas with interbedded fine-grained sediments and/or changes in hydraulic conductivity below the tested area; may overestimate infiltration rate in these cases</li> </ul>	
<p><b>Double-ring infiltrometer test (ASTM D3385-88):</b> Field test method that was originally developed for relatively low hydraulic conductivity infiltration media (pond and landfill liners) that involves two plastic or metal rings and collecting measurements during a constant-head period.</p>		
<p><b>Advantages</b></p> <ul style="list-style-type: none"> <li>• Relatively small-scale test</li> <li>• Apparatus is relatively low cost and easy to assemble</li> <li>• Minimizes the error associated with the single-ring infiltrometer method because the water level in the outer ring forces vertical infiltration of water in the inner ring</li> <li>• Can work well as a preliminary assessment when performed in conjunction with grain-size distribution correlations</li> </ul>	<p><b>Disadvantages</b></p> <ul style="list-style-type: none"> <li>• Poor connection between the ring wall in the soil can cause a leakage of water along the ring wall; may overestimate infiltration rate in these cases</li> <li>• Only saturates a small amount of soil at the test location</li> <li>• Measures the rate of infiltration at the soil surface</li> <li>• Does not provide an accurate measure of saturated vertical hydraulic conductivity</li> <li>• Only measures short-term infiltration rate; correction factors need to be applied for long-term (design) infiltration rates</li> <li>• Does not work well for areas with interbedded fine-grained sediments and/or changes in hydraulic conductivity below</li> </ul>	<p><b>Applicability</b></p> <ul style="list-style-type: none"> <li>• Bioinfiltration swale design</li> <li>• Detention pond design</li> <li>• Infiltration BMP design</li> </ul>

**Table 6.3: Infiltration Testing and Evaluation Methods (continued)**

	the tested area; may overestimate infiltration rate in these cases	
<p><b>U.S. EPA falling-head test:</b> Field test method conducted through pipes of various lengths and diameters placed in pits excavated by a backhoe or through the casing of a hollow-stem auger boring rig.</p>		
<p><b>Advantages</b></p> <p>Tests are easy to conduct</p>	<p><b>Disadvantages</b></p> <p>Significantly varying results depending on the standpipe length and test apparatus configuration</p>	<p><b>Applicability</b></p> <ul style="list-style-type: none"> <li>• Infiltration BMP design</li> <li>• Use in combination with other test methods described above</li> </ul>
<p><b>Soil classification based on laboratory testing (formerly ASTM D2487-90, now ASTM D2487-11):</b> Laboratory test method that classifies soils into categories based on particle size characteristics, the liquid limit, and the plasticity index.</p>		
<p><b>Advantages</b></p> <p>Simple, cost-effective laboratory analysis</p>	<p><b>Disadvantages</b></p> <ul style="list-style-type: none"> <li>• Does not address in-situ soil characteristics, such as density and stratification that affect hydraulic conductivity</li> <li>• Correlation of soil type to infiltration is highly variable based on reference</li> </ul>	<p><b>Applicability</b></p> <p>Initial site suitability for infiltration BMPs</p>
<p><b>Soil grain size analysis method (Massmann, 2008):</b> Laboratory test method that estimates initial saturated hydraulic conductivity using established relationship to grain size.</p>		
<p><b>Advantages</b></p> <ul style="list-style-type: none"> <li>• Used in place of in-situ measurement where allowed</li> <li>• Well-documented correlations between grain size and saturated hydraulic conductivity</li> </ul>	<p><b>Disadvantages</b></p> <ul style="list-style-type: none"> <li>• Does not address in-situ soil characteristics, such as density and stratification, that affect hydraulic conductivity</li> <li>• Empirical equation assumes minimal compaction; must be adjusted if soils are overconsolidated or compacted by glacial advance or due to heavy equipment</li> <li>• Lower precision than in-situ field measurements</li> </ul>	<p><b>Applicability</b></p> <p>Infiltration BMP design for sites with soils unconsolidated by glacial advance</p>

**Table 6.3: Infiltration Testing and Evaluation Methods (continued)**

<p><b>Spokane 200 method (see latest version of the Spokane Regional Stormwater Manual):</b> Laboratory test method that uses “percentage of fines” (i.e., soil gradation data passing the No. 200 sieve) to estimate hydraulic conductivity, initially assess the suitability of on-site soils for subsurface stormwater disposal and correlates percentage of fines with drywell performance</p>		
<p><b>Advantages</b></p> <p>Simple, cost-effective laboratory analysis (No. 200 sieve)</p>	<p><b>Disadvantages</b></p> <ul style="list-style-type: none"> <li>• Developed specifically for the Spokane region and may not apply to other areas of eastern Washington</li> <li>• May also require a full-scale drywell test prior to final project certification to verify design outflow rates</li> <li>• Correlation not developed for infiltration BMPs other than drywells</li> </ul>	<p><b>Applicability</b></p> <p>Determination of outflow rates for drywells (used in the Spokane region or in similar sand/gravel [flood] deposits)</p>
<p><b>Full-scale drywell test:</b> Field test method that involves filling a drywell with clean water and includes a period of constant-head and drawdown measurements.</p>		
<p><b>Advantages</b></p> <p>Postconstruction verification to ensure that a drywell has been designed and constructed properly</p>	<p><b>Disadvantages</b></p> <ul style="list-style-type: none"> <li>• Relatively time consuming (minimum test length of 2.5 hours)</li> <li>• Could require significant flow rate and volume of water depending on outflow capacity of drywell</li> <li>• Can be difficult to correlate performance of an existing drywell to long-term capacity of a new drywell depending on the condition of the drywell</li> </ul>	<p><b>Applicability</b></p> <ul style="list-style-type: none"> <li>• Postconstruction verification of the condition and capacity of a drywell</li> <li>• Site suitability assessment for additional drywell installation</li> </ul>
<p><b>Swale flood test:</b> Field test method that involves filling a swale with clean water until it reaches 6 inches in depth and then timing the drawdown period.</p>		
<p><b>Advantages</b></p> <p>Postconstruction verification to ensure that a swale has been designed and constructed properly</p>	<p><b>Disadvantages</b></p> <ul style="list-style-type: none"> <li>• Must wait until vegetation has been established</li> <li>• Requires a hydrant connection or a water truck</li> </ul>	<p><b>Applicability</b></p> <p>Postconstruction verification of the drawdown time and functionality of a swale (used in the Spokane region)</p>

**Table 6.3: Infiltration Testing and Evaluation Methods (continued)**

	<ul style="list-style-type: none"> <li>• No maximum test length provided</li> <li>• Requires a return visit to verify that the swale has completely drained within 72 hours</li> </ul>	
<p><b>Pond flood test:</b> Field test method that involves filling a pond with clean water until it reaches operational depth (i.e., to the invert elevation of the first outlet device [culvert, orifice, weir, etc.]) and then timing the drawdown period.</p>		
<p><b>Advantages</b></p> <p>Postconstruction verification to ensure that a pond has been designed and constructed properly</p>	<p><b>Disadvantages</b></p> <ul style="list-style-type: none"> <li>• Must wait until vegetation has been established</li> <li>• Requires a hydrant connection or a water truck</li> <li>• May require contacting the local water purveyor (for larger ponds) to ensure that water service is not disrupted</li> <li>• No maximum test length provided</li> <li>• Some ponds will be too large for this test to be practical</li> </ul>	<p><b>Applicability</b></p> <p>Postconstruction verification of the drawdown time and infiltrative ability of a pond (used in the Spokane region)</p>

**Correction Factors for Subgrade Soils Underlying Infiltration BMPs**

The appropriate correction factor for application to in-situ measured (short-term) saturated hydraulic conductivity is determined by the type of testing, the number of tests in relation to the number of infiltration BMPs, the site variability, and the quality of the aggregate base material (permeable pavement only). Correction factors range from 0.33 to 1 (no correction) and are determined by a licensed professional.

See [Table 6.4: Correction Factors for In-Situ Ksat Measurements to Estimate Long-Term Design Infiltration Rates of Subgrade Soils Underlying Infiltration BMPs](#) to select appropriate correction factors to estimate long-term design infiltration rates based on measured (short-term) saturated hydraulic conductivity rates. Sufficient tests should be conducted so that soil infiltration capacity is fully characterized throughout the area where the infiltration BMPs are located. If enough infiltration tests are conducted for all infiltration BMPs to provide an accurate characterization or if uncertainty is low (e.g., conditions have been determined to be uniform through previous exploration and site geological factors), then no correction factor for site variability may be justified.

A correction factor should be applied to the measured (short-term) saturated hydraulic conductivity to account for the variability in field and laboratory test methods and the loss of infiltration capacity



over time. If the level of uncertainty is high, a correction factor near the low end of the range may be appropriate. The following are two example scenarios where low correction factors may apply:

- Site conditions are highly variable due to a deposit of ancient landslide debris or buried stream channels. In these cases, even with many explorations and several pilot infiltration tests, the level of uncertainty may still be high.
- Conditions are variable, but few explorations and only one PIT is conducted (e.g., the number of explorations and tests conducted do not match the degree of site variability anticipated).

The following guidelines apply to bioretention and permeable pavement BMPs:

- For bioretention, correction factors for siltation and bio-buildup are not necessary for bioretention area subgrades, because correction factors are applied to the bioretention soil media (BSM) to account for the influence of siltation. See [BMP T5.31: Bioretention](#).
- For permeable pavement:
  - The measured (short-term) saturated hydraulic conductivity with no correction factor may be used as the design infiltration rate for permeable pavement if a licensed engineer in the state of Washington determines that the aggregate base material is clean washed material with < 1% fines passing the No. 200 sieve.
  - If deemed necessary by the licensed professional, a correction factor may be applied to the measured (short-term) saturated hydraulic conductivity to determine the long-term design infiltration rate. Whether or not a correction factor is used (and the specific number that is used) depends on heterogeneity of the site soils, the number of infiltration tests in relation to the size of the installation, and the percentage fines passing the No. 200 sieve of the aggregate base material (see [Table 6.4: Correction Factors for In-Situ Ksat Measurements to Estimate Long-Term Design Infiltration Rates of Subgrade Soils Underlying Infiltration BMPs](#) for correction factors). The overlying pavement, if present, provides excellent protection for the underlying native soil from sedimentation; accordingly, the underlying subgrade soil profile does not require a correction factor for sediment input from sources above the pavement.

**Table 6.4: Correction Factors for In-Situ Ksat Measurements to Estimate Long-Term Design Infiltration Rates of Subgrade Soils Underlying Infiltration BMPs**

Site Analysis Issue or Method	Partial Correction Factor
Site variability and number of locations tested	$CF_v = 0.33$ to $1.0$
<b>Test method</b> <ul style="list-style-type: none"> <li>• Large-scale PIT</li> <li>• Small-scale PIT</li> <li>• Other small-scale (e.g. Double ring, falling head)</li> <li>• Grain Size Method (Massmann, 2008) <ul style="list-style-type: none"> <li>◦ Percent passing the U.S. No. 200 sieve is <math>&gt; 10</math></li> <li>◦ Percent passing the U.S. No. 200 sieve is <math>&lt; 10</math> but <math>&gt; 5</math></li> <li>◦ Percent passing the U.S. No. 200 sieve is <math>&lt; 5</math></li> </ul> </li> <li>• Spokane 200 Method (see latest version of the Spokane Regional Stormwater Manual)</li> </ul>	$CF_t =$ <ul style="list-style-type: none"> <li>• <math>0.75</math></li> <li>• <math>0.50</math></li> <li>• <math>0.40</math></li> <li>• As follows: <ul style="list-style-type: none"> <li>◦ <math>0.40</math></li> <li>◦ <math>0.50</math></li> <li>◦ <math>0.75</math></li> </ul> </li> <li>• Based on percent passing the U.S. No. 200 sieve as specified in the test method</li> </ul>
Degree of influent control to prevent siltation and bio-buildup	$CF_m = 0.9$ *Not required for bioretention or permeable pavement
Quality of pavement aggregate base material *Used for permeable pavement only	$CF_b = 0.9$ to $1.0$

Total Correction Factor,  $CF_T = CF_v \times CF_t \times CF_m \times CF_b$

- The design infiltration rate ( $K_{sat}$  design) is calculated by multiplying the initial  $K_{sat}$  by the total correction factor:

$$K_{sat} \text{ design} = K_{sat} \text{ initial} \times CF_T$$

**Design Criteria – Sizing BMPs**

The size of the infiltration BMP can be determined by routing the appropriate stormwater runoff through it. To prevent the onset of anaerobic conditions, the infiltration BMP must be designed to drain completely 72 hours after the flow to it has stopped.

Inflow to infiltration BMPs is calculated according to the methods described in [Chapter 4 - Hydrologic Analysis and Design](#). The storage volume in the pond, drywell, perforated pipe, or voids in the

gravel, is used to detain runoff prior to infiltration. The infiltration rate and size of the infiltration area are used in conjunction with the size of the storage area to design the facility.

In general, an infiltration BMP should have two discharge modes. The primary mode of discharge from an infiltration BMP is infiltration into the ground. However, when stormwater runoff exceeds the infiltration capacity and storage volume of the BMP, it will overflow. Overflows from an infiltration BMP must comply with the requirements of the local jurisdiction.

### ***Additional Design Criteria***

- Slope of the base of the infiltration BMP should be as flat as possible, generally < 3%.
- **Spillways/overflow structures:** A nonerodible outlet or spillway with a firmly established elevation must be constructed to discharge overflow. Ponding depth, drawdown time, and storage volume are calculated from that reference point.
- **Seepage analysis and control:** The project design should consider whether there would be any adverse effects caused by seepage zones on nearby building foundations, basements, roads, parking lots or sloping sites.

### ***Construction Criteria***

Infiltration trenches and basins should be excavated to final grade only after construction has been completed and all upgradient soil has been stabilized. Initial basin excavation should be conducted to within 1 foot of the final elevation of the basin floor. Any accumulation of silt in the infiltration BMP must be removed before putting it in service. After construction is completed, sediment should be prevented from entering the infiltration BMP by first conveying the runoff water through an appropriate pretreatment system such as a presettling basin, wetpond, or sand filter.

Infiltration BMPs should generally not be used as temporary sediment traps during construction. If an infiltration BMP is to be used as a sediment trap, it must not be excavated to final grade until after the upgradient contributing area has been stabilized.

Traffic Control – Relatively light-tracked equipment is recommended for use during construction of infiltration BMPs to avoid compaction of the basin floor. The use of draglines and trackhoes should be considered for constructing infiltration basins. The infiltration area should be flagged or marked to keep heavy equipment away.

### ***Verification of Performance***

During the initial operation, verification of BMP performance is recommended, along with a maintenance program that results in achieving expected performance levels. Installing and maintaining ground water monitoring wells is also encouraged. Water levels within installed ground water monitoring wells should be monitored on a periodic interval, particularly prior to, during, and following storm events, to evaluate ground water mounding impacts below and adjacent to the BMP.

### ***Operation and Maintenance Criteria***

- Provision should be made for regular and perpetual maintenance of the infiltration BMP, with adequate access.
- Maintenance should be conducted when water remains in the basin or trench for > 72 hours.

- An O&M manual, approved by the local jurisdiction, should ensure maintenance of the desired infiltration rate.
- Removal of accumulated debris/sediment in the basin/trench should be conducted every 6 months or as needed to prevent clogging, or when water remains in the pond > 72 hours.

### 6.3.4 Cold Climate Considerations

Infiltration BMPs can be effective in cold climates, but may be restricted by ground water quality concerns related to infiltration of chlorides associated with street deicing compounds. Frozen ground may inhibit the infiltration capacity of the ground. Grasses or other vegetation used in vegetated surface infiltration and bioinfiltration BMPs may also be dormant or ineffective at providing treatment mechanisms (e.g., filtration, pollutant uptake, etc.) during the winter. For vegetated BMPs, plants should be selected to be tolerant of cold and freezing climates. See [5.2.4 Cold Weather Considerations](#) for additional cold weather considerations. [BMP F6.24: Permeable Pavement](#) contains a section on considerations for freeze-thaw conditions that should be reviewed by the designer.

### 6.3.5 Arid and Semiarid Climate Considerations

For vegetated BMPs in arid/semiarid portions of eastern Washington, plants should be selected to be drought tolerant and not require watering after establishment (2 to 3 years). In more arid environments, watering may be needed during prolonged dry periods after plants are established.

### 6.3.6 BMPs for Infiltration

#### BMP F6.20: Drywells

This section covers design and maintenance criteria specific for drywells. Drywells are subject to Underground Injection Control (UIC) regulations; see [5.6 Subsurface Infiltration \(Underground Injection Control Wells\)](#).

Drywells are subsurface concrete structures, typically precast, that convey stormwater runoff into the soil matrix. They can be used as standalone structures, or as part of a larger drainage system (i.e., the overflow for a bioinfiltration swale).

#### General Criteria

[Figure 6.16: Typical Infiltration Drywell – City of East Wenatchee](#), [Figure 6.17: Typical Infiltration Drywell – Spokane County](#), and [Figure 6.18: Typical Infiltration Drywell – City of Kennewick](#) show typical infiltration drywell systems. These systems are designed as specified below. The following general requirements apply to design of drywells. Check with the local jurisdiction for outflow capacity or other local requirements:

- Drywell bottoms should be  $\geq 5$  feet above seasonal high ground water level or impermeable soil layers. See [5.4.3 General Criteria for Infiltration and Bioinfiltration BMPs](#).
- Drywells are typically a minimum of 48 inches in diameter and approximately 5 to 10 feet deep, or more.
- Geotextile may need to be placed on top of the drain rock and on trench or drywell sides prior

to backfilling to prevent migration of fines into the drain rock, depending on local soil conditions and local jurisdiction requirements.

- Drywells should be < 30 feet center to center or twice the depth, whichever is greater.
- Drywells should not be built on slopes > 25% (4H:1V).
- Drywells may not be placed on or above a landslide hazard area or slopes > 15% without evaluation by a licensed engineer in the state of Washington with geotechnical expertise or licensed geologist and jurisdiction approval.

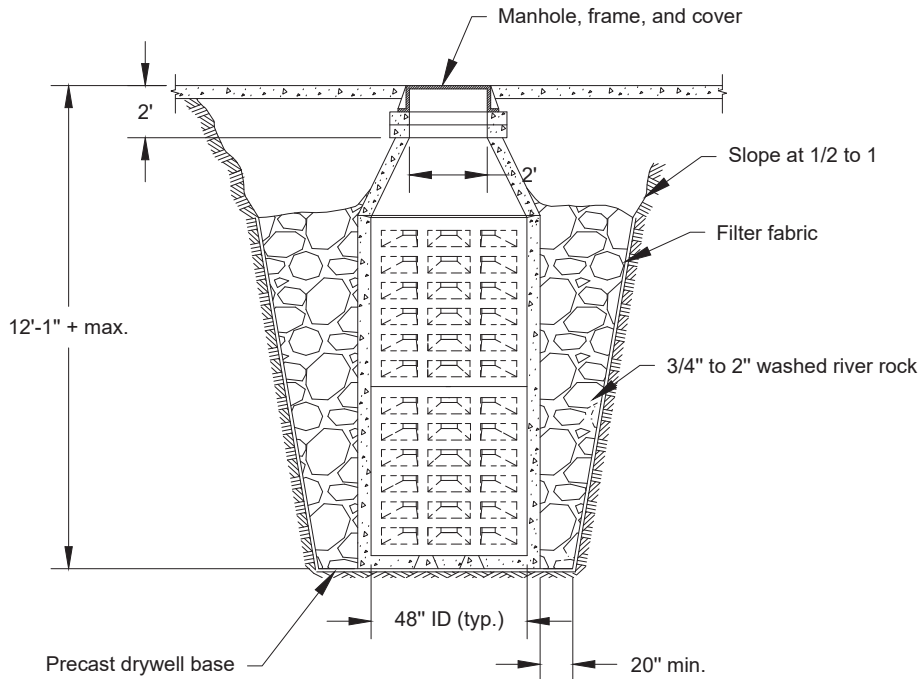
### ***Design Procedure***

See the design criteria in [6.3.3 General Criteria for Infiltration BMPs](#).

### ***Operation and Maintenance Criteria***

Remove debris and sediment from the drywell grate on a semiannual basis or as required to prevent the buildup of materials that could inhibit infiltration. See [Appendix 6-A: Recommended Maintenance Criteria for Flow Control BMPs](#) for additional maintenance recommendations for drywells.

**Figure 6.16: Typical Infiltration Drywell – City of East Wenatchee**



Notes:

1. Backfill above filter fabric to base of asphalt with crushed surfacing base course.
2. Size and spacing of drywells determined by drainage analysis.

NOT TO SCALE

Adapted from: RH2 Engineering, Inc.

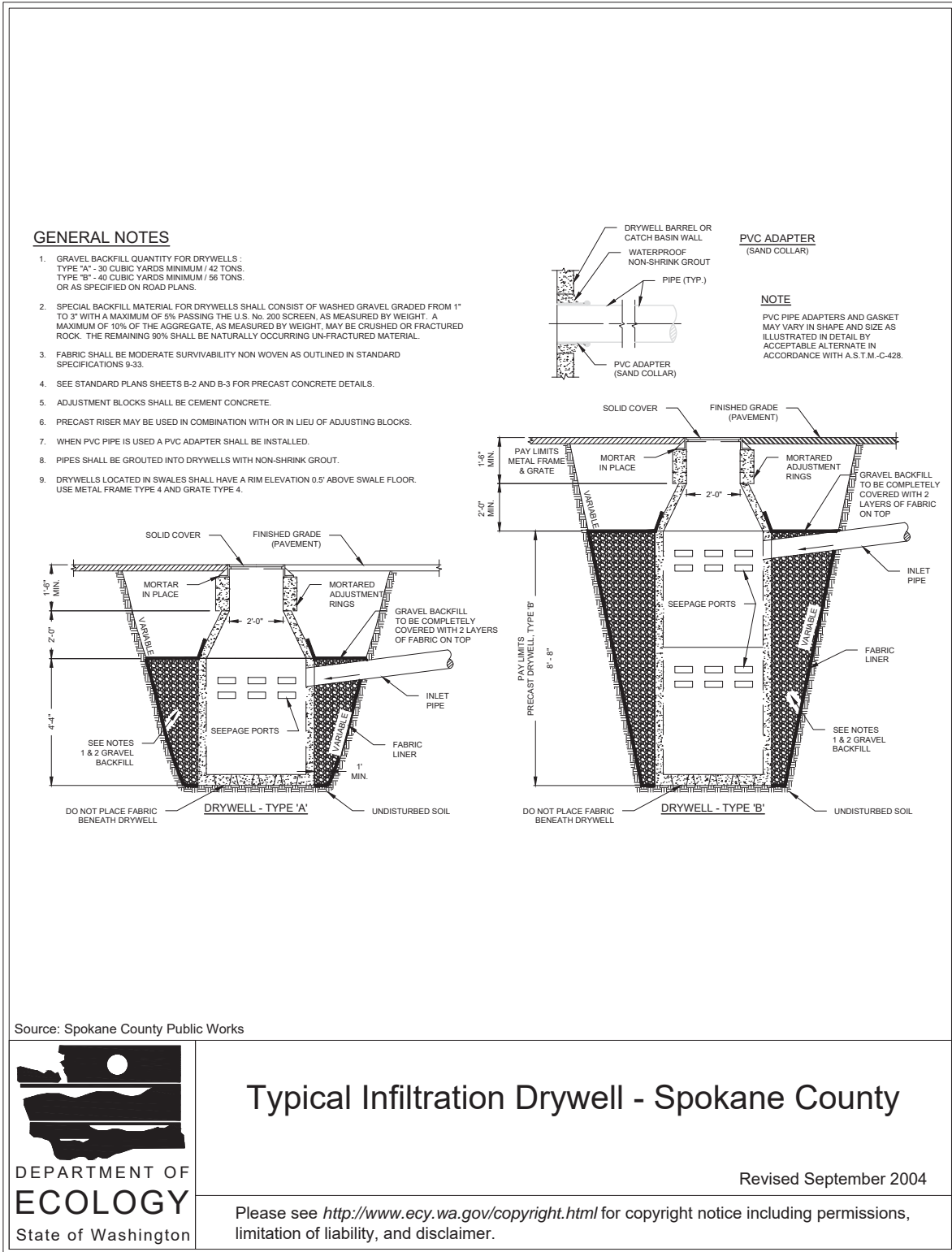


## Typical Infiltration Drywell - City of East Wenatchee

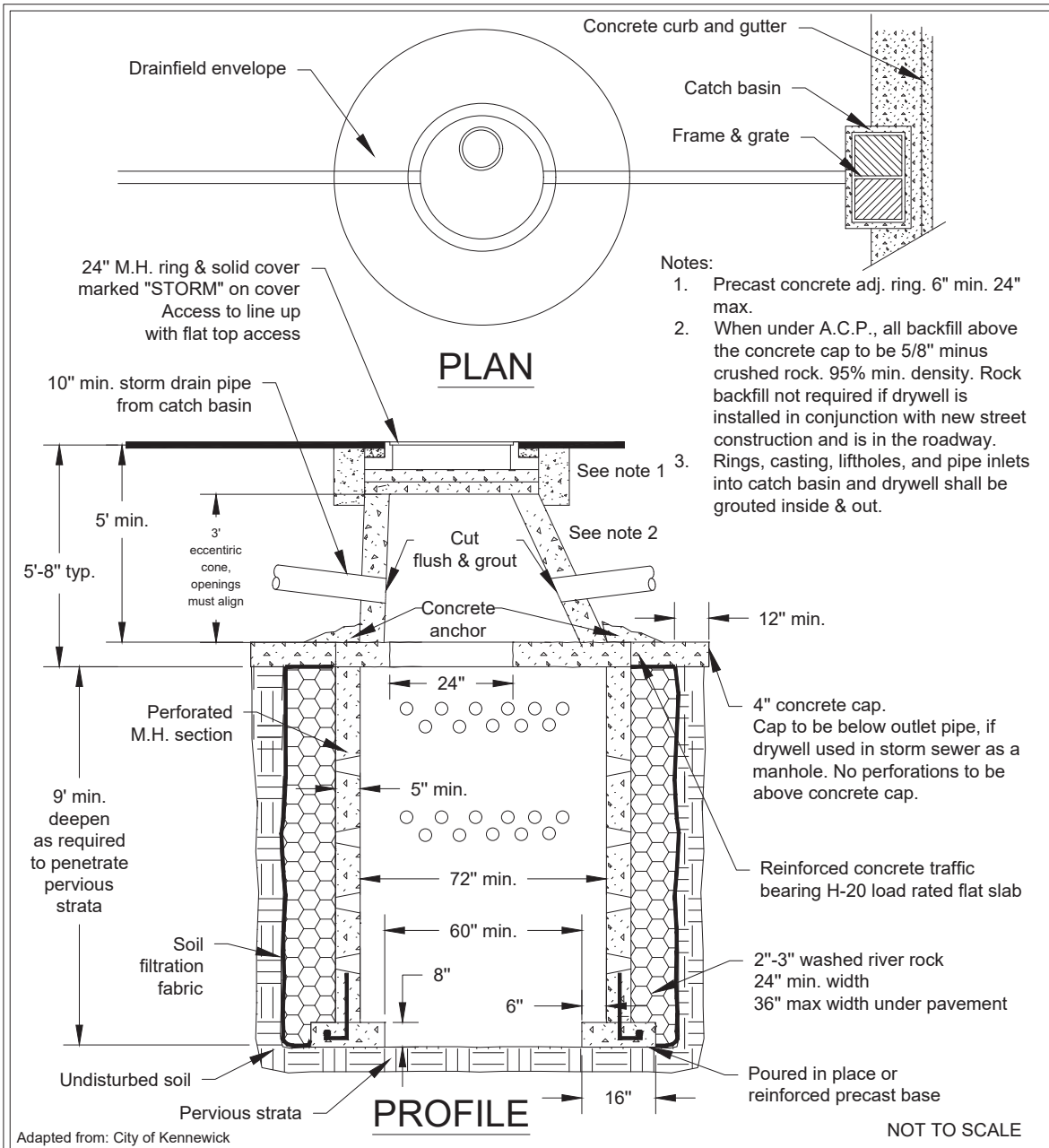
Revised September 2004

Please see <http://www.ecy.wa.gov/copyright.html> for copyright notice including permissions, limitation of liability, and disclaimer.

**Figure 6.17: Typical Infiltration Drywell – Spokane County**



**Figure 6.18: Typical Infiltration Drywell – City of Kennewick**



## Typical Infiltration Drywell - City of Kennewick

Revised September 2004

Please see <http://www.ecy.wa.gov/copyright.html> for copyright notice including permissions, limitation of liability, and disclaimer.



## BMP F6.21: Infiltration Ponds

Infiltration ponds are earthen impoundments used for the collection, temporary storage and infiltration of incoming stormwater runoff. This section covers design and maintenance criteria specific for infiltration ponds (see schematic in [Figure 6.19: Infiltration Pond With Settling Pond](#)). Infiltration ponds are not subject to Underground Injection Control (UIC) regulations (see [5.6 Subsurface Infiltration \(Underground Injection Control Wells\)](#)).

### General Criteria

See [6.3.3 General Criteria for Infiltration BMPs](#) for design infiltration rates. The following general criteria apply to design of infiltration ponds. Check with the local jurisdiction for outflow capacity and other local requirements:

- **Access:** Provide access for vehicles to easily maintain the forebay (presettling pond) area and minimize disturbance of vegetation or resuspension of sediment. See [6.2 Detention BMPs](#) for design criteria regarding access roads.
- **Freeboard:** Consult local jurisdiction requirements when establishing the design water surface elevation. A minimum of 1 foot of freeboard is recommended. Freeboard is measured from the rim of the infiltration BMP to the maximum ponding level or from the rim down to the overflow point if overflow or a spillway is included.
- **Lining material:** Ponds can be open or covered with a 6- to 12-inch layer of filter material such as coarse sand, or a suitable filter fabric to help prevent the buildup of impervious deposits on the soil surface. A nonwoven geotextile should be selected that will function sufficiently without plugging. The filter layer can be replaced or cleaned when/if it becomes clogged.
- **Vegetation:** The embankment, emergency spillways, spoil and borrow areas, and other disturbed areas should be stabilized and planted, preferably with grass, in accordance with the Stormwater Site Plan (see [Chapter 3 - Preparation of Stormwater Site Plans](#)). Without healthy vegetation the surface soil pores would quickly plug.

### Design Procedure

See design criteria in [6.3.3 General Criteria for Infiltration BMPs](#).

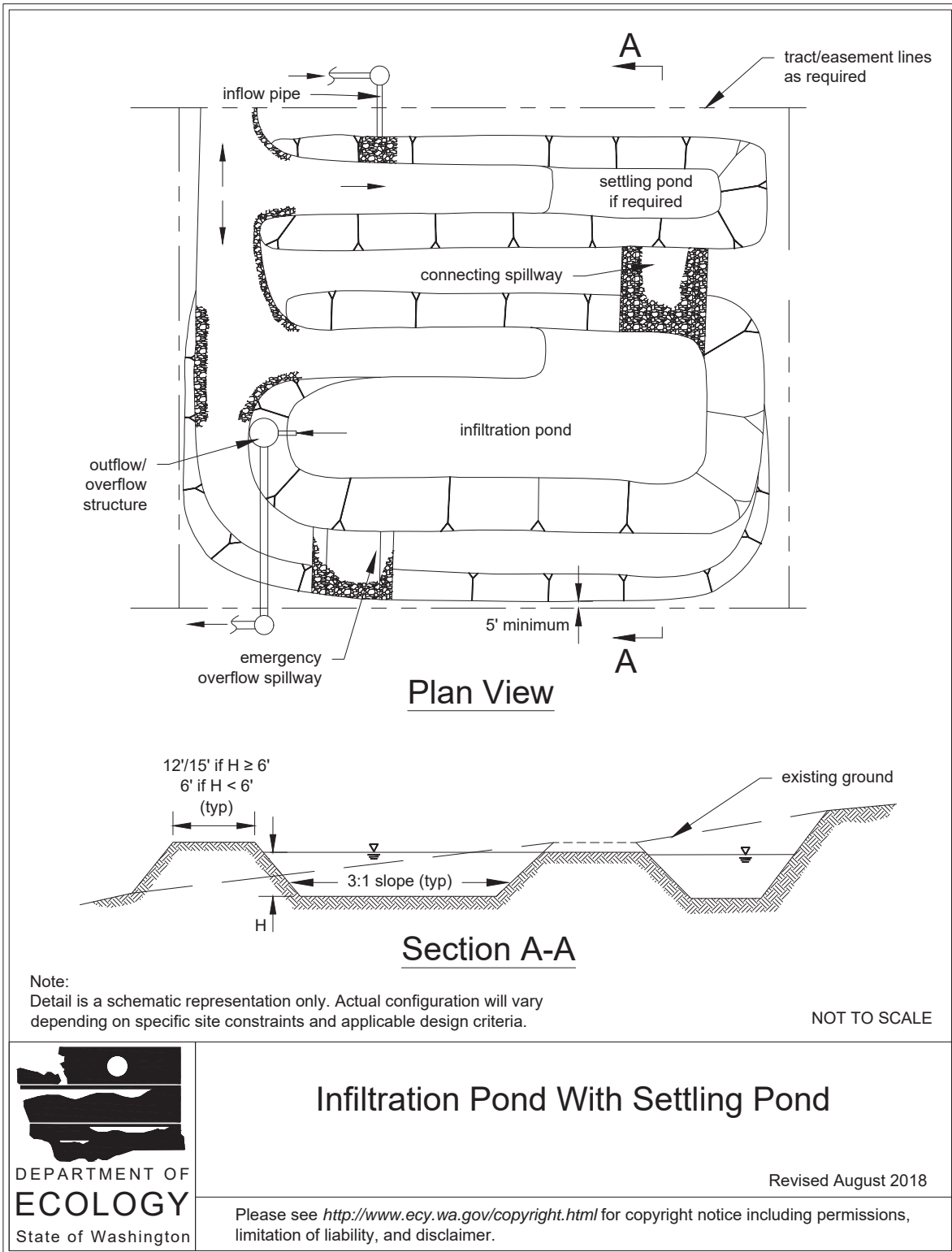
### Operation and Maintenance Criteria

- Maintain pond floor and side slopes to minimize erosion. This enhances infiltration, prevents erosion and consequent sedimentation of the pond floor, and prevents invasive weed growth. Where appropriate, bare spots are to be immediately stabilized and revegetated.
- Vegetation growth should be < 18 inches in height. Mow the slopes periodically and check for clogging, and erosion.
- Seed mixtures should be appropriate for the climate. The use of slow-growing, stoloniferous grasses will permit long intervals between mowing. Mowing twice a year is generally satisfactory for cool season grasses; native warm season grasses should be mowed once every 3 years to stimulate growth. Fertilizers should be applied only as necessary and in

limited amounts to avoid contributing to ground water pollution. Consult the local jurisdiction agency for appropriate fertilizer types, including slow release fertilizers, and application rates.

See additional maintenance recommendations for infiltration ponds in [Appendix 6-A: Recommended Maintenance Criteria for Flow Control BMPs](#).

**Figure 6.19: Infiltration Pond With Settling Pond**



## BMP F6.22: Infiltration Trenches

This section covers design, construction, and maintenance criteria specific for infiltration trenches. Underground Injection Control (UIC) regulations apply only when perforated pipe is installed in the trench; see [5.6 Subsurface Infiltration \(Underground Injection Control Wells\)](#). See [Figure 6.20: Typical Infiltration Trench/Pond](#), [Figure 6.21: Schematic of an Infiltration Trench](#), [Figure 6.22: Parking Lot Perimeter Trench Design](#), and [Figure 6.23: Median Strip Trench Design](#) for examples of trench designs.

### General Criteria

Infiltration trenches are generally  $\geq 24$  inches wide, and are backfilled with a coarse rock aggregate, allowing for temporary storage of stormwater runoff in the voids of the aggregate material. Stored runoff then gradually infiltrates into the surrounding soil. The surface of the trench can be covered with grating and/or consist of rock, gabion, sand, or a grassed covered area with a surface inlet. Perforated rigid pipe  $\geq 8$  inches in diameter can also be used to distribute the stormwater in a rock trench.

**Note:** Due to accessibility and maintenance limitations infiltration trenches must be carefully designed and constructed. The local jurisdiction should be contacted for additional specifications.

### Design Procedure

- See [Appendix 6-B: Guidelines for Site Characterization of Geotechnical Properties](#) or [Table 5.10: Infiltration Rates for Surface Infiltration and Bioinfiltration BMPs](#) for design infiltration rates. Check with the local jurisdiction for outflow capacity requirements.
- Access port: Consider including an access port or open or grated top for accessibility to conduct inspections and maintenance.
- Backfill material: The aggregate material for the infiltration trench should consist of a clean aggregate with a maximum diameter of 1.5 inches and a minimum diameter of 3/8 inches conforming to the Gravel Backfill for Drywells specification in the current version of the WSDOT Standard Specifications. For calculations assume a void space of 30% maximum.
- Perforated pipe: A minimum of 8-inch perforated pipe should be provided to increase the storage capacity of the infiltration trench and to enhance conveyance of flows throughout the trench area.
- Geotextile: The aggregate fill material shall be completely encased in an engineering geotextile material. In the case of an aggregate surface, geotextile should surround all of the aggregate fill material except for the top 1 foot, which is placed over the geotextile. Geotextile fabric with acceptable properties must be carefully selected to avoid plugging.
- The bottom sand or geotextile fabric is optional.
- See the latest version of the WSDOT Design Manual, for information on functions and applications, types and characteristics, and design approaches for geosynthetics. The latest version of the WSDOT Standard Specifications includes specifications for geotextiles, classed pursuant to the WSDOT Design Manual discussions and definitions.
- See *Geosynthetic Design and Construction Guidelines* ([FHWA, 1998](#)) for design guidance on

geotextiles in drainage applications. See the *NCHRP Long-Term Performance of Geosynthetics in Drainage Applications* ([NCHRP, 1994](#)), for long-term performance data and background on the potential for geotextiles to clog, blind, or to allow piping to occur and how to design for these issues.

- **Surface cover:** A rock-filled trench can be placed under a porous or impervious surface cover to conserve space.
- **Observation well:** An observation well should be installed at the lower end of the infiltration trench to check water levels, drawdown time, sediment accumulation, and conduct water quality monitoring. [Figure 6.24: Observation Well Details](#) illustrates observation well details. It should consist of a perforated polyvinyl chloride (PVC) pipe that is 4 to 6 inches in diameter, and it should be constructed flush with the ground elevation. For larger trenches, a 12- to 36-inch-diameter well can be installed to facilitate maintenance operations such as pumping out the sediment. The top of the well should be capped to discourage vandalism and tampering.
- **Catch basin and tee:** A tee section should be provided in the nearest catch basin upstream of the infiltration trench if a catch basin is used. The tee will trap floatable debris and oils.

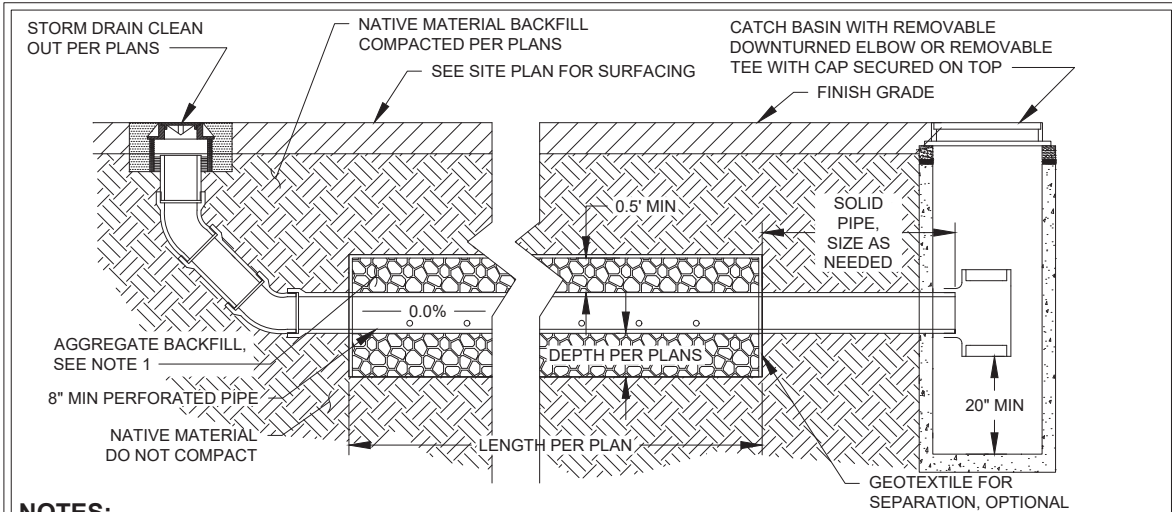
## **Construction Criteria**

- **Trench preparation:** Excavated materials must be placed away from the trench sides to enhance trench wall stability. Care should also be taken to keep this material away from slopes, neighboring property, sidewalks and streets. It is recommended that this material be covered with plastic.
- **Rock aggregate placement and compaction:** The rock aggregate should be placed in lifts and compacted using plate compactors. As a rule of thumb, a maximum loose lift thickness of 12 inches is recommended. The compaction process ensures geotextile conformity to the excavation sides, thereby reducing potential piping and geotextile clogging, and settlement problems.
- **Potential contamination:** Prevent natural or fill soils from intermixing with the rock aggregate. All contaminated stone aggregate must be removed and replaced with uncontaminated rock aggregate.
- **Overlapping and covering:** Following the rock aggregate placement, the geotextile must be folded over the rock aggregate to form a 12-inch minimum longitudinal overlap. When overlaps are required between rolls, the upstream roll should overlap a minimum of 2 feet over the downstream roll in order to provide a shingled effect.
- **Voids behind geotextile:** Voids between the geotextile and excavation sides must be avoided. Removing boulders or other obstacles from the trench walls is one source of such voids. Natural soils should be placed in these voids at the most convenient time during construction to ensure geotextile conformity to the excavation sides. Soil piping, geotextile clogging, and possible surface subsidence should be avoided by this remedial process.
- **Unstable excavation sites:** Vertically excavated walls may be difficult to maintain in areas where the soil moisture is high or where soft or cohesionless soils predominate. Trapezoidal, rather than rectangular, cross sections may be needed.

### ***Operation and Maintenance Criteria***

Sediment buildup in the top foot of rock aggregate or the surface inlet should be monitored on the same schedule as the observation well.

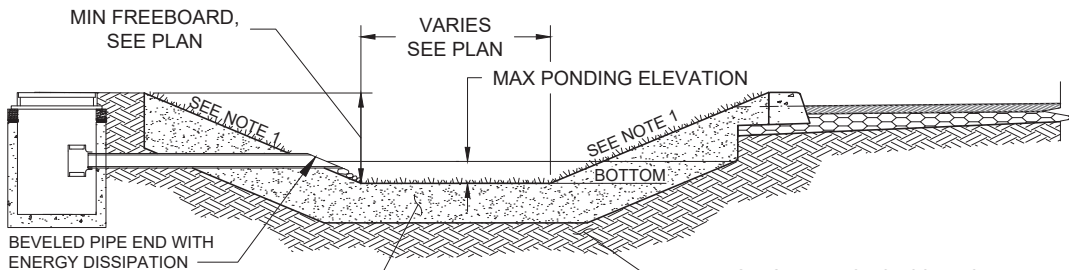
**Figure 6.20: Typical Infiltration Trench/Pond**



**NOTES:**

1. AGGREGATE BACKFILL SHOULD CONSIST OF A CLEAN AGGREGATE WITH A MAXIMUM DIAMETER OF 1.5 INCHES AND MINIMUM DIAMETER OF 3/8 INCHES CONFORMING TO THE GRAVEL BACKFILL FOR DRYWELLS SPECIFICATION IN THE CURRENT VERSION OF THE WSDOT STANDARD SPECIFICATIONS.
2. THE TRENCHES SHALL BE EXCAVATED PER PLAN. CONTRACTOR TO ENSURE TRENCH BOTTOMS ARE NOT COMPACTED.
3. DURING CONSTRUCTION CARE SHALL BE EXERCISED TO PREVENT NATURAL OR FILL SOILS FROM INTERMIXING WITH THE STONE AGGREGATE. ALL CONTAMINATED AGGREGATE SHALL BE REMOVED AND REPLACED WITH UNCONTAMINATED STONE AGGREGATE.

**LONGITUDINAL SECTION**



**NOTES:**

1. INFILTRATION POND BOTTOM AND SIDE SLOPES GRADED AND VEGETATED PER LOCAL REQUIREMENTS.
2. AMENDED SOIL MAY BE REQUIRED TO MEET SSC-6 IF INFILTRATION POND USED TO MEET RUNOFF TREATMENT REQUIREMENTS.
3. OVERFLOW TO CATCH BASIN, DRYWELL, OR OTHER APPROVED OVERFLOW DEVICE PER PLANS.

Adapted from: AHBL, Inc.

**INFILTRATION POND DETAIL**

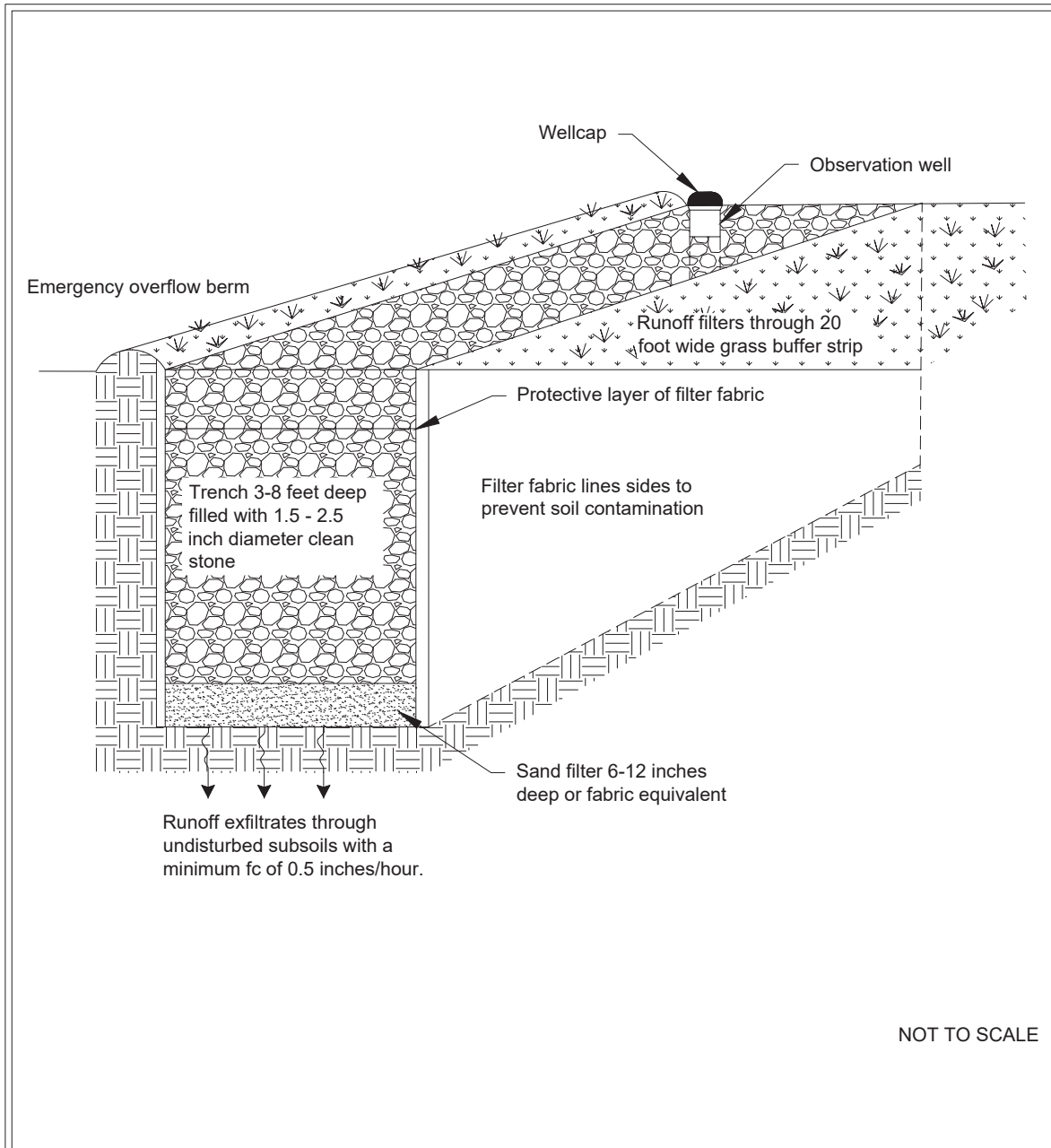


**Typical Infiltration Trench/Pond**

Revised August 2018

Please see <http://www.ecy.wa.gov/copyright.html> for copyright notice including permissions, limitation of liability, and disclaimer.

**Figure 6.21: Schematic of an Infiltration Trench**



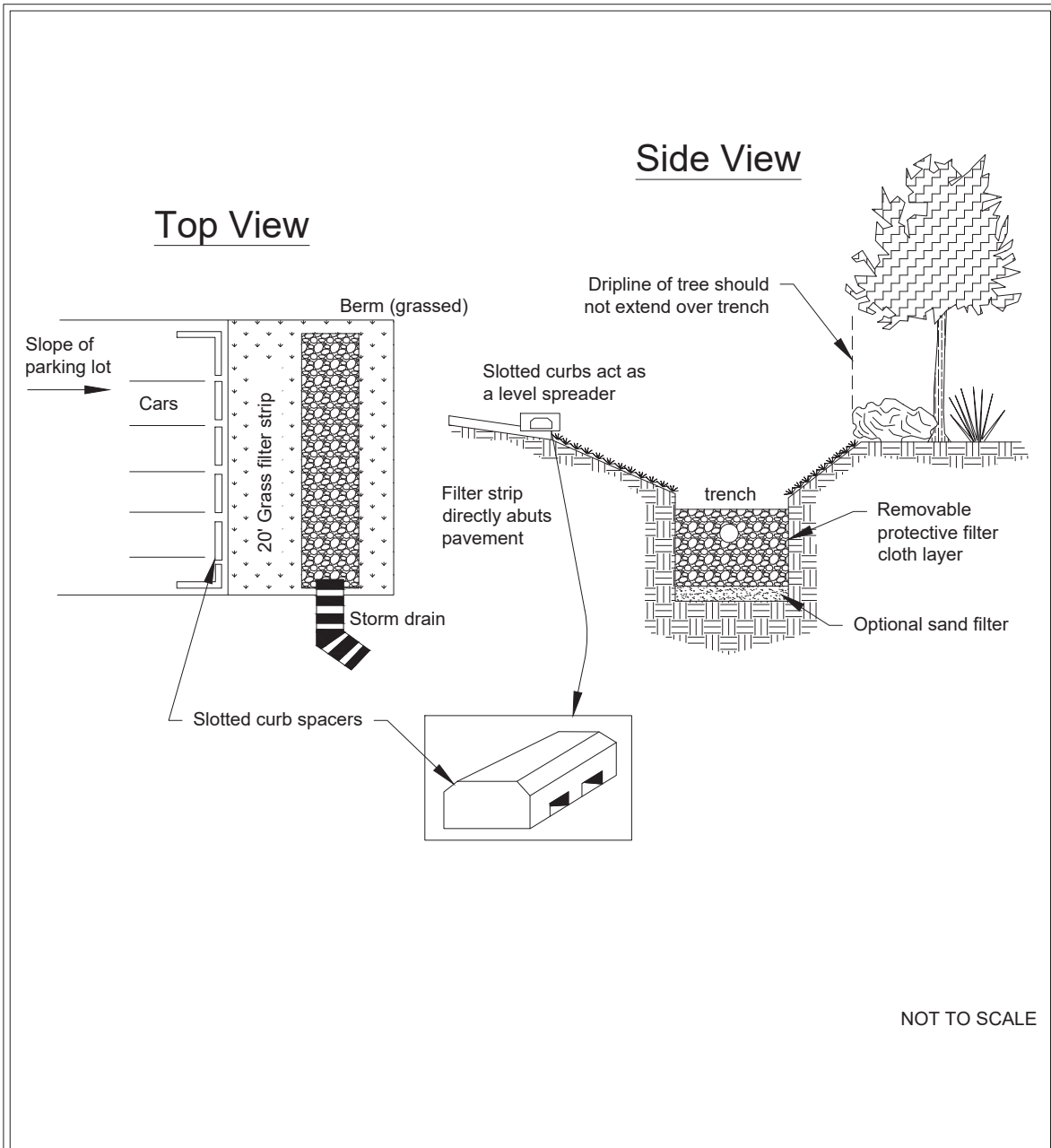
## Schematic of an Infiltration Trench

Revised June 2016

Please see <http://www.ecy.wa.gov/copyright.html> for copyright notice including permissions, limitation of liability, and disclaimer.



**Figure 6.22: Parking Lot Perimeter Trench Design**

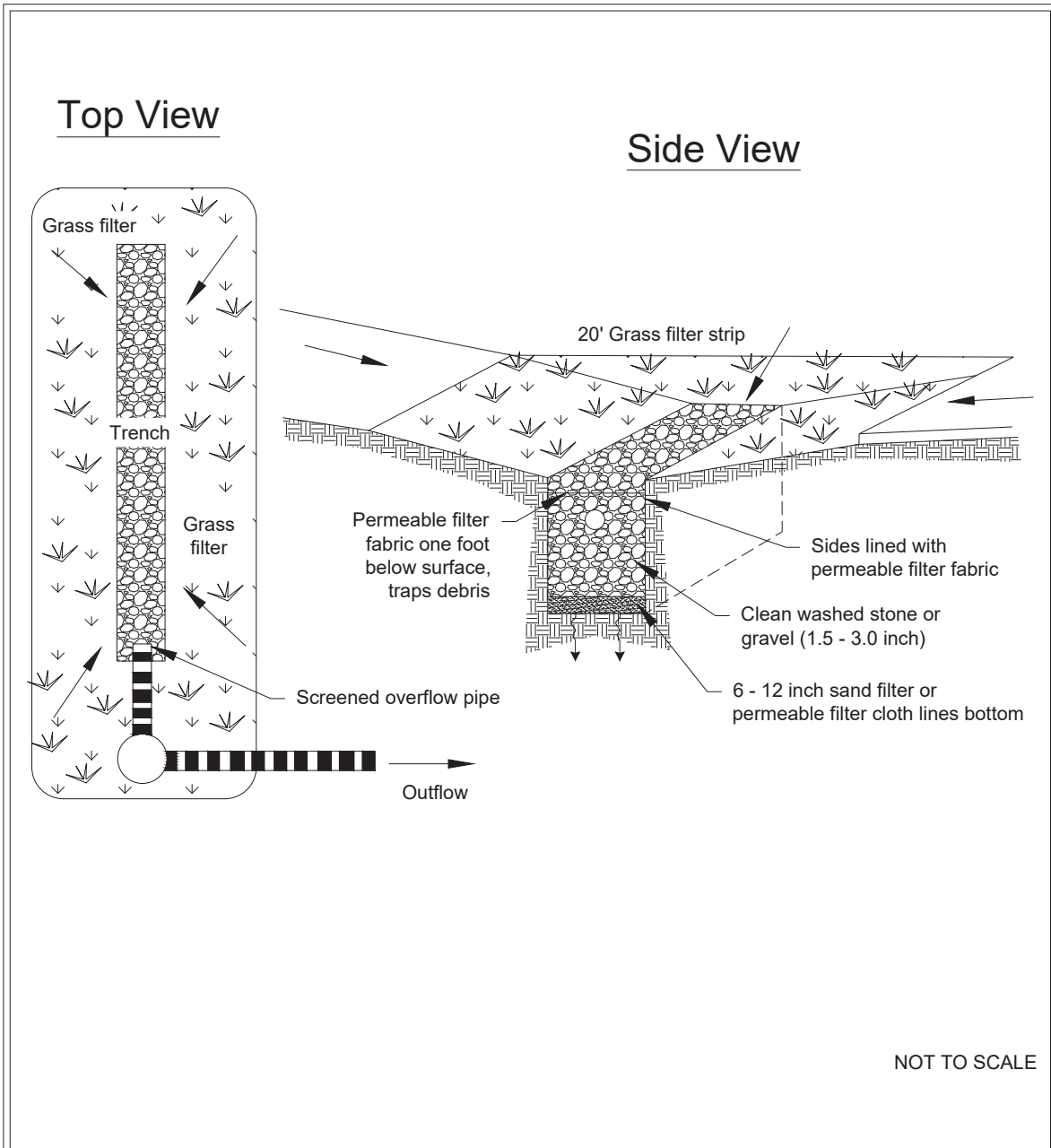


## Parking Lot Perimeter Trench Design

Revised June 2016

Please see <http://www.ecy.wa.gov/copyright.html> for copyright notice including permissions, limitation of liability, and disclaimer.

**Figure 6.23: Median Strip Trench Design**

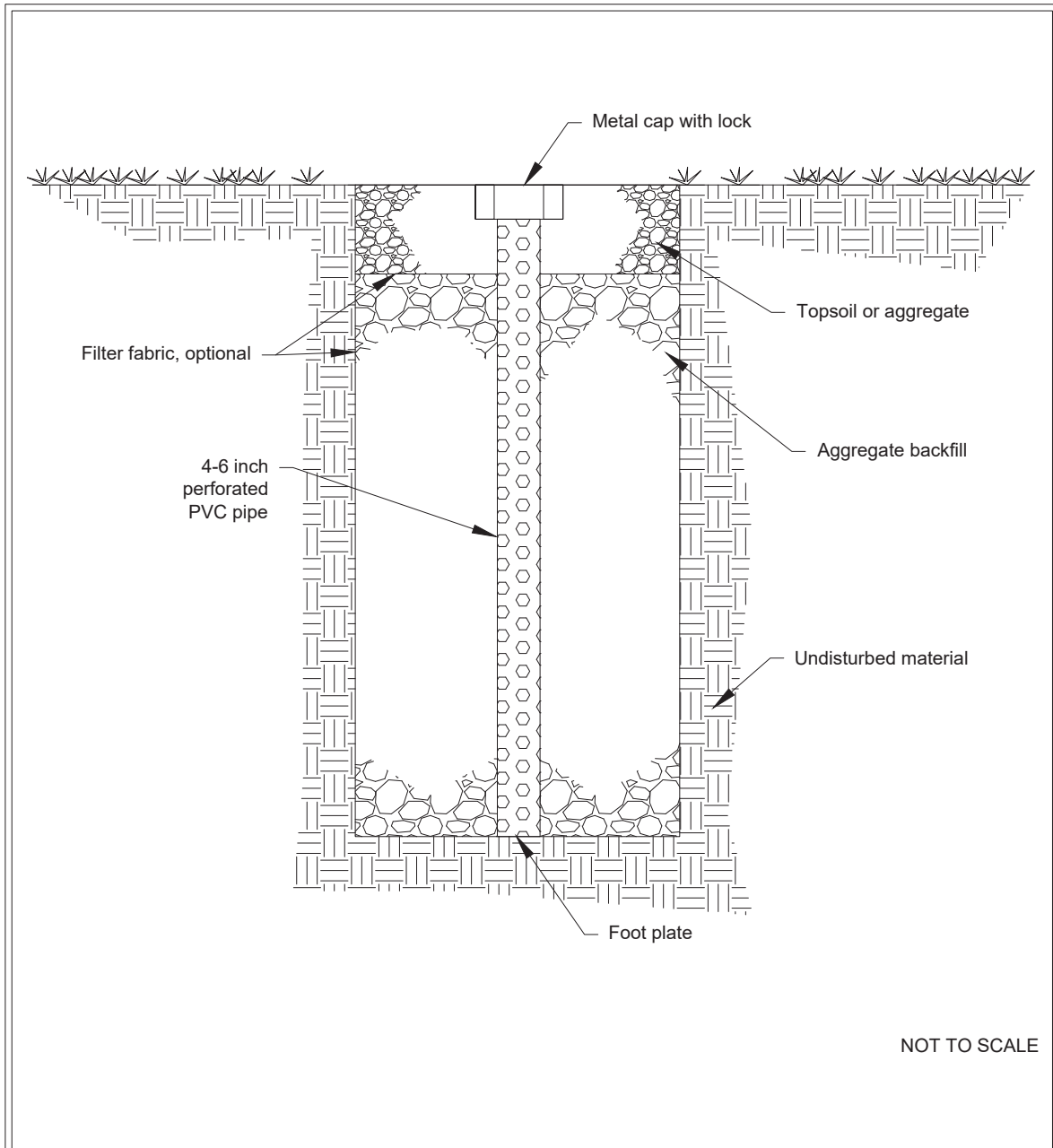


## Median Strip Trench Design

Revised June 2016

Please see <http://www.ecy.wa.gov/copyright.html> for copyright notice including permissions, limitation of liability, and disclaimer.

**Figure 6.24: Observation Well Details**



## Observation Well Details

Revised August 2018

Please see <http://www.ecy.wa.gov/copyright.html> for copyright notice including permissions, limitation of liability, and disclaimer.

## BMP F6.23: Bioretention

See [5.4.7 BMPs for Surface Infiltration and Bioinfiltration](#) for detailed guidance on siting, design, construction, operation, and maintenance of bioretention BMPs. Design of bioretention for flow control is equivalent to design of bioretention for runoff treatment, except that the minimum bioretention soil media depth is 12 inches, rather than 18 inches. See [6.3.4 Cold Climate Considerations](#) for modeling procedures to be used for sizing bioretention BMPs to meet [2.7.7 Core Element #6: Flow Control](#).

## BMP F6.24: Permeable Pavement

Pavement for vehicle and pedestrian travel generates roughly twice the impervious surface cover of buildings. While essential for the movement of people, goods, and services, pavement used by vehicles generates significant levels of heavy metals and most hydrocarbon pollutants in stormwater ([Ferguson, 2005](#)). The concentration of pollutants (specifically metals and hydrocarbons) in surface flow from pavement used by vehicles, in general, increases with traffic intensity ([Ferguson, 2005](#)), ([Colandini et al., 1995](#)).

Both pedestrian and vehicle pavements also contribute to increased peak flow, flow durations, and associated physical habitat degradation of streams and wetlands. Effective management of stormwater quality and quantity from paved surfaces is, therefore, critical for improving fresh water conditions in eastern Washington.

Properly designed, constructed, and maintained permeable pavement can be an effective design solution in cold weather climates. Permeable pavement use is geographically widespread throughout the United States and has been used in arid climates such as Tucson, Arizona, wet climates such as areas of western Washington and Florida, and areas with significant seasonal temperature variation such as Ohio and Minnesota.

Permeable pavement can be designed to accommodate pedestrian, bicycle, and auto traffic while allowing infiltration, treatment, and storage of stormwater. The general categories of permeable pavement include the following:

- **Porous hot or warm-mix asphalt pavement:** A flexible pavement similar to standard asphalt that uses a bituminous binder to adhere aggregate together. However, the fine material (sand and finer) is reduced or eliminated and, as a result, voids form between the aggregate in the pavement surface and allow water to infiltrate.
- **Pervious Portland cement concrete:** A rigid pavement similar to conventional concrete that uses a cementitious material to bind aggregate together. However, the fine aggregate (sand) component is reduced or eliminated in the gradation and, as a result, voids form between the aggregate in the pavement surface and allow water to infiltrate.
- **Permeable interlocking concrete pavements (PICPs) and aggregate pavers:** PICPs are solid, precast, manufactured modular units. The solid pavers are impervious, high-strength Portland cement concrete manufactured with specialized production equipment. Pavements constructed with these units create joints that are filled with permeable aggregates and installed on an open-graded aggregate bedding course.

Aggregate pavers (sometimes called pervious pavers) are a different class of pavers from PICIP. These include modular precast paving units made with similar-sized aggregates bound together with Portland cement concrete with high-strength epoxy or other adhesives. Like PICIP, the joints or openings in the units are filled with open-graded aggregate and placed on an open-graded aggregate bedding course. Aggregate pavers are intended for pedestrian use only.

- **Grid systems made of concrete or plastic:** Concrete units are precast in a manufacturing facility, packaged and shipped to the site for installation. Plastic grids typically are delivered to the site in rolls or sections. The openings in both grid types are filled with topsoil and grass or permeable aggregate. Plastic grid sections connect together and are pinned into a dense-graded base, or are eventually held in place by the grass root structure. Both systems can be installed on an open-graded aggregate base as well as a dense-graded aggregate base.

## General Criteria

Nomenclature for permeable pavement varies among designers, installers, and geographic regions. For the Stormwater Management Manual for Eastern Washington (manual), permeable pavement is used to describe the general category of pavements that are designed to allow infiltration through the pavement section. The following terms are used throughout this manual and represent the major categories of permeable pavements that carry vehicle as well as pedestrian traffic: pervious concrete, porous asphalt, permeable interlocking concrete pavements, and concrete and plastic grid pavements.

## Applications

Typical applications for permeable pavement include industrial site employee parking, commercial parking, sidewalks, pedestrian and bike trails, driveways, residential access roads, and emergency and facility maintenance roads. Grid pavers are not intended for streets but are often used for emergency access lanes and intermittently used (overflow) parking areas. All other types of permeable pavement can withstand loads from the number of trucks associated with local roads. Specialized engineering expertise is required for designs for heavy loads and cold weather considerations.

Thoroughfares, highways, and other roads that combine high vehicle loads and high-speed traffic are generally not considered appropriate for permeable pavements. However, porous asphalt has proven structurally sound and remained permeable in a few arterial and highway applications ([Hossain et al., 1992](#)) and pervious concrete and permeable interlocking concrete pavement have been successfully used in industrial settings with low speeds and high vehicle loads.

## Water Quality Treatment

Currently, Ecology does not offer a water quality treatment credit for stormwater passing through a standard permeable pavement wearing course or the aggregate base. However, one of the following design approaches can be used for treatment:

- Allow the runoff to infiltrate subgrade soils that have a cation exchange capacity  $\geq 5$  milliequivalents (meq)/100 grams dry soil, minimum organic matter content of 0.5%, and a maximum infiltration rate of 12 inches per hour (in/hr), short-term or measured rate. The soil must have the above characteristics for a minimum depth of 18 inches.

- Design a 6-inch treatment layer into the aggregate base that has the characteristics described above for subgrade soils.

### **Freeze-Thaw Conditions**

Properly designed permeable pavement installations have performed well in the midwestern and northeastern United States, where freeze-thaw cycles are severe ([Adams, 2003](#)), ([Wei, 1986](#)). Cold weather design guidance from the University of New Hampshire is recognized in many areas (e.g., Michigan and Ohio) as the foremost guidance for the design of permeable pavements in cold weather climates ([UNHSC, 2009](#)). Design strategies for freeze-thaw conditions, such as use of underdrains to limit subsurface saturation, are presented below.

Permeable pavement should not be used (unless additional engineering analysis and design are conducted) where the following conditions are present:

- Excessive sediment is deposited on the surface (e.g., construction and landscaping material yards).
- Steep erosion prone areas are upslope of the permeable surface and will likely deliver sediment and clog pavement on a regular basis, and where maintenance is not conducted regularly.
- Concentrated pollutant spills are possible, such as gas stations, truck stops and industrial chemical storage sites, and where infiltration will result in the transport of pollutants to deeper soil or ground water.
- Seasonally high ground water is within 1 foot of the bottom of the aggregate base (interface of the subgrade and aggregate base).
- Fill soils, when saturated, cannot be adequately stabilized.
- Sites receive regular, heavy applications of sand (such as weekly) for maintaining traction during winter.
- Steep slopes where water within the aggregate base layer or at the subgrade surface cannot be controlled by detention structures (e.g., check dams) and may cause erosion and structural failure, or where surface runoff velocities may preclude adequate infiltration at the pavement surface. Note that permeable pavement has been used successfully on slopes up to 10% with subsurface detention structures and at 8% slopes without subsurface structures.

Slope restrictions result primarily from flow control concerns and to a lesser degree the structural limitations of the permeable pavement. Steep gradients increase surface and subsurface flow velocities and reduce infiltration capability and storage capacity of the pavement system. Detention structures placed on the subgrade and below the pavement can be used to detain subsurface flow and increase infiltration and maximum slope recommendation.

### **Adequate Site Analysis and Appropriate Site Application**

Adequate site analysis and the selection of the proper practice and materials within the context of the physical setting and development needs are critical. Important considerations include the following:

- Snow storage
- Snow removal
- Vehicle use
- Soil type and permeability
- Depth to ground water
- Topography and the potential for sediment inputs to the permeable pavement
- Surrounding pollution generating land uses
- Surrounding vegetation
- Maintenance needs

### **Correct Design Specifications**

There are many design needs common to most permeable pavements and some unique aspects to each system. Industry associations can assist with design and specification guidance. Common and system-specific design needs are provided in detail later in this section. In brief, they include proper site preparation, correct aggregate base, pavement surface mix design, geotextile separation layer (if included), and underdrain design (if included). All are essential for adequate infiltration, storage, and release of storm flows as well as structural integrity. Construction specifications should stipulate that contractors on the job site hold certificates from industry programs on installing their systems. The pervious concrete and permeable interlocking concrete paver industry associations offer such education programs for contractors. Specifications should also include contractor experience with projects of similar size and scope.

### ***Design Procedure***

1. Select a permeable pavement type based on site characteristics (slope) and preferred aesthetic
2. Determine if water quality treatment is needed.
3. Determine subgrade infiltration rate including correction factor, if necessary.
4. Determine if an underdrain is required. Soils with lower infiltration rates (e.g., < 0.3 in/hr) may require underdrains or elevated drains to prevent periodic saturated conditions within 6 inches of the bottom of the aggregate base (interface of the subgrade and aggregate base).
5. Model the contributing basin runoff into the permeable pavement.
6. Model the permeable pavement with level-pool routing per [4.7 Level-Pool Routing Method](#) with the subgrade infiltration rate. Determine the maximum water surface elevation accounting for the void space in the storage bed.
7. Size the storage bed depth below the first overflow, or underdrain elevation, as determined in Step 4 above.

8. Consider increasing the storage depth if the depth calculated in Step 4 above is less than the frost depth.

Mix designs for permeable pavement systems are different from conventional pavement systems. For successful application of any permeable pavement system the subsequent basic guidelines presented in the following sections must be followed.

[Table 6.5: Sizing Methods and Assumptions for Permeable Pavement](#) summarizes the methods and assumptions for the above steps for sizing permeable pavement systems.



**Table 6.5: Sizing Methods and Assumptions for Permeable Pavement**

Step	Variable	Methods and Assumptions <sup>a</sup>
1	Slope	<ul style="list-style-type: none"> <li>• Minimum slope = 1% to 2% to allow for surface overflow in extreme rainfall</li> <li>• Consider detention structures on slopes &gt; 3%</li> <li>• General recommendations for maximum slopes for permeable pavement are as follows:               <ul style="list-style-type: none"> <li>◦ Porous asphalt: 5%</li> <li>◦ Pervious concrete: 12%</li> <li>◦ Permeable interlocking concrete pavers: 12%</li> <li>◦ Concrete and plastic grid systems: maximum slope recommendations vary by manufacturer and generally range from 6% to 12% (primarily a traction rather than infiltration or structural limitation). Contact the manufacturer or local supplier for specific product recommendations.</li> </ul> </li> </ul>
2	Water Quality Treatment	<ul style="list-style-type: none"> <li>• Minimum = 18 inches (native soils meeting CEC, OM, and infiltration rate requirements)</li> <li>• Minimum = 6 inches (imported media [sand] treatment layer)</li> </ul>
3	Long-Term Infiltration Rate of Subgrade Soils	<ul style="list-style-type: none"> <li>• Estimate the infiltration rate of subgrade soils per <a href="#">6.3.3 General Criteria for Infiltration BMPs</a>.</li> <li>• Apply correction factors as needed per <a href="#">6.3.3 General Criteria for Infiltration BMPs</a>.</li> </ul>
4	Underdrain Pipe	<ul style="list-style-type: none"> <li>• Minimum pipe diameter = 4 inches</li> <li>• Minimum slope = 0.5%</li> <li>• Minimum orifice diameter (if needed) = 0.5 inches</li> <li>• Invert elevation per design</li> </ul>

**Table 6.5: Sizing Methods and Assumptions for Permeable Pavement  
(continued)**

Step	Variable	Methods and Assumptions <sup>a</sup>
5	Modeling Approach for Porous Asphalt or Concrete	<ol style="list-style-type: none"> <li>1. Base material laid above surrounding grade               <ol style="list-style-type: none"> <li>a. Without underlying perforated drain pipes                   <ul style="list-style-type: none"> <li>• Model surface as: grass over underlying soil type (e.g., Hydrologic Soil Group A, B, C, D)</li> </ul> </li> <li>b. With underlying perforated drain pipes                   <ul style="list-style-type: none"> <li>• Model surface as: impervious surface</li> </ul> </li> </ol> </li> <li>2. Base material laid partially or completely below surrounding grade               <ol style="list-style-type: none"> <li>a. Without underlying perforated drain pipes                   <ul style="list-style-type: none"> <li>• Model surface as:                       <ol style="list-style-type: none"> <li>○ Option 1: grass over underlying soil type</li> <li>○ Option 2: impervious surface routed to an infiltration BMP</li> </ol> </li> </ul> </li> <li>b. With underlying perforated drain pipes at or below bottom of base layer                   <ul style="list-style-type: none"> <li>• Model surface as: impervious surface</li> </ul> </li> <li>c. With underlying perforated drain pipes elevated within the base course                   <ul style="list-style-type: none"> <li>• Model surface as:                       <ol style="list-style-type: none"> <li>○ If the perforated pipes are designed to distribute runoff directly below the wearing surface and the pipes are above the surrounding grade, then follow directions for 2a Option 1 above;</li> <li>○ otherwise, follow directions for 2a Option 2</li> </ol> </li> </ul> </li> </ol> </li> </ol>

**Table 6.5: Sizing Methods and Assumptions for Permeable Pavement  
(continued)**

Step	Variable	Methods and Assumptions <sup>a</sup>
5	Modeling Approach for Plastic or Concrete Grids or PICP	<ol style="list-style-type: none"> <li>1. Base material laid above surrounding grade               <ol style="list-style-type: none"> <li>a. Without underlying perforated drain pipes                   <ul style="list-style-type: none"> <li>• Plastic or concrete grids model surface as: grass over underlying soil type</li> <li>• PICP model surface as: 50% grass on underlying soil; 50% impervious</li> </ul> </li> <li>b. With underlying perforated drain pipes                   <ul style="list-style-type: none"> <li>• Model surface as: impervious surface</li> </ul> </li> </ol> </li> <li>2. Base material laid partially or completely below surrounding grade               <ol style="list-style-type: none"> <li>a. Without underlying perforated drain pipes                   <ul style="list-style-type: none"> <li>• Model surface as:                       <ul style="list-style-type: none"> <li>◦ Option 1 (plastic or concrete grids): grass over underlying soil type</li> <li>◦ Option 1 (PICP): 50% grass; 50% impervious</li> <li>◦ Option 2: impervious surface routed to an infiltration BMP</li> </ul> </li> </ul> </li> <li>b. With underlying perforated drain pipes at or below bottom of base layer                   <ul style="list-style-type: none"> <li>• Model surface as: impervious surface</li> </ul> </li> <li>c. With underlying perforated drain pipes to collect stormwater elevated within the base course                   <ul style="list-style-type: none"> <li>• Model surface as:                       <ul style="list-style-type: none"> <li>◦ If the perforated pipes are designed to distribute runoff directly below the wearing surface and the pipes are above the surrounding grade, then follow directions for 2a above;</li> <li>◦ otherwise, model surface as impervious surface routed to infiltration BMP</li> </ul> </li> </ul> </li> </ol> </li> </ol>
6	Water Surface Elevation	Per design
7	Storage Bed Depth	Per design

**Table 6.5: Sizing Methods and Assumptions for Permeable Pavement  
(continued)**

Step	Variable	Methods and Assumptions <sup>a</sup>
8	Adjusted Storage Bed Depth	4 inches below the frost line is recommended
<sup>a</sup> See local jurisdiction requirements for locally required methods and assumptions where applicable.		

In the runoff modeling, similar permeable pavement designs throughout a development can be summed and represented as one large BMP. For instance, walkways can be summed into one BMP. Driveways with similar designs (and enforced through deed restrictions) can be modeled as a single BMP. In these instances, a weighted average of the design infiltration rates for each location may be used. The averages are weighted by the size of their contributing area. The design infiltration rate for each site is the measured infiltration rate multiplied by the appropriate correction factors (see [6.3.3 General Criteria for Infiltration BMPs](#)). A site variability correction factor should be considered for native soils below permeable pavement.

As an alternative, walks, patios, and driveways with little storage capacity in the underlying aggregate base underdrain can be entered as lawn/landscape areas in the model. Suggested modeling approaches for various permeable pavement configurations are represented in [Table 6.5: Sizing Methods and Assumptions for Permeable Pavement](#).

**Screening Criteria**

The following screening criteria describe conditions that make permeable pavement infeasible or inefficient. If a project triggers any of the below-listed screening criteria, yet the proponent wishes to use permeable pavement, they may propose a functional design that effectively mitigates these issues to the local jurisdiction.

These criteria also apply to impervious pavements that would use stormwater collection from the surface of impervious pavement with redistribution below the pavement.

These screening criteria should be evaluated based on site-specific conditions by a licensed professional:

- Where professional geotechnical evaluation recommends infiltration not be used due to reasonable concerns about erosion, slope failure, or downgradient flooding.
- Within an area where ground water drains into an erosion hazard, or landslide hazard area.
- Where infiltrating and ponded water below new permeable pavement area would compromise adjacent impervious pavements.
- Where infiltrating water below a new permeable pavement area would threaten existing below grade basements.
- Where infiltrating water would threaten shoreline structures such as bulkheads.
- Downslope of steep, erosion-prone areas that are likely to deliver sediment.

- Where fill soils are used that can become unstable when saturated.
- On excessively steep slopes where water within the aggregate base layer or at the subgrade surface cannot be controlled by detention structures and may cause erosion and structural failure, or where surface runoff velocities may preclude adequate infiltration at the pavement surface.
- Where permeable pavements cannot provide sufficient strength to support heavy loads at industrial facilities such as ports.
- Where installation of permeable pavement would threaten the safety or reliability of preexisting underground utilities, preexisting underground storage tanks, or preexisting road subgrades.
- Within an area designated as an erosion hazard or landslide hazard.
- Within 50 feet of the top of slopes > 20%.
- For properties with known soil or ground water contamination (typically federal Superfund sites or state cleanup sites under the Model Toxics Control Act [MTCA]):
  - Within 100 feet of an area known to have deep soil contamination.
  - Where ground water modeling indicates infiltration will likely increase or change the direction of the migration of pollutants in the ground water.
  - Wherever surface soils have been found to be contaminated unless those soils are removed within 10 horizontal feet from the infiltration area.
  - In any area where these BMPs are prohibited by an approved cleanup plan under MTCA or the federal Superfund law or an environmental covenant under [Chapter 64.70 RCW](#).
- Within 100 feet of a closed or active landfill.
- Within 100 feet of a drinking water well, or a spring used for drinking water supply, if the pavement is a pollution-generating surface.
- Within 10 feet of a small on-site sewage disposal drain field, including reserve areas, and grey water reuse systems. For setbacks from a “large on-site sewage disposal system,” see [Chapter 246-272B WAC](#).
- Within 10 feet of any underground storage tank and connecting underground pipes, regardless of tank size. As used in these criteria, an underground storage tank means any tank used to store petroleum products, chemicals, or liquid hazardous wastes of which 10% or more of the storage volume (including volume in the connecting piping system) is beneath the ground surface.
- At multilevel parking garages and over culverts and bridges.
- Where the site design cannot avoid putting pavement in areas likely to have long-term excessive sediment deposition after construction (e.g., construction and landscaping material

yards).

- Where the site cannot reasonably be designed to have a porous asphalt surface < 5% slope, or a pervious concrete surface < 12% slope, or a permeable interlocking concrete pavement surface (where appropriate) < 12% slope. Grid systems upper slope limit can range from 6% to 12%; check with manufacturer and local supplier.
- Where the native soils below a pollution-generating permeable pavement (e.g., road or parking lot) do not meet the Site Suitability Criteria (SSC) for providing treatment.

**For more information:** See [SSC-6: Soil Physical and Chemical Suitability for Treatment](#).

**Note:** In these instances, the local jurisdiction has the option of requiring a 6-inch layer of media meeting the SSC or the sand filter specification as a condition of construction.

- Where seasonal high ground water or an underlying impermeable/low-permeability layer would create saturated conditions within 1 foot of the bottom of the lowest gravel base course.
- Where underlying soils are unsuitable for supporting traffic loads when saturated. Soils meeting a California Bearing Ratio of 5% are considered suitable for residential access roads.
- Where field testing indicates soils have a measured (e.g., initial) native soil saturated hydraulic conductivity < 0.3 in/hr.

**Note:** In these instances, unless other restrictions apply, roads and parking lots may be built with an underdrain, preferably elevated within the base course, if flow control benefits are desired.

- Where the road type is classified as arterial or collector rather than access. See [RCW 35.78.010](#), [RCW 36.86.070](#), and [RCW 47.05.021](#).

**Note:** This screening criterion does not extend to sidewalks and other non-traffic-bearing surfaces associated with the collector or arterial.

- Where replacing existing impervious surfaces unless the existing surface is a non-pollution-generating surface over an outwash soil with a saturated hydraulic conductivity of  $\geq 4$  in/hr.
- At sites defined as "[High-use sites](#)".
- In areas with "industrial activity" as identified in [40 CFR 122.26\(b\)\(14\)](#).
- Where the risk of concentrated pollutant spills is more likely such as gas stations, truck stops, and industrial chemical storage sites.
- Where routine, heavy applications of sand occur in frequent snow zones to maintain traction during weeks of snow and ice accumulation.

### **Common Component Design**

The following provides a description of the common components of permeable pavement systems. Design details for specific permeable pavement system components are included in the section [Types of Permeable Pavement](#).

## Contributing Area

Minimizing the amount of run-on from adjacent surfaces is preferred to prevent clogging and maximize the long-term performance of the pavement system. Introducing stormwater discharge from other impervious surfaces may be acceptable with careful consideration of the following minimum conditions:

- Sediment is not introduced to the pavement surface or subgrade.
- Additional flows do not exceed the long-term infiltration capability of the pavement surface or subgrade.

## Subgrade

In general, the requirement for subgrade strength beneath rigid pavement (pervious concrete) is less than for flexible pavements (porous asphalt). The structural performance of flexible permeable pavement systems relies on the proper design and construction of the aggregate base to provide structural support on subgrades with less compaction and increased soil moisture.

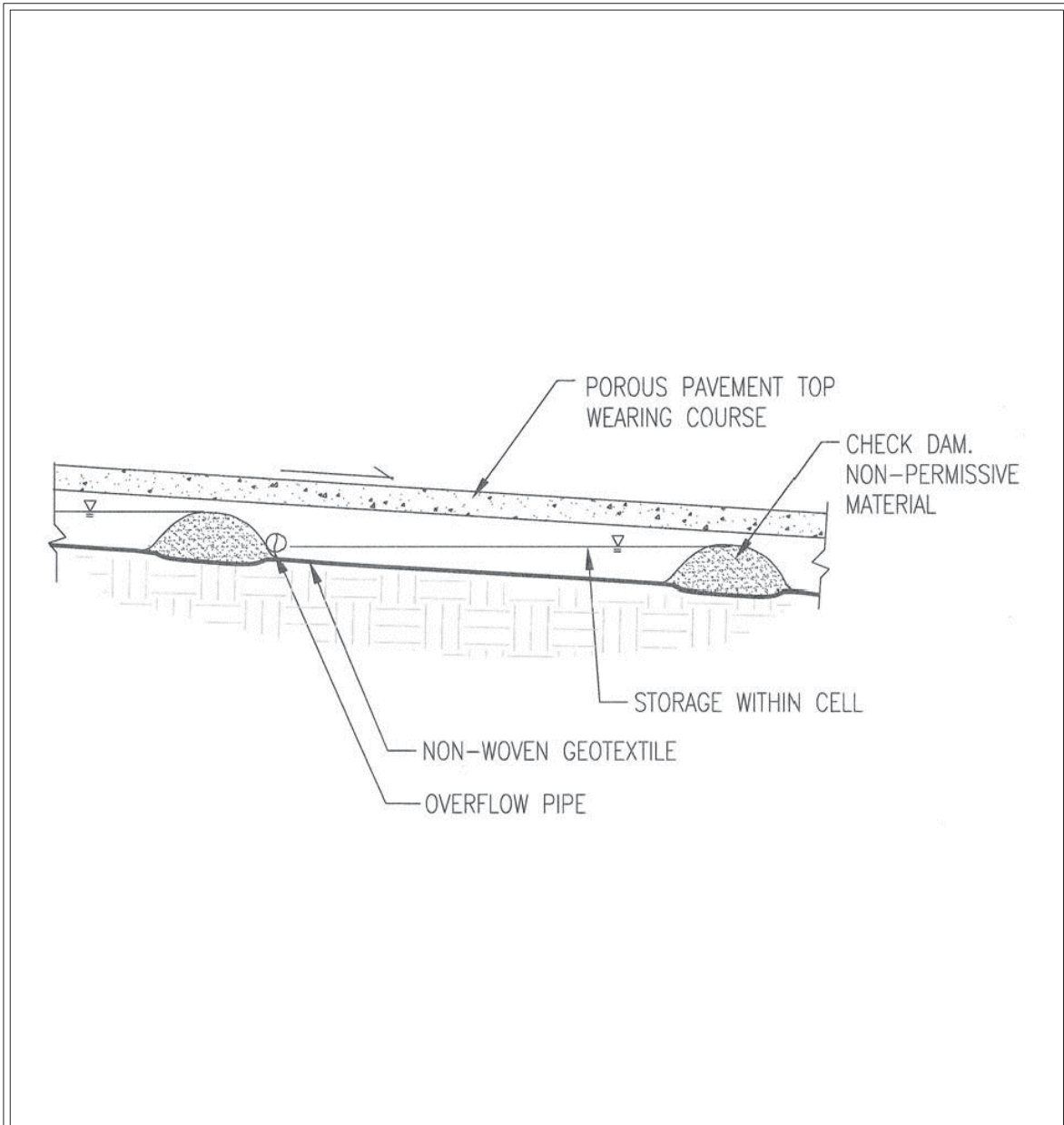
Two predominant guidelines are currently used for subgrade compaction of permeable pavement systems: firm and unyielding (qualitative) and 90% to 92% standard Proctor (quantitative). Consult with the local jurisdiction and a qualified professional for applicable guidelines. To properly prepare and maintain infiltration capacity and structural support on permeable pavement subgrades, a qualified professional should analyze soil conditions for infiltration capability at anticipated compaction and load-bearing capacity given anticipated soil moisture conditions.

## Subsurface Detention Structures

As permeable pavement subgrade slopes increase, storage and infiltration capacity decrease and flow velocities increase. To increase infiltration, improve flow attenuation, and reduce structural problems associated with subgrade erosion on slopes, use the following detention structures placed on the subgrade and below the pavement surface:

- Periodic impermeable check dams with an overflow drain invert placed at the maximum ponding depth. The distance between berms will vary depending on slope, flow control goals, and cost (see [Figure 6.25: Impermeable Check Dams on Permeable Pavement with Sloped Subgrade](#)).
- Gravel trenches with overflow drain invert placed at the maximum ponding depth. The distance between trenches will vary depending on slope, flow control goals, and cost.

**Figure 6.25: Impermeable Check Dams on Permeable Pavement with Sloped Subgrade**



Source: Low Impact Development Technical Guidance Manual for Puget Sound (WSU-PSP, 2012)



## Impermeable Check Dams on Permeable Pavement With Sloped Subgrade

Revised June 2013

Please see <http://www.ecy.wa.gov/copyright.html> for copyright notice including permissions, limitation of liability, and disclaimer.



## Storage Reservoir/Aggregate Base

The open-graded aggregate base provides the following:

1. A stable base that distributes vehicle loads from the pavement to the subgrade
2. A highly permeable layer to disperse water downward and laterally to the underlying soil
3. A temporary reservoir that stores water prior to infiltration into the underlying soil or collection in underdrains for conveyance ([WSDOT, 2003](#))

Aggregate base material is often composed of larger aggregate (1.5 to 2.5 inches). Smaller rock (leveling or choker course) may be used between the larger rock and the pavement depending on pavement type, working surface required to place the pavement, and base aggregate size (see sections below on specific pavement type and leveling or choker course guidelines). Typical void space in base layers range from 20% to 40% ([WSDOT, 2003](#)), ([Cahill et al., 2003](#)). Depending on the target flow control standard, ground water and underlying soil type, retention or detention requirements can be partially or entirely met in the aggregate base. Aggregate base depths of 6 to 36 inches are common depending on pavement type, structural design, storage needs, and environmental factors such as cold weather.

Flexible pavements (e.g., porous asphalt and permeable pavers) require properly designed aggregate base material for structural stability. Rigid pavements (pervious concrete) do not require an aggregate base for structural stability; however, a minimum depth of 6 inches is recommended for stormwater storage and providing a uniform surface for applying pervious concrete.

Increasing aggregate base depth for stormwater storage provides the additional benefit of increasing the strength of the overall pavement section by isolating underlying soil movement and imperfections that may otherwise be transmitted to the wearing course ([Cahill et al., 2003](#)). For more information on aggregate base material and structural support, see [Types of Permeable Pavement](#) for Aggregate Base recommendations by specific pavement type.

## Geotextile and Geogrids (Optional)

Geotextiles between the subgrade and aggregate base are not required or necessary for many soil types. However, for all permeable pavements, geotextile is recommended on the side slopes of the open graded base perimeter next to the soil subgrade if concrete curbs or impermeable liners are not provided that extend the full depth of the base/subbase. AASHTO M-288 ([AASHTO, 2011](#)) provides guidance for selection of geotextiles specifically for separation and drainage applications.

Geotextiles and geogrids are generally recommended for the following uses:

- As a filter layer to prevent clogging of infiltration surfaces
- For soil types with poor structural stability to prevent downward movement of the aggregate base into the subgrade (geotextiles or geogrids)

Clogging of the subgrade soil under permeable pavement systems could occur by fines from surface stormwater flow moving downward through the pavement section or from fines associated with the base aggregate washing off the rock and moving downward to the subgrade surface. Clogging of the base aggregate by the upward migration of fines into the aggregate has also been observed. The probability of clogging due to surface flow should be extremely low, given the current research

that shows accumulation of fines predominantly in the upper few centimeters of permeable pavement sections. Movement of fines from the aggregate base rock is likely if the aggregate base specification for the pavement system allows for excessive fines. The third process (upward movement of fines into the base aggregate) requires capillary tension for water (and sediment) to move upward into the base material. Base aggregate for permeable pavement systems are open graded (20% to 40% voids are common) which minimizes the capillary tension necessary for upward movement of materials ([WSU - PSP, 2012](#)).

Currently, the rate and subsequent risk of soil subgrade clogging from fines is not well understood. While permeable pavement surfaces trap sediment prior to entering the base and soil subgrade, there is no research or forensic exploration of existing permeable pavement projects demonstrating the extent of fines accumulating on soil subgrades ([WSU - PSP, 2012](#)).

For applications on fine-grained weak soil types, geotextile or geogrid may be necessary to minimize downward movement of base aggregate. Geotextiles provide tensile strength as the subgrade attempts to deform under load and the fabric is placed in tension, thereby improving load bearing of the pavement section ([Ferguson, 2005](#)).

### **Membrane Liners and Barriers**

Membrane liners on sidewalls of permeable pavement installations are recommended to:

- Reduce sidewall soil movement and degradation of subgrade infiltration capability; and
- Protect adjacent densely graded subgrade material from migrating into the more open graded aggregate base of the permeable pavement.

Polyvinyl chloride (PVC) membranes that are 30 millimeters are typical and should extend from the top of the aggregate base and 12 inches onto the bottom of the subgrade.

### **Underdrains (Optional)**

One or more underdrains may be installed at the bottom of a permeable pavement system if the infiltration capacity of the subgrade soil is not adequate to protect the following:

- The pavement and subgrade from freeze-thaw cycles
- The pavement wearing course from prolonged saturation that reduce infiltration capability
- Specific subgrade soil types from excessive periods of saturation that may lead to structural weakness

Underdrains without orifice or control structures will reduce infiltration to the subgrade and flow reduction which should be accounted for in hydrologic modeling for sizing purposes (see [Design Procedure](#)).

Consider including an orifice on underdrains. With an orifice, the permeable pavement installation will operate as an underground detention system. Recommendations for permeable pavement underdrains include the following:

- Underdrain flows should be conveyed to an approved discharge point.
- At a minimum, slotted or perforated, thick-walled plastic pipe with a minimum diameter of 6

inches should be used. Slots or perforations can be oriented up or down for installation.

- An appropriate cover depth and pipe material should be used that considers vehicle loads.
- To reduce clogging, the minimum orifice diameter should be 0.5 inches and maintenance activities should include regular inspection. Review local jurisdiction requirements for local minimum orifice diameter for belowground structures. In cold climates such as eastern Washington, consider using a larger minimum orifice diameter to reduce clogging due to ice formation.

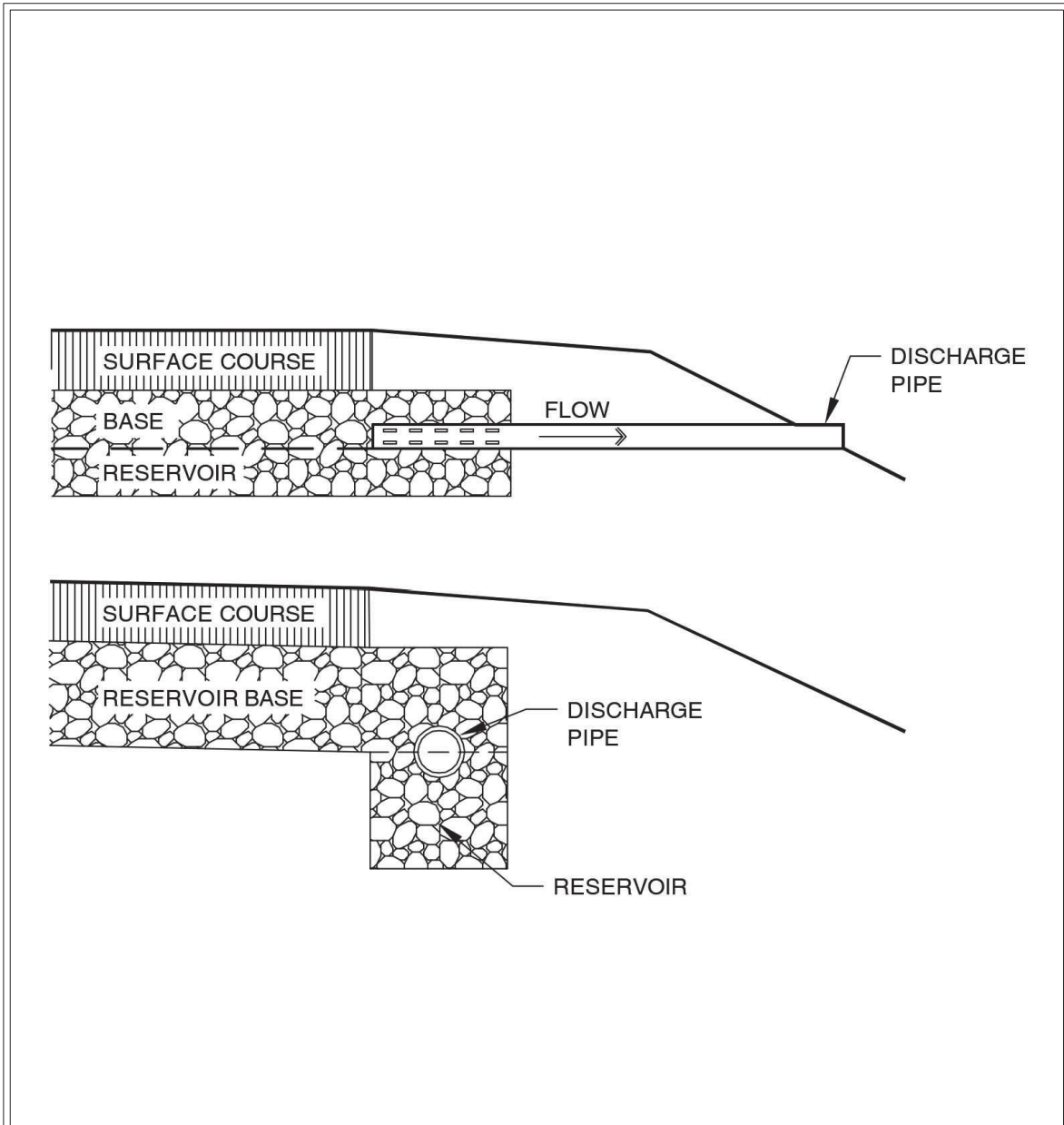
### **Elevated Drains (Optional Overflow)**

An overflow or elevated drain may be installed in the aggregate base of a permeable pavement system if the infiltration capacity of the subgrade soil is not adequate to protect the pavement wearing course from saturation. An elevated drain can also be used to create retention beneath the elevated drain invert if the subgrade analysis determines that the subgrade can provide adequate structural support, given the duration of saturated conditions. BMP overflow can be provided by subsurface slotted drain pipe(s) or by lateral flow through the storage reservoir to a surface or subsurface conveyance. Flows must be routed to an approved discharge point (see [Figure 6.26: Elevated Drain Designs for Permeable Pavement Aggregate Base/Reservoir](#)).

Recommendations for elevated drain design include the following:

- The maximum elevation of the overflow invert from the subgrade should drain water in the base aggregate before reaching the bottom of the permeable pavement wearing course and prevent saturation of the pavement.
- If site constraints necessitate an overflow pipe in an area subject to traffic or other loading, cover depth and pipe material should be designed to accommodate those loads.
- The pipe diameter and spacing for slotted overflow pipes will depend on the hydraulic capacity required. For a sloped subgrade, at least one overflow pipe should be installed at the downslope end of the BMP.
- Observation and clean-out ports should be used to determine whether the overflow is dewatering properly and allows access for back flushing.
- Overflows shall be designed to convey excess flow to approved discharge point.

**Figure 6.26: Elevated Drain Designs for Permeable Pavement Aggregate Base/Reservoir**



Source: Low Impact Development Technical Guidance Manual for Puget Sound (WSU-PSP, 2012)



## Elevated Drain Designs for Permeable Pavement Aggregate Base/Reservoir

Revised June 2013

Please see <http://www.ecy.wa.gov/copyright.html> for copyright notice including permissions, limitation of liability, and disclaimer.

## **Flow Entrance**

When designed to take runoff from other catchment areas, permeable pavement areas must be protected from sedimentation, which can cause clogging and degraded BMP performance. Acceptable flow entrance methods include sheet flow to the permeable pavement surface or subsurface delivery to the storage reservoir via pipes (e.g., for roof drainage). Accepted pretreatment for sediment removal (e.g., filter strip for surface flow and catch basin for subsurface delivery) should be included for any runoff to permeable pavement systems.

## **Backup Infiltration**

Backup infiltration can be designed into any permeable pavement system. Typical backup systems include aggregate areas along roads; parking lot medians and perimeters; and surface drains that are connected to the aggregate reservoir/base layer under the permeable pavement. The permeable pavement surface is then sloped gradually to the overflow or backup infiltration area (1% to 2% maximum slope recommended).

## **Wearing Course or Surface Layer**

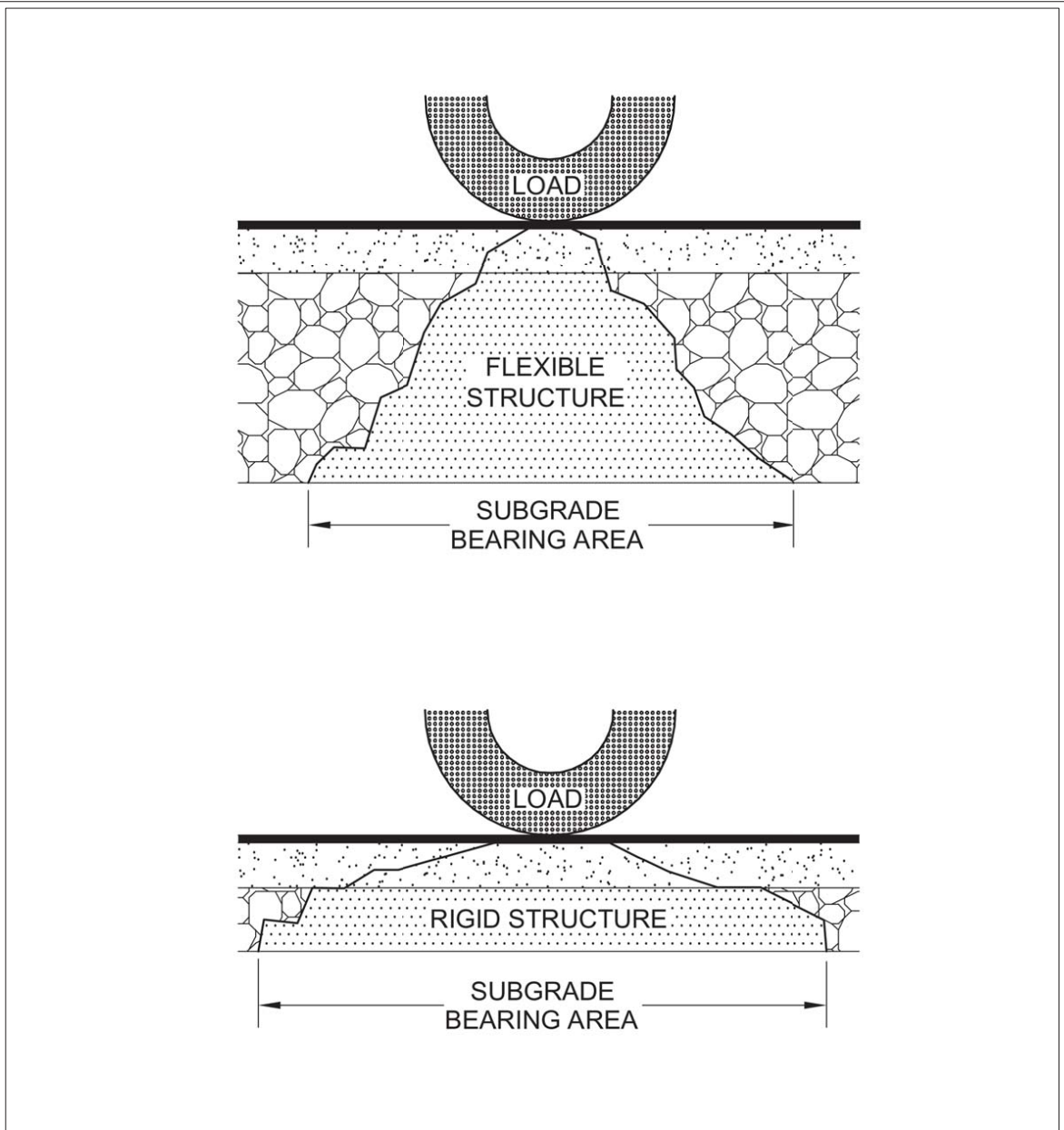
The wearing course provides support (in conjunction with the aggregate base) for the designed traffic loads while maintaining adequate porosity for storm flow infiltration. In general, permeable top courses have very high initial infiltration rates with various asphalt and concrete research reporting 28 to 1,750 in/hr when new. Various rates of clogging have been observed in wearing courses and should be anticipated and planned for in the system design. Permeable pavement systems allow infiltration of storm flows; however, to prevent freeze-thaw damage and retain infiltration capability, the wearing course should not become saturated from excessive water volume stored in the aggregate base layer.

## **Infiltration and Subgrade Structural Support**

Water, and particularly prolonged saturated conditions, can weaken most subgrade soils ([Ferguson, 2005](#)). For flexible permeable pavements, reduced compaction of the subgrade and the introduction of water to the subgrade can be compensated for by proper structural and hydrologic design, by selecting proper aggregate base materials, and increasing the aggregate base depth. A properly designed aggregate base 3 distributes vehicle load and subgrade bearing area (see [Figure 6.27: Conceptual Diagram of the Load Distribution Provided by Rigid \(Pervious Concrete\) and Flexible Permeable Pavements and the Aggregate Base](#)). The primary method for strengthening rigid pervious concrete is to increase the thickness of the pavement.

Increasing the aggregate base depth in permeable pavement systems provides the added benefit of increasing stormwater storage capacity, which can be particularly beneficial on subgrades with low permeability. Additionally, open graded rock may remain more stable in saturated conditions than densely graded road bases because the clean rock has less aggregate fines and, as a result, reduced pore pressures during saturated conditions ([Smith, 2011](#)). However, the same author also references several sources that indicate reduced structural capacity of open-graded bases compared to dense-graded bases under stresses from vehicle loads. Industry association literature should be referenced for determining base thicknesses for structural support.

**Figure 6.27: Conceptual Diagram of the Load Distribution Provided by Rigid (Pervious Concrete) and Flexible Permeable Pavements and the Aggregate Base**



Source: Low Impact Development Technical Guidance Manual for Puget Sound (WSU-PSP, 2012)

Revised June 2013



Conceptual Diagram of the Load Distribution  
Provided by Rigid (Pervious Concrete) and Flexible  
Permeable Pavements and the Aggregate Base

Please see <http://www.ecy.wa.gov/copyright.html> for copyright notice including permissions, limitation of liability, and disclaimer.

## **Determining Subgrade Infiltration Rates**

See [6.3.3 General Criteria for Infiltration BMPs](#) for details on determining infiltration rates for subgrade soils and consider the following for permeable pavement BMPs:

On commercial property parking lots and driveways, one small-scale pilot infiltration test (PIT) (see [Appendix 6-B: Guidelines for Site Characterization of Geotechnical Properties](#)) should be performed for every 5,000 square feet (sf) of permeable pavement, but not less than one test per site.

On residential developments, small-scale PITs should be performed for every 200 feet of roadway and at every proposed lot if the driveways are permeable pavement.

Tests at more than one site could reveal the advantages of one location over another. However, if the site subsurface, including soil borings across the development site, has consistent characteristics and depths to seasonal high ground water, the number of test locations may be reduced to a frequency recommended by a licensed engineer in the state of Washington with geotechnical expertise.

Ground water mounding analysis is not suggested for permeable pavement installations that do not receive stormwater run-on from adjacent impervious surface (i.e., the permeable pavement is infiltrated only by precipitation that falls directly on it).

## **Accessibility**

The permeable pavement systems examined in this section can be designed to meet Americans with Disabilities Act (ADA) requirements. Local, state and federal accessibility requirements can vary and designers should check with the permitting jurisdiction for accessibility related requirements.

The federal ADA design guidelines state that surfaces on accessible paths and travel routes should meet the following criteria:

- Firm, stable, and slip resistant
- Maximum openings that do not allow insertion of a 0.5-inch sphere

The International Building Code states that abrupt changes in height > 0.25 inches in accessible routes of travel shall be beveled to 1 vertical in 2 horizontal ([ICC, 2003](#)). Changes in level > 0.5 inches shall be accomplished with an approved ramp. Porous asphalt and pervious concrete, while rougher than conventional paving, do not have abrupt changes in level when properly installed. Concrete pavers have small openings or joints when properly installed and most concrete paver surfaces create smooth surfaces that meet ADA design guidelines. Consult with the paver supplier to confirm its product meets ADA requirements. Plastic and concrete grid systems use a specific aggregate with a reinforcing grid that creates a firm and relatively smooth surface.

Two qualifications for use of permeable pavement and designing for ADA should be noted. Sidewalk designs incorporate scoring, or more recently truncated domes, near the curb ramp to indicate an approaching traffic area for the blind. The rougher surfaces of permeable pavement may obscure this transition; accordingly, standard concrete with scoring or truncated domes should be used for curb ramps ([FCPA, n.d.](#)). Also, the aggregate within the cells of permeable pavers (such as Eco-

Stone) can settle or be displaced from vehicle use. As a result, paver installations for ADA parking spaces and walkways may need to include pavers with smaller permeable joints or pavers constructed with permeable material and tight joints. Individual project designs should be assessed by site characteristics and regulatory requirements of the jurisdiction.

### **Types of Permeable Pavement**

The following section provides design guidelines for porous asphalt, pervious concrete, a permeable interlocking concrete pavement, and a plastic grid system. Each product has specific design requirements and each site has unique characteristics and development requirements. Accordingly, qualified professionals, as well as association and manufacturer specifications, should be consulted for developing specific permeable pavement systems.

### **Porous Hot-Mix Asphalt**

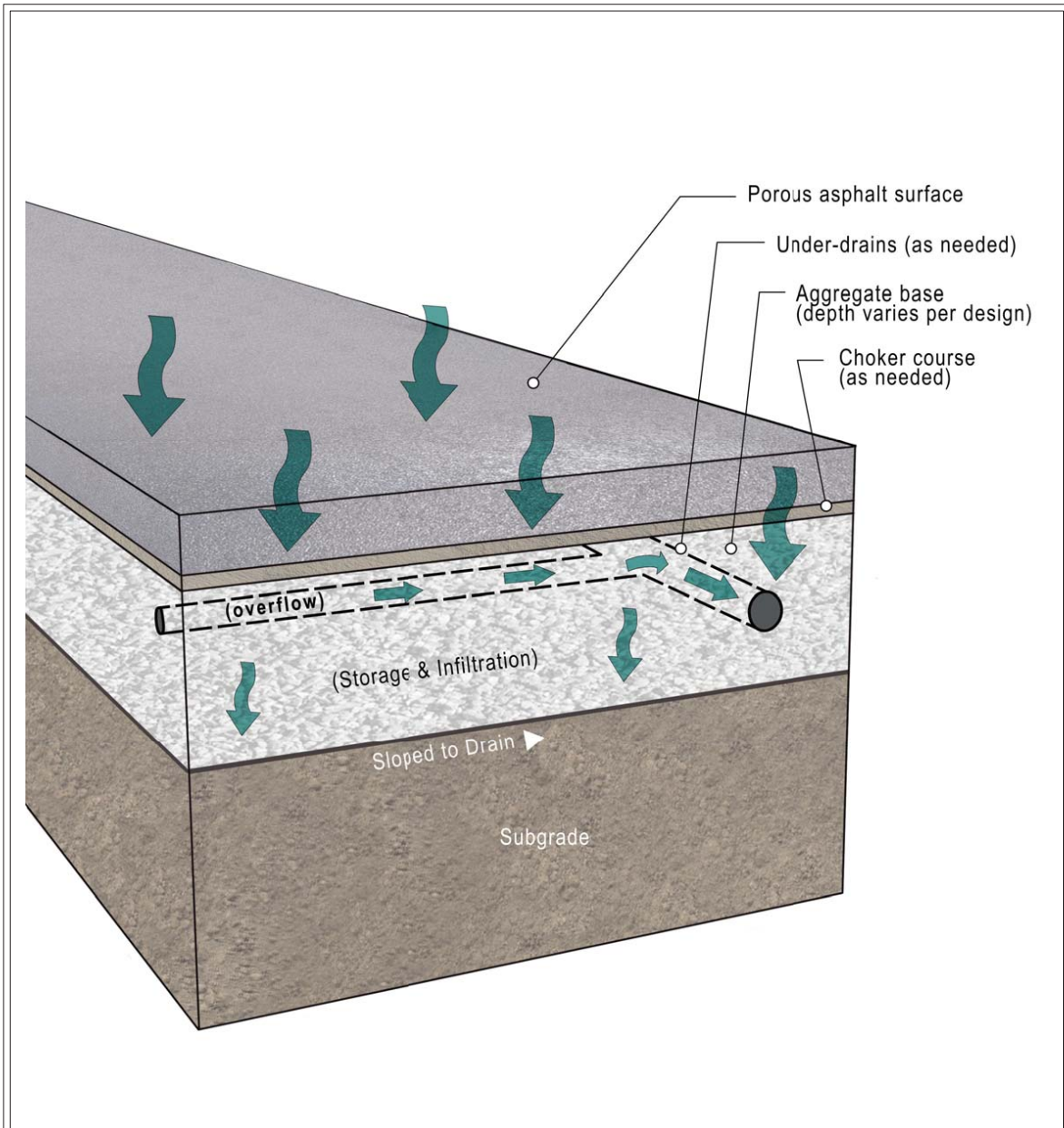
Porous hot or warm-mix asphalt is similar to standard hot or warm-mix asphalt; however, the aggregate fines (particles smaller than No. 30 sieve) are reduced, leaving a matrix of pores that conduct water to the underlying aggregate base and soil ([Cahill et al., 2003](#)). Porous asphalt is commonly used for light- to medium-duty applications, including residential access roads, driveways, utility access, parking lots, and walkways; however, porous asphalt has been used for heavy applications, such as airport runways (with the appropriate polymer additive to increase bonding strength), auto storage at ports, and highways ([Hossain et al., 1992](#)). Properly installed and maintained porous asphalt should have a structural service life that is comparable or longer than conventional asphalt ([WSU - PSP, 2012](#)).

Early applications of porous asphalt were subject to fairly rapid decline of infiltration rates and surface raveling. The primary cause of these problems was inadequate binder strength and associated drain-down of the binder from higher to lower elevation in the pavement. As a result, the binder coating and cohesion between the surface aggregate are reduced and the aggregate becomes dislodged by vehicle wear. The additional binder moving downward in the pavement then collects just below the asphalt surface as it thickens from entrained particles lodged in the pores and as temperatures decline from the surface. The additional binder forms a layer that clogs the porous asphalt pores and reduces infiltration.

The following subsections provide specifications and installation procedures for porous asphalt applications in which the wearing top course is entirely porous, the base course accepts water infiltrated through the top course, and the primary design objective is to significantly or entirely attenuate storm flows. A schematic of a typical porous asphalt section is provided in [Figure 6.28: Typical Porous Asphalt Section](#).



**Figure 6.28: Typical Porous Asphalt Section**



Source: CleanWater Services and AHBL, Inc.



## Typical Porous Asphalt Section

Revised June 2013

Please see <http://www.ecy.wa.gov/copyright.html> for copyright notice including permissions, limitation of liability, and disclaimer.

## Applications

Applications include but are not limited to parking lots, residential access and collector roads, light arterial roads, pedestrian and bike paths, and utility access.

## Soil Infiltration Rate

Surface flows directed from adjacent areas to the pavement surface or subgrade can introduce excess sediment, increase clogging, result in excessive hydrologic loading, and should only be considered with particular attention to sediment control, infiltration capacity of the subgrade, and adequate maintenance.

**For more information:** See [6.3.3 General Criteria for Infiltration BMPs](#) for guidelines on determining subsurface infiltration rates.

## Subgrade

See [Installation Guidelines](#) for construction techniques to reduce compaction.

## Underdrain

See [Common Component Design](#) for underdrain design guidelines for permeable pavement systems.

## Aggregate Base/Storage Bed Material

- Minimum base depth for structural support should be based on hydrologic modeling to determine storage capacity needed and structural pavement design consideration.
- Maximum depth is determined by the extent to which the designer intends to achieve a flow control standard with the use of a below-grade storage bed. Aggregate base depths of 12 to 24 inches are common depending on storage needs.
- Several aggregate gradations can be used for a porous asphalt base. For a successful installation, the aggregate should:
  - Have adequate voids for water storage (20% to 40% voids is typical);
  - Be clean and have minimal fines (0% to 2% passing the No. 200 sieve maximum); and
  - Be angular and have adequate fractured face to lock together and provide structural support (70% minimum and 90% preferred for fractured face).
- Two example aggregate guidelines are as follows:
  - WSDOT Permeable Ballast (9-03.9(2) 0.75 to 2.5 inches) with a 1- to 2-inch-deep choker course consisting of the same aggregate gradation that is used for the pavement wearing course (see [Aggregate Gradation](#)).
  - A 0.75- to 1.5-inch clean, coarse crushed rock aggregate with 0% to 2% passing the No. 200 sieve. This gradation provides a uniform working surface and does not require a choker course. However, additional attention during installation of the pavement is required (see [Construction Criteria](#) and [Installation Guidelines](#)).

## Pavement or Wearing Course Materials

Material availability may vary regionally, and mix design may vary for the materials. The following

references for mix design may be appropriate for design in eastern Washington:

- Porous Asphalt Pavements for Stormwater Management (NAPA, 2008)
- Latest version of the Stormwater Management Manual for Western Washington (SWMMWW)
- Latest version of the WSDOT General Special Provisions (GSPs) for Porous Hot Mix Asphalt (PHMA), Porous Warm Mix Asphalt (PWMA)

Example aggregate gradation and bituminous asphalt cement guidelines that have been used successfully in the Puget Sound region are provided below and in the SWMMWW.

### Thickness

- Porous asphalt has a slightly lower structural contribution than conventional asphalt. Follow [\(NAPA, 2008\)](#) for the structural contribution and recommended asphalt pavement thicknesses.
- Parking lots: 2 to 4 inches typical, 3 inches minimum recommended.
- Residential access roads and arterials: 4 to 6 inches typical.

### Aggregate Gradation

U.S. Standard Sieve	Percent Passing
3/4 inch	100
1/2 inch	90 to 100
3/8 inch	70 to 90
No. 4	20 to 40
No. 8	10 to 20
No. 40	7 to 13
No. 200	0 to 3

A small percentage of fine aggregate is necessary to stabilize the larger porous aggregate fraction. The finer fraction also increases the viscosity of the asphalt cement and controls asphalt drainage characteristics.

### Bituminous Asphalt Cement

- **Content:** 6.0% to 6.5% by weight of total (dry aggregate) mix. Performance Grade (PG) 70-22. Do not use an asphalt cement performance grade less than PG 70-22 for open graded, porous asphalt mixes.

**Note:** Supplies of PG 70-22 may be limited in the winter season.

- **Drain-down:** 0.3% maximum according to ASTM D6390-11.
- An elastomeric polymer can be added to the bituminous asphalt cement to reduce drain-down.

Note: PG 70-22 and stiffer PG grades usually contain an elastomeric polymer.

- Fibers can be added and may prevent drain-down.
- **Antistripping agent:** As water moves through the porous asphalt pavement, the asphalt emulsion contact with water increases compared to conventional impervious asphalt. An antistripping agent reduces the erosion of asphalt binder from the mineral aggregate and is, therefore, recommended for porous asphalt. A qualified products list of antistripping additives is available in the latest version of the WSDOT Standard Specifications. Use an approved test for antistripping such as AASHTO T 283-07, Standard Method of Test for Resistance of Compacted Asphalt Mixtures to Moisture-Induced Damage or the Hamburg test.
- Total void space should be approximately 16% to 25% per ASTM D3203/D3203M-11 (conventional asphalt is 2% to 3%).

### **Backup Systems for Protecting Porous Asphalt Systems**

See [Common Component Design](#) for backup or overflow guidelines and [Construction Criteria](#) for construction techniques.

### **Portland Cement Pervious Concrete**

Pervious Portland cement concrete is similar to conventional concrete with reduced or no fine aggregate (sand). The mixture is a washed crushed or round coarse aggregate (typically 3/8- or 1/4-inch), hydraulic cement, admixtures (optional), and water. The combination of materials form an agglomeration of coarse aggregate surrounded and connected by a thin layer of hardened cement paste at the points of contact. When hardened, the pavement produces interconnected voids that conduct water to the underlying aggregate base and soil. Pervious concrete can be used for various light to heavy-duty applications supporting low to moderate speeds. Properly installed and maintained concrete should have a structural life comparable to conventional concrete (American Concrete Institute [ACI] 522.1-08).

Pervious concrete pavement is a rigid system and does not rely to the same degree as flexible pavement systems on the aggregate base for structural support. Designing the aggregate base will depend on several factors, including project-specific flow control objectives (retention or detention storage), costs, and regulatory restrictions. As with other permeable pavement systems, deeper aggregate base courses (e.g., 12 to 24 inches) can provide important benefits including significant reduction of aboveground stormwater retention or detention needs and uniform and improved subgrade support ([FCPA, n.d.](#)). See [Design Procedure](#) for more information on flow modeling guidance.

The following subsections provide design guidelines that apply broadly to pervious concrete pavements. Pavements should be designed by licensed professionals with geotechnical and traffic data for the particular site. Industry standards, materials, and methods specific to pervious concrete should be followed. Over the past several years, pervious concrete mixes that include proprietary additives have been developed with varying degrees of success. The following subsections describe a standard concrete mix design characterized by washed coarse aggregate (e.g., 1/4- or 3/8-inch), hydraulic cement, admixtures (optional), and water with no proprietary ingredients.

ACI 522.1-08 is the current national standard for specification of pervious concrete pavement. This manual defers to the current version of ACI 522.1-08 for developing pervious concrete pavement

specifications. Included below are specific sections of ACI 522.1-08 relevant to this manual and additional guidelines for infiltration rates, subgrade preparation, and aggregate base placement specific to eastern Washington and developed from national and local experience.

**For more information:** The Construction Materials Committee of the American Public Works Association (APWA) Washington has also developed a set of pervious concrete (PConcrete) specifications, which can be found in the latest version of the WSDOT GSPs.

## Applications

Applications for pervious concrete include parking lots, driveways, sidewalks, trails, promenades, utility access, commercial parking, and residential roads.

## Soil Infiltration Rate

- See [6.3.3 General Criteria for Infiltration BMPs](#) for guidelines on determining subsurface infiltration rates.
- Soils with lower infiltration rates (e.g., < 0.3 in/hr) may require underdrains or elevated drains to prevent periodic saturated conditions within 6 inches of the bottom of the aggregate base (interface of the subgrade and aggregate base).
- Surface flows directed from adjacent areas to the pavement surface or subgrade can introduce excess sediment, increase clogging, and result in excessive hydrologic loading; therefore, special attention should be paid to sediment control and infiltration capacity of the subgrade, and adequate maintenance.
- On extremely poor soils with low strength and very low infiltration rates, use an impermeable liner with underdrains.

## Subgrade

See [Installation Guidelines](#) for construction techniques to reduce compaction.

## Underdrain

See [Common Component Design](#) for underdrain design guidelines.

## Aggregate Base/Storage Bed Materials

- The minimum base depth should be based on structural design consideration.
- Maximum depth is determined by the extent to which the designer intends to achieve a flow control standard with the use of a below-grade storage bed. Aggregate base depths of 6 to 18 inches are common when designing for retention or detention.
- The coarse aggregate layer varies depending on structural and stormwater management needs. Typical placements are crushed washed aggregate and include WSDOT Permeable Ballast (0.75 to 2.5 inches). Do not use round rock where perimeter of the base aggregate is not confined (e.g., sidewalk placed above grade). Round rock will easily move or roll from the perimeter of the aggregate base, creating weak voids with no structural support for the pavement.
- The concrete can be placed directly over the coarse aggregate or an open graded leveling course (e.g., 1/2-inch to U.S. sieve size No. 8 or AASHTO No. 57 crushed washed rock), which

may be placed over the larger rock for final grading to provide a more stable, uniform working surface and reduce variation in thickness.

### **Pavement Materials**

The following guidelines provide typical ranges of materials for pervious concrete. Proper mix design and the resulting performance of the finished product depends on the specific aggregate used and proper cement content and water-cement ratios determined by that aggregate. Consult the qualified concrete supplier, local jurisdiction specifications, and ACI 522.1-08 for developing final mix design.

### **Pavement Thickness**

- Parking lots: 5 to 9 inches typical
- Roads: 6 to 12 inches typical

### **Unit Weights**

Typical unit weight is 120 to 135 pounds per cubic foot (cf)  $\pm$  5%. Pervious concrete is approximately 70% to 80% of the unit weight of conventional concrete) (FCPA, n.d.).

### **Void Content**

Per ASTM C138/C13813-M, 18 to 20%  $\pm$  3% to 5% are typical (interconnectivity of voids and, therefore, infiltration rates are inadequate < 15%) (ACI 522.1-08). Void content is measured indirectly by determining fresh (wet) concrete density using ASTM C138/C13813-M or ASTM C1688/CC168813-M and is a secondary measure reflecting strength and permeability of the hardened concrete. Acceptable permeability, strength, and appearance are primarily determined by the test panel (see [Quality Control, Testing and Verification](#)), which in part includes comparing unit weights of the accepted test panel cores and finished work cores.

### **Water-to-Cement Ratio**

- Water-to-cement ratio of 0.26 to 0.45 provides the optimum aggregate coating and paste stability.
- Water content is a critical design element of pervious concrete.
  - If too dry, cohesiveness and cement hydration efficiency may be reduced.
  - If too wet, the cement paste may drain down and result in a weak upper structure and clog the lower portion of the pavement (ACI 522.1-08).

### **Total Cementitious Material Content**

- Total cementitious content will range from 470 to 564 pounds per cubic yard.
  - Content should be determined by the supplier and identified in the mix design submittal.
  - The optimum content is entirely dependent on aggregate size, void content, and gradation (ACI 522.1-08).

### **Aggregate**

- Gradations are typically either single-sized coarse aggregate or gradations between 3/4- and 3/8-inch.

- In general, the 1/4-inch crushed or round produces a slightly smoother surface than coarser aggregate.
- Aggregate should meet requirements of ASTM D448-12 and C33/C33M-12.
- Aggregate moisture at mixing is important to produce adequate workability and prevents draining of paste (ACI 522.1-08).

## Portland Cement

- Type I or II conforming to ASTM C150/C150M-12, C595/C595M-13 or C1157/C1157M-11.
- Supplementary cementitious materials such as fly ash, ground blast furnace slag, and silica fume can be added to Portland cement.
- Testing material compatibility is strongly recommended (ACI 522.1-08).

## Admixtures

- Water reducing/retarding, viscosity modifiers and hydration stabilizers can be used to increase working time and improve the workability of the pervious concrete mix.
- Use potable water.
- Fibers may add strength and permeability to the placed concrete, are recommended, and can be used as an integral component of the concrete mix.

## Backup Systems for Protecting Pervious Concrete Systems

See [Common Component Design](#) for backup or overflow guidelines and [Construction Criteria](#) for construction techniques.

## Permeable Interlocking Concrete Pavers

Permeable interlocking concrete pavers (PICPs) are 1/8 inches thick for vehicular applications, and pedestrian areas may use units that are 2 3/8 inches thick (Smith, 2011). When compacted, the pavers interlock and transfer vertical loads to surrounding pavers by shear forces through aggregate in the joints ([Pentec Environmental, 2000](#)). Interlocking pavers are placed on open graded subbase aggregate topped with a finer aggregate layer that provides a level and uniform bedding material. Properly installed and maintained, high-density pavers have high load bearing strength and are capable of carrying heavy vehicle weight at low speeds. Properly installed and maintained pavers should have a service life of up to 40 years ([Smith, 2011](#)).

The Interlocking Concrete Pavement Institute (ICPI) provides technical information on best practices for PICP design, specification, construction, and maintenance. Manufacturers or suppliers of particular pavers should be consulted for materials and guidelines specific to that product. Experienced contractors with a certificate from the ICPI PICP Installer Program should perform installations. This requirement should be included in project specifications. The following design guidelines apply broadly to permeable interlocking concrete pavers.

## Applications

Industrial and commercial parking lots, industrial sites that do not receive hazardous materials, utility access, low speed (< 40 mph) residential access roads, driveways, patios, promenades, and walkways.

## Soil Infiltration Rate

- See [6.3 Infiltration BMPs](#) for guidelines on determining subsurface infiltration rates.
- Surface flows directed from adjacent areas to the pavement subgrade can introduce excess sediment, increase clogging, result in excessive hydrologic loading, and special attention should be paid to sediment control, infiltration capacity of the subgrade.

## Subgrade

- Open graded subbase: No. 2 rock.
- Open graded base: No. 57 rock.
- Bedding course: No. 8 rock, typically.
- Soils should be analyzed by a qualified professional for infiltration rates and load bearing, given anticipated soil moisture conditions.
- The ICPI recommends a minimum California Bearing Ratio (CBR) of 4% (96-hour soak per ASTM D1883-07e2 or AASHTO T 193) to qualify for use under vehicular traffic applications ([Smith, 2011](#)).

**For more information:** See [Installation Guidelines](#) for construction techniques to reduce compaction.

## Underdrain

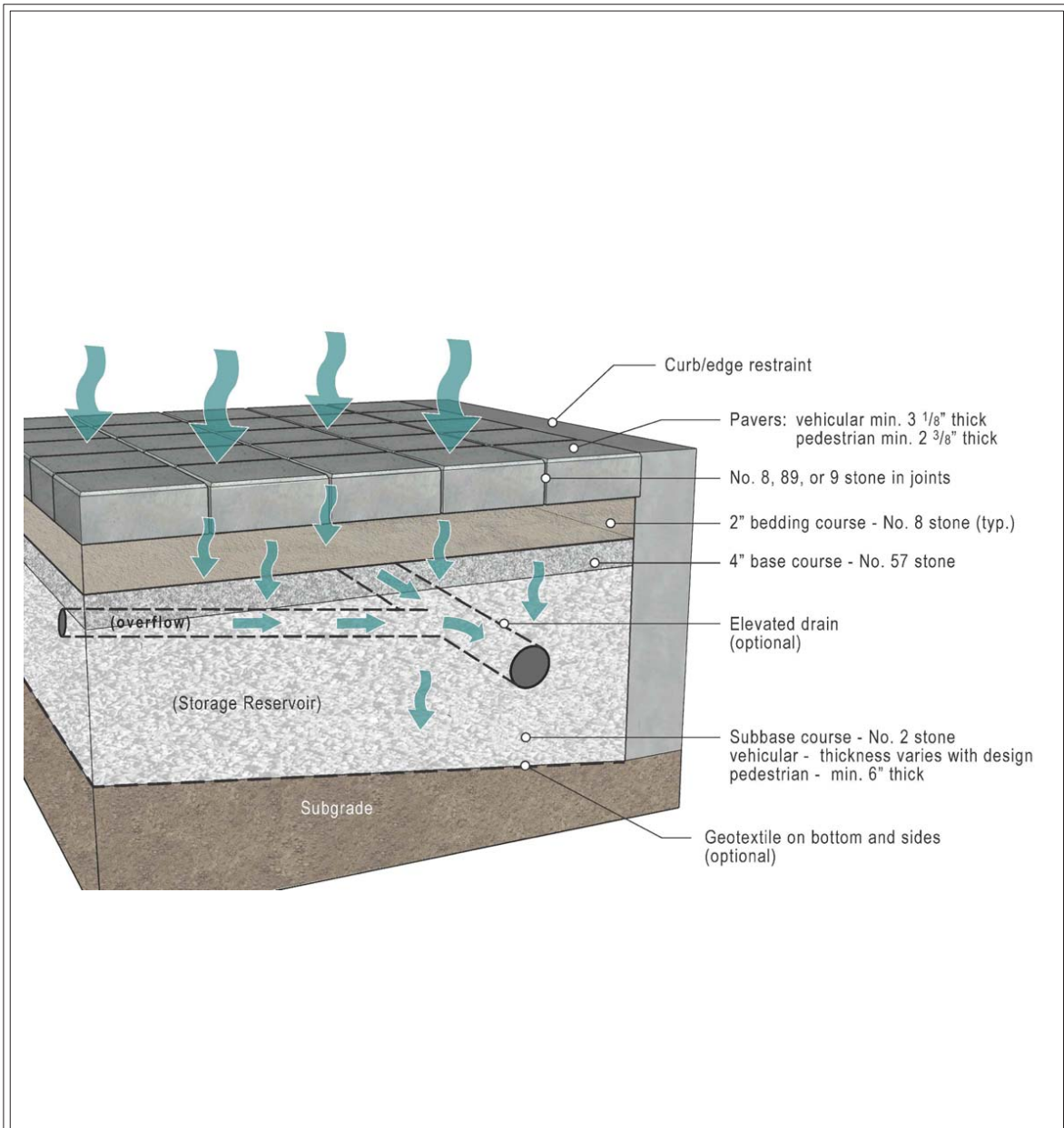
See [Common Component Design](#) for underdrain design guidelines.

## Aggregate Base/Storage Bed Materials

- Minimum subbase thickness depends on vehicle loads, soil type, stormwater storage requirements, and freeze-thaw conditions. Typical subbase depths range from 6 to 24 inches. ICPI recommends base/subbase thicknesses for pavements up to a lifetime of 1 million equivalent single-axle loads (ESALs) that are 18,000 pounds each. For example, at lifetime ESALs of 500,000 with a CBR of 5%, the subbase (ASTM No. 2 rock) should be 18 inches, and the base (ASTM No. 57 rock) thickness should be 4 inches. Increased aggregate subbase thicknesses can be applied for increased stormwater volume storage. See ICPI guidelines for details on base thickness and design (Smith, 2011).
- Minimum subbase depth for pedestrian applications should be 6 inches ([Smith, 2011](#)).
- See [Figure 6.29: Typical Permeable Interlocking Concrete Paver Section](#) for aggregate subbase, base, bedding coarse, and paver materials.
- The subbase and base aggregate should be hard, durable, crushed rock with 90% fractured faces, a Los Angeles (LA) Abrasion of < 40 (ASTM C131-06 and C535-12) and a design CBR of 80% ([Smith, 2011](#)).



**Figure 6.29: Typical Permeable Interlocking Concrete Paver Section**



Source: CleanWater Services and AHBL, Inc.



## Typical Permeable Interlocking Concrete Paver Section

Revised June 2013

Please see <http://www.ecy.wa.gov/copyright.html> for copyright notice including permissions, limitation of liability, and disclaimer.

## Edge Restraints

The type of edge restraint depends on whether the application is for pedestrian, residential driveways or vehicle use. For installations intended for vehicles, use a cast-in-place curb (typically 9 inches deep) that rests on the top of the subbase, or one that extends the full depth of the base and subbase. If the paver installation is adjacent to existing impervious pavement, the curb should extend to the full depth of pavement and aggregate base to protect the impervious installation base from excessive moisture and weakening. If the concrete curb does not extend the full depth an impermeable liner can be used to separate the two base materials ([Smith, 2011](#)).

Cast-in-place concrete curbs or dense-graded berms to provide a base to secure spiked metal or plastic edge restraints can be used for pedestrian and residential driveway applications. An additional option for pedestrian and light parking application is a subsurface concrete grade beam with pavers cemented to the concrete beam to create a rigid paver border.

## Backup Systems for Protecting PICP Systems

See [Common Component Design](#) for backup or overflow guidelines and [Construction Criteria](#) for construction techniques.

## Plastic or Concrete Grid Systems

Plastic or concrete grid systems come in several configurations. The goal for all plastic grid systems is to create a stable, uniform surface to prevent compaction of the gravel or soil and grass fill material that creates the finished surface. Of all the permeable pavement systems, grid systems have the largest void space available for infiltration in relation to the solid support structure.

Flexible grid systems conform to the grade of the aggregate base, and when backfilled with appropriate aggregate top course, provide high load bearing capable of supporting fire, safety, and utility vehicles. These systems, when properly installed and maintained, are not impacted by freeze-thaw conditions found in eastern Washington and have an expected service life of approximately 25 years ([Bohnhoff, 2001](#)).

## Applications

Typical uses include alleys, driveways, utility access, loading areas, trails, and parking lots with relatively low traffic speeds (15 to 20 mph maximum).

## Subgrade

See [Installation Guidelines](#) for construction techniques to reduce compaction.

## Underdrain

See [Common Component Design](#) for underdrain design guidelines.

## Aggregate Base/Storage Bed Materials

Minimum base thickness depends on vehicle loads, soil type, and stormwater storage requirements. Typical minimum depth is 4 to 6 inches for driveways, alleys, and parking lots (less base course depth is required for trails) (personal communication between C. Hinman and A. Gersen, 2004). Increased depths can be applied for additional storage capacity if needed to meet flow control goals.

Typical base aggregate is a sandy gravel material typical for road base construction.

Example aggregate grading:

U.S. Standard Sieve	Percent Passing
1 inch	100
3/4 inch	90 to 100
3/8 inch	70 to 80
No. 4	55 to 70
No. 10	45 to 55
No. 40	25 to 35
No. 200	3 to 8

### *Aggregate Fill for Aggregate Systems*

Aggregate should be clean, washed, and hard angular rock typically 3/16- to 1/2-inch.

### *Aggregate Fill for Grass Systems*

- For plastic grids, sand (usually with a soil polymer or conditioner), sandy loam or loamy sand are typical fill materials.
- For concrete grids, fill the openings with topsoil.

## **Backup Systems for Protecting Grid Systems**

See [Common Component Design](#) for backup or overflow guidelines and [Construction Criteria](#) for construction techniques.

## **Construction Criteria**

Installation procedures for permeable pavement systems are different from conventional pavement. For successful application of any permeable pavement system, the following guidelines should be followed:

### **Qualified Manufacturers, Installation Contractors, and Suppliers**

Material manufacturers must have experience with producing proper mix designs for pervious concrete or porous asphalt and make materials that comply to national standards. Permeable interlocking concrete pavement and other factory produced materials should conform to national product standards. Installation contractors must be adequately trained, have substantial and successful experience with the pavement product, and adhere to material specifications for proprietary systems. Installation contractors should provide information showing successful application of permeable pavements for past projects and recommended certification, if available, for the specific type of permeable pavement. Suppliers must have experience with producing proper mix designs for pervious Portland cement concrete or porous hot-mix asphalt. Substituting inappropriate materials or installation techniques will likely result in structural or hydrologic performance problems or failures.

### **Sediment and Erosion Control During Construction and Long-Term**

Erosion and introduction of sediment from surrounding land uses should be strictly controlled during and after construction to reduce clogging of the void spaces in the subgrade, base material, and permeable surface. Muddy construction equipment should not be allowed on the base material or pavement, sediment laden runoff should be directed to treatment areas (e.g., settling ponds and swales), and exposed soil should be mulched, planted, and otherwise stabilized as soon as possible. Construction sequencing for proper installation and minimizing erosion and sediment inputs is critical for project success. Long-term O&M manuals that consider the physical setting, timing, and equipment needs should be developed during the design phase.

Poor quality installations are most often attributed to not following guidelines, structural or flow management problems, or failures are likely without qualified contractors and correct application of specifications.

### **Installation Guidelines**

This section provides general installation guidelines for the subgrade, storage reservoir/aggregate base, and geotextiles (optional) for all types of permeable pavements. Following the general guidance, specific installation guidelines for porous asphalt, pervious concrete, PICP, and grid systems are provided.

### **Subgrade**

Careful attention to subgrade preparation during installation is required to balance the needs for structural support while maintaining infiltration capacity. For all permeable pavements, relative uniformity of subgrade conditions is necessary to prevent differential settling or other stress across the system.

On sites where the topsoil is removed and native subsoil exposed, no compaction may be required for adequate structural support while protection of the subgrade from compaction is necessary to retain infiltration capacity. For applications with heavy truck traffic, some soil subgrade compaction may be necessary for structural support. The effect of compaction on subgrade permeability will vary significantly depending on soil type. For example, the permeability of a coarser textured sand may be affected minimally while the permeability of finer textured soils will likely be significantly degraded for a given compaction effort. Effects of compaction on soil permeability can be assessed by conducting laboratory Proctor density tests on subgrade soils from the proposed permeable pavement site. Soils in test areas can be compacted to various density levels through field measurements and the resulting permeability measured using ASTM test methods.

**For more information:** See [Appendix 6-B: Guidelines for Site Characterization of Geotechnical Properties](#) for more detail on test procedures.

To properly prepare and maintain infiltration capacity and structural support on permeable pavement subgrades, use the following procedures:

- During and after grading, excessive construction equipment or material stockpiling should not be compacted more than the recommended compaction value. The following guidelines should be used to prevent excessive compaction and maintain infiltration capacity of the subgrade:
  - Final grading should be completed by machinery operating on a preliminary subgrade that is  $\geq 12$  inches higher than final grade or structures to distribute equipment load

(e.g., steel plates or aggregate base material). Final excavation then proceeds as machinery is pulling back and traveling on preliminary grade as final grade is excavated.

- To prevent compaction when installing the aggregate base, the following steps (back-dumping) should be followed:
  1. The aggregate base is dumped onto the subgrade from the edge of the installation and aggregate is then pushed out onto the subgrade.
  2. Trucks dump subsequent loads from on top of the aggregate base as the installation progresses.
- Avoid subgrade preparation during wet periods (soil compaction increases significantly if soil is wet).
- If machinery must access the final grade, limit the access to a specific travel way that can be tilled before application of the base aggregate or place heavy steel plates on subgrade and limit traffic to the protective cover.

**Note:** Allowing heavy machinery on permeable pavement subgrades during wet or saturated conditions will result in deep compaction (often 3 feet) and cannot be compensated for by shallow tilling or ripping soil ([Balousek, 2003](#)).

- If using the pavement system for retention in parking areas, excavate the subgrade level to allow even distribution of water through the aggregate base and maximize infiltration across the entire parking area ([Cahill et al., 2003](#)).
- Immediately before placing base aggregate and pavement, remove any accumulation of fine material (if present) with light equipment and scarify soil to a minimum depth of 6 inches to prevent sealing of the subgrade surface.
- Excavate the subgrade with level steps. The step length will vary depending on slope, flow control goals, and cost. Excavating level steps is most applicable for parking lots where the pavement surface is also stepped. While the subgrade is excavated level, the pavement surface should maintain a minimal slope of 1% to 2%.

## **Storage Reservoir/Aggregate Base**

The open-graded aggregate base provides the following:

1. A stable base that distributes vehicle loads from the pavement to the subgrade
2. A highly permeable layer to disperse water downward and laterally to the underlying soil
3. A temporary reservoir that stores water prior to infiltration into the underlying soil or collection in underdrains for conveyance ([WSDOT, 2003](#))

Aggregate base material is often composed of larger aggregate (1.5 to 2.5 inches). Smaller rock (leveling or choker course) may be used between the larger rock and the pavement depending on pavement type, working surface required to place the pavement, and base aggregate size (see sections below on specific pavement type and leveling or choker course guidelines). Typical void space in base layers range from 20% to 40% ([WSDOT, 2003](#)), ([Cahill et al., 2003](#)). Depending on the target flow control standard, ground water and underlying soil type, retention or detention

requirements can be partially or entirely met in the aggregate base. Aggregate base depths of 6 to 36 inches are common depending on pavement type, structural design, storage needs, and environmental factors such as cold weather ([WSU - PSP, 2012](#)).

Flexible pavements (e.g., porous asphalt and permeable pavers) require proper aggregate base material for structural stability. Rigid pavements (pervious concrete) do not require an aggregate base for structural stability; however, a minimum depth of 6 inches is recommended for stormwater storage and providing a uniform surface for applying pervious concrete ([WSU - PSP, 2012](#)).

Increasing aggregate base depth for stormwater storage provides the additional benefit of increasing the strength of the overall pavement section by isolating underlying soil movement and imperfections that may otherwise be transmitted to the wearing course ([Cahill et al., 2003](#)). For more information on aggregate base material and structural support, see [Types of Permeable Pavement](#) for aggregate base recommendations by specific pavement type.

### **Geotextile and Geogrids (Optional)**

If geotextile is used between the subgrade and base aggregate, take the following actions:

- Use geotextile recommended by the manufacturer's specifications and recommendations of a licensed engineer in the state of Washington with geotechnical expertise for the given subgrade soil type and base aggregate.
- Extend the fabric up the sides of the excavation in all cases. This is especially important if the base is adjacent to conventional paving surfaces. The fabric can help prevent migration of fines from dense-graded base material and soil subgrade to the open graded base. Geotextile is not required on the sides if concrete curbs extend the full depth of the base/subbase.
- Overlap adjacent strips of fabric  $\geq 24$  inches. Leave enough fabric to completely wrap over small installations (e.g., sidewalks) or the edge of larger installations adequately to prevent sediment inputs from adjacent disturbed areas. Secure fabric outside of storage bed.
- After placement of base aggregate and again after placement of the pavement, fold the geotextile (if used) over the placements and secure it to protect the installation from sediment inputs. Excess geotextile should not be trimmed until the site is fully stabilized ([USACE, 2003](#)).

### **Porous Hot-Mix Asphalt**

#### **Aggregate Base/Storage Bed Installation**

- Stabilize area and install erosion control to prevent runoff and sediment from entering storage bed.
- Geotextile fabric (optional): See [Geotextile and Geogrids \(Optional\)](#).
- Install base aggregate in maximum of 8-inch lifts and lightly compact each lift. Compact complete aggregate base with a minimum 10-ton vibratory roller. Use a 13,500 pound force (lbf) plate compactor with a compaction indicator in places that can't be reached by roller compactor. Make two passes with the roller in vibratory mode and two passes in static mode until there is no visible movement of the aggregate. Moist aggregate will compact more thoroughly than dry aggregate. Do not crush the aggregate during compaction. Compacted aggregate subbase and base should not rut under aggregate delivery trucks or other

construction equipment.

- Use back dumping method described previously in this section to protect the subgrade from compaction.
- If used, install choker course evenly over surface of coarse aggregate base and compact.
- Behind asphalt delivery trucks and in front of asphalt installation, rake out ruts caused by delivery trucks to provide a uniform surface and pavement depth.

### **Pavement or Wearing Course Installation**

The porous asphalt pavement installations use the same equipment and similar procedures as conventional asphalt with three notable differences:

1. Mixing temperature should be 260°F to 280°F and 240°F to 260°F for lay down. Air temperature should be no lower than 45°F and rising.
2. The stiffer performance grade for the bituminous asphalt cement adheres more to delivery trucks and installation machinery; accordingly, additional time is necessary to clean equipment.
3. Porous asphalt aggregate base and choker courses are relatively uniform gradations and low in fine material. As a result, equipment operating on the aggregate base will cause more rutting than on more densely graded base material for conventional pavement and will require more hand labor to smooth ruts and prevent areas where the pavement is either too thin or too thick.

### **General Installation**

- Install porous asphalt system toward the end of construction activities to minimize sedimentation. The subgrade can be excavated to within 6 to 12 inches of final subgrade elevation and grading completed in later stages of the project ([Cahill et al., 2003](#)).
- Erosion and introduction of sediment from surrounding land uses should be closely controlled during and after construction. Erosion and sediment controls should remain in place until area is completely stabilized with soil amendments and landscaping.
- Insulated covers over loads during hauling can reduce heat loss during transport and increase working time ([Diniz, 1980](#)). Temperatures at delivery that are too low can result in shorter working times, increased labor for hand work, and increased cleanup from asphalt adhering to machinery (personal communication between C. Hinman and L. Spadoni, 2004).
- Rising water in the underlying aggregate base should not be allowed to saturate the pavement ([Cahill et al., 2003](#)). A positive overflow (elevated drain) can be installed to ensure that the asphalt top course is not saturated from excessively high water levels in the aggregate base.

### **Minimum Infiltration Rate for the Porous Hot Mix Asphalt**

The minimum infiltration rate for newly placed porous asphalt should be 200 in/hr. Use ASTM C1701/C1701M-09 to test infiltration rates at locations representative of the pavement finished product at a maximum rate of 5,000 square feet (sf) per test.

## Portland Cement Pervious Concrete

ACI 522.1-08 is the current national standard for specification of pervious concrete pavement. This manual defers to the current version of ACI 522.1-08 for developing pervious concrete pavement specifications. Included below are specific sections of ACI 522.1-08 relevant to infiltration rates, subgrade preparation, and aggregate base placement relevant to the region and developed from national experience.

## Aggregate Base/Storage Bed Installation

- Stabilize area and install erosion control to prevent runoff and sediment from entering storage bed.
- Geotextile fabric (optional): See [Geotextile and Geogrids \(Optional\)](#)
- Install coarse aggregate in maximum of 8-inch lifts and compact each lift (USACE, 2003). Use back dumping method described previously in this section to protect the subgrade from compaction.
- If utilized, install a 1- to 2-inch leveling course (typically No. 57 AASHTO crushed, washed rock) evenly over surface of coarse aggregate base and lightly compact to stabilize to provide a more stable, uniform working surface and reduce variation in thickness.

## Pavement installation

- See [Quality Control, Testing and Verification](#) for confirming correct mixture and proper installation.
- With the correct water content, the delivered mix should contain a cement paste that smoothly covers all the aggregate particles that does not slide off or drain from the particles. The paste should cause the aggregate particles to adhere to each other.
- Pervious concrete mix should be placed within 60 minutes of water being introduced to the mix, and within 90 minutes of using an extended set control admixture (ACI 522.1-08) or an admixture recommended by the manufacturer.
- Adding water in the truck at the point of discharge of the concrete should be allowed to attain optimum mix consistency, workability, placement, and finish (ACI 522.1-08).
- Base aggregate should be wetted to reduce moisture loss and improve the curing process of pervious concrete.
- Concrete should be deposited as close to its final position as possible directly from the truck, using a conveyor belt or hand or powered carts (pervious concrete mixes are stiff and cannot be pumped).
- Several screed and compaction methods can be used, including low-frequency vibrating truss screeds, laser screeds, and a hand screed that levels the concrete at the top of the form (typically 3/8 to 3/4 inches). The surface is then covered with 6-millimeter plastic, and a static drum roller is used for final compaction (roller should provide approximately 10 pounds per square inch (psi) vertical force). A method that is becoming more prevalent and has advantages for quality of finish and speed uses rotating Bunyan screeds or hydraulically powered screeding drums that provide proper compaction at the finished elevation and a



nearly finished surface in one operation. Hydraulically operated screeding drums come in various lengths and diameters.

- Placement widths should not exceed 15 feet unless contractor can demonstrate competence with test panels or previous installations to install greater widths.
- High frequency vibrators can seal the surface of the concrete and should not be used.
- Jointing: Shrinkage associated with drying is significantly less for pervious than conventional concrete. Accordingly, control joints are optional. If used, spacing of joints should follow the rules for conventional concrete and should typically be spaced at maximum 15- to 20-foot intervals. Joint depth should be one-quarter to one-third the depth of the pavement thickness. Control joints can also facilitate a cleaner break point if sections become damaged or are removed for utility work.

## **Curing**

Due to its porous, open structure, pervious concrete dries rapidly. If curing is not controlled, the bond between the aggregate becomes weak and structural integrity will be seriously compromised.

Curing is, therefore, a critical step in pervious concrete installation and the following steps should be carefully planned and implemented (ACI 522.1-08):

- Completely cover surface and edges with 6-millimeter plastic within 20 minutes of concrete discharge. The surface and edges should remain entirely covered for the entire curing time.
- Curing time: 7 days for pervious concrete with no additives and 10 days for mixtures that incorporate supplementary cementitious materials, such as fly ash and slag (ACI 522.1-08).
- Secure all edges adequately so that the plastic cannot be dislodged during cure time. Lumber, reinforcing bars, and concrete blocks can be used to secure the plastic continuously along the perimeter. If wooden forms are used, riser strips can be nailed back in place to secure plastic. Do not use dirt, sand or other granular material on the plastic because the sediment may wash or spill into the pores of the concrete during rainfall or removal of plastic (ACI 522.1-08).

**Note:** Admixtures are now becoming available that reduce or eliminate the need to cover the pavement installation with plastic. Consult ACI 522.1-08, industry representatives, and suppliers for recommendations.

## **Quality Control, Testing and Verification**

The following provides a summary of quality control in ACI 522.1-08. Quality control and testing procedures to verify proper placement include test panels, fresh and hardened density, and average compacted thickness of the installation. It is critically important to require adequate National Ready Mix Concrete Association (NRMCA)-certified placement personnel and contractor experience for the installation (see ACI 522.1-08 for more details). There are currently no generally accepted standardized methods to test compression or flexural strength of pervious concrete, and tests used for conventional concrete are not applicable due to the high variability in strength within the porous structure of pervious concrete and should not be used for verification (ACI 522.1-08).

The contractor should place test panels using mix proportions, materials, personnel, and equipment proposed for the project. Test the fresh and hardened density and thickness of the test panel(s). See the current version of ACI 522.1-08 for test procedures and tolerances. If the test panel is outside

acceptable limits for one or more of the verification tests, the panel should be removed and replaced at the contractor's expense. If the test panel is accepted it may be incorporated into the completed installation.

Obtain a minimum 1 cf sample for fresh density testing for each day of placement (see ACI 522.1-08 for test procedures and tolerances).

Remove three cores per 5,000 sf not less than 7 days after placement to verify placement hardened density and thickness. See ACI 522.1-08 for test procedures and tolerances. If the tested portion of the installation is outside acceptable limits for 1 or more of the verification tests, the installation is subject to rejection and should be removed and replaced at the contractor's expense unless accepted by the owner ([WSU - PSP, 2012](#)).

### **Minimum Infiltration Rate for Pervious Concrete**

The minimum infiltration rate for newly placed pervious concrete should be 200 in/hr. Use ASTM C1701/C1701M-09 to test infiltration rates of the test panel and at locations representative of the pavement finished product at a maximum rate of 5,000 sf per test.

### **Verifying Subgrade Infiltration Rates**

Infiltration tests can also be used once subgrade preparation is complete to verify that infiltration rates used for design have not been significantly reduced from compaction. Pilot infiltration tests, and associated excavation beneath the pilot infiltration test (PIT) elevation, are not recommended at this stage in order to maintain the structural integrity of the subgrade. Rather, large-scale ring infiltrometer tests are recommended for accuracy and minimal subgrade disturbance.

**For more information:** See [6.B.3 Recommended Field Test Procedures](#), for the single-ring infiltrometer test method.

Utility excavations under or beside the road section can provide pits for soil classification, textural analysis, stratigraphy analysis, and/or infiltration tests and minimize time and expense for permeable pavement infiltration tests.

### **Permeable Interlocking Concrete Pavers**

The ICPI provides technical information on best practices for PICP design, specification, construction, and maintenance. Manufacturers or suppliers of particular pavers should be consulted for materials and guidelines specific to that product. Experienced contractors with a certificate in the ICPI PICP Installer Program should perform installations. The following provides construction guidelines that apply broadly to permeable interlocking concrete pavers.

### **Aggregate Base/Storage Bed Installation**

Stabilize area and install erosion control or diversion to prevent runoff and sediment from entering aggregate subbase, base, and pavers. Prevent sediment from contaminating aggregate base material if stored on-site.

If using the base course for retention in parking areas, excavate subgrade level to allow even distribution of water and maximize infiltration across entire parking area.

Geotextile fabric (optional):

- Geotextiles are recommended on the sides of excavations where a full-depth concrete curb is not used to prevent erosion of adjacent soil into the aggregate base. The fabric should extend  $\geq 1$  foot onto the subgrade bottom. A minimum overlap of 1 foot is recommended for well-drained soils and 2 feet for poorly draining soils ([Smith, 2011](#)).
- The use of geotextiles on the bottom of the subgrade excavation is optional.
- See [Geotextile and Geogrids \(Optional\)](#).

Install No. 2 rock in 6-inch lifts. Use back dumping method described previously in this section to protect subgrade from compaction. Compact with  $\geq 4$  passes of a 10-ton steel drum vibratory roller or a 13,500 lbf plate compactor. The first two passes should be with vibration, and the final two passes should be static. Consolidation of the subbase is improved if the aggregate is wet. Compaction is complete when there is no visible movement in the subbase as the roller moves across the surface ([Smith, 2011](#)).

The No. 57 rock base can be spread as one 4-inch lift. Compact with  $\geq 4$  passes of a 10-ton steel drum vibratory roller or a 13,500 lbf plate compactor. The first two passes should be with vibration and the final two passes should be static. The No. 57 rock should be installed moist to facilitate proper compaction.

Adequate density and stability are developed when no visible movement is observed in the base as the roller moves across the surface (personal communication between C. Hinman and D. Smith). If field testing is required, a nuclear density gauge can be used on the No. 57 base in backscatter mode; however, this type of test is not effective/appropriate for the larger No. 2 subbase rock. A nonnuclear stiffness gauge can be used to assess aggregate base density as well ([Smith, 2011](#)).

Asphalt stabilizer can be used with the No. 57 and/or the No. 2 rock if additional bearing support is needed, but should not be applied to the No. 8 aggregate. To maintain adequate void space, use a minimum of asphalt for stabilization (approximately 2 to 2.5% by weight of aggregate). An asphalt grade of AC20 or higher is recommended. The addition of stabilizer will reduce storage capacity of base aggregate and should be considered in the design ([Smith, 2000](#)).

### **Bedding Layer Installation**

Install 2 inches of moist No. 8 rock for the leveling or choker course over compacted base. Screed and level No. 8 rock to within  $\pm 3/8$  inches over 10 feet surface variation. The No. 8 aggregate should be moist to facilitate movement into the No. 57 rock. Keep construction equipment and foot traffic off screed bedding layer to maintain uniform surface for pavers.

### **Paver Installation**

- Pavers should be installed immediately after base preparation to minimize introduction of sediment and to reduce the displacement of bedding and base material from ongoing activity ([Smith, 2000](#)).
- Place pavers by hand or with mechanical installer. Paver joints are filled with No. 8, No. 89, or No. 9 rock. Spread and sweep with shovels and brooms (for small jobs) or small track loaders and power brooms or sweepers (for larger installations). Fill joints to within 0.25 inches and sweep surface clean for final compaction to avoid marring pavers with loose rocks on the surface.

- To maximize efficiency and reduce cost of mechanical installation, consult with the supplier to deliver pavers in layers that will be picked up by the installation machine in the final installed pattern.
- For installations > 50,000 square feet that are installed with mechanical equipment, consult with the paver manufacturer to monitor paver dimension and consistency of paver layers so that layers continue to fit together appropriately throughout installation.
- Cut pavers along borders should be no smaller than one-third of a whole paver if subjected to vehicle loading.

**Note:** Do not use sand to fill paver openings or joints unless specified by the manufacturer. Sand in paver openings and joints can clog easily and will significantly reduce surface infiltration and system performance if system is not specifically designed for sand.

- Compact pavers with a 5,000 lbf, 75- to 90-hertz (Hz) plate compactor. Use a minimum of two passes with each subsequent pass perpendicular to the prior pass.
- If aggregate settles to > 0.25 inches from the top of the pavers, add rock, sweep clean, and compact again. The small amount of finer aggregate in the No. 8 rock will likely be adequate to fill narrow joints between pavers in pedestrian and vehicle applications. Sweep in additional material as required. ASTM No. 89 or No 9 rock can be used to fill spaces between pavers with narrow joints. In all cases, however, the bedding material should be ASTM No. 8 rock ([Smith, 2011](#)).
- For installations intended for vehicles, proof roll with  $\geq$  two passes of a 10-ton rubber-tired roller.
- Do not compact pavers within 6 feet of unrestrained edges ([Smith, 2011](#)).
- The PICP installation contractor should return to the site after 6 months from completion of the work and provide the following if necessary: fill paver joints with rocks, replace broken or cracked pavers, and relevel settled pavers to specified elevations. Any rectification work should be considered part of original bid price with no additional compensation.

**For more information:** For detailed design guidelines and a construction specification, see *Permeable Interlocking Concrete Pavements: Design, Specifications, Construction, Maintenance* ([Smith, 2011](#)).

## **Plastic or Concrete Grid Systems**

### **Aggregate Base/Storage Bed Installation**

- Stabilize area and install erosion control to prevent runoff and sediment from entering storage bed.
- If using the base course for retention in parking areas, excavate storage bed level (if possible) to allow even distribution of water and maximize infiltration across entire parking area (terrace parking area if sloped).
- Geotextile fabric (optional): [Geotextile and Geogrids \(Optional\)](#).
- Install aggregate in 6-inch lifts maximum. Use back dumping method described previously in

this to protect subgrade from compaction.

- Compact each lift of dense-graded aggregate base to 95% standard Proctor.

**Note:** For dense-graded bases in light traffic applications, only standard Proctor density is required. Modified Proctor requires more compaction force and expense and is not needed for the light loads to which grid pavements are constructed.

- For open-graded aggregate bases, compact with a minimum 10-ton roller with the first two passes in vibratory mode and the last two in static mode until there is no visible movement of the aggregate.

### **Top Course Installation**

- Grid should be installed immediately after base preparation to minimize introduction of sediment and to reduce the displacement of base material from ongoing activity.
- Place grid with rings up and interlock male/female connectors along unit edges.
- Install anchors if not integral to the plastic grid. Higher speed and transition areas (e.g., where vehicles enter a parking lot from an asphalt road) or where heavy vehicles execute tight turns will require additional anchors.
- Aggregate fill should be back dumped to a minimum depth of 6 inches so that delivery vehicle exits over aggregate. Sharp turning on rings should be avoided.

### **Aggregate Fill**

- Spread gravel using power brooms, flat bottom shovels or wide asphalt rakes. A stiff bristle broom can be used for finishing.
- If necessary, aggregate can be compacted with a plate compactor to a level no less than the top of the rings or  $\leq 0.25$  inches above the top of the rings ([Invisible Structures, 2003](#)).

### **Grass Systems**

- Spread sand or soil using power brooms, flat bottom shovels or wide asphalt rakes. A stiff bristle broom can be used for finishing.
- Lay sod or seed. Grass installation procedures vary by product. Consult manufacturer or supplier for specific grass installation guidelines.
- Provide edge constraints along edges that may have vehicle loads (particularly tight radius turning). Cast-in-place or precast concrete is preferred.
- Concrete grids require edge restraints along edges in all applications. Plastic grids require restraints when exposed to vehicles. Edge restraints for concrete or plastic grids in such applications should be cast-in-place or precast concrete.

### **Operation and Maintenance Criteria**

#### **Maintenance Recommendations for All Permeable Pavement Types**

- Erosion and introduction of sediment from surrounding land uses should be strictly controlled after construction by amending exposed soil with compost and mulch, planting exposed areas as soon as possible, and armoring outfall areas.

- Surrounding landscaped areas should be inspected regularly and possible sediment sources controlled immediately.
- Clean permeable pavement surfaces to maintain infiltration capacity at least once or twice annually following recommendations below.
- Utility cuts should be backfilled with the same aggregate base used under the permeable pavement to allow continued conveyance of stormwater through the base, and to prevent migration of fines from the standard base aggregate to the more open graded permeable base material ([Diniz, 1980](#)).
- Deicing and sand application is not recommended. The permeable pavement installation should be assessed during winter months and the winter traction program developed from those observations. Vacuum and sweeping frequency will likely be required more often if sand is applied.
- Erosion and introduction of sediment from surrounding land uses should be strictly controlled after construction by amending exposed soil with compost and mulch, planting exposed areas as soon as possible, and armoring outfall areas.
- Surrounding landscaped areas should be inspected regularly and possible sediment sources controlled immediately.
- Clean permeable pavement surfaces to maintain infiltration capacity at least once or twice annually following the recommendations in the following subsection.
- Utility cuts should be backfilled with the same aggregate base used under the permeable pavement to allow continued conveyance of stormwater through the base, and to prevent migration of fines from the standard base aggregate to the more open graded permeable base material ([Diniz, 1980](#)).
- Ice buildup on permeable pavement is reduced and the surface becomes free and clear more rapidly compared to conventional pavement.
- Deicing and sand application is not recommended. The permeable pavement installation should be assessed during winter months and the winter traction program developed from those observations. Vacuum and sweeping frequency will likely be required more often if sand is applied.
- See [Appendix 6-A: Recommended Maintenance Criteria for Flow Control BMPs](#) for recommended maintenance criteria.

## **Maintenance Recommendations for Specific Permeable Pavement Surfaces**

### **Porous Asphalt and Pervious Concrete**

- Clean surfaces using suction, sweeping with suction or high-pressure wash, and suction (sweeping alone is minimally effective). Hand held pressure washers are effective for cleaning void spaces and appropriate for smaller areas such as sidewalks.
- Small utility cuts can be repaired with conventional asphalt or concrete if small batches of permeable material are not available or are too expensive.

## Permeable Interlocking Concrete Pavers

- ICPI recommends cleaning if the measured infiltration rate per ASTM C1701/C1701M-09 decreases to < 10 in/hr ([Smith, 2011](#)).
- Use sweeping with suction when surface and debris are dry one to two times annually (see next bullet for exception for badly clogged installations).
  - Apply vacuum to a paver test section and adjust settings to remove all visible sediment without excess uptake of aggregate from paver openings or joints.
  - If necessary, replace No. 8, No. 89, or No. 9 rock to specified depth within the paver openings.
  - Washing or power washing should not be used to remove debris and sediment in the openings between the pavers ([Smith, 2000](#)).
- For badly clogged installations, wet the surface and vacuumed aggregate to a depth that removes all visible fine sediment and replace with clean aggregate.
- If necessary, use No. 8, No. 89, or No. 9 rock for winter traction rather than sand (sand will accelerate clogging).
- Pavers can be removed individually and replaced when utility work is complete.
- Replace broken pavers as necessary to prevent structural instability in the surface.
- The structure of the top edge of the paver blocks reduces chipping from snowplows. For additional protection, skids on the corner of plow blades are recommended.

## Plastic or Concrete Grid Systems

- Remove and replace top course aggregate if clogged with sediment or contaminated (vacuum trucks for storm drains can be used to remove aggregate).
- Remove and replace grid segments where three or more adjacent rings are broken or damaged.
- Replenish aggregate material in grid as needed.
- Snowplows should use skids to elevate blades slightly above the gravel surface to prevent loss of top course aggregate and damage to plastic grid.
- For grass installations, use normal turf maintenance procedures except do not aerate. Use very slow release fertilizers if needed.

## 6.4 Evaporation BMPs

### BMP F6.30: Evaporation Ponds

This section provides the methods for the design of evaporation ponds, which can be used to collect and dispose of stormwater when surface discharge is not available or the soils are not conducive to infiltration BMPs.

For the design of evaporation ponds, a water budget is required. A cumulative, month-by-month water budget is performed as follows:

### **Equation 6.7: Evaporation Pond Water Budget**

$$V_{in} - V_{out} = \Delta V_{month}$$

$$\sum V_{month} = \Delta V_{year}$$

where:

$V_{in}$  = Volume of water into evaporation pond, usually cubic feet (cf)/month.  $V_{in}$  is a combination of stormwater runoff, direct rainfall onto the pond surface, ground water seepage into evaporation pond, and any other source of water into the pond.

$V_{out}$  = Volume of water out of the evaporation pond (usually 1 cf/month).  $V_{out}$  is all outflows; it can be a combination surface evaporation, plant evapotranspiration, ground infiltration, or any other qualified outflow.

$\Delta V_{month}$  = Net volume of storage increase (or decrease) into the evaporation pond (usually cf/month).

$\Delta V_{year}$  = Cumulative net volume of storage in evaporation pond until storage equilibrium is obtained. Equilibrium is obtained when the volume of water in the cycle is less than the volume stored at the beginning of the cycle, evaluated over at least 2 calendar years.

It is recommended that a freeboard of  $\geq 1$  foot be maintained in the pond at all times. The use of a spreadsheet to perform the calculations can be helpful.

The water budget cycle should be performed on a month-by-month basis, until a steady-state condition occurs (i.e., the volume at the end of the cycle is less than or equal to the volume at the start of the cycle). The minimum duration of the water budget cycle is to be 2 years. The cycle is to start in the month which yields the greatest net storage volume for the year. Normally, beginning the water budget in September, October, or November produces the largest required storage volume. Contributing off-site areas are to be included in the analysis, considering existing locations.

The climatological data source for evaporation and mean annual precipitation rates used in the water budget are available from the National Oceanic and Atmospheric Administration (NOAA), or other reliable sources. The Western Regional Climate Center is another source of precipitation data (<http://www.wrcc.dri.edu/summary/climsmwa.html>). Average monthly precipitation rates and average monthly evaporation rates should be used in the water budget analysis, as a minimum.

**Note:** The Underground Injection Control (UIC) regulations do not apply to evaporation ponds (see [5.6 Subsurface Infiltration \(Underground Injection Control Wells\)](#)).

### **Runoff Volume Determinations**

Runoff volume from the basin directing stormwater into the evaporation ponds shall be included in the water budget analysis. Runoff volume can be determined using the Soil Conservation Service (SCS) hydrograph method or other methods approved by the local jurisdiction.

When preparing the water budget, antecedent moisture conditions need to be considered during the months of the year when the ground may be saturated or frozen. For the SCS method, the curve



numbers (CNs) should be adjusted as shown in [Table 6.6: Curve Number Adjustment for Antecedent Moisture Condition](#) and [4.5 Single-Event Hydrograph Methods](#). This requirement is applicable in Climate Regions 1, 3, and 4 only. Climate Region 2 should use AMC II CNs throughout the year.

**Table 6.6: Curve Number Adjustment for Antecedent Moisture Condition**

Month	Antecedent Moisture Condition (AMC)	Minimum Runoff Curve Number (CN)
April–October	Normal (AMC = II)	See <a href="#">Table 4.14: Runoff Curve Numbers (CNs) for Selected Agricultural, Suburban, and Urban Areas</a>
November, March	Wet (AMC = III)	See <a href="#">Table 4.15: Total 5-Day Antecedent Rainfall</a>
December–February	N/A	95

Water loss through evaporation from overland surface areas is normally not to be considered in the water budget, for the areas contributing runoff to the evaporation pond(s), due to the wide variation in evaporation rates which occur over these types of surfaces. The only reduction which can be considered in the analysis is runoff interception and surface infiltration, which are normally accounted for in the SCS CNs or rational coefficients.

Disposal is primarily through evaporation from the pond surface. Credit for infiltration through soils will not be considered in the water budget analysis in the absence of any site-specific infiltration testing work being performed.

Geosynthetic or natural liners may be used to limit infiltration outflow volumes in areas where this is desired, or in locations where the seasonal water table will adversely impact the pond.

### ***Other Design Considerations***

When credit for infiltration is proposed, site characterization, testing, and reporting must be done in accordance with [6.3 Infiltration BMPs](#).

The design of the evaporation pond will need to evaluate the potential of ground water seeping into the pond from the surrounding area for an unlined pond and evaluate the potential for ground water mounding or uplift for a lined pond. A geotechnical evaluation should be performed, evaluating this potential adverse impact, and, if needed, mitigation measures should be provided.

Sources of imported water need to be considered in the water budget design and calculations. Other sources may include irrigation, sewer septic tank/drain field systems, natural springs, foundation drains, dewatering wells, etc. The qualified professional preparing the water budget shall include sources of any imported water in the water budget analysis.

The maximum water surface elevation permissible in the water budget is to be below the finish floor elevations of the surrounding buildings (existing or proposed). Privately owned parking lot areas, can be used for temporary storage of stormwater and considered in the water budget analysis. If

ponding is proposed in parking lot areas, the maximum water depth should normally not exceed 1 foot.

If snow removal operations deposit snow into an evaporation pond, this added factor must be considered in the water budget, especially if snow from another basin is put into the system. Temporary sediment ponds should be included in the design, to prevent sediment-laden runoff from entering the pond and storm disposal system during construction.

### **Example Calculations**

An example of the inputs and results for a sample project site is shown in [Table 6.7: Example Calculations for Sizing an Evaporation Pond at a Site in the Spokane Area](#).

For this scenario, the overall drainage basin is 8.00 acres (on-site and off-site, Type B soils, with off-site being uphill and flowing onto the site). The example shown is for full evaporation without discharge via detention to a natural or existing drainage channel.

The example uses data from the nearest station with average monthly precipitation and pan evaporation data available. The monthly precipitation value is adjusted based on the site location. Because evaporation data is collected using a shallow, metal evaporation pan that is fully exposed to sun and wind and affected by heat exchanges within the pan, the pan evaporation rate must be adjusted; the adjustment coefficient should be between 70% and 80%.

The total site area assumes that no off-site property is available for locating the pond; thus the calculations will need to be adjusted as the pond size goes up or down. The starting point for the pond bottom area is generally to assume 25% of the total site for a typical commercial development.

The pond bottom perimeter is calculated as a square but can be entered manually if the pond perimeter is known. Remember that the perimeter will change if the pond bottom area is increased or decreased during design iterations. As the proposed pond bottom area changes, the portion of the impervious basin area attributed to the pond surface will also change.

The calculations are iterated for 2 or more years in order to see when the pond has reached a steady state: there should be a decrease the following year in the month with the largest storage (March in the example shown). The calculations assume that the pond contains a dead storage of the equivalent of the 100-year design flow volume because typically, the only time a full evaporation pond is needed is when there is no discharge point, no infiltrative capacity available, existing high ground water, or potential for adjacent or downgradient property damage from additional stormwater being injected into the subsurface. The extra capacity provides emergency storage in the event that a site experiences above average total annual precipitation.

Some of the design criteria for this example may need to be adjusted for local requirements. For example, the Spokane County guidelines state the following:

- For impervious surfaces such as roads, sidewalks, and driveways, the AMC II CN is 98, and the AMC III CN is 99. From December through February, the assumption is that if the CN of 98 goes up to 99 during the wet months, it will not revert to 98 during frozen ground conditions.
- During December through February, the CN for permeable surfaces is 95 regardless of the AMC II or III CNs, meant to approximate runoff from permeable surfaces during snowpack

buildup and snowmelt.

- One foot of freeboard is needed above the maximum water surface elevation of the pond.

**Table 6.7: Example Calculations for Sizing an Evaporation Pond at a Site in the Spokane Area**

Project : <b>EXAMPLE SITE IN SPOKANE AREA</b>	
Plat / BSP / Proj No: ###	Engineer: initials
Date: 8/10/2004	
Pond Bottom Area:	112,000 sq. ft.
Pond Bottom Perimeter:	1,339 ft
Pond Side Slopes:	3 : 1
Impervious Basin Size (Constant):	2.00 acres
Impervious Basin Size (Pond Area):	2.57 acres
Permeable Basin Size:	2.43 acres
Off-Site Upstream Basin:	1.00 acres
Total Basin Size:	8.00 acres
Mean Annual Prec. - Airport:	16.11 in
Mean Annual Prec. - Site:	19.70 in
Multiplier:	1.22
100-Year, 24 Hour, Prec.:	2.70 in

Evaporative Pond to Accommodate 100% of Post-Developed Runoff Volume  
(no infiltration allowed)

CONDITION: FULL CONTAINMENT

	AMC II Apr-Oct	AMC III Nov&Mar	--- Dec-Feb
Impervious CN:	98	99	99
Permeable CN:	61	78	95
Off-Site CN:	58	76	95
Impervious S:	0.20	0.10	0.10
Permeable S:	6.39	2.82	0.53
Off-Site S:	7.24	3.16	0.53

<b>RESULTS:</b>
Pond Volume: 246,080 cu ft
Pond Depth: 2.20 ft
Add 1' freeboard: 3.20 ft

Month	Precip. (in)	Adjusted Precip. (in)	INFLOW			OUTFLOW				STORAGE		POND DATA		
			Impervious Runoff Depth (in)	Permeable Runoff Depth (in)	Off-Site Runoff Depth (in)	Impervious Runoff Volume (cu ft)	Permeable Runoff Volume (cu ft)	Off-Site Runoff Volume (cu ft)	NET Runoff Volume (cu ft)	Pan Evap. (in)	Evap. Vol. Out; (72% Adj.) (cu ft)	Volume Stored in Pond (cu ft)	Pond Depth (ft)	Pond Capacity (%)
Oct.	1.22	1.49	1.27	0.01	0.00	21,109	61	1	21,171	2.58	17,453	20,878	0.19	8
Nov.	2.02	2.47	2.35	0.77	0.68	39,043	6,777	2,456	48,276	0.92	6,231	24,595	0.22	10
Dec.	2.22	2.71	2.60	2.17	2.17	43,095	19,145	7,882	70,123	0.51	3,500	133,263	1.19	52
Jan.	2.05	2.51	2.39	1.97	1.97	39,651	17,368	7,151	64,169	0.61	4,274	193,157	1.72	76
Feb.	1.57	1.92	1.80	1.41	1.41	29,930	12,402	5,106	47,438	1.11	7,920	232,675	2.08	91
Mar.	1.38	1.69	1.57	0.32	0.26	26,086	2,821	961	29,868	2.28	16,463	246,080	2.20	96
Apr.	1.11	1.36	1.14	0.00	0.00	18,914	8	0	18,922	4.45	32,260	232,742	2.08	91
May	1.37	1.68	1.45	0.02	0.01	24,111	204	25	24,340	6.69	48,307	208,776	1.86	82
June	1.27	1.55	1.33	0.01	0.00	22,109	100	5	22,214	8.14	58,357	172,633	1.54	67
July	0.50	0.61	0.42	0.00	0.00	6,974	0	0	6,974	10.70	75,878	103,728	0.93	41
Aug.	0.60	0.73	0.54	0.00	0.00	8,881	0	0	8,881	9.42	65,405	47,205	0.42	18
Sept.	0.80	0.98	0.77	0.00	0.00	12,775	0	0	12,775	5.90	40,247	19,733	0.18	8
Oct.	1.22	1.49	1.27	0.01	0.00	21,109	61	1	21,171	2.58	17,447	23,456	0.21	9
Nov.	2.02	2.47	2.35	0.77	0.68	39,043	6,777	2,456	48,276	0.92	6,229	65,503	0.58	26
Dec.	2.22	2.71	2.60	2.17	2.17	43,095	19,145	7,882	70,123	0.51	3,499	132,127	1.18	52
Jan.	2.05	2.51	2.39	1.97	1.97	39,651	17,368	7,151	64,169	0.61	4,273	192,023	1.71	75
Feb.	1.57	1.92	1.80	1.41	1.41	29,930	12,402	5,106	47,438	1.11	7,918	231,543	2.07	91
Mar.	1.38	1.69	1.57	0.32	0.26	26,086	2,821	961	29,868	2.28	16,457	244,954	2.19	96
Apr.	1.11	1.36	1.14	0.00	0.00	18,914	8	0	18,922	4.45	32,249	231,627	2.07	91
May	1.37	1.68	1.45	0.02	0.01	24,111	204	25	24,340	6.69	48,291	207,677	1.85	81
June	1.27	1.55	1.33	0.01	0.00	22,109	100	5	22,214	8.14	58,338	171,562	1.53	67
July	0.50	0.61	0.42	0.00	0.00	6,974	0	0	6,974	10.70	75,853	102,673	0.92	40
Aug.	0.60	0.73	0.54	0.00	0.00	8,881	0	0	8,881	9.42	65,383	46,171	0.41	18
Sept.	0.80	0.98	0.77	0.00	0.00	12,775	0	0	12,775	5.90	40,234	18,712	0.17	7

### Operation and Maintenance Criteria

Provisions to facilitate maintenance operations must be built into the project when it is installed. Maintenance, including weed control and moving, must be a basic consideration in design and in determination of first cost.

For more information, see [Appendix 6-A: Recommended Maintenance Criteria for Flow Control BMPs](#).

## 6.5 Dispersion BMPs

### 6.5.1 Introduction

Dispersion attempts to minimize the hydrologic changes created by new impervious surfaces by restoring the natural drainage patterns of sheet flow and infiltration. There are four types of dispersion BMPs:

- [BMP F6.40: Concentrated Flow Dispersion](#): Redispersal of concentrated flows from driveways or other pavement areas through a vegetated pervious area, attenuating peak flows by slowing entry of the runoff into the drainage system and allowing some infiltration and water quality benefits.
- [BMP F6.41: Sheet Flow Dispersion](#): Considered the simplest method for flow control and can be used for any impervious or pervious surface that is graded to avoid concentrating flows. Because flows are already dispersed as they leave the surface, they need only traverse a narrow band of adjacent vegetation for effective attenuation and treatment.
- [BMP F6.42: Full Dispersion](#): Allows full dispersal of stormwater runoff from impervious surfaces and cleared areas of commercial and residential development sites that protect a portion of the site (or for large sites, a portion of an area within a subbasin drainage on the site) in a natural, native vegetation cover condition and prevents runoff from leaving the site. Natural vegetation is preserved and maintained in accordance with guidelines. Runoff from roofs, driveways, and roads within the development is dispersed within the site using the areas of preserved vegetation.
- [BMP F6.43: Channelized Flow Dispersion](#): Redispersal of influent channelized flows to natural or engineered dispersion areas.

### 6.5.2 Purpose

Dispersion is the simplest method of flow control ([2.7.7 Core Element #6: Flow Control](#)), using the vegetation, soils, and topography to effectively provide sheet flow and infiltration. It generally requires little or no construction activity.

The key to dispersion is that flows from the contributing area enter the dispersion area as sheet flow. Because stormwater enters the dispersion area as sheet flow, it only needs to traverse a narrow band of contiguous vegetation for effective attenuation.

Absorption capacity can be gained by using compost-amended soils to disperse and absorb contributing flows to the dispersion area. The goal is to have the flows dispersed into the surrounding landscape such that there is a low probability that any surface runoff will reach a flowing body of water.

**Note:** Flow dispersion is not subject to Underground Injection Control (UIC) regulations (see [5.6 Subsurface Infiltration \(Underground Injection Control Wells\)](#)).

### 6.5.3 Application

- Dispersion is ideal for highways and linear roadway projects.
- Dispersion helps maintain the temperature norms of stormwater because it promotes infiltration, evaporation, and transpiration and should not have a surface discharge to a lake or stream.
- Dispersion areas meet flow control criteria set forth in [2.7.7 Core Element #6: Flow Control](#).

As shown in [Table 6.8: Applicability of Dispersion BMPs for Runoff Treatment, Flow Control, and Conveyance](#), only Full Dispersion ([BMP F6.42: Full Dispersion](#)) can be used to meet runoff treatment and flow control requirements, whereas all dispersion BMPs can be used to help meet flow control requirements only, as well as eliminate or reduce the need for conveyance.

**Table 6.8: Applicability of Dispersion BMPs for Runoff Treatment, Flow Control, and Conveyance**

BMP	Runoff Treatment					Flow Control	Conveyance
	Pretreatment	Basic	Metals	Oil Control	Phosphorus		
<a href="#">BMP F6.40: Concentrated Flow Dispersion</a>						✓	✓
<a href="#">BMP F6.41: Sheet Flow Dispersion</a>						✓	✓
<a href="#">BMP F6.42: Full Dispersion</a>	✓	✓	✓	✓	✓	✓	✓
<a href="#">BMP F6.43: Channelized Flow Dispersion</a>						✓	✓

### 6.5.4 Limitations

- The effectiveness of dispersion relies on maintaining sheet flow to the dispersion area, which maximizes soil and vegetation contact and prevents short-circuiting due to channelized flow.
- Dispersion areas must be protected from future development. See [6.5.7 BMPs for Dispersion](#).
- Note that dispersion areas may initially cost as much as other constructed BMPs (ponds or vaults) because right-of-way or easements often need to be purchased, but long-term maintenance costs are lower. These natural areas will also contribute to the preservation of native habitat and provide visual buffering of the roadway or driveway.
- Do not use dispersion for floodplains.

- Dispersion areas should have no surface water discharge from the dispersion area to a conveyance system or Category I or II wetlands as defined by Ecology’s Wetland Rating System for eastern Washington ([Ecology, 2014](#)).

For project sites with high velocities through the dispersion areas (e.g., > 2 ft/sec or per local jurisdiction requirement), provide energy dissipaters in conjunction with dispersal BMPs to minimize or prevent erosion through the dispersion areas.

The following additional limitations apply to [BMP F6.43: Channelized Flow Dispersion](#):

- Redisperse the channelized flow before entering the dispersion area. Dispersal BMPs create sheet flow conditions.
- Channelized flows are limited to on-site flows. If off-site flows contribute to the project site, provide parallel conveyance systems as needed to divert off-site flows around channelized dispersion BMPs. In some situations, it may be more beneficial to disperse off-site flows.

### **6.5.5 Cold Climate Considerations**

Dispersion BMPs can be effective in cold climates, but may be restricted by ground water quality concerns related to infiltration of chlorides. Frozen ground may inhibit the infiltration capacity of the ground. Grasses or other vegetation used in dispersion BMPs may also be dormant and may provide less effective treatment mechanisms, such as filtration or pollutant uptake, during the winter. For vegetated BMPs, plants should be selected to be tolerant of cold and freezing climates.

**For more information:** See [5.2.4 Cold Weather Considerations](#) for additional cold weather considerations.

### **6.5.6 Arid and Semiarid Climate Considerations**

In arid/semiarid portions of eastern Washington, grasses and plants should be selected to be drought tolerant and not require watering after establishment (2 to 3 years). In more arid environments, watering may be needed during prolonged dry periods after plants are established.

### **6.5.7 BMPs for Dispersion**

#### **BMP F6.40: Concentrated Flow Dispersion**

Dispersion of concentrated flows from driveways or other pavement through a vegetated pervious area attenuates peak flows by slowing entry of the runoff into the conveyance system, allows for some infiltration, and provides some water quality benefits. Concentrated flow dispersion is not subject to Underground Injection Control (UIC) regulations (see [5.6 Subsurface Infiltration \(Underground Injection Control Wells\)](#)).

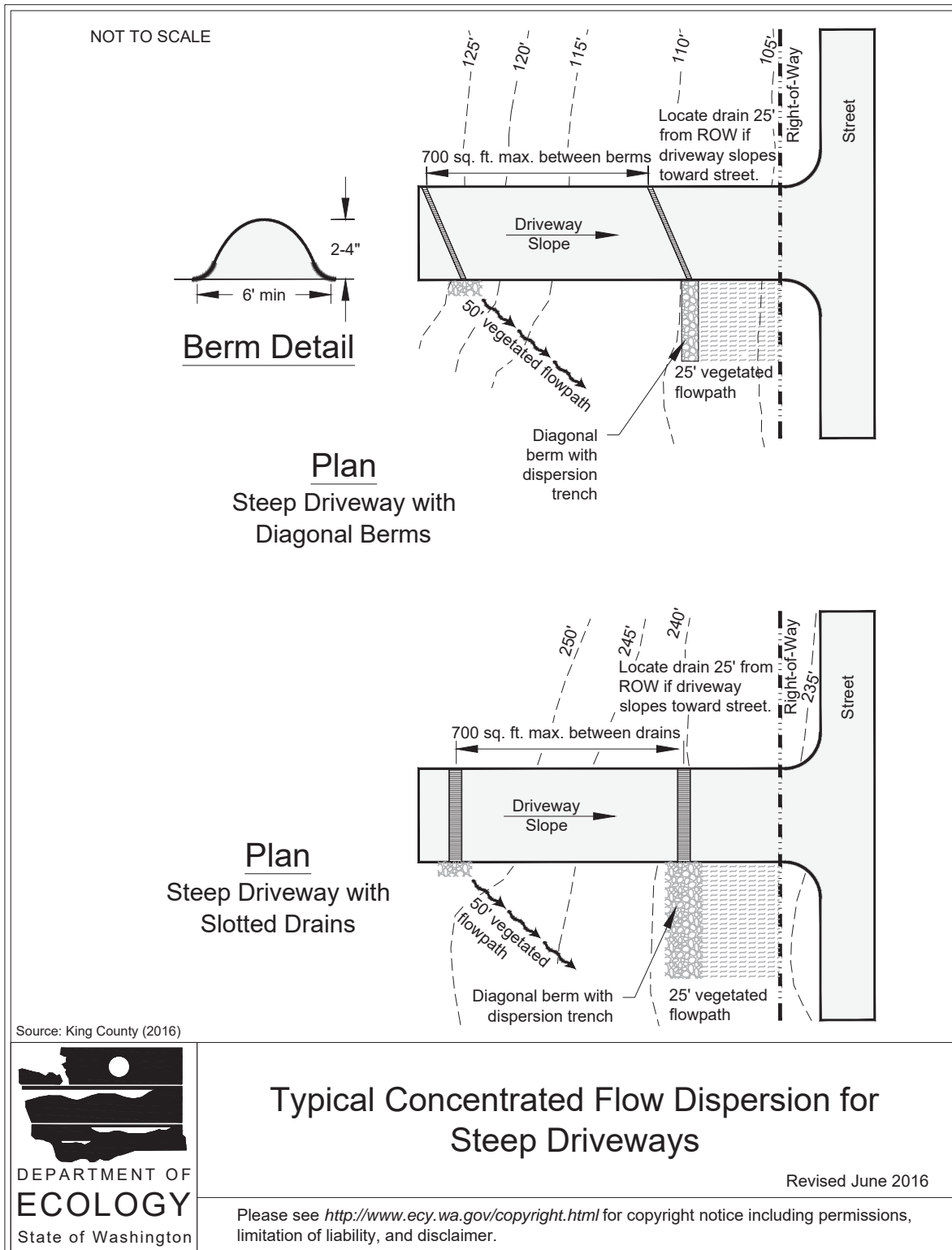
#### ***Applications and Limitations***

- Any situation where concentrated flow can be dispersed through vegetation.
- Dispersion for driveways will generally be effective only for single-family residences on large lots and in rural short plats. Lots proposed by short plats in urban areas will generally be too

small to provide effective dispersion of driveway runoff.

- [Figure 6.30: Typical Concentrated Flow Dispersion for Steep Driveways](#) shows two possible ways of spreading flows from steep driveways.

**Figure 6.30: Typical Concentrated Flow Dispersion for Steep Driveways**





## **General Criteria**

- Maintain a vegetated flow path  $\geq 50$  feet between the discharge point and any property line, structure, steep slope, stream, lake, wetland, lake, or other impervious surface.
- If a dispersion trench is implemented, the vegetated flow path can be reduced to 25 feet in length; however, a vegetated flow path of  $\geq 50$  feet in length must be maintained between the outlet of the trench and any slope  $> 15\%$ .
- A maximum of 700 square feet (sf) of impervious area may drain to each concentrated flow dispersion BMP.
- Provide a pad of crushed rock (a minimum of 2 feet wide by 3 feet long by 6 inches deep) at each discharge point.
- No erosion or flooding of downstream properties may result.
- Runoff discharged towards landslide hazard areas must be evaluated by a licensed engineer in the state of Washington with geotechnical expertise or licensed geologist. The discharge point shall not be placed on or above slopes  $> 6H:1V$  or above erosion hazard areas without evaluation by a licensed engineer in the state of Washington with geotechnical expertise or licensed geologist and approval by the local jurisdiction.
- For sites with septic systems, the discharge point should be downgradient of the drain field primary and reserve areas ([WAC 246-272A-0210](#)). This requirement may be waived by the local jurisdiction if site topography clearly prohibits flows from intersecting the drain field.

## **Flows to Be Dispersed**

- Dispersion areas should be suited to handle stormwater from tributary areas so that ideally there is no runoff leaving the dispersion area.
- When modeling the hydrology of the project site (see [Chapter 4 - Hydrologic Analysis and Design](#)), treat dispersion areas and their contributing areas as disconnected from the project site because they do not contribute flow to other flow control BMPs.

## **Siting Criteria**

The key to dispersion is having vegetative land cover with a good established root zone where the roots, organic matter, and soil macroorganisms provide macropores to reduce surface compaction and prevent soil pore sealing. The vegetative cover also provides filtration and maintains sheet flow, reducing the chance for erosion. Dispersion areas must be protected from future development.

The following areas are considered appropriate candidates for dispersion because they are likely to retain these vegetative conditions over the long term:

- Publicly owned rights-of-way
- Protected beautification areas
- Agricultural areas

- State parks
- Commercial or government-owned forest lands
- Rural areas with zoned densities of less than one dwelling unit per 5 acres

**Note:** Though dispersion areas should be adjacent to the project site, they do not have to be immediately adjacent to the length of the tributary surface areas (e.g., roadway or driveway).

Dispersion areas should have the following attributes:

- Well vegetated, with established root zones
- Average longitudinal slope of  $\leq 6H:1V$
- Average lateral slope of  $\leq 6H:1V$  for both the roadway or other driveway side slope and the natural area to be part of the dispersion area
- Average lateral slope of  $\leq 3H:1V$  where a level spreader is located immediately upstream of the dispersion area
- Infiltrative soil properties that are verified by a licensed professional

Dispersion areas should have a separation of  $\geq 3$  feet between the existing ground elevation and the average annual maximum ground water elevation. This separation depth requirement applies to the entire limits of the dispersion area. There should be no discernible continuous flow paths through the dispersion area.

When selecting dispersion areas, determine whether there are ground water management plans for the area and contact the local water purveyors to determine whether the project lies within a wellhead or ground water protection zone, septic drain fields, or aquifer recharge area. These areas typically restrict stormwater infiltration; however, the local jurisdiction may waive this requirement.

**Intent:** Dispersion areas are not likely to have a uniform slope across their entire area. As a result, there are ponding areas and uneven terrain. Minor channelization of flow within the dispersion area is expected. However, a continuous flow path through the entire dispersion area disqualifies its use as a BMP because channelized flow promotes erosion of the channel that carries the flow and greatly reduces the potential for effective pollutant removal and peak flow attenuation.

### **Setback Requirements**

Dispersion areas can extend beyond public right-of-way provided that documentation on right-of-way plans ensures (via easements or agreements) the dispersion area is not developed in the future. Set dispersion areas back  $\geq 100$  feet from drinking water wells, septic tanks or drain fields, and springs used for public drinking water supplies. Ensure dispersion areas upgradient of drinking water supplies and within the 1-, 5-, and 10-year time of travel zones comply with the Washington State Department of Health (DOH) requirements ([DOH, 2010](#)).

Check with the local jurisdiction for additional setback requirements.

If the project significantly increases flows to off-site properties, determine whether a drainage easement is needed and obtain if so.

## **Construction Criteria**

- For installation of dispersal BMPs and conveyance systems near dispersion areas, minimize the area that needs to be cleared or grubbed. Maintaining plant root systems is important for dispersion areas.
- Do not compact the area around dispersion areas.
- To the maximum extent practicable, use low-ground-pressure vehicles and equipment during construction.

## **Operation and Maintenance Criteria**

See the operation and maintenance criteria in [Appendix 6-A: Recommended Maintenance Criteria for Flow Control BMPs](#) and the criteria below for maintenance access roads and signage.

### **Maintenance Access Roads (Access Requirements)**

Consider maintenance pullout areas to promote successful maintenance practices at dispersion areas. Make sure pullout areas are large enough to accommodate a typical maintenance vehicle.

### **Signage**

Physically mark the limits of the dispersion area in the field (during and after construction). Signage ensures the dispersion area is protected from construction activity disturbance and is adequately protected by measures provided in the Construction Stormwater Pollution Prevention Plan (SWPPP).

Signage helps ensure the dispersion area is not cleared or disturbed after the construction project.

## **BMP F6.41: Sheet Flow Dispersion**

Sheet flow dispersion is the simplest method of runoff control. This BMP can be used for any impervious or pervious surface that is graded to avoid concentrating flows. Because flows are already dispersed as they leave the surface, they need only traverse a narrow band of adjacent vegetation for effective attenuation and treatment.

There are two types of sheet flow dispersion: natural and engineered. Natural sheet flow dispersion uses existing soils, vegetation, and topography to disperse runoff into the surrounding landscape. Engineered sheet flow dispersion is similar to natural dispersion but uses newly developed dispersion areas with engineered soils to disperse runoff.

Sheet flow dispersion (including natural and engineered) is not subject to Underground Injection Control (UIC) regulations (see [5.6 Subsurface Infiltration \(Underground Injection Control Wells\)](#)).

### ***Applications and Limitations***

Flat or moderately sloping (< 15% slope) impervious surfaces such as roads, driveways, sport courts, patios, and roofs without gutters; sloping cleared areas that consist of bare soil, nonnative landscaping, lawn, and/or pasture; or any situation where concentration of flows can be avoided.

### General Criteria for Natural Sheet Flow Dispersion

- A 2-foot-wide transition zone to discourage channeling should be provided between the edge of the driveway pavement and the downslope vegetation, or under building eaves. This may be an extension of subgrade material (crushed rock), modular pavement, drain rock, or other material acceptable to the local jurisdiction.
- No erosion or flooding of downstream properties may result.
- Runoff discharge toward landslide hazard areas must be evaluated by a licensed engineer in the state of Washington with geotechnical expertise or a licensed geologist. The discharge point may not be placed on or above slopes > 20% or above erosion hazard areas without evaluation by a licensed engineer in the state of Washington with geotechnical expertise or a licensed geologist and approval by the local jurisdiction.
- For sites with septic systems, the discharge point must be downgradient of the drain field primary and reserve areas. This requirement may be waived by the local jurisdiction if site topography clearly prohibits flows from intersecting the drain field.
- Ensure the sheet flow path leading to the dispersion area is < 150 feet. The sheet flow path is measured in the direction of flow and generally represents the width of the pavement area.
- Do not count pervious shoulders and side slopes in determining the sheet flow path.
- Ensure the longitudinal length of the dispersion area is equivalent to the longitudinal length of tributary drainage area that is contributing sheet flow.
- Ensure the resultant slope from the contributing pavement is ≤ 9.4%, calculated using [Equation 6.8: Sheet Flow Dispersion Slope from Contributing Pavement](#):

### Equation 6.8: Sheet Flow Dispersion Slope from Contributing Pavement

$$S_{CFS} \leq (G^2 + e^2)^{0.5}$$

where:

$S_{CFS}$  = resultant slope of the lateral and longitudinal slopes (%)

e = lateral slope (superelevation) (%)

G = longitudinal slope (grade) (%)

Dispersion areas should have a separation of ≥ 3 feet between the existing ground elevation and the average annual maximum ground water elevation. This separation depth requirement applies to the entire limits of the dispersion area. There should be no discernible continuous flow paths through the dispersion area.

When selecting dispersion areas, determine whether there are ground water management plans for the area and contact the local water purveyors to determine whether the project lies within a wellhead or ground water protection zone, septic drain fields, or aquifer recharge area. These areas typically restrict stormwater infiltration; however, the local jurisdiction may waive this requirement.

**Intent:** Dispersion areas are not likely to have a uniform slope across their entire area. As a result, there are ponding areas and uneven terrain. Minor channelization of flow within the dispersion area is expected. However, a continuous flow path through the entire dispersion area disqualifies its use as a BMP because channelized flow promotes erosion of the channel that carries the flow and greatly reduces the potential for effective pollutant removal and peak flow attenuation.

### **Flows to Be Dispersed**

Dispersion areas should be suited to handle stormwater runoff from tributary areas so that ideally there is no runoff leaving the dispersion area.

### **Siting Criteria**

See the siting criteria for [BMP F6.40: Concentrated Flow Dispersion](#).

### **Setback Requirements**

See the setback requirements for [BMP F6.40: Concentrated Flow Dispersion](#).

### **Level Spreaders and Energy Dissipaters**

Where gravel level spreaders are not located between the flow contributing area and the dispersion area, side slopes leading to dispersion areas should be  $\leq 25\%$  (4H:1V). Side slopes that are 25% to 15% (7H:1V) should not be considered part of the dispersion area. Slopes  $> 25\%$  are allowed if the existing side slopes are well vegetated and show no signs of erosion problems. See the latest version of the WSDOT HRM.

Where gravel level spreaders are located between the flow contributing area and the dispersion area, consider flow contributing area side slopes  $\leq 33\%$  part of the dispersion area if existing side slopes are well vegetated and show no signs of erosion problems ([WSDOT, 2011](#)). See the latest version of the WSDOT HRM.

For any existing slope that will lead to a dispersion area, if evidence of channelized flow (rills or gullies) is present, use a flow-spreading device before those flows are allowed to enter the dispersion area.

### ***General Criteria for Engineered Sheet Flow Dispersion***

The general criteria for engineered sheet flow dispersion for Type A, B, C, and D soils are the same as described for natural sheet flow dispersion, with the following exceptions:

- Where gravel level spreaders are not located between the roadway and dispersion area, roadway side slopes leading to engineered dispersion areas should be  $\leq 25\%$  (4H:1V). Roadway side slopes that are 25% to 15% (7H:1V) should not be considered part of the dispersion area. Roadway slopes  $> 25\%$  are allowed if the existing side slopes are well vegetated and show no signs of erosions problems. For any existing slope that will lead to an engineered dispersion area, if evidence of channelized flow (rills or gullies) is present, use a flow-spreading device before those flows are allowed to enter the dispersion area.
- Roadway side slopes that are  $\leq 15\%$  are considered part of the dispersion area if the

engineered dispersion practices are applied to the slope (6.5 feet of compost-amended side slope width mitigates 1 foot of impervious surface). Roadway side slopes  $\leq 33\%$  are considered part of the dispersion area if a gravel level spreader is located between the roadway and the dispersion area.

## **Design Procedure**

The size of the dispersion area depends on the flow contributing area and the predicted rates of water loss through the dispersion system. Ensure that the dispersion area is sufficient to dispose of the runoff through infiltration, evaporation, transpiration, and/or soil absorption.

There are three options that can be applied to size sheet flow dispersion areas, as follows:

- Option 1 – Based on Simplified Equation
- Option 2 – Based on Soil Characteristics
- Option 3 – Based on Contributing Area

### **Option 1 – Based on Simplified Equation**

This option is based on a simplified equation that was derived from a water balance model ([WSDOT, 2005](#)). This equation takes into account the roadway or driveway width, saturated hydraulic conductivity, and rainfall intensity to derive the width needed for dispersion.

### **Equation 6.9: Sheet Flow Dispersion Simplified Equation**

$$W_d = \frac{W_r}{\left[\left(\frac{K_s}{r_i}\right) - 1\right]}$$

where:

$w_d$ =width of the dispersion (feet)

$w_r$ =width of the roadway or driveway (feet)

$K_{sat}$ =saturated hydraulic conductivity (in/hr) (see [6.3.3 General Criteria for Infiltration BMPs](#))

$r_i$ =rainfall intensity (in/hr)

The  $K_s/r_i$  ratio must be  $> 2$  for dispersion to have a viable benefit. If the ratio is  $\leq 1$ , the equation is not valid and will result in negative values.

### **Calculating Rainfall Intensity**

The rainfall intensity ( $r_i$ ) is the peak 5-minute intensity of the 6-month, 3-hour short-duration storm. To calculate  $r_i$ , multiply the precipitation depth (2-year, 2-hour) by the peak intensity factor based on the mean annual precipitation (MAP) for the area. Use [Table 6.9: Peak Intensity Factors for Calculating Rainfall Intensity](#) to convert the MAP value to PIF.

### **Equation 6.10: Rainfall Intensity (Sheet Flow Dispersion)**

$$r_i = P_{2yr2hr} * PIF$$

where:

$r_i$  = rainfall intensity (in/hr)

$P_{2yr2hr}$  = 2-year, 2-hour precipitation (inches)

PIF = peak intensity factor (unitless)

**Table 6.9: Peak Intensity Factors for Calculating Rainfall Intensity**

Climate Region	Mean Annual Precipitation (inches)	Isopluvial to Peak Intensity Factor
2	6–8	1.85
	8–10	1.88
	10–12	1.94
2–3	12–16	2.00
3	16–22	2.03
1–4	22–28	2.09
	28–40	2.12
	40–60	2.19
	60–120	2.25

**For more information:** The 2-year, 2-hour precipitation depth information can be found in [Figure 4.6: 2-Year, 2-Hour Isopluvial Map](#).

### Example

- Spokane 2-year, 2-hour precipitation = 0.48 inches
- Spokane MAP depth = 18 inches
- Spokane PIF for 18 inches = 2.03 inches per hour (in/hr)
- Calculate  $r_i = 0.48 \text{ in} * 2.03 \text{ in/hr} = 0.97 \text{ in/hr}$

### Option 2 – Based on Soil Characteristics

The following criteria are specific to sheet flow dispersion on all Type A and some Type B soils on slopes  $\leq 15\%$  (depending on saturated hydraulic conductivity rates):

- For saturated hydraulic conductivity rates (see [6.3.3 General Criteria for Infiltration BMPs](#)) of  $\geq 4 \text{ in/hr}$  and for the first 20 feet (along the sheet flow path) of impervious surface that drains to the dispersion area, there must be 10 lateral feet of dispersion area width. For each additional foot of impervious surface (along the sheet flow path) that drains to the dispersion area, provide 0.25 lateral feet of dispersion area.

- For dispersion areas that receive sheet flow from only disturbed pervious areas (bare soil and nonnative landscaping), for every 6 feet (along the sheet flow path) of disturbed pervious area, provide 1 lateral foot width of dispersion area.

The following criteria are specific to sheet flow dispersion on all Type C and D soils and some Type B soils with saturated hydraulic conductivity rates of  $\leq 4$  in/hr on slopes  $\leq 15\%$ :

- For every 1 foot of contributing pavement width, provide a dispersion area width of 6.5 feet.
- The dispersion area should have a minimum width of native vegetation of 100 feet (measured in the direction of the flow path).

### **Option 3 – Based on Contributing Area and Slope**

- A vegetated buffer width of 10 feet of vegetation must be provided for up to 20 feet of width of paved or impervious surface. An additional 5 feet of width must be added for each additional 20 feet of width or fraction thereof.
- A vegetated buffer width of 25 feet of vegetation must be provided for up to 150 feet of contributing cleared area (i.e., bare soil, nonnative landscaping, lawn, and/or pasture).
- Slopes within the 10- or 25-foot minimum flow path through vegetation should be no steeper than 8%. If this criterion cannot be met due to site constraints, the 10- or 25-foot flow path length must be increased 1.5 feet for each 1% increase in slope above 8%.
- [Figure 6.31: Sheet Flow Dispersion for Driveways for Option 3](#) shows two possible ways of achieving sheet flow dispersion for driveways.

### ***Construction Criteria***

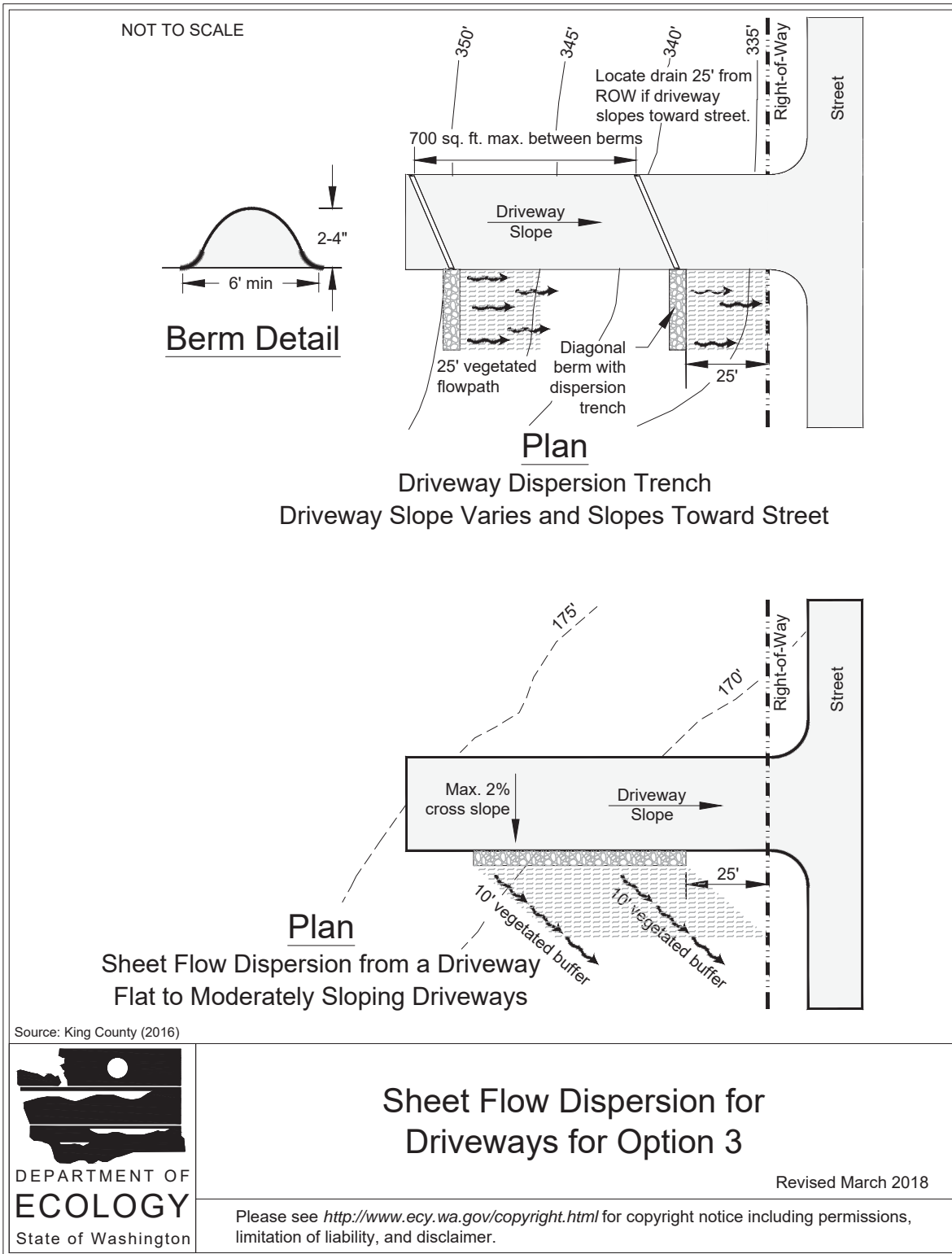
See the construction criteria for [BMP F6.40: Concentrated Flow Dispersion](#).

### ***Operation and Maintenance Criteria***

See the operation and maintenance criteria for [BMP F6.40: Concentrated Flow Dispersion](#).



**Figure 6.31: Sheet Flow Dispersion for Driveways for Option 3**



## **BMP F6.42: Full Dispersion**

This BMP allows for “fully dispersing” runoff from impervious surfaces and cleared areas of commercial and residential development sites that protect a portion of the site (or for large sites, a portion of an area within a subbasin drainage on the site) in a natural, native vegetation cover condition. Natural vegetation is preserved and maintained in accordance with guidelines. Runoff from roofs, driveways, and roads within the development is dispersed within the site by using the areas of preserved vegetation.

**Note:** Full dispersion is not subject to Underground Injection Control (UIC) regulations. However, [Figure 6.32: Standard Dispersion Trench With Notched Grade Board](#) shows a standard dispersion trench that is subject to UIC regulations; see [5.6 Subsurface Infiltration \(Underground Injection Control Wells\)](#).

### ***Applications and Limitations***

This BMP is primarily intended for areas of new development. A sliding scale for the amount of preserved vegetated area is provided to allow application to other sites.

- Up to 10% of the site that is impervious surface can be rendered ineffective impervious area by dispersing runoff from it into the native vegetation area. Any additional impervious areas (this BMP recommends limiting additional impervious areas to < another 10% for rural areas) are considered effective impervious surfaces with the exception of roofs served by drywells.
- Types of development that retain a percentage of the site (or for large sites, a portion of an area within a subbasin drainage on the site) in a natural forested or other native vegetation cover condition may also use these BMPs to avoid triggering the flow control BMP requirement or to minimize its use at the site.

### ***General Criteria***

Impervious areas of residential developments can meet flow control requirements by distributing runoff into native vegetation areas that meet the limitations and design guidelines below if the ratio of impervious area to native vegetation area does not exceed 15%. Vegetation must be preserved and maintained according to the following requirements:

- The preserved area should be situated to minimize the clearing of existing native vegetation, to maximize the preservation of wetlands, and to buffer stream corridors.
- The preserved area should be placed in a separate tract or protected through recorded easements for individual lots.
- If feasible, the preserved area should be located downslope from the building sites, since flow control and water quality are enhanced by flow dispersion through undisturbed soils and native vegetation.
- The preserved area should be shown on all property maps and should be clearly marked during clearing and construction on the site.
- Vegetation and trees should not be removed from the natural growth retention area, except for the removal of dangerous and diseased trees.

## Design Procedure

The amount of vegetation that must be preserved and maintained for full dispersion is based on a “sliding scale” that varies between 20% and 65% depending on the percentage of the site with impervious surface that drains into the native vegetation area, as shown in [Table 6.10: Percentage of Site With Undisturbed Native Vegetation Versus Percentage of Site With Impervious Surface Draining to Areas of Preserved Native Vegetation](#).

**Table 6.10: Percentage of Site With Undisturbed Native Vegetation Versus Percentage of Site With Impervious Surface Draining to Areas of Preserved Native Vegetation**

Percentage of Site With Impervious Surface Draining to Native Vegetation Area	Percentage of Site With Undisturbed Native Vegetation
10.0	65
9.0	60
8.25	55
7.5	50
6.75	45
6.0	40
5.25	35
4.5	30
3.75	25
3.0	20

### Roof Downspouts

Roof surfaces that are connected to drywells are considered “fully dispersed” provided that they are designed according to local requirements. Otherwise, the roof runoff is assumed to run into the street, and that volume must be added to the volume dispersed in the roadway dispersion component of this BMP.

### Driveway Dispersion

Driveway surfaces are considered to be “fully dispersed” if the site meets the required ratio of impervious surfaces to preserved native vegetation above, and if they comply with the driveway dispersion BMPs ([BMP F6.40: Concentrated Flow Dispersion](#) and [BMP F6.41: Sheet Flow Dispersion](#)) and have flow paths through native vegetation > 100 feet. This also holds true for any driveway surfaces that comply with the roadway dispersion BMPs described below.

### Roadway Dispersion BMPs

Roadway surfaces are considered to be “fully dispersed” if the site meets the required ratio of impervious surfaces to preserved native vegetation above, and if they comply with the following dispersion requirements:

- Roadway runoff dispersion is allowed only on rural neighborhood collectors and local access streets. To the extent feasible, driveways should be dispersed to the same standards as roadways to ensure adequate water quality protection of downstream resources.
- The road section shall be designed to minimize collection and concentration of roadway runoff. Sheet flow over roadway fill slopes (i.e., where roadway subgrade is above adjacent right-of-way) should be used wherever possible to avoid concentration.
- When it is necessary to collect and concentrate runoff from the roadway and adjacent upstream areas (e.g., in a ditch on a cut slope), concentrated flows shall be incrementally discharged from the ditch via cross culverts or at the ends of cut sections. These incremental discharges of newly concentrated flows shall not exceed 0.5 cubic feet per second (cfs) at any one discharge point from a ditch for the 100-year storm. Where flows at a particular ditch discharge point were already concentrated under existing site conditions (e.g., in a natural channel that crosses the roadway alignment), the 0.5 cfs limit would be in addition to the existing concentrated peak flows.
- Ditch discharge points with up to 0.2 cfs discharge for the 100-year storm shall use rock pads or dispersion trenches to disperse flows. Ditch discharge points with between 0.2 and 0.5 cfs discharge for the 100-year storm shall use only dispersion trenches to disperse flows.
- Dispersion trenches shall be designed to accept surface flows (free discharge) from a pipe, culvert, or ditch end, shall be aligned perpendicular to the flow path, and shall be minimum 2 by 2 feet in section, 50 feet in length, filled with 0.75- to 1.5-inch washed rock, and provided with a level notched grade board (see [Figure 6.32: Standard Dispersion Trench With Notched Grade Board](#)). Manifolds may be used to split flows up to 2 cfs discharge for the 100-year storm between up to four trenches. Dispersion trenches shall have a minimum spacing of 50 feet.
- After being dispersed with rock pads or trenches, flows from ditch discharge points must traverse a minimum of 100 feet of undisturbed native vegetation before leaving the project site, or entering an existing on-site channel carrying existing concentrated flows across the road alignment.

**Note:** In order to provide the 100-foot flow path length to an existing channel, some roadway runoff may unavoidably enter the channel undispersed. Also note that water quality treatment may be waived for roadway runoff dispersed through 100 feet of undisturbed native vegetation.

- Flow paths from adjacent discharge points must not intersect within the 100-foot flow path lengths, and dispersed flow from a discharge point must not be intercepted by another discharge point. To enhance the flow control and water quality effects of dispersion, the flow path shall be  $\leq 15\%$  slope, and shall be located within designated open space.

**Note:** Runoff may be conveyed to an area meeting these flow path criteria.

- Ditch discharge points shall be located a minimum of 100 feet upgradient of steep slopes (i.e.,

slopes > 40%), wetlands, and streams.

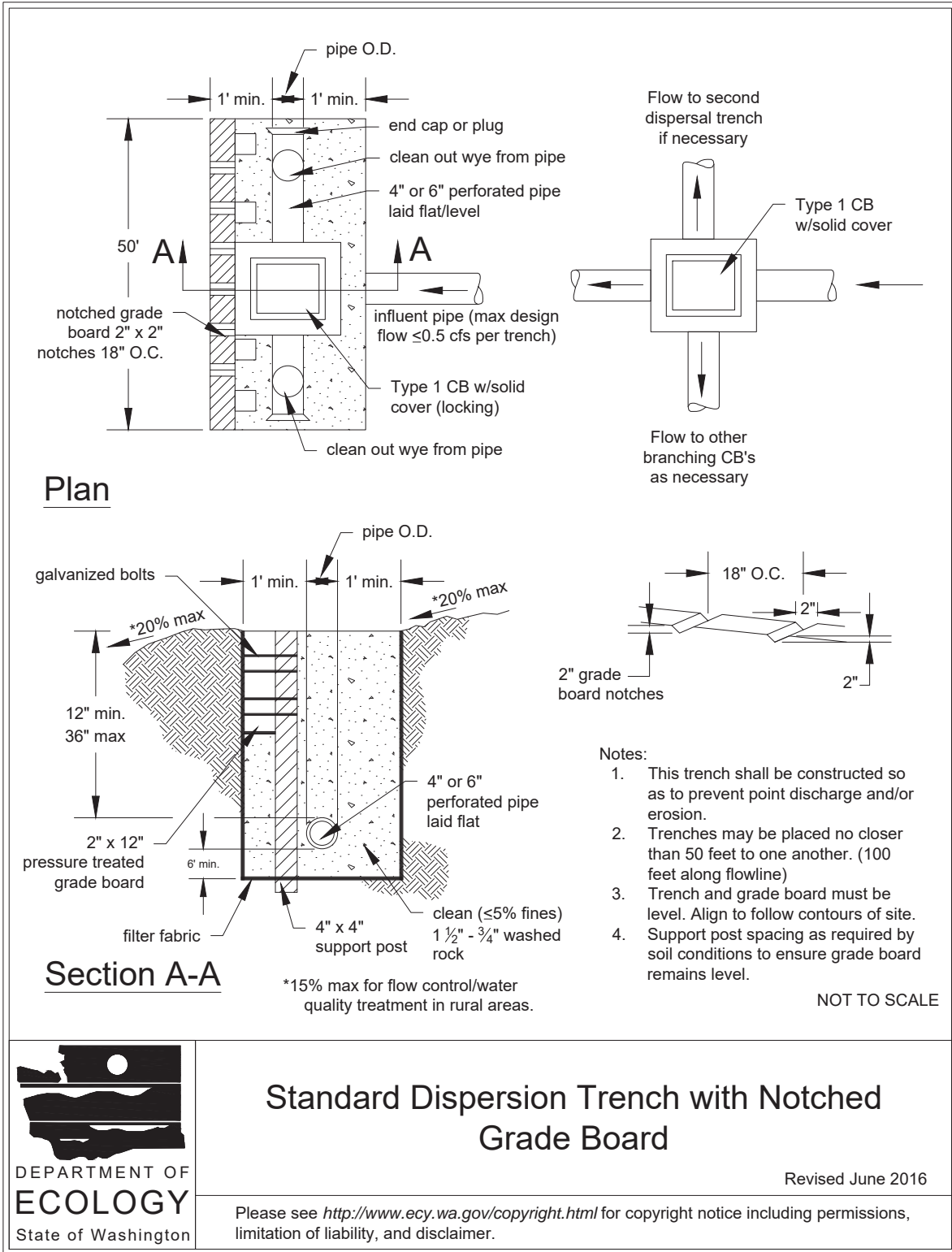
- Where the local jurisdiction determines there is a potential for significant adverse impacts downstream (e.g., erosive steep slopes or existing downstream drainage problems), dispersion of roadway runoff may not be allowed, or other measures may be required.

### **Cleared Area Dispersion BMPs**

The runoff from cleared areas that consist of bare soil, nonnative landscaping, lawn, and/or pasture is considered to be “fully dispersed” if it is dispersed through  $\geq 25$  feet of native vegetation in accordance with the following criteria:

- The contributing flow path of cleared area being dispersed must be  $\leq 150$  feet.
- Slopes within the 25-foot-minimum flow path through native vegetation should be  $\leq 8\%$ . If this criterion cannot be met due to site constraints, the 25-foot flow path length must be increased 1.5 feet for each 1% increase in slope above 8%.

**Figure 6.32: Standard Dispersion Trench With Notched Grade Board**



## **Construction Criteria**

See the construction criteria for [BMP F6.40: Concentrated Flow Dispersion](#).

## **Operation and Maintenance Criteria**

See the operation and maintenance criteria for [BMP F6.40: Concentrated Flow Dispersion](#).

## **BMP F6.43: Channelized Flow Dispersion**

This BMP redisperses influent channelized flows to natural or engineered dispersion areas.

### **General Criteria**

Channelized flow dispersion criteria for all soil types are summarized below.

#### **Flows to Be Dispersed**

Dispersion areas should be suited to handle stormwater runoff from tributary areas so that ideally there is no runoff leaving the dispersion area.

#### **Siting Criteria**

See the siting criteria for [BMP F6.40: Concentrated Flow Dispersion](#).

#### **Setback Requirements**

See the setback requirements for [BMP F6.40: Concentrated Flow Dispersion](#).

#### **Redispersion Design Criteria**

Flows collected in a pipe or ditch conveyance system require energy dissipation and dispersal at the end of the conveyance system before entering the dispersion area. See [Figure 6.32: Standard Dispersion Trench With Notched Grade Board](#) for a typical detail for flow dispersion trench. Guidance for the design of energy dissipaters can be found in *Hydraulic Design of Energy Dissipators for Culverts and Channels* ([FHWA, 2006](#)) and in the latest version of the WSDOT *Hydraulics Manual*.

Concentrated runoff from the flow contributing area and adjacent upstream areas (such as in a ditch or cut slope) must be incrementally discharged from the conveyance system (e.g., ditch, gutter, or storm drain) via cross culverts or at the ends of cut sections. These incremental discharges of newly concentrated flows must not exceed 0.5 cubic feet per second (cfs) at any single discharge point from the conveyance system for the 100-year design flow (see hydrologic modeling methods in [Chapter 4 - Hydrologic Analysis and Design](#)). Where flows at a particular discharge point are already concentrated under existing site conditions (for example, in a natural channel that crosses a roadway alignment), the 0.5 cfs limit would be in addition to the existing concentrated peak flows.

Discharge points with up to 0.2 cfs discharge for the 100-year design flow may use rock pads or dispersion trenches to disperse flows. Discharge points with between 0.2 and 0.5 cfs discharge for the 100-year design flow must use only dispersion trenches to disperse flows.

Design dispersion trenches to accept surface flows (free discharge) from a pipe, culvert, or ditch end; aligned perpendicular to the flow path; a minimum of 2 by 2 feet in section; 50 feet in length; filled with 0.75- to 1.5-inch-diameter washed rock; and provided with a level notched grade board (see [Figure 6.32: Standard Dispersion Trench With Notched Grade Board](#)). Use manifolds to split flows up to 2 cfs discharge for the 100-year peak flow between four trenches (maximum). Provide a minimum spacing of 50 feet for dispersion trenches.

After being dispersed with rock pads or trenches, flows from discharge points must traverse the required flow path length of the dispersion area before entering an existing on-site channel carrying existing concentrated flows away from the roadway alignment.

**Note:** To provide the required flow path length to an existing channel, some roadway runoff may unavoidably enter the channel undispersed.

Do not allow flow paths from adjacent discharge points to intersect within the required flow path lengths, and ensure dispersed flow from a discharge point is not intercepted by another discharge point.

Locate ditch discharge points a minimum of 100 feet upgradient of steep slopes (slopes > 40% within a vertical elevation change of  $\geq 10$  feet), wetlands, and streams.

Where the local jurisdiction determines that there is a potential for significant adverse impacts downstream (such as erosive steep slopes or existing downstream drainage problems), dispersion of roadway runoff may not be allowed, or other measures may be required.

### **Level Spreaders and Energy Dissipaters**

Where gravel level spreaders are not located between the flow contributing area and the dispersion area, side slopes leading to natural dispersion areas should be  $\leq 25\%$  (4H:1V). Side slopes that are 25% to 15% (7H:1V) should not be considered part of the dispersion area. Slopes > 25% are allowed if the existing side slopes are well vegetated and show no signs of erosion problems. See latest version of the WSDOT HRM.

Where gravel level spreaders are located between the flow contributing area and the dispersion area, consider flow contributing area side slopes  $\leq 33\%$  part of the natural dispersion area if existing side slopes are well vegetated and show no signs of erosion problems ([WSDOT, 2011](#)). See latest version of the WSDOT HRM.

For any existing slope that will lead to a natural dispersion area, if evidence of channelized flow (rills or gullies) is present, use a flow-spreading device before those flows are allowed to enter the dispersion area.

## ***Design Procedure***

### **Natural Channelized Flow Dispersion**

The following criterion is specific to channelized flow dispersion that discharged on slopes  $\leq 15\%$  to all Type A and some Type B soils, depending on saturated hydraulic conductivity rates.

- For saturated hydraulic conductivity rates ( $K_{sat}$ , as determined in [6.3.3 General Criteria for Infiltration BMPs](#)) of 4 inches per hour (in/hr) or greater, the dispersion area should be  $\geq 50\%$



of the tributary drainage area.

The following criteria are specific to channelized flow dispersion that discharged on slopes  $\leq 15\%$  to all Type C and D soils and some Type B soils, depending on saturated hydraulic conductivity rates.

- For every 1 foot of contributing pavement width, a dispersion area width of 6.5 feet is needed.
- The dispersion area should have a minimum width of native vegetation of 100 feet, measured in the direction of the flow path.

### **Engineered Channelized Flow Dispersion**

Engineered channelized flow dispersion criteria for Type A, B, C, and D soils are the same as described for natural channelized flow dispersion, with the following exceptions,

The following criterion is specific to engineered channelized flow dispersion on all Type A and some Type B soils on slopes  $\leq 15\%$ , depending on saturated hydraulic conductivity rates:

- For saturated hydraulic conductivity rates of  $\geq 4$  in/hr, and for the first 20 feet (along the sheet flow path) of impervious surface that drains to the dispersion areas, there must be 10 lateral feet of dispersion area width. For each additional foot of impervious surface (along the sheet flow path) that drains to the dispersion areas, provide 0.25 lateral feet of dispersion area.

The following criteria are specific to channelized engineered dispersion on Type C and D soils and some Type B soils on slopes  $\leq 15\%$ , depending on saturated hydraulic conductivity rates:

- For every 1 foot of contributing pavement width, a dispersion area width of 6.5 feet is needed.
- The dispersion area should have a minimum width of 100 feet, measured in the direction of the flow path.

### ***Construction Criteria***

See the construction criteria for [BMP F6.40: Concentrated Flow Dispersion](#).

### ***Operation and Maintenance Criteria***

See the operation and maintenance criteria [BMP F6.40: Concentrated Flow Dispersion](#).

## **6.6 Additional Flow Control BMPs**

### **6.6.1 Purpose**

Four additional flow control BMPs are described in this section:

- [BMP F6.61: Amending Construction Site Soils](#)
- [BMP F6.62: Trees](#)
- [BMP F6.63: Vegetated Roofs](#)
- [BMP F6.64: Minimal Excavation Foundations](#)

## 6.6.2 Application

Table 6.11: [Applicability of Additional Flow Control BMPs for Runoff Treatment, Flow Control, and Conveyance](#) summarizes the applicability of detention BMPs for runoff treatment, flow control, and conveyance.

**Table 6.11: Applicability of Additional Flow Control BMPs for Runoff Treatment, Flow Control, and Conveyance**

BMP	Runoff Treatment					Flow Control	Conveyance
	Pretreatment	Basic	Metals	Oil Control	Phosphorus		
<a href="#">BMP F6.61: Amending Construction Site Soils</a>						✓	
<a href="#">BMP F6.62: Trees</a>						✓	
<a href="#">BMP F6.63: Vegetated Roofs</a>						✓	
<a href="#">BMP F6.64: Minimal Excavation Foundations</a>						✓	

## 6.6.3 Cold Climate Considerations

Grasses or other vegetation used in vegetated roofs may also be dormant or ineffective at providing treatment mechanisms (e.g., filtration, pollutant uptake, etc.) during the winter. For vegetated BMPs, plants should be selected to be tolerant of cold and freezing climates. See [5.2.4 Cold Weather Considerations](#) for additional cold weather considerations.

## 6.6.4 Arid and Semiarid Climate Considerations

In arid/semiarid portions of eastern Washington, grasses and plants used in vegetated roofs should be selected to be drought tolerant and not require watering after establishment (2 to 3 years). In more arid environments, watering may be needed during prolonged dry periods after plants are established.

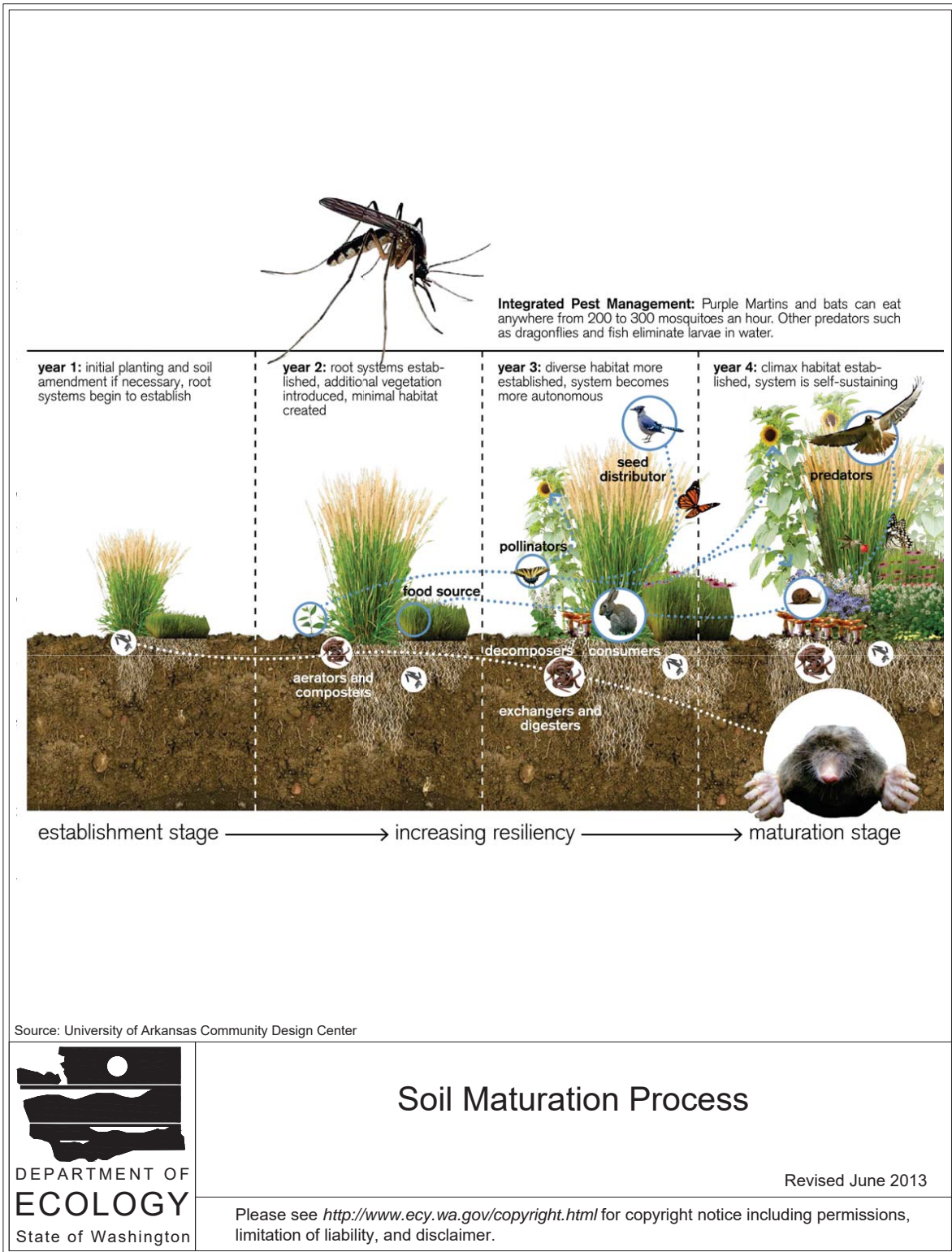
## 6.6.5 Additional BMPs for Flow Control

### BMP F6.61: Amending Construction Site Soils

Naturally occurring (undisturbed) soil and vegetation provide important stormwater functions including: infiltration; nutrient, sediment, and pollutant adsorption; sediment and pollutant filtration;

storage; and pollutant decomposition. [Figure 6.33: Soil Maturation Process](#) illustrates the typical soil maturation process over a 4-year period. These functions are largely lost when development strips away native soil and vegetation and replaces it with minimal topsoil and sod or other plantings. Not only are the stormwater benefits lost, but the landscapes themselves can become pollution-generating pervious surfaces (PGPSs) if pesticides, fertilizers, and other landscape and/or industrial/household chemicals are used for maintenance.

**Figure 6.33: Soil Maturation Process**



Installing amended soils can regain greater stormwater functions in the post-development landscape and help preserve the plant and soil system more effectively. This type of approach provides a soil/landscape system with adequate depth, permeability, and organic matter to sustain itself and to continue working as an effective stormwater infiltration system.

Amending soils to establish a minimum soil quality and depth is not the same as preservation of naturally occurring soil and vegetation. However, establishing a minimum soil quality and depth will provide improved on-site management of stormwater flow and water quality.

In addition to helping meet the requirements of [2.7.7 Core Element #6: Flow Control](#), amending construction site soils offers the following benefits:

- Amended soils can be included in designs for Natural Dispersion BMPs (see [6.5 Dispersion BMPs](#)) to improve dispersal and absorption of stormwater flows.
- Creates a medium for healthy plant growth, reducing the need for fertilizers and pesticides and peak summer irrigation needs ([Chollak, n.d.](#)).
- Can improve overall site water quality performance by promoting infiltration; increasing cation exchange capacity, pollutant adsorption, and filtration; and buffering soil pH ([USDA and USCC, 2005](#)).

## **General Criteria**

[BMP F6.61: Amending Construction Site Soils](#) can be used for all pervious areas, except for on till soils with slopes > 33%. Soil organic matter can be attained through numerous materials such as compost, composted woody material, biosolids, forest product residuals, or other locally available materials deemed suitable for this application. The materials used must be appropriate and beneficial to the plant cover to be established and must not have an excessive percentage of clay fines.

## **Design Procedure**

Design submittals for amended soils should include plans, work sheets, and specifications including the following:

- All site areas to be protected
- Soil areas to be disturbed and restored
- Any soil areas previously disturbed and intended for restoration
- Proposed site access and construction circulation routes
- Site areas intended for staging and material storage (to be restored postconstruction)
- Measures proposed to minimize compaction and restore compacted areas postconstruction
- Specific soil amendment details for all landscaped areas listed by type and use

These design submittals should be coordinated with the project's erosion and sediment control plan and Stormwater Pollution Prevention Plan. To determine the amendment requirements for disturbed soils the following general steps should be followed:

1. Visit the site to observe existing conditions.
2. Conduct soil sampling.
3. Review site grading and landscape areas.
4. Select amendments options based on soils analysis and proposed grading and landscaping plans.
5. Specify topsoil, mulch, and compost or other locally available, suitable materials to be used for amending soils.
6. Calculate quantities.

To calculate soil and amendment needs, Simple Amendment Rates or Custom Amendment Rates can be used, as described below. For both approaches, the following general design goals apply unless specified otherwise based on local conditions and plant choices:

- A target organic matter content of 6% to 8% by dry weight for all nonturf planting areas
- A target organic matter content of 3% to 5% for turf areas
- A pH between 6.0 and 8.0 or as specified for particular plant choices

Note that some experimentation may be needed to determine optimum organic matter content and best sources of materials available for amending soils in eastern Washington.

### **Simple Amendment Rates**

The simplest way to calculate soil and amendment needs is to use these preapproved rates:

- **Planting beds:** 6% to 8% organic content using 3 inches of compost amended to an 8-inch depth or a topsoil mix containing 35% to 40% compost by volume
- **Turf areas:** 3% to 5% organic matter content using 1.75 inches of compost amended to an 8-inch depth or a topsoil mix containing 20% to 25% compost by volume

### **Custom Amendment Rates**

The target organic matter content may be achieved by using the preapproved rates outlined above or by calculating a custom rate. In many instances the organic matter content of existing site soils may be relatively good, or compatible with the natural site conditions, and therefore not require as much amendment. In some instances, calculating a site-specific amendment rate may result in more efficient use of amendments and significant cost savings. This may be particularly true for large sites due to economies of scale.

A spreadsheet that performs these calculations is available on the Soils for Salmon website at the following web address:

<http://www.soilsforsalmon.org/resources.htm>

This spreadsheet allows the user to enter the following inputs:

- Soil bulk density (pound [lb]/cubic yard [cy] dry weight)
- Initial organic matter (%)
- Final target soil organic matter (%)
- Compost bulk density (lb/cy dry weight)
- Compost organic matter (%)
- Depth compost is to be incorporated (inches)

Generally, on-site soils should be tested for bulk density and initial organic matter. Based on these measurements and input goals on final target soil organic matter and compost bulk density and organic matter, the spreadsheet calculates the compost application rate (CR) to be applied (in units of inches). Another easy-to-use calculator developed by King County is available on the Achieving the Post construction Soil Standard web page:

<https://kingcounty.gov/depts/dnrp/solid-waste/compost-calculator.aspx>

CRs can be calculated using the following equation:

### **Equation 6.11: Compost Application Rate**

$$CR = D \times \frac{(SBD * (SOM\% - FOM\%))}{(SBD * (SOM\% - FOM\%) - CBD * (COM\% - FOM\%) )}$$

where:

CR = compost application rate (inches)

D = finished depth of incorporated compost (inches)

SBD = soil bulk density (lb/cy dry weight)

SOM% = initial soil organic matter (%)

FOM% = final target soil organic matter (target will be 5% or 10% depending on turf or landscape area) (%)

CBD = compost bulk density (lb/cy dry weight)

COM% = compost organic matter (%)

Compost material should be mature and derived from organic waste materials including plant debris, biosolids, or wood wastes that meet the functional requirements and intent of the organic soil amendment specification.

Compost-amended areas designed in accordance with the above guidance can be incorporated into the hydrologic analysis used to size flow control and runoff treatment BMPs as lawn/landscaped areas.

## **Construction Criteria**

Protecting and enhancing site soils requires planning ([3.D.2 LID Site Planning](#)) and sequencing of construction activities to reduce impacts. The following recommended steps are adapted from the *Low Impact Development Technical Guidance Manual for Puget Sound* ([WSU - PSP, 2012](#)) and the *Building Soil – A Foundation for Success* website (<http://www.buildingsoil.org/>). These steps begin with land clearing and grading and continue through end of construction (prior to planting) and after planting is complete:

### **Land Clearing and Grading Phase**

- Fence all vegetation and soil protection areas prior to first disturbance, and communicate those areas to clearing and grading operators. The root zones of trees that may extend into the grading zone should be protected or cut rather than ripped during grading.
- Chip land-clearing debris on-site and reuse as erosion-control cover or stockpile for reuse as mulch at end of project.
- Stockpile topsoil to be reused with a breathable cover, such as wood chips or landscape fabric.
- If amended, topsoils will be placed at end of project. Grade 8 to 12 inches below finish grade to allow for placing the topsoil.

### **Construction Phase**

- Ensure erosion and sediment control BMPs are in place before and modified after grading to protect construction activities. Compost-based BMPs (compost “blankets” for surface, and compost berms or socks for perimeter controls) give a “two-for-one” benefit because the compost can be reused as soil amendment at the end of the project.
- Lay out roads and driveways immediately after grading and place rock bases for them as soon as possible. Keep as much construction traffic as possible on the road base, and off open soils. This will improve erosion compliance, reduce soil compaction, and increase site safety by keeping rolling equipment on a firm base.
- Protect amended/restored soils from equipment-caused compaction by using steel plates or other BMPs if equipment access is unavoidable across amended soils.
- Maintain vegetation and soil protection area barriers and temporary tree root zone protection BMPs throughout construction and ensure that all contractors understand their importance.

### **End of Construction, Soil Preparation Before Planting**

- Ensure vegetation and soil protection barriers are maintained through the end of construction.
- Disturbed or graded soil areas that have received vehicle traffic will need to be decompacted to a minimum 12-inch depth. This can be done with a cat-mounted ripper or with bucket-mounted ripping teeth.
- Amend all disturbed areas with compost or other specified amendments  $\geq$  8 inches deep by



tilling, ripping, or mixing with a bucket loader. Alternatively, place amended stockpiled topsoil or import an amended topsoil. It is good practice to scarify or mix amended soils several inches into the underlying subsoil to enhance infiltration and root penetration. Compost from erosion BMPs (compost blankets, berms, or socks) can be reused as appropriate if immediately followed by planting and mulching so there is no lapse in erosion control.

- Amended topsoil can be placed as soon as building exterior work is complete. During this step, vehicles should stay on roads and driveway pads. Compost, soil blends provide good ongoing erosion protection.
- Avoid tilling through tree roots – instead use shallow amendment and mulching.
- Final preparation for turf areas should include raking rocks, rolling, and possibly placing 1 to 2 inches of sandy loam topsoil before seeding or sodding.
- Plan for amended soil to settle by placing amended soil slightly higher than desired final grade, or retain or import a smaller amount of amended topsoil to meet final grades adjacent to hardscape such as sidewalks.
- Keep compost, topsoil, and mulch delivery tickets so inspector can verify that quantities and products used match those calculated for design (See Design Procedure section above).

#### **After Planting and End of Project Phase**

- Remove protection area barriers, including sediment fences, filter socks, and curb and storm drain barriers. Evaluate trees for stress and need for treatment, such as pruning, root-feeding, mulching etc. Plan to have an arborist on-site, as appropriate.
- Mulch all planting beds where soil has been amended and replanted with 2 to 3 inches of arborist wood chip or other specified mulch.
- Communicate a landscape management plan to property owners that includes: on-site reuse of organics (e.g., mulch leaves, mulch-mow grass clippings) to maintain soil health; avoiding pesticide use; and minimal organic-based fertilization.

#### ***Operation and Maintenance Criteria***

- Plant and mulch areas immediately after amending and settling soil to stabilize site as soon as possible.
- Protect amended areas from excessive foot traffic and equipment to prevent compaction and erosion.
- Remove weeds as necessary or appropriate through manual removal, tilling and/or remulching.
- Landscape management plans should continually renew organic levels through mulch-mowing on turf areas, allowing fallen leaves to remain on beds, and/or replenishing mulch layers every 1 to 2 years.
- Minimize or eliminate use of pesticides and fertilizers. Landscape management personnel should be trained to minimize chemical inputs, use nontoxic alternatives, and manage the

landscape areas to minimize erosion, recognize soil and plant health problems, and optimize water storage and soil permeability.

**For more information:** See [Appendix 6-A: Recommended Maintenance Criteria for Flow Control BMPs](#) for additional maintenance recommendations for this BMP.

## **BMP F6.62: Trees**

Trees provide a broad range of environmental, aesthetic, and economic benefits. ([McPherson et al., 2005](#)) found that the benefits from trees, including energy conservation, air quality, carbon sequestration, increased property values, and stormwater management, significantly outweighed the costs of installation and maintenance.

Mature, healthy trees can play a significant role in reducing stormwater runoff by intercepting and storing precipitation, promoting evapotranspiration, and slowly releasing intercepted precipitation from foliage and branches to the surrounding soil. The root systems of trees also serve to penetrate soil, build soil structure, and provide conduits for infiltration.

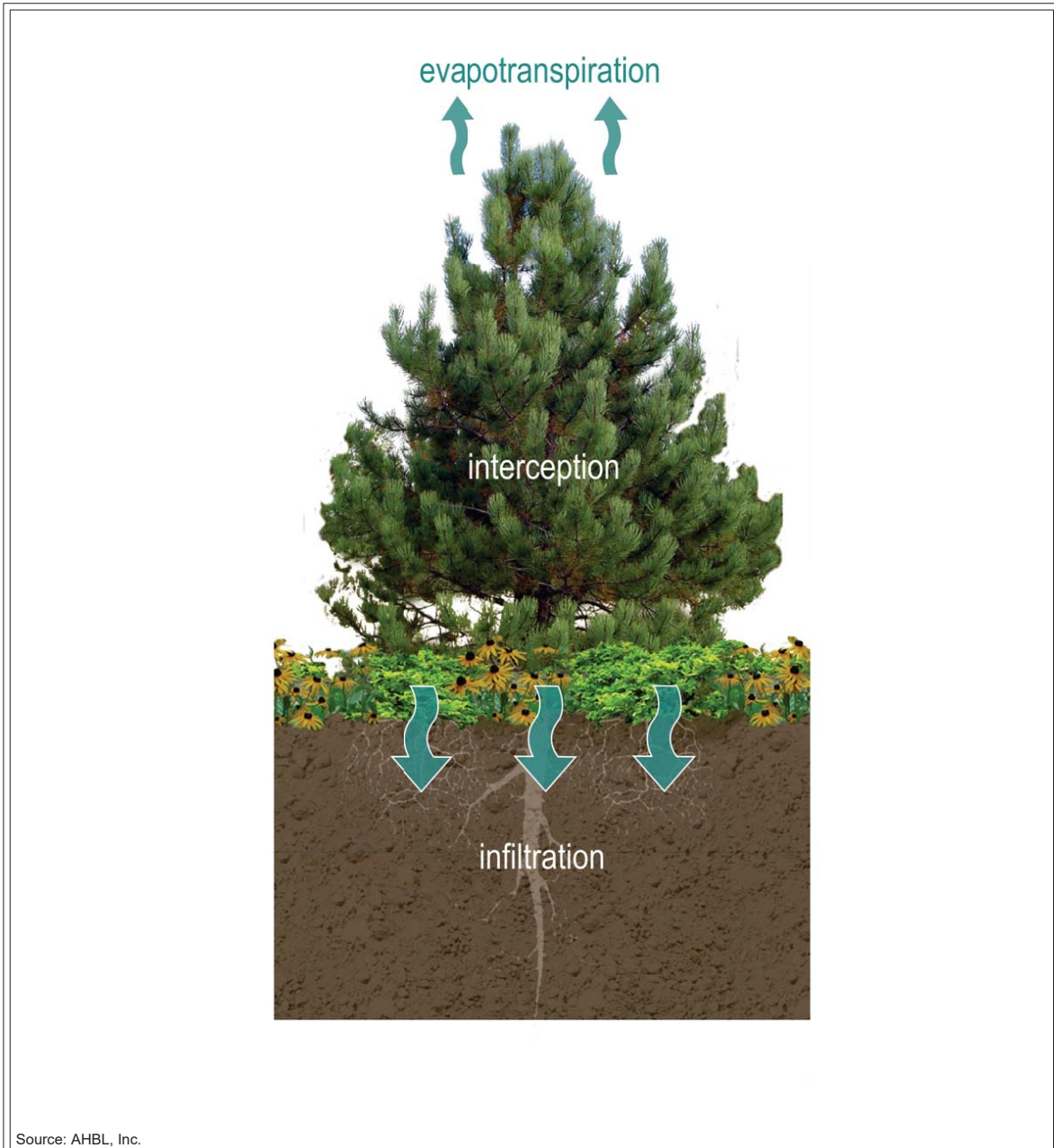
[Appendix 5-B: Planting Recommendations](#) includes a list of trees appropriate for eastern Washington. Engaging qualified designers (landscape architects, certified arborists) at the early stages of design is important for success.

### ***Applications***

Applications and limitations for individual retained or planted trees on developed sites include the following:

- Properly planted new and existing trees can intercept precipitation and reduce associated surface flow on streets, parking lots, sidewalks, and plaza areas (see [Figure 6.34: Illustration of How a Tree Can Intercept and Infiltrate Stormwater](#)).
- Tree crown growth can be restricted by adjacent structure or overhead utilities.
- Inadequate underground rooting space can impair growth and cause premature mortality ([Lindsay and Bussuk, 1992](#)), ([Grabosky and Gilman, 2004](#)).
- Adequate soil volume and quality are needed for trees to reach a healthy mature size.
- Trees surrounded by or located near impervious surfaces can experience limited soil moisture, nutrients and gas exchange.
- Larger mature trees provide more stormwater (and other) benefits than small trees.
- Appropriate drainage is needed to ensure the growth of healthy trees ([Urban, 2008](#)).
- Trees should be protected when located near plowed snow storage areas.

**Figure 6.34: Illustration of How a Tree Can Intercept and Infiltrate Stormwater**



Source: AHBL, Inc.



### Illustration of How a Tree Can Intercept and Infiltrate Stormwater

Revised June 2013

Please see <http://www.ecy.wa.gov/copyright.html> for copyright notice including permissions, limitation of liability, and disclaimer.

## **General Criteria**

There are numerous tree species appropriate for eastern Washington with conditions ranging from sustained temperatures over 100 degrees in the summer to severe winter winds and cold weather. Successful planning where extreme growing conditions occur is essential. Absolute cold is not so much the problem as are drying winds that dehydrate plants growing in frozen soils. Wind protection, mulching, appropriate soil structure and careful late-autumn watering helps facilitate healthy tree growth in areas of extreme weather.

While cold is not an insurmountable challenge, snow storage in the immediate vicinity of trees could create problems if the selected trees were not adapted to heavy snow conditions. Whether along roadways, urban streets, or parking areas, appropriate site planning for adequate snow storage can play an important role in maintaining the health of trees and planting areas.

Preparation for tree planting in eastern Washington is particularly important as most tree nursery stock is obtained from nurseries located in the mild climates of western Oregon and Washington. Preparation of tree planting holes and the specification of appropriate planting topsoil are of the utmost importance. ([Urban, 2008](#)) recommends a minimum depth for planting soil of 30 to 48 inches. See additional soil depth and volume discussion below.

## **Site Assessment and Planning**

Planting and retaining healthy trees requires space and investment. Realizing the substantial benefits of mature trees requires engaging the designer from planning through construction phases, whether new construction or a retrofit. Site assessment to inform soil strategies and species selection is important for healthy tree growth and to reduce potential problems with competing uses. The initial site assessment for location and type of tree should include the following:

- Available aboveground growing space
- Available belowground root space and ground-level planting area relative to pavement, buildings, and utilities
- Type of soil and availability of water
- Overhead obstructions
- Vehicle and pedestrian sight lines
- Proximity to paved areas and underground structures
- Proximity to property lines, buildings, and other vegetation
- Prevailing wind direction and sun exposure
- Maintenance
- Slope and topographic features
- Proximity to snow storage areas
- Lists of required and prohibited local trees

Additional environmental, economic, and aesthetic functions, such as shade (reduced heat island effect), windbreak, privacy screening, air quality, and increased property value should also be considered when determining the use, type, and placement of trees.

Many of the key decisions for designing with trees in eastern Washington depend on existing soil conditions. Soil analysis for trees should include: understanding historical uses, extent and result of disturbances, soil texture, compaction, permeability, barriers and interfaces in the soil profile, and chemical characteristics ([Urban, 2008](#)). Urban soils are often degraded from construction activities. If the existing soil or structural soils are used as the planting material, particular attention should be given to soil pH, which is often high due to concrete/construction debris and can cause nutrient deficiency and other problems. The ideal soil pH for most trees is 5 to 6.5 ([Day and Dickinson, 2008](#)).

Once the basic site assessment and soil analysis is compiled (see [3.D.2 LID Site Planning](#)), the following guidelines can be applied for site layout to incorporate trees ([Urban, 2008](#)):

- Plant in appropriate areas characterized by quality soils and adequate soil volume for the appropriate tree species.
- When designing spaces for trees, it is important to reduce impervious surfaces around or near the tree planting areas. Planting beds should be of an adequate size for the tree selected and special attention should be given to increasing soil and rooting volume. Tree planting areas should ideally be  $\geq 8$  feet wide.
- Do not pave near a mature tree's trunk flare. The trunk flare is the transition area between the base of the trunk and root crown and is often 2 to 3 times the trunk diameter (trunk diameter measured at 4 feet aboveground).
- Use permeable pavement for hard surfaces near trees to allow gas exchange and to promote soil moisture.
- Protect the tree and tree pit soil from surrounding uses (e.g., pedestrians, vehicles, ongoing maintenance activities).
- Avoid planting trees in areas where heavy snow storage occurs.
- Select trees that minimize conflicts with existing or planned utilities.

### **Planting Size**

A tree with a caliper measurement of 3 to 4 inches is the optimum planting size for deciduous trees in the urban setting ([Urban, 2008](#)). For coniferous trees, a planting height of 6 to 8 feet translates to a trunk with a caliper measurement of 3 to 4 inches. Plant availability for trees of a larger size can be a challenge. When a large quantity of trees of the same species is specified, it is important to select a size that can be readily provided by suppliers.

The time to recover from transplant shock is approximately 6 to 12 months per caliper inch depending on latitude ([Urban, 2008](#)). Planting larger trees is appealing to provide a more mature appearance initially; however, transplant shock may last longer and maintenance during recovery may be more extensive. In contrast, 3- to 4-inch-caliper trees will likely recover faster, with growth eventually surpassing that of the larger tree with less initial care ([Urban, 2008](#)).

## **Spacing**

Appropriate spacing of trees is dependent on the species selected and the planting environment. For example, a London plane tree (*Platanus acerifolia*) should be planted no closer than 40 feet on center and preferably 50 feet on center because of its large mature size. Smaller flowering trees can be placed much closer, perhaps 25 to 30 feet on center. In some settings, designers and arborists chose a closer tree spacing to achieve a more mature initial planting design effect, with the intent of removing trees at a future date as they reach more mature sizes. Tree spacing should be carefully considered based on local conditions and with the consultation of a landscape architect or arborist.

For parking lot tree planting, landscape codes often specify minimum tree spacing requirements. Some codes provide a performance standard approach to both tree spacing and size of required tree by requiring a certain percentage of paved area be covered in shade within a specified time frame (e.g., 50% of the paved area shaded within 5 years).

Generally, trees should be planted to allow mature tree crown development. Ideally, tree planting beds should be 8 feet wide. Where significant snow storage is anticipated, trees should be protected and planted away from significant snow accumulations. Plowed snow is denser and can be heavily laden with deicing chemicals and salts—either of which can be detrimental to healthy plant and tree growth.

Trees should be setback an adequate distance from plow lanes (6 feet minimum) in order to be protected from plow blade damage. In parking areas where snow accumulation can be significant, parking and drive lanes should be arranged to allow ease of snow plowing and to facilitate the protection of planting areas. Larger planting islands for trees should be located and aligned at the ends of parking rows. Intermediate tree planting islands can be provided at regular intervals in larger parking lots to visually break-up expansive asphalt areas.

## **Drainage**

Assessment of subgrade soils, ground water levels, and site drainage patterns should be used to determine soil water and optimum tree planting conditions. In general, the tree planting pit or reservoir in the tree rooting zone (18 to 24 inches) and above the underdrain (if installed) should drain down within 48 hours to encourage aerobic conditions and good root distribution through planting pit for many tree species ([Bartens et al., 2009](#)).

However, there are species more tolerant of prolonged saturated conditions. If the site assessment determines there is potential for extended ponding or dense, compacted soils are present, consult a qualified professional for appropriate drainage strategies and a landscape architect or arborist for appropriate tree species.

With adequate subgrade infiltration rates, tree planting areas can provide on-site retention of stormwater runoff. Careful assessment of subgrade soils, ground water levels, and site drainage patterns should be performed to determine soil water and optimum tree planting conditions ([Urban, 2008](#)).

Increasing the volume of soil and preventing compaction of existing soil in the tree planting areas for roots also increases the volume for stormwater storage and treatment. See the section below on soil depth and volume.

## **Soil Depth and Volume**

[\(Urban, 2008\)](#) recommends a minimum depth for planting soil of 30 to 48 inches. This depth should extend for a 10-foot radius around the tree in lawn areas.

Recommendations for adequate soil volume vary significantly for trees planted in conventional soil. [\(Lindsay and Bussuk, 1992\)](#) recommend approximately 8 cubic feet (cf) per 10 square feet (sf) of crown projection for a typical silt loam soil to provide the volume necessary to support adequate root structure. [\(Urban, 2008\)](#) recommends determining required soil volume depending on soil type, water availability and tree size (crown projection or trunk diameter), at a rate of 1 to 3 cf of soil per 1 sf of tree crown area. Where irrigation is provided, 1 cf of soil for every 1 sf of crown area is recommended. For trees without irrigation, soil volume should be increased to 3 cf for every 1 sf of crown area.

Strategies for increasing the soil depth and volume to promote healthy trees include the following:

- Use of soil amendment for trees
- Increasing soil and rooting volume
  - Soil cell systems
  - Structural soils
  - Creating root paths
  - Connecting to adjacent soil volume

## **Soil Amendment for Trees**

If possible, stockpile and reuse existing soils for tree planting. Relatively fine-grained soils can be reused and support healthy tree growth. For adequate drainage and tree health, [\(Urban, 2008\)](#) recommends avoiding topsoil that has more than 35% clay, 45% silt, or 25% fine sand. Loam, sandy loam, and sandy clay loam provide good textural classifications for supporting healthy tree growth [\(Urban, 2008\)](#).

If stormwater is directed to the tree planting area, a designed soil mix may be necessary to achieve adequate infiltration and drain-down characteristics. The water holding, organic matter, and chemical characteristics of the soil must be compatible with the water needs and other cultural requirements of the tree.

A variety of materials are available to amend existing soils or design a specific soil mix. Mineral soil amendments alter soil texture and improve infiltration and water holding characteristics. Common materials used in tree planters and planting areas include sand, expanded shale, clay and slate, and diatomaceous earth (see [\(Urban, 2008\)](#) for detailed descriptions for using mineral amendments).

Native soils across eastern Washington are relatively low in organic matter. Biologic and organic amendments should be used to improve organic matter content, infiltration capability, nutrient availability, soil biota, and cation exchange capacity, as appropriate. Biologic amendments include mycorrhizal fungi spores, kelp extracts, humic acids, organic fertilizers, and compost tea. If tree planting soil is poor quality, biologic amendments generally only offer a temporary improvement for tree growth.

## Soil Cell Systems

Soil cell systems are modular frames (base and pillar) with a deck that supports the pavement above and creates large spaces for uncompacted soil and tree roots. DeepRoot Green Infrastructure developed the Silva Cell, which is a common type of rigid load-bearing soil cell for trees. The decks are often designed for AASHTO H-20 loading (see [Figure 6.35: Silva Cell Filled With Bioretention Soil Mix and Topped With Permeable Pavers](#)). Many utilities can be installed within and through the cells; however, utilities require planning and careful consideration. Many types of soil can be used to fill the cells for a rooting medium, including imported soils designed for the specific tree or excavated soils (including heavier dense soils with higher clay content) amended with compost if necessary (ASLA, 2010). An advantage with soil cells is that > 90% of the volume created by the cell is available for soil.

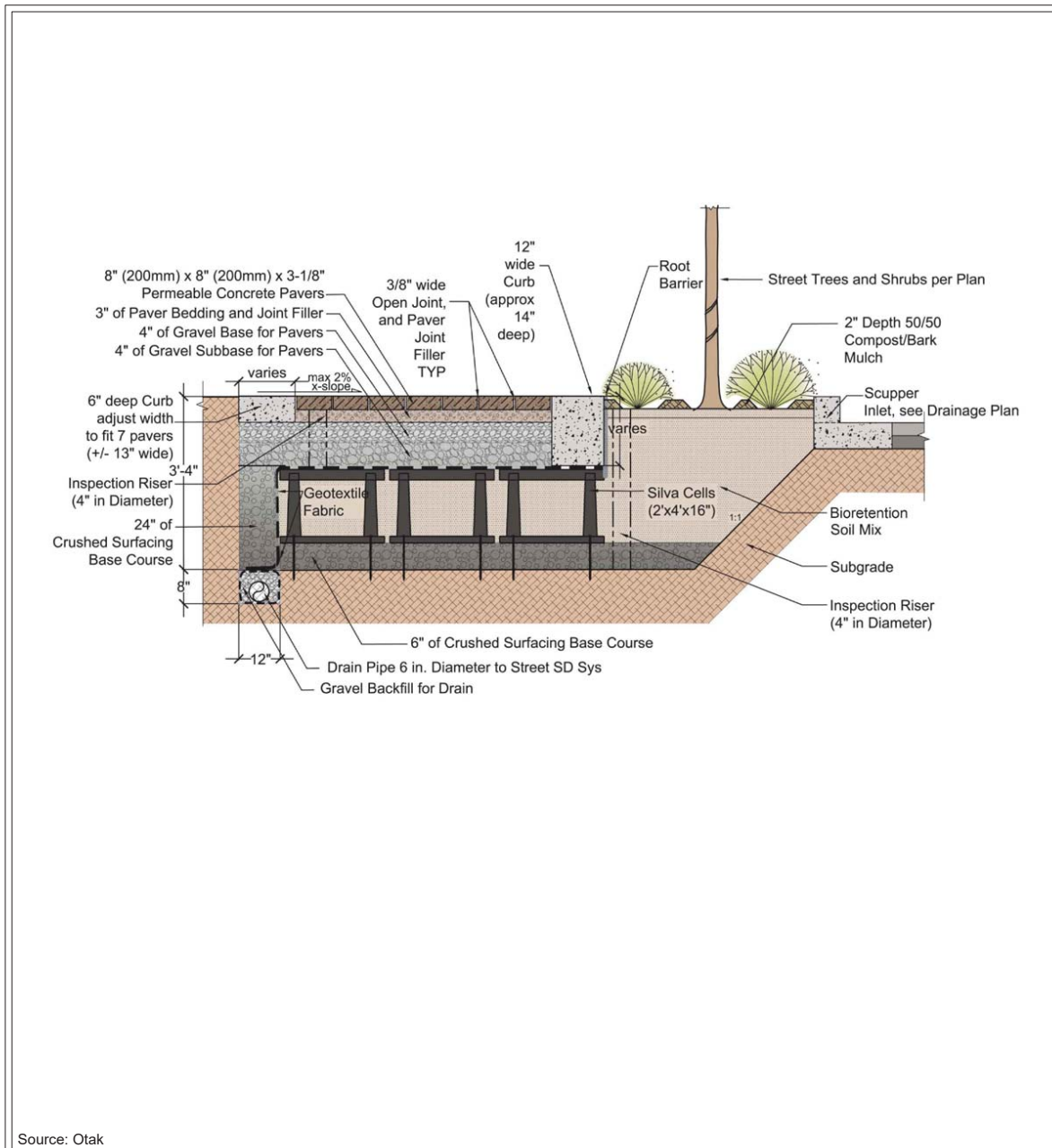
When soil cells are filled with a soil mix that meets Ecology's treatment requirements, such as bioretention soil media (see [6.3.5 Arid and Semiarid Climate Considerations](#), [BMP F6.23: Bioretention](#)), the system may be designed to be functionally equivalent to a bioretention BMP. See Ecology's Emerging Stormwater Treatment Technologies (TAPE) web page:

<https://ecology.wa.gov/Regulations-Permits/Guidance-technical-assistance/Stormwater-permittee-guidance-resources/Emerging-stormwater-treatment-technologies>

Soil cells designed to be equivalent to bioretention can greatly increase the return on investment for large trees by reducing or eliminating the need for downstream BMPs to meet [2.7.6 Core Element #5: Runoff Treatment](#) and [2.7.7 Core Element #6: Flow Control](#).



**Figure 6.35: Silva Cell Filled With Bioretention Soil Mix and Topped With Permeable Pavers**



Source: Otak



## Silva Cell Filled With Bioretention Soil Mix and Topped With Permeable Pavers

Revised June 2013

Please see <http://www.ecy.wa.gov/copyright.html> for copyright notice including permissions, limitation of liability, and disclaimer.

## Structural Soils

Structural soils provide a porous growth medium and structural support for sidewalks and street edges. Cornell University (CU Structural Soil™) developed one of the first structural soils in the early 1990s and others have since developed load-bearing growth media (e.g., Stalite). Structural soils are a mix of mineral soil (typically a loam or clay loam with ≥ 20% clay for adequate water and nutrient holding capacity) and coarse aggregate (typically uniformly graded ¾-inch to 1½-inch angular crushed rock) that, after compaction, maintains porosity (typically 25% to 30%) and infiltration capacity (typically > 20 inches per hour [in/hr]). Current research and installation experience has resulted in guidelines for designing with structural soil including the following:

- Structural soil can be used under all or part of the paved surfaces adjacent to trees to provide the necessary soil volume. Where structural soil is placed adjacent to open graded base aggregate, geotextile should be used to prevent migration of the fine aggregate in the structural soil to the more open graded material ([Bassuk et al., 2005](#)).
- **Soil depth:** 24 inches (minimum) to 36 inches (recommended) ([Bassuk et al., 2005](#)).
- **Compaction:** 95% Proctor ([Bassuk et al., 2005](#)).
- **Tree pit opening:** If the tree pit opening is at least 5 feet x 5 feet, a well-drained top soil can be used in the planting area. If the opening is smaller, structural soil can be used immediately under and up to the root ball ([Bassuk et al., 2005](#)).
- **Available soil:** The structural aggregate uses approximately 80% of the available space; therefore, approximately 20% of the total planting volume is available soil to support tree growth.
- **Soil volume:** 2 cf for each 1 sf of crown projection (mature tree) is a well-accepted industry standard. Because the structural aggregate uses approximately 80% of the available space, 10 cf of structural soil for each 1 sf of crown projection (mature tree) may be needed.
- **Planters with impervious walls:** Openings filled with uncompacted soil can be used to allow roots to access surrounding structural soil ([Bassuk et al., 2005](#)).
- **Tree species:** Use species that are tolerant of well-drained soil and periodic flooding.
- **Drain-down:** Structural soil reservoir should drain down within 48 hours to encourage good root distribution through planting pit ([Bartens et al., 2009](#)).

Many structural soils are proprietary mixes distributed through licensed providers. Sand-based structural soil (SBSS) is an urban tree planting system that is not proprietary. SBSS consists of a uniform gradation of medium to coarse sand (typically 30 inches deep) mixed with compost (2% to 3% by volume) and loam to achieve approximately 8% to 10% silt by volume.

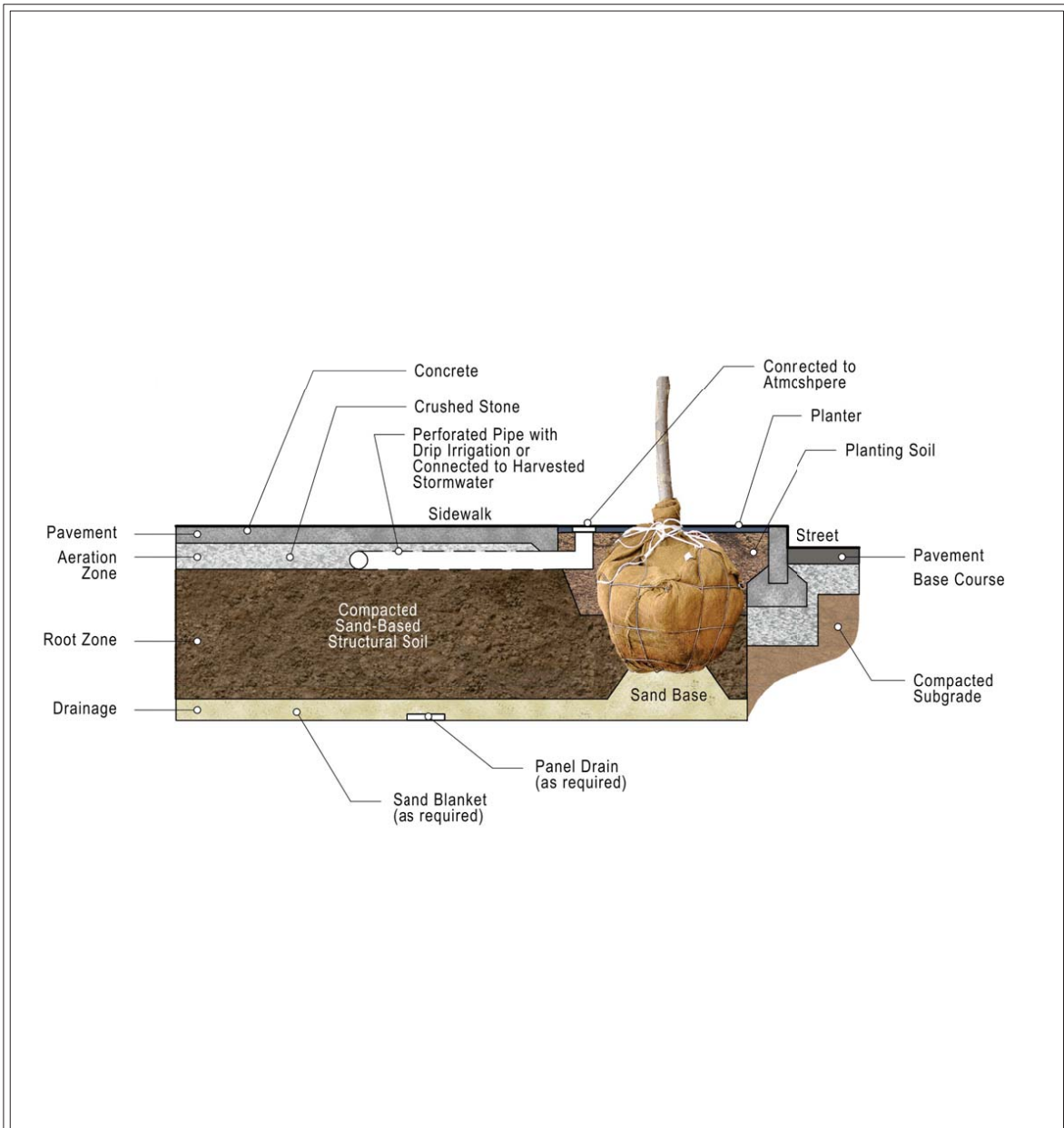
In general, the saturated hydraulic conductivity should be approximately 4 to 6 in/hr. The uniformly graded sand maintains porosity and infiltration capacity when compacted; however, the load-bearing capacity of the mix is reduced due to the uniform particle size. Accordingly, crushed rock is used between the sand and surface wearing course (see [Figure 6.36: Sand-Based Structural Soil Section](#)).

If using structural soil to meet stormwater treatment requirements, the designer will need to demonstrate that the soil mix meets Site Suitability Criterion 4 (SSC-4), Soil Infiltration Rate/Drawdown Time, and SSC-6, Soil Physical and Chemical Suitability for Treatment (see [5.4.3 General Criteria for Infiltration and Bioinfiltration BMPs](#)).

A subsurface irrigation port that can be accessed from the surface of the tree pit or drip irrigation should be incorporated for initial establishment of trees and subsequent irrigation if necessary ([ASLA, 2010](#)). As with all urban tree systems, excess water and anaerobic soil conditions can impair or kill trees and subsurface drainage layers or underdrains should be considered to manage soil moisture on subgrades with low permeability. Structural soils can be used in conjunction with permeable pavement ([Haffner et al., 2007](#)).

Contact authorized distributors and see ([Day and Dickinson, 2008](#)) for guidelines on specific structural soil products.

**Figure 6.36: Sand-Based Structural Soil Section**



Source: AHBL, Inc.



## Sand-Based Structural Soil Section

Revised June 2013

Please see <http://www.ecy.wa.gov/copyright.html> for copyright notice including permissions, limitation of liability, and disclaimer.

## Creating Root Paths

Root paths are a technique to connect planting areas, interconnect tree roots, or guide roots out of confined areas to soil under pavement or adjacent to paved area that has the capability to support root growth (e.g., uncompacted, adequately drained loams). The actual root paths add only small amounts of rooting volume. The path trenches are typically 4 inches wide by 12 inches deep and filled with a strip drain board and topsoil. Root paths are excavated with a standard trenching machine, placed approximately 4 feet on center, and compacted with a vibrating plate compactor to retain subgrade structural integrity for pavement. The trenches should be extended into the tree planting pit a minimum of 1 foot and preferably within a few inches of the tree root ball ([Urban, 2008](#)).

## Connecting to Adjacent Soil Volume

Soil trenches are used to increase soil and root volume, connect to other tree planting areas, and importantly, connect to larger areas with soil that have the capability to support root growth (e.g., uncompacted, adequately drained loams). The trenches are typically 5 feet wide with sloped sides for structural integrity and filled with topsoil or a designed soil mix. The installed soil is lightly compacted (e.g., 80% Proctor) with a gravel base placed on top of the soil to increase support for the sidewalk. The sidewalk is reinforced with rebar and thickened to span the soil trench. The thickened portion should extend a minimum 18 inches onto the adjacent compacted subgrade. An underdrain may be necessary depending on subgrade soil with low infiltration rates and if stormwater is directed to the tree planting area (see the above section, Drainage, and consult with a licensed professional for drainage requirements). Provide subsurface irrigation conduit preferably from stormwater or harvested water in areas with < 30 inches of annual precipitation ([Urban, 2008](#)).

## Retention and Protection

Trees shall be retained, maintained, and protected on the site after construction and for the life of the development or until any approved redevelopment occurs in the future. Trees that are removed or die shall be replaced with like species during the next planting season. Trees shall be pruned according to industry standards (ANSI A 300 standards).

## Design Procedure

### Retained Trees

Runoff modeling adjustments for retained trees can be applied to reduce impervious surface areas that are entered into hydrologic models used to size flow control BMPs (see [Chapter 4 - Hydrologic Analysis and Design](#)). Adjustments are provided as a percentage of the existing tree canopy area. The minimum tree canopy necessary for an existing tree is identified in [Table 6.12: Runoff Modeling Adjustments for Retained Trees](#).

**Table 6.12: Runoff Modeling Adjustments for Retained Trees**

Tree Type	Modeling Adjustment
Evergreen	20% of canopy area (minimum of 100 sf/tree)
Deciduous	10% of canopy area (minimum of 50 sf/tree)
Impervious Area Mitigated = $\sum \text{Canopy Area} * \text{Credit \%} / 100$ .	

Runoff modeling adjustments are not applicable to trees in native vegetation areas used for flow dispersion. Runoff modeling adjustments are also not applicable to trees in planter boxes. The total runoff modeling adjustment for retained trees may not exceed 25% of impervious or other hard surface requiring mitigation.

### **Newly Planted Trees**

Runoff modeling adjustments for newly planted trees are provided in [Table 6.13: Modeling Adjustments for Newly Planted Trees](#) by tree type. Where locally allowed, runoff modeling adjustments for new trees may be applied to reduce the impervious surface areas that are entered into hydrologic models used to size flow control BMPs (see [Chapter 4 - Hydrologic Analysis and Design](#)).

**Table 6.13: Modeling Adjustments for Newly Planted Trees**

<b>Tree Type</b>	<b>Modeling Adjustment</b>
Evergreen	50 sf/tree
Deciduous	20 sf/tree

Runoff modeling adjustments are not applicable to trees in native vegetation areas used for flow dispersion. Runoff modeling adjustments are also not applicable to trees in planter boxes. The total runoff modeling adjustment for newly planted trees should not exceed 25% of impervious or other hard surface requiring mitigation.

### ***Construction Criteria***

Protecting new and existing trees and minimizing soil compaction during construction is essential to maintain infiltration and adequate growing characteristics in the built environment. This is particularly true in urban areas. The designer should pay close attention to construction sequencing and material staging from the planning through construction phases as well as tree protection measures after the project is completed. It is also important to protect construction site soils from compaction and contamination in tree planting areas.

**For more information:** See the construction criteria in [BMP F6.61: Amending Construction Site Soils](#) for guidelines.

### ***Operation and Maintenance Criteria***

There are a vast number of resources associated with proper tree maintenance practices. Washington State University Extension staff in Spokane, Wenatchee, and other areas of eastern Washington have prepared guidance for general tree maintenance that can be found on Washington State University's website:

<http://www.wsu.edu/>

Additional sources of species-specific maintenance guidance can be found in The New Sunset Western Garden Book ([Sunset Magazine, 2012](#)).

## **BMP F6.63: Vegetated Roofs**

Vegetated roofs (also known as ecoroofs and green roofs) are thin layers of engineered soil and vegetation constructed on top of conventional flat or sloped roofs ([WSU - PSP, 2012](#)). Vegetated roofs provide wide-ranging benefits, such as reducing the effective impervious area, promoting on-site retention and evapotranspiration of stormwater runoff, and potentially reducing the size of downstream flow control BMPs needed. Air quality and habitat are also enhanced through the use of vegetated roofs.

Perhaps the two most compelling benefits of vegetated roofs that are unassociated with stormwater are those associated with energy savings and service life. The planting system of a vegetated roof creates a buffer between ambient air temperature and the roof insulation. The result is a minimization in fluctuation between high and low temperatures. These benefits can reduce the load on the building's mechanical heating and cooling systems resulting in considerable energy savings.

Properly constructed vegetated roofs also last longer than most conventional roofing membranes. Vegetated roofs last longer because the waterproof membrane is protected from ultraviolet rays. The vegetation and substrate cover the membrane and protect it from thermal shock stresses that can result in excessive wear and cracking.

Vegetated roofs have become increasingly popular on office, industrial, and warehouse structures where large, flat roofs are typical of design. The use of vegetated roofs on residential structures in the United States is less common. Many single-family residential roof structures were never designed to accommodate the wet soil loads associated with a vegetated roof. Consequently, the retrofit of residential structures for a vegetated roof often requires significant structural buttressing. Residential structures may also have steeply pitched roofs that make vegetated roofs either technically or economically infeasible.

The following subsections provide design guidance on extensive and intensive vegetated roofs.

### **Extensive Applications**

Extensive vegetated roofs have a shallow (< 6 inches depth) growing medium. These roof designs are typically light-weight structures (approximately 10 to 35 pounds per square foot when wet) that cover large expanses of rooftop and require minimal maintenance. Extensive vegetated roofs do not typically accommodate human use, except for maintenance access ([Dunnett and Kingsbury, 2008](#)). Their intent is to maximize the total vegetated area. These are particularly good for roof retrofits, in which the structural capacity of the roof cannot necessarily be improved.

### **Intensive Applications**

Intensive vegetated roofs typically accommodate human recreational use in that they are used much like a typical garden ([Dunnett and Kingsbury, 2008](#)). Intensive vegetated roofs use a deeper growing medium (> 6 inches) and can include small trees and shrubs. They tend to be more expensive and their heavier weight on the roof (approximately 50 to 300 pounds per square foot when wet) must be considered during the design of the roof structure ([University of Florida, 2008](#)). They are often built in highly visible areas, such as outdoor roof terraces. Intensive designs are more likely to succeed in

new construction where the load bearing capacity of the roof is designed concurrently with the vegetated roof.

The classification of extensive versus intensive roofs is used here to present the well-accepted vernacular of vegetated roof design. These typologies have been helpful in the past at indicating the kinds of plants and functions the vegetated roof could provide. The fact is, if done correctly, elements of one can be incorporated in the other.

## **Screening Criteria**

Designers should be prepared to evaluate vegetated roofs for both technical and economic feasibility. For new construction, technical feasibility will involve ensuring that the roof is designed to handle the wet soil and snow loads customary to the microclimate of the site. A vegetated roof is considered infeasible if it cannot accommodate the following wet loads:

- 10 to 35 pounds per square foot (lb/sf) for extensive designs
- 50 to 300 lb/sf for intensive designs

For retrofit applications, the wet-load structural requirements may make vegetated roofs economically infeasible.

The pitch of an existing roof may also make the use of a vegetated roof infeasible. Vegetated roofs should be avoided on roofs with a pitch > 20 degrees unless stabilization measures are in place ([WSU - PSP, 2012](#)).

The economic feasibility of a vegetated roof should be reviewed in the larger context of the cost to operate and maintain the building. The vegetated roof will contribute stormwater values that should be considered when feasibility analyses are performed. Other inputs to the economic feasibility analysis for a vegetated roof should include its longer service life over most conventional roofing materials and the savings in heating and cooling costs.

## **General Criteria**

Vegetated roofs can be an effective low impact development (LID) BMP in eastern Washington. However, freezing temperatures, heavy snowfall, strong winds, and hot, arid summers need to be considered when analyzing the use of a vegetated roof.

While vegetated roofs can be installed on slopes up to 40 degrees, slopes between 5 and 20 degrees are most suitable and can provide natural drainage by gravity. Roofs with slopes > 10 degrees require an analysis of engineered slope stability and those > 20 degrees require a structural reinforcement system and additional assemblies to hold the soil substrate and drainage aggregate in place ([WSU - PSP, 2012](#)).

During the initial planning stages, the designer should consider the following questions:

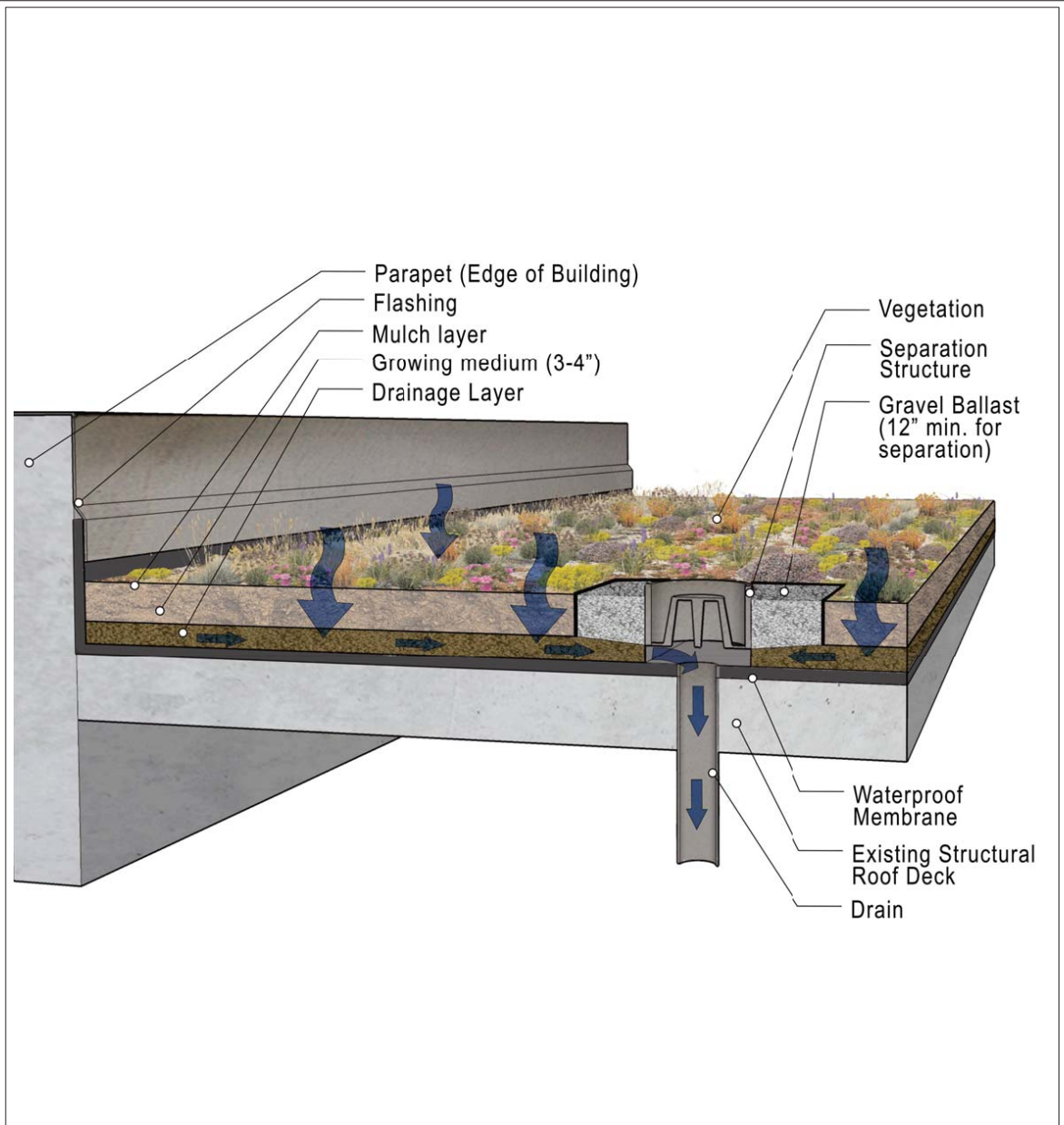
- What is the appropriate type and design of vegetated roof based on its intended function?
- Is the load bearing capacity of the building able to support the intended vegetated roof? What is that capacity? Is the size of the roof sufficient?



- Can the vegetated roof be maintained easily and affordably?
- What stormwater benefits will accrue from the design?

General design criteria for the major components of vegetated roofs, including the roof deck, roof structural support, fire protection, protective layer, waterproof layer, drainage layer, substrate, vegetation, and leak detection systems (optional), are provided below. See [Figure 6.37: Basic Vegetated Roof Components](#) for an illustration of each component of a vegetated roof.

**Figure 6.37: Basic Vegetated Roof Components**



Source: Low Impact Development Approaches Handbook (CleanWater Services, 2009)



## Basic Vegetated Roof Components

Revised June 2013

Please see <http://www.ecy.wa.gov/copyright.html> for copyright notice including permissions, limitation of liability, and disclaimer.

## **Roof Deck**

The roof deck can be made of steel, concrete, plywood, or any other material sufficiently strong to support the load of the vegetated roof. The slope of the roof deck beneath the vegetated roof should be slightly steeper than conventional roofs because minor ponding will not evaporate as quickly under a vegetated roof assembly.

As discussed above in this section, vegetated roof slopes between 5 and 20 degrees are most suitable and can provide natural drainage by gravity. Roofs with slopes > 10 degrees require an analysis of engineered slope stability and those > 20 degrees require a structural reinforcement system and additional assemblies to hold the soil substrate and drainage aggregate in place ([WSU - PSP, 2012](#)).

## **Roof Structural Support**

Ensure that the additional weight of the vegetated roof is distributed evenly across the roof deck and support structure below. Working closely with a licensed engineer in the state of Washington with structural expertise throughout the design of the vegetated roof is essential. Consider the weight of saturated soils, weight of snow in the winter, as well as a maintenance regime to mechanically remove snow buildup to prevent roof damage and collapse.

## **Fire Protection**

Flammable materials in the construction of the vegetated roof should be avoided because of the dry heat that is known to occur in eastern Washington. Designers should maintain a clear rock or gravel border around parapet walls, rooftop windows, chimneys, and other openings where fire may spread. Specifying fire-resistant vegetation can also minimize the total amount available fire fuel. Factory Mutual's knowledge center at the following web address provides fire ratings, research, and testing related to reducing property-related hazards:

<http://www.fmglobal.com/>

## **Protective Layer – Root Penetration Layer**

Maintaining a continuous separation between the roof membrane and vegetative root zone will reduce the potential for root damage. The material should be raised above the substrate at the edges and around vertical projections, like vents.

## **Waterproof Layer**

Various mechanically produced materials are available for waterproofing the roof, such as rolled sheets or inorganic single-ply membrane or fluid-applied membranes. Ensuring a complete seal on these membranes, especially at the joints, is critical. Oil-based bitumen and asphalt felt and fabrics are the most common form of roofing materials; however, they contain more organic material and decompose, requiring more frequent maintenance, leaving roofs susceptible to leaks.

## **Drainage Layer**

Drainage layers store and channelize stormwater infiltrated through the substrate and offer additional space for plant roots. Materials used may be granular rock, porous mats, lightweight plastic or polystyrene drainage modules. Selection of materials will depend on weight requirements as well as the objectives of stormwater system design.

Vegetated roofs provide their greatest contribution to stormwater management for low- to moderate-intensity storms. Heavy storms saturate the soil more quickly, thereby reducing retention potential on a shorter timeline. The drainage layer should seek to balance the objectives of storage and drainage.

### **Substrate**

Vegetated roof soil, or substrate, must support the chemical, biological, and physical requirements of the plants, which is especially challenging due to the system's disconnection from the ground. Substrate varies in depth and composition for structural, planting, and stormwater management purposes. Depending on the soil composition and weight, additional roof support may be required. Weight, water storage, and nutrient-holding capacity are the primary factors to be considered when selecting substrate and drainage material ([WSU - PSP, 2012](#)).

The substrates of vegetated roofs perform the majority of water retention. The amount of water retained is primarily a factor of substrate depth, although studies suggest that substrates deeper than 6 inches do not necessarily provide more retention capability ([Retzlaff, 2006](#)).

Substrate depths of 2 to 3 inches support a wider range of succulent species, grasses, and herbaceous plants. Depths of 4 to 8 inches will enable a wide range of drought-tolerant perennials and grasses and some tough small shrubs. Substrate depths of 12 to 20 inches will allow the growth of many perennials and shrubs, whereas trees require 32 to 52 inches.

### **Vegetation**

The main difference between a plant palette in an on-the-ground landscape amenity and one on a vegetated roof is root depth. Vegetated roofs need shallow rooted species that are adapted to thin soil profiles, high temperatures, and periods of drought. Additionally, diverse palettes, as opposed to monocultures, tend to result in better overall plant survival. Select plants that:

- Cover and anchor the substrate surface relatively quickly;
- Form a self-repairing mat;
- Take up and transpire the available/retained water; and
- Survive the extreme climate conditions (cold hardy, drought-tolerant, wind-tolerant).

Eastern Washington has many good native and highly adapted plant choices that are appropriate to vegetated roof settings. These plant choices are tolerant of the extreme climate conditions that exist. For extensive roof designs, designers should consider selecting naturally occurring plant species that survive with little to no input. Meadow-like bunchgrass mixes and desert shrub-steppe plants may also be appropriate in some settings of eastern Washington.

### **Leak Detection Layer (Optional)**

Electronic leak detection systems are an optional technology designed to precisely locate a leak if one occurs after construction. Using a leak detection system reduces the likelihood that the significant portions of the vegetated roof materials will have to be removed in the event of a leak ([WSU - PSP, 2012](#)).

## ***Design Procedure***

Vegetated roofs should be designed on a site-by-site, building-by-building basis so that all opportunities and constraints are comprehensively evaluated and used to guide the vegetated roof design.

Sizing requirements for vegetated roofs will vary considerably depending on the type of roof (e.g., extensive or intensive), structural loading requirements, roof size and drainage needs, etc. Consult a licensed engineer in the state of Washington with structural expertise for sizing the system for structural capacity, a licensed professional for sizing drainage system components, a landscape architect for determining plant type, sizes, and spacing, and other licensed professionals as needed based on the site-specific application.

A two-step procedure for sizing vegetated roofs for flow control is provided in the following text and [Table 6.14: Sizing Methods and Assumptions for Vegetated Roofs](#).

1. Determine the depth of the vegetated roof growing medium (D).
2. Select an appropriate land use type for input into the hydrologic model (see [Chapter 4 - Hydrologic Analysis and Design](#) for hydrologic modeling methods).
  - For vegetated roof surfaces with 3 to 8 inches of growing medium, model the roof surface as 50% lawns, heavy soil (open space, fair condition) area and 50% impervious area.
  - For vegetated roof surfaces with > 8 inches of growing medium, model the roof surface as 50% lawns, sandy soil (open space, good condition) and 50% impervious area.

**Table 6.14: Sizing Methods and Assumptions for Vegetated Roofs**

Step	Variable	Methods and Assumptions <sup>a</sup>
1	Depth of Growing Medium (D)	<ul style="list-style-type: none"> <li>• Succulent species, grasses, and herbaceous plants = 2 to 3 inches</li> <li>• Drought-tolerant perennials and grasses and some tough small shrubs = 4 to 8 inches</li> <li>• Perennials and shrubs = 12 to 20 inches</li> <li>• Trees = 32 to 52 inches</li> </ul>
2	Modeled Land Use	<ul style="list-style-type: none"> <li>• For 3 to 8 inches growing medium depth                             <ul style="list-style-type: none"> <li>◦ Model the roof surface as 50% lawns, heavy soil (open space, fair condition) area and 50% impervious area.</li> </ul> </li> <li>• For &gt; 8 inches growing medium depth                             <ul style="list-style-type: none"> <li>◦ Model the roof surface as 50% lawns, sandy soil (open space, good condition) and 50% impervious area</li> </ul> </li> </ul>
<sup>a</sup> See local jurisdiction requirements for locally required methods and assumptions where applicable.		

**For more information:** Consult local regulations to determine specific procedures to be used in modeling the hydrologic benefits of vegetated roofs and sizing downstream BMPs.

### Construction Criteria

Construction sequencing is critically important for vegetated roof construction, because numerous trades are involved, each with their particular roles and potential conflicts during construction. For example, construction may require coordination among a general contractor, landscape contractor, roofing contractor, leak detection specialist, irrigation specialist, HVAC contractor, and construction inspectors, all of whom require access to the roof areas at various times during construction. The waterproof membrane must be protected once installed and should be tested prior to placement of the growth medium and other subsequent vegetated roof materials ([WSU - PSP, 2012](#)). There are many ways of establishing plants in a vegetated roof. The most common methods of plant establishment include the following:

- Direct application of seed or cuttings
- Planting of pot-grown plants or plugs
- Laying of pregrown vegetation mats or grids

Making the roofing contractor responsible for the vegetated roof installation, either directly or by means of subcontracted services, can help ensure that the integrity of the waterproof membrane is maintained during construction.

Off-the-shelf vegetated roof products have become popular as roofing companies seek to fill the growing demand for vegetated roofs. Off-the-shelf products are typically installed by roofing contractors that are licensed by the company that furnished or grew the vegetation mats or trays. Where off-the-shelf roof systems are selected, the product design will be provided by the company that grew the vegetation mats or trays based on the microclimatic conditions provided by a licensed professional and the building design provided by the architect and licensed engineer in the state of Washington with structural expertise.

### **Operation and Maintenance Criteria**

The level of maintenance for vegetated roofs will vary depending on soil depth, vegetation type and diversity, and location. The following practices should be performed:

- All vegetated roof components, including structural components, waterproofing, drainage layers, soil substrate, vegetation, and drains, should be inspected throughout the life of the system, no less than two times per year for extensive installations and four times per year for intensive installations. Some manufacturers may suggest monthly inspections.
- For plant establishment, water efficient irrigation should be applied for at least the first 2 years and preferably for 3 years. Irrigation needs after establishment will depend on climate, plant health, and preferred maintenance practices.
- Avoid the use of pesticides, herbicides, and fertilizers.
- During the fall and spring rainy seasons, check drains monthly and remove any accumulated sediment or debris.
- Remove dead plants and replant as needed in spring and fall to maintain substantial plant coverage. At least 90% coverage is recommended.
- During the first growing season, remove weeds and undesirable plant growth monthly. In subsequent years, remove weeds and undesirable plant growth monthly in late spring and early fall, as needed.

**For more information:** See [Appendix 6-A: Recommended Maintenance Criteria for Flow Control BMPs](#) for additional maintenance recommendations for this BMP.

### **BMP F6.64: Minimal Excavation Foundations**

Grading and excavation during construction can degrade the infiltration and storage capacity of native soils. A minimal excavation foundation is a building best management practice (BMP) that minimizes mass grading and site disturbance by distributing a building's structural load onto piles or limited excavation perimeter walls.

As noted in the *Low Impact Development Technical Guidance Manual for Puget Sound* ([WSU - PSP, 2012](#)), “[m]inimal excavation foundation systems take many forms, but in essence are a combination of driven piles and a connecting component at, or above, grade. The piles allow the foundation system to reach or engage deeper load-bearing soils without having to dig out and disrupt upper soil layers, which convey, infiltrate, store, and filter stormwater flows.”

Piles are a less disruptive approach to site development. The piles may be vertical, screw-augured, or angled pairs that can be made of corrosion-protected steel, wood, or concrete. The connection component handles the transfer of loads from the above structure to the piles and is most often made of concrete. Cement connection components may be precast or poured on-site in continuous perimeter wall or isolated pier configurations.

Although not as widely used as other low impact development (LID) BMPs, minimal excavation foundations hold an important place within LID guidance. Minimal excavation foundations can make sites developable that would be otherwise undevelopable. Sites with shallow depth to bedrock, high water tables, or challenging soils such as the lithosols and caliche soils that occur in various areas of eastern Washington can be made buildable through the use of minimal excavation foundations.

### **Screening Criteria**

Consult with a licensed engineer in the state of Washington with geotechnical and structural expertise to determine the feasibility of using limited excavation foundations. Designers should consider the following guidance:

- Minimal excavation foundations generally are not suitable for structures greater than three stories high.
- Perimeter walls with pins generally should not be used on sites with slopes > 10%.
- Piers generally should not be used on sites with slopes > 30%
- Minimal excavation foundations should not be used on sites with high organic content or low bearing capacity unless the depth to bearing soils is limited (use is subject to review and evaluation by a licensed engineer in the state of Washington with geotechnical expertise).
- Minimal excavation foundations should not be used on fill soils unless the pilings can reach the bearing soils (use is subject to review and evaluation by a licensed engineer in the state of Washington with geotechnical expertise).

### **General Criteria**

Minimal excavation foundations in both pier and perimeter wall configurations are suitable for residential or commercial structures up to three stories high. Accessory structures such as decks, porches, and walkways can also be supported, and the technology is particularly useful for elevated paths and foot-bridges in open spaces and other environmentally sensitive areas. Wall configurations are typically used on flat to sloping sites up to 10%, and pier configurations flat to 30%.

The minimal excavation foundation approach can be installed on all soils, provided the material is penetrable and will support the intended type of piles. Soils typically considered problematic due to high organic content (e.g., topsoils or peats) or overall bearing characteristics may often remain in place provided their depth is limited and the pins have adequate penetration into suitable underlying soils.

These systems may be used on fill soils if the depth of the fill does not exceed the reaction range of the intended piles. Fill compaction requirements for support of such foundations may be below those of conventional development practice in some applications. In all cases, for both custom and



preengineered systems, a qualified professional should determine the appropriate pile and connection components and define criteria for specific soil conditions and construction requirements.

Based on the type of structure to be supported and the specific site or lot topography, a pier-type foundation or perimeter-wall-type foundation must first be selected (see [Figure 6.38: Pier-Type Minimal Excavation Foundation](#) and [Figure 6.39: Wall-Type Minimal Excavation Foundation](#)). Soil conditions are determined by a limited geotechnical analysis identifying soil type, water content at saturation, strength and density characteristics, and in-place weight. However, depending on the pile system type, the size or scale of the supported structure, and the nature of the site and soils, a more complete soils report including slope stability and liquefaction analysis may be required.

Piers using pin piles can be used for various structure types, including residential and light commercial buildings. When designing with piers, the licensed professional or vendor supplies the structural requirements (pile length and diameter and pier size) for the pier system. A licensed engineer in the state of Washington with structural expertise then determines the number and location of piers given the structure size, loads, and load bearing location.

Roof runoff and surrounding storm flows may be allowed to infiltrate without using constructed conveyance when selection of the foundation type and grading strategy results in retention of the top layers of soil without significant reduction in soil permeability and storage capability.

Where possible, roof runoff should be infiltrated uphill of the structure and across the broadest possible area. Infiltrating upslope more closely mimics natural (preconstruction) conditions by directing subsurface flows through minimally impacted soils surrounding, and in some cases, under the structure. This provides infiltration and subsurface storage area that would otherwise be lost in the construction and placement of a conventional “dug-in” foundation system. Passive gravity systems for dispersing roof runoff are preferred; however, active systems can be used if backup power sources are incorporated and a consistent and manageable maintenance program is ensured.

Garage slabs, monolithic-poured patios, or driveways can block dispersed flows from the minimal excavation foundation perimeter and dispersing roof runoff uphill of these areas is not recommended (or must be handled with other stormwater management practices). Some soils and site conditions may not warrant intentionally directing subsurface flows directly beneath the structure, and in these cases, only the preserved soils surrounding the structure and across the site may be relied on to mimic natural flow pathways.

**Figure 6.38: Pier-Type Minimal Excavation Foundation**



Source: AHBL, Inc.



DEPARTMENT OF  
**ECOLOGY**  
State of Washington

## Pier-Type Minimal Excavation Foundation

Revised June 2013

Please see <http://www.ecy.wa.gov/copyright.html> for copyright notice including permissions, limitation of liability, and disclaimer.

**Figure 6.39: Wall-Type Minimal Excavation Foundation**



Source: Pin Foundations, Inc.



## Wall-Type Minimal Excavation Foundation

Revised June 2013

Please see <http://www.ecy.wa.gov/copyright.html> for copyright notice including permissions, limitation of liability, and disclaimer.

## Design Procedure

1. Determine the size and quantity of pin piles based on the size of the structure, number of stories, and weights of materials used. Pin piles should be sized to resist both gravity (dead, live, and snow) and lateral loads (wind and seismic). Additional design considerations include uplift resistance for seismic overturning forces. Sizing of minimal excavation foundations is performed by a licensed engineer in the state of Washington with structural and geotechnical expertise on a site-by-site basis.
2. Incorporate the flow control benefits of minimal excavation foundation BMPs in the hydrologic model for the project site. Where residential roof runoff is dispersed on the upgradient side of a structure in accordance with [BMP F6.41: Sheet Flow Dispersion](#), the tributary roof area may be entered into the hydrologic model for sizing flow control BMPs as pasture underlain by the native soil type.

**For more information:** See [Chapter 4 - Hydrologic Analysis and Design](#) for hydrologic modeling methods.

## Construction Criteria

### Piers

Pier applications require grubbing, and in some cases, blading to prepare the site. The permeability of some soil types can be significantly reduced even with minimal equipment activity; accordingly, the lightest possible tracked equipment should be used for preparing or grading the site. Consult a qualified professional with soils experience for site specific recommendations.

On relatively flat sites, blading should be limited to shaping the site for the best possible drainage and infiltration. Removing the organic topsoil layer is not typically necessary. On sloped sites, the soils may be bladed smooth at their existing grade to receive pier systems, again with the goal of achieving the best possible drainage and infiltration. This will result in the least disturbance to the upper permeable soil layers on sloped sites.

Minimal excavation systems may be installed “pile first” or “post pile.” The pile first approach involves driving or installing all required piles in specified locations to support the structure, and then installing a connecting component (such as a formed and poured concrete grade beam) to engage the piles. Post pile methods require the setting of precast or site poured components first, through which the piles are then driven. Pile first methods are typically used for deep or problematic soils where final pile depth and embedded obstructions are unpredictable. Post pile methods are typically shallower using shorter, smaller diameter piles—and used where the soils and bearing capacities are well defined. In either case, the piles are placed at specified intervals correlated with their capacity in the soil, the size and location of the loads to be supported, and the carrying capacity of the connection component.

The piles are driven with a machine mounted, frame mounted, or handheld automatic hammer. The choice of driving equipment should be considered based on the size of pile and intended driving depth, the potential for equipment site impacts, and the limits of movement around the structure.

### Walls

Piling combined with precast walls with sloped bases, or slope cut forms for pouring continuous walls, may be used on sites with limited topography changes similar to the pier applications. Rectilinear wall systems (flat bottom sections), combined with piles, may also be used, but require more site preparation and soil disturbance.

While creating more soil disturbance, sloped sites should be terraced to receive conventional flat-bottomed forms or precast walls. The height difference between terraces will be a result of the slope percentage and the width of the terrace itself. The least impacts on soil will be achieved by limiting the width of each terrace to the width of the equipment blade and cutting as many terraces as possible. Some footprint designs will be more conducive to limiting these cuts and should be considered by the designer.

The terracing technique removes more of the upper permeable soil layer and this loss should be figured into any analysis of storm flows through the site. As with the pier systems, consult a qualified professional with soils experience for specific recommendations.

With wall systems, a free draining, compressible buffer material (pea gravel, corrugated vinyl or foam product) should be placed on surface soils to prepare the site for placement of wall components. This buffer material separates the base of the grade beam from surface of the soil to prevent impacts due to expansion or frost heave and, in some cases, is used to allow movement of saturated flows beneath the wall.

Additional soil may remain from foundation construction depending on grading strategy and site conditions. The material may be used to backfill the perimeter of the structure if the impacts of the additional material and equipment used to place the backfill are considered when evaluating runoff conditions.

### ***Operation and Maintenance Criteria***

Corrosion rates for buried galvanized or coated steel piling, or degradation rates for buried concrete piling, are typically very low to nonexistent, and piling for these types of foundations are usually considered to last the life of the structure. Special conditions such as exposure to salt air or highly caustic soils in unique built environments, such as industrial zones, should be considered. Wood piling typically has a more limited lifetime. Some foundation systems also allow for the removal and replacement of pilings, which can extend the life of the support indefinitely.

*This page has been intentionally left blank for double-sided printing.*

# Appendix 6-A: Recommended Maintenance Criteria for Flow Control BMPs

## 6.A.1 Introduction

The Best Management Practice (BMP)-specific maintenance criteria contained in this appendix are intended to be conditions for determining if maintenance actions are required as identified through inspection. They are not intended to be measures of the required condition of the BMP at all times between inspections. In other words, an exceedance of these conditions at any time between inspections and/or maintenance does not automatically constitute a violation of these criteria. However, based on inspection observations, the inspection and maintenance schedules shall be adjusted to minimize the length of time that a BMP is in a condition that requires a maintenance action.

### *Tables in this Appendix*

- [Table 6.15: Maintenance Criteria for Detention Ponds](#)
- [Table 6.16: Maintenance Criteria for Detention Vaults/Tanks](#)
- [Table 6.17: Maintenance Criteria for Control Structures](#)
- [Table 6.18: Maintenance Criteria for Catch Basins](#)
- [Table 6.19: Maintenance Criteria for Drywells](#)
- [Table 6.20: Maintenance Criteria for Infiltration Ponds](#)
- [Table 6.21: Maintenance Criteria for Evaporation Ponds](#)
- [Table 6.22: Maintenance Criteria for Rainwater Harvesting](#)
- [Table 6.23: Maintenance Criteria for Permeable Pavement](#)
- [Table 6.24: Maintenance Criteria for Amended Construction Site Soils](#)
- [Table 6.25: Maintenance Criteria for Vegetated Roofs](#)

*This page has been intentionally left blank for double-sided printing.*



## 6.A.2 Maintenance Criteria for Detention Ponds

**Table 6.15: Maintenance Criteria for Detention Ponds**

Maintenance Component	Defect	Conditions When Maintenance Is Needed	Results Expected When Maintenance Is Performed
<b>General</b>	Trash and Debris	Any trash and debris > 5 cubic feet (cf) per 1,000 square feet (sf), which is about equal to the amount of trash it would take to fill up one standard size garbage can. In general, there should be no visual evidence of dumping.  If less than threshold all trash and debris will be removed as part of next scheduled maintenance.	Trash and debris cleared from site.
	Poisonous Vegetation and Noxious Weeds	Any poisonous or nuisance vegetation which may constitute a hazard to maintenance personnel or the public.  Any evidence of noxious weeds as defined by State or local regulations.  (Apply requirements of adopted integrated pest management (IPM) policies for the use of herbicides).	No danger of poisonous vegetation where maintenance personnel or the public might normally be. (Coordinate with local health department).  Complete eradication of noxious weeds may not be possible. Compliance with State or local eradication policies required.
	Contaminants and Pollution	Any evidence of oil, gasoline, contaminants or other pollutants  (Coordinate removal/cleanup with local water quality response agency).	No contaminants or pollutants present.
	Rodent Holes	Any evidence of rodent holes if pond is acting as a dam or berm, or any evidence of water piping through dam or berm via rodent holes.	Rodents destroyed and dam or berm repaired. (Coordinate with local health department and Ecology Dam Safety Office if pond ≥ 10 acre-feet).
	Beaver Dams	Dam results in change or function of the pond.	Pond is returned to design function.  (Coordinate trapping of beavers and removal of dams with appropriate permitting agencies).
	Insects	When insects such as wasps and hornets interfere with maintenance activities.	Insects destroyed or removed from site.  Apply insecticides in compliance with adopted IPM policies.
	Tree Growth and Hazard Trees	Tree growth does not allow maintenance access or interferes with maintenance activity (i.e., slope mowing, silt removal, vacuuming, or equipment movements). If trees are not interfering with access or maintenance, do not remove  If dead, diseased, or dying trees are identified  (Use a certified arborist to determine health of tree or removal requirements)	Trees do not hinder maintenance activities. Harvested trees should be recycled into mulch or other beneficial uses (e.g., alders for firewood).  Remove hazard trees.
<b>Side Slopes of Pond</b>	Erosion	Eroded damage over 2 inches deep where cause of damage is still present or where there is potential for continued erosion.  Any erosion observed on a compacted berm embankment.	Slopes should be stabilized using appropriate erosion control measure(s); e.g., rock reinforcement, planting of grass, compaction.  If erosion is occurring on compacted berms a licensed engineer in the state of Washington should be consulted to resolve source of erosion.
<b>Storage Area</b>	Sediment	Accumulated sediment that exceeds 10% of the designed pond depth unless otherwise specified or affects inletting or outletting condition of the pond.	Sediment cleaned out to designed pond shape and depth; pond reseeded if necessary to control erosion.
	Liner	Liner is visible and has > three 0.25-inch holes in it.	Liner repaired or replaced. Liner is fully covered.

**Table 6.15: Maintenance Criteria for Detention Ponds (continued)**

Maintenance Component	Defect	Conditions When Maintenance Is Needed	Results Expected When Maintenance Is Performed
	(if applicable)		
<b>Pond Berms (Dikes)</b>	Settlements	Any part of berm which has settled 4 inches lower than the design elevation.  If settlement is apparent measure berm to determine amount of settlement.  Settling can be an indication of more severe problems with the berm or outlet works. A licensed engineer in the state of Washington should be consulted to determine the source of the settlement.	Dike is built back to the design elevation.
	Piping	Discernible water flow through pond berm. Ongoing erosion with potential for erosion to continue.  (Recommend a licensed engineer in the state of Washington with geotechnical expertise be called in to inspect and evaluate condition and recommend repair of condition.)	Piping eliminated. Erosion potential resolved.
<b>Emergency Overflow/Spillway</b>	Tree Growth	Tree growth on emergency spillways creates blockage problems and may cause failure of the berm due to uncontrolled overtopping.  Tree growth on berms > 4 feet in height may lead to piping through the berm which could lead to failure of the berm.	Trees should be removed. If root system is small (base < 4 inches) the root system may be left in place. Otherwise the roots should be removed and the berm restored. A licensed engineer in the state of Washington should be consulted for proper berm/spillway restoration.
	Piping	Discernible water flow through pond berm. Ongoing erosion with potential for erosion to continue.  (Recommend a licensed engineer in the state of Washington with geotechnical expertise be called in to inspect and evaluate condition and recommend repair of condition.)	Piping eliminated. Erosion potential resolved.
	Emergency Overflow/Spillway	Only one layer of rock exists above native soil in area $\geq 5$ sf, or any exposure of native soil at the top of outflow path of spillway.  (Riprap on inside slopes need not be replaced.)	Rocks and pad depth are restored to design standards.
	Erosion	See <a href="#">Side Slopes of Pond</a> .	

### 6.A.3 Maintenance Criteria for Detention Vaults/Tanks

**Table 6.16: Maintenance Criteria for Detention Vaults/Tanks**

Maintenance Component	Defect	Conditions When Maintenance Is Needed	Results Expected When Maintenance Is Performed
<b>Storage Area</b>	Plugged Air Vents	One-half the cross section of a vent is blocked at any point or the vent is damaged.	Vents open and functioning.
	Debris and Sediment	Accumulated sediment depth exceeds 10% of the diameter of the storage area for one-half the length of storage vault, or any point depth exceeds 15% of diameter.  (Example: 72-inch-diameter storage tank would require cleaning when sediment reaches depth of 7 inches, for > one-half length of the tank.)	All sediment and debris removed from storage area.
	Joints Between Tank/ Pipe Section	Any openings or voids allowing material to be transported into vault/tank.  (Will require engineering analysis to determine structural stability).	All joint between tank/pipe sections are sealed.
	Tank Pipe Bent out of Shape	Any part of tank/pipe is bent out of shape > 10% of its design shape. (Review required by a licensed engineer in the state of Washington to determine structural stability).	Tank/pipe repaired or replaced to design.
	Vault Structure Includes Cracks in Wall, Bottom, Damage to Frame and/or Top Slab	Cracks > 0.5 inches and any evidence of soil particles entering the structure through the cracks, or maintenance/inspection personnel determines that the vault is not structurally sound.	Vault replaced or repaired to design specifications and is structurally sound.
Cracks > 0.5 inches at the joint of any inlet/outlet pipe or any evidence of soil particles entering the vault through the walls.		No cracks > 0.25 inches wide at the joint of the inlet/outlet pipe.	
<b>Manhole</b>	Cover Not in Place	Cover is missing or only partially in place. Any open manhole requires maintenance.	Manhole is closed.
	Locking Mechanism Not Working	Mechanism cannot be opened by one maintenance person with proper tools. Bolts into frame have < 0.5 inches of thread (may not apply to self-locking lids).	Mechanism opens with proper tools.
	Cover Difficult to Remove	One maintenance person cannot remove lid after applying normal lifting pressure. Intent is to keep cover from sealing off access to maintenance.	Cover can be removed and reinstalled by one maintenance person.
	Ladder Rungs Unsafe	Ladder is unsafe due to missing rungs, misalignment, not securely attached to structure wall, rust, or cracks.	Ladder meets design standards. Allows maintenance person safe access.
<b>Catch Basins</b>	See criteria in <a href="#">Table 6.18: Maintenance Criteria for Catch Basins</a> .		

## 6.A.4 Maintenance Criteria for Control Structures

**Table 6.17: Maintenance Criteria for Control Structures**

Maintenance Component	Defect	Condition When Maintenance Is Needed	Results Expected When Maintenance Is Performed
General	Trash and Debris (includes sediment)	Material exceeds 25% of sump depth or 1 foot below orifice plate.	Control structure orifice is not blocked. All trash and debris removed.
	Structural Damage	Structure is not securely attached to manhole wall.	Structure securely attached to wall and outlet pipe.
		Structure is not in upright position (allow up to 10% from plumb).	Structure in correct position.
		Connections to outlet pipe are not watertight and show signs of rust.	Connections to outlet pipe are water tight; structure repaired or replaced and works as designed.
		Any holes—other than designed holes—in the structure.	Structure has no holes other than designed holes.
Clean-out Gate	Damaged or Missing	Clean-out gate is not watertight or is missing.	Gate is watertight and works as designed.
		Gate cannot be moved up and down by one maintenance person.	Gate moves up and down easily and is watertight.
		Chain/rod leading to gate is missing or damaged.	Chain is in place and works as designed.
		Gate is rusted > 50% of its surface area.	Gate is repaired or replaced to meet design standards.
Orifice Plate	Damaged or Missing	Control device is not working properly due to missing, out of place, or bent orifice plate.	Plate is in place and works as designed.
	Obstructions	Any trash, debris, sediment, or vegetation blocking the plate.	Plate is free of all obstructions and works as designed.
Overflow Pipe	Obstructions	Any trash or debris blocking (or having the potential of blocking) the overflow pipe.	Pipe is free of all obstructions and works as designed.
Manhole	See criteria for vaults/tanks in <a href="#">Table 6.16: Maintenance Criteria for Detention Vaults/Tanks</a> .		
Catch Basin	See criteria in <a href="#">Table 6.18: Maintenance Criteria for Catch Basins</a> .		

## 6.A.5 Maintenance Criteria for Catch Basins

**Table 6.18: Maintenance Criteria for Catch Basins**

Maintenance Component	Defect	Condition When Maintenance Is Needed	Results Expected When Maintenance Is Performed
General	Trash and Debris	Trash or debris which is located immediately in front of the catch basin opening or is blocking inletting capacity of the basin by > 10%.	No trash or debris located immediately in front of catch basin or on grate opening.
		Trash or debris (in the basin) that exceeds 60% of the sump depth as measured from the bottom of basin to invert of the lowest pipe into or out of the basin, but in no case < 6 inches clearance from the debris surface to the invert of the lowest pipe.	No trash or debris in the catch basin.
		Trash or debris in any inlet or outlet pipe blocking > one-third its height.	Inlet and outlet pipes free of trash or debris.
		Dead animals or vegetation that could generate odors that could cause complaints or dangerous gases (e.g., methane).	No dead animals or vegetation present within the catch basin.
	Sediment	Sediment (in the basin) that exceeds 60% of the sump depth as measured from the bottom of basin to invert of the lowest pipe into or out of the basin, but in no case < 6 inches clearance from the sediment surface to the invert of the lowest pipe.	No sediment in the catch basin

**Table 6.18: Maintenance Criteria for Catch Basins (continued)**

Maintenance Component	Defect	Condition When Maintenance Is Needed	Results Expected When Maintenance Is Performed
		Measured from the bottom of basin to invert of the lowest pipe into or out of the basin.	
	Structure Damage to Frame and/or Top Slab	Top slab has holes larger than 2 square inches or cracks > 0.25 inches. (Intent is to make sure no material is running into basin).	Top slab is free of holes and cracks.
		Frame not sitting flush on top slab, i.e., separation of > 0.75 inches of the frame from the top slab. Frame not securely attached.	Frame is sitting flush on the riser rings or top slab and firmly attached.
	Fractures or Cracks in Basin Walls/Bottom	Maintenance person judges that structure is unsound.	Basin replaced or repaired to design standards.
		Grout fillet has separated or cracked > 0.5 inches and longer than 1 foot at the joint of any inlet/outlet pipe or any evidence of soil particles entering catch basin through cracks.	Pipe is regouted and secure at basin wall.
	Settlement/Misalignment	If failure of basin has created a safety, function, or design problem.	Basin replaced or repaired to design standards.
	Vegetation	Vegetation growing across and blocking > 10% of the basin opening.	No vegetation blocking opening to basin.
		Vegetation growing in inlet/outlet pipe joints that is > 6 inches tall and < 6 inches apart.	No vegetation or root growth present.
	Contamination and Pollution	See <a href="#">Table 6.15: Maintenance Criteria for Detention Ponds</a> .	No pollution present.
Catch Basin Cover	Cover Not in Place	Cover is missing or only partially in place. Any open catch basin requires maintenance.	Catch basin cover is closed
	Locking Mechanism Not Working	Mechanism cannot be opened by one maintenance person with proper tools. Bolts into frame have < 0.5 inches of thread.	Mechanism opens with proper tools.
	Cover Difficult to Remove	One maintenance person cannot remove lid after applying normal lifting pressure. (Intent is keep cover from sealing off access to maintenance.)	Cover can be removed by one maintenance person.
Ladder	Ladder Rungs Unsafe	Ladder is unsafe due to missing rungs, not securely attached to basin wall, misalignment, rust, cracks, or sharp edges.	Ladder meets design standards and allows maintenance person safe access.
Metal Grates (if applicable)	Grate opening Unsafe	Grate with opening > 7/8 inches.	Grate opening meets design standards.
	Trash and Debris	Trash and debris that is blocking > 20% of grate surface inletting capacity.	Grate free of trash and debris.
	Damaged or Missing	Grate missing or broken member(s) of the grate.	Grate is in place and meets design standards.

*This page has been intentionally left blank for double-sided printing.*

## 6.A.6 Maintenance Criteria for Drywells

The structural life of a drywell is approximately 20 years, although hydraulic failure could potentially occur at any time. Drywell performance is dependent on proper installation, regularly scheduled maintenance and contaminants reaching the drywell. The following schedule is recommended as a guide; actual schedule may need to be varied based on observed performance.

**Table 6.19: Maintenance Criteria for Drywells**

Maintenance Interval	Description of Maintenance to Be Performed
Every 3 months	Visually inspect
Every 6 months	Remove debris and sediment
Annually	Check for structural damage
<b>Whichever Is More Frequent: Above Schedule or Below Observed Events:</b>	
Following substantial (> 24-hour) rainfall event	If possible, observe drywells in operation during the rainfall event. Aim to identify and correct problem prior to failure.
Following intense but short-duration event	
Following snowmelt event	It is especially important to observe the drywells if the melt occurred concurrently with frozen ground conditions.

### Definitions of Maintenance Tasks

#### Visual Inspection

Ensure metal grate and drywell are free of debris and obstructions. Remove any debris from on top of or around drywell and grate. Remove grate and inspect drywell for debris and sediment buildup in the barrel. Debris needs to be removed immediately, if possible. Sediment needs to be cleaned out before depth reaches the lowest row of slots providing outflow from drywell barrel.

Anytime that standing water is noticed in a drywell > 24 hours after an event has ceased, a visual inspection is warranted. When standing water is observed, the inspector should be aware of any signs of illicit discharge. If any of the following are observed, in addition to the sod and topsoil being affected and requiring replacement, if it is evident that discharge was made directly into the drywell, the drywell and affected surrounding drain rock must be replaced as soon as possible: oil sheen, spilled paint, burned area due to battery acid, multicolored appearance of antifreeze, brown to black fuel oil, or any other materials that may be deemed deleterious to water quality. Sod, topsoil and drain rock removed must be handled and disposed of in a manner consistent with a hazardous material.

#### **Remove Debris and Sediment**

Remove any large debris that would interfere with the Vactoring (suction removal) of the drywell. Sediment must be completely suctioned out of the drywell barrel. Care should be taken to note the depth of the sediment. If it appears that the sediment is increasing with depth at each inspection, this

may be a sign that the swale is not functioning properly; stormwater may be ponding and spilling, carrying sediment laden stormwater into the drywell, rather than infiltrating at the design rate.

### ***Check for Structural Damage***

Inspect metal frame and grate, adjustment rings, mortar or any other visible parts of the drywell structure. The metal frame and grate should sit flush on the top ring. Any separation of  $\geq 0.75$  inches must be adjusted and repaired. The drywell should be replaced or repaired to design standards if it has settled  $> 2$  inches or if standing water fails to drain out of the barrel slots. Adjustment rings should be free of cracks. Crack repair should adhere be performed when:

<b>Location of Crack</b>	<b>Maximum Width of Crack</b>
Top ring of drywell	0.25 inches
Drywell barrel	0.5 inches and longer than 3 feet
Drywell floor	0.5 inches and longer than 1 foot

**Note:** Any crack, regardless of location or width, in which sediment is observed, needs to be repaired as soon as possible. Cracks should be repaired with mortar similar to that used between the adjustment rings. Mortar or grout should be waterproof and of the nonshrink variety.



## 6.A.7 Maintenance Criteria for Infiltration Ponds

**Table 6.20: Maintenance Criteria for Infiltration Ponds**

Maintenance Component	Defect	Condition When Maintenance Is Needed	Results Expected When Maintenance Is Performed
<b>General</b>	Trash and Debris	See <a href="#">Table 6.15: Maintenance Criteria for Detention Ponds</a>	See <a href="#">Table 6.15: Maintenance Criteria for Detention Ponds</a>
	Poisonous/ Noxious Vegetation	See <a href="#">Table 6.15: Maintenance Criteria for Detention Ponds</a>	See <a href="#">Table 6.15: Maintenance Criteria for Detention Ponds</a>
	Contaminants and Pollution	See <a href="#">Table 6.15: Maintenance Criteria for Detention Ponds</a>	See <a href="#">Table 6.15: Maintenance Criteria for Detention Ponds</a>
	Rodent Holes	See <a href="#">Table 6.15: Maintenance Criteria for Detention Ponds</a>	See <a href="#">Table 6.15: Maintenance Criteria for Detention Ponds</a>
<b>Storage Area</b>	Sediment	Water ponding in infiltration pond after rainfall ceases and appropriate time allowed for infiltration. (A percolation test pit or test of pond indicates pond is only working at 90% of its designed capabilities. If 2 inches of sediment or more is present, remove).	Sediment is removed and/or pond is cleaned so that infiltration system works according to design.
<b>Filter Bags if applicable</b>	Filled With Sediment and Debris	Sediment and debris fill bag > one-half full.	Filter bag is replaced or system is redesigned.
<b>Rock Filters</b>	Sediment and Debris	By visual inspection, little or no water flows through filter during heavy rain storms.	Gravel in rock filter is replaced.
<b>Side Slopes of Pond</b>	Erosion	See <a href="#">Table 6.15: Maintenance Criteria for Detention Ponds</a>	See <a href="#">Table 6.15: Maintenance Criteria for Detention Ponds</a>
<b>Emergency Overflow Spillway and Berms &gt;4 Feet in Height</b>	Tree Growth	See <a href="#">Table 6.15: Maintenance Criteria for Detention Ponds</a>	See <a href="#">Table 6.15: Maintenance Criteria for Detention Ponds</a>
	Piping	See <a href="#">Table 6.15: Maintenance Criteria for Detention Ponds</a>	See <a href="#">Table 6.15: Maintenance Criteria for Detention Ponds</a>
<b>Emergency Overflow Spillway</b>	Rock Missing	See <a href="#">Table 6.15: Maintenance Criteria for Detention Ponds</a>	See <a href="#">Table 6.15: Maintenance Criteria for Detention Ponds</a>
	Erosion	See <a href="#">Table 6.15: Maintenance Criteria for Detention Ponds</a>	See <a href="#">Table 6.15: Maintenance Criteria for Detention Ponds</a>
<b>Presettling Ponds and Vaults</b>	Pond or Sump Filled With Sediment and/or Debris	6 inches or designed sediment trap depth of sediment.	Sediment is removed.

## 6.A.8 Maintenance Criteria for Evaporation Ponds

**Table 6.21: Maintenance Criteria for Evaporation Ponds**

Maintenance Component	Defect	Condition When Maintenance is Needed	Results Expected When Maintenance is Performed
<b>General</b>	Trash and Debris	See <a href="#">Table 6.15: Maintenance Criteria for Detention Ponds</a>	See <a href="#">Table 6.15: Maintenance Criteria for Detention Ponds</a>
	Poisonous/ Noxious Vegetation	See <a href="#">Table 6.15: Maintenance Criteria for Detention Ponds</a>	See <a href="#">Table 6.15: Maintenance Criteria for Detention Ponds</a>
	Contaminants and Pollution	See <a href="#">Table 6.15: Maintenance Criteria for Detention Ponds</a>	See <a href="#">Table 6.15: Maintenance Criteria for Detention Ponds</a>
	Rodent Holes	See <a href="#">Table 6.15: Maintenance Criteria for Detention Ponds</a>	See <a href="#">Table 6.15: Maintenance Criteria for Detention Ponds</a>
<b>Side Slopes of Pond</b>	Erosion	See <a href="#">Table 6.15: Maintenance Criteria for Detention Ponds</a>	See <a href="#">Table 6.15: Maintenance Criteria for Detention Ponds</a>

**Table 6.21: Maintenance Criteria for Evaporation Ponds (continued)**

Maintenance Component	Defect	Condition When Maintenance is Needed	Results Expected When Maintenance is Performed
Storage Area	Sediment	Accumulated sediment that exceeds 10% of the designed pond depth unless otherwise specified or affects inletting or outletting condition of the pond.	Sediment cleaned out to designed pond shape and depth; pond reseeded if necessary to control erosion.
	Liner (if applicable)	Liner is visible and has > three 0.25-inch holes in it.	Liner repaired or replaced. Liner is fully covered.
Pond Berms (Dikes)	Settlements	Any part of berm which has settled 4 inches lower than the design elevation. If settlement is apparent, measure berm to determine amount of settlement. Settling can be an indication of more severe problems with the berm or outlet works. A licensed engineer in the state of Washington should be consulted to determine the source of the settlement.	Dike is built back to the design elevation.
	Piping	Discernable water flow through pond berm. Ongoing erosion with potential for erosion to continue.  (Recommend a licensed engineer in the state of Washington with geotechnical expertise be called in to inspect and evaluate condition and recommend repair of condition.	Piping eliminated. Erosion potential resolved.
General	Inlet Pipe	Inlet pipe clogged with sediment and/or debris material.	No clogging or blockage in the inlet and outlet piping.
	Oil Sheen on Water	Prevalent and visible oil sheen.	Oil removed from water using oil-absorbent pads or Vactor truck. Source of oil located and corrected. If chronic low levels of oil persist, plant wetland plants such as <i>Juncus effusus</i> (soft rush) which can uptake small concentrations of oil.
	Erosion	Erosion of the pond's side slopes and/or scouring of the pond bottom that exceeds 6 inches, or where continued erosion is prevalent.	Slopes stabilized using proper erosion control measures and repair methods.
	Overflow Spillway	Rock is missing and soil is exposed at top of spillway or outside slope.	Rocks replaced to specifications.
	Snow	Snow removal operations deposit snow into evaporation pond.	This added factor must be considered in the water budget, especially if snow from another basin is put into the system. Temporary sediment ponds should be included in the design, to prevent sediment-laden runoff from entering the pond and storm disposal system during construction.

## 6.A.9 Maintenance Criteria for Rainwater Harvesting

**Table 6.22: Maintenance Criteria for Rainwater Harvesting**

Activity	Objective	Schedule
<b>Remove debris from roof:</b> Sweep, rake or use leaf blower.	Prevent debris from entering collection and filter system	Determined by inspection
<b>Clean gutters:</b> By hand or use leaf blower.	Prevent debris from entering collection and filter system	Determined by inspection (generally September, November, January, and April). The most critical cleaning is in mid-spring to late spring to flush the pollen deposits from surrounding trees. <sup>a</sup>
<b>Clean downspout basket screens:</b> Remove debris from screens at top of downspout.	Prevent debris from entering collection and filter system, and clogging of system	Same as gutters
<b>Clean prefilters</b>	Prevent debris from entering collection and filter system, and clogging of system	Monthly
<b>Clean storage tanks of debris:</b> Drain tank and remove debris from bottom of tank.	Prevent contamination	Determined by inspection
<b>Clean particle filters</b>	Prevent contamination	6 months or determined by pressure drop in system.
<b>Clean and replace ultraviolet (UV) filters</b>	Prevent contamination	Clean every 6 months and replace bulb every 12 months or according to manufacturer's recommendation.
<b>Chlorinate storage tank:</b> Chlorinate to 0.2 to 0.5 parts per million (ppm) (0.25 cup of household bleach [5.25%] at the rate of 1 cup of bleach to 1,000 gallons of stored water)	Prevent contamination	Quarterly
<b>Flush household taps:</b> Remove carbon filter and flush until chlorine odor is noticed at taps. Chlorinated water should be left standing in the piping for 30 minutes. Replace the carbon filter.	Prevent contamination	When storage tanks are cleaned
<sup>a</sup> Covers for gutters may be appropriate for specific locations, but can make regular cleaning more difficult and will not prevent pollen from entering filter system.		

## 6.A.10 Maintenance Criteria for Permeable Pavement

**Table 6.23: Maintenance Criteria for Permeable Pavement**

Maintenance Component	Activity	Objective	Schedule	Notes
<b>Routine Maintenance</b>				
<b>All Permeable Paving Surfaces</b>	<b>Erosion and sediment control:</b> Mulch and/or plant all exposed soils that may erode to paving installation.	Minimize sediment inputs to pavement, reduce clogging and maintain infiltration of pavement.	Once annually	Erosion control is critical for long-term performance of permeable paving.
<b>Porous Asphalt or Pervious Concrete</b>	<b>Clean permeable pavement installation:</b> Use street cleaning equipment with suction, sweeping and suction or high-pressure wash and suction.	Maintain infiltration capability	Once or twice every year	Street cleaning equipment using high-pressure wash with suction provides the best results for improving infiltration rates. Sweeping with suction provides adequate results and sweeping alone is minimally effective. Handheld pressure washers are effective for cleaning void spaces and appropriate for smaller areas such as sidewalks (may require special spray nozzle).
<b>Eco-Stone Pavers</b>	<b>Clean permeable pavement installation:</b> Use street cleaning equipment with sweeping and suction when surface and debris are dry.	Maintain infiltration capability	Once annually	Washing should not be used to remove debris and sediment in the openings between the pavers. Vacuum settings may have to be adjusted to prevent excess uptake of aggregate from paver openings or joints.
<b>All Permeable Paving Surfaces</b>	<b>Backfill utility cuts:</b> Use same aggregate base as under permeable paving.	Maintain conveyance of stormwater through base and prevent migration of fines from standard base aggregate to the more open graded permeable pavement base material.	Determined by inspection	Small utility cuts can be repaired with permeable top course or with conventional asphalt or concrete if small batches of permeable material are not available or are too expensive.
	<b>Replace aggregate in paver cells:</b> Remove aggregate with suction equipment.	Maintain infiltration capacity	Determined by inspection	Clogging is usually an issue in the upper most few centimeters of aggregate. Check infiltration at various depths in the aggregate profile to determine excavation depth.
	<b>Utility maintenance:</b> Remove pavers individually by hand and replaced when utility work is complete.	Repair utilities, maintain structural integrity of pavement.	When maintaining utilities	Pavers can be removed individually and replaced when utility work is complete.
	<b>Replace broken pavers:</b> Remove individual pavers by hand and replace.	Maintain structural integrity of pavement.	Determined by inspection	
<b>Nonroutine Maintenance</b>				
<b>Gravelpave 2</b>	<b>Clean permeable pavement installation:</b> Use vacuum trucks for storm drains to remove and replace top course aggregate if clogged with sediment or contaminated.	Restore infiltration capability	Determined by inspection	Permeable gravel pavement systems have a very high void to surface coverage ratio. System failure due to clogging is unlikely except in unusual circumstances.
	<b>Replenish aggregate material:</b> Spread gravel with rake.	Maintain structural integrity	Determined by inspection	Gravel level should be maintained at the same level as the plastic rings or slightly above the top of rings. In high traffic areas, such as aisle ways, entrances or exits, gravel may become compacted or transported.
	<b>Remove and replace grid segments:</b> Remove pins, pry up grid segments, replace gravel.	Maintain structural integrity	Determined by inspection	Replace grid segments where three or more adjacent rings are broken or damaged. Potholes should be remedied in the same way; the base course should be brought to the proper grade and compaction before replacing grid.
<b>Grasspave2</b>	<b>Aeration:</b> See Notes.			<b>Do not aerate Grasspave 2 installations.</b> Aeration equipment will damage the structure of Grasspave2 and could prevent its long-term function. Soil compaction and poor water penetration can be the result of soil

**Table 6.23: Maintenance Criteria for Permeable Pavement (continued)**

Maintenance Component	Activity	Objective	Schedule	Notes
				types or local conditions and should be treated accordingly.
	<b>Replace Grasspave2 installation:</b> Place units over porous gravel base, fill with grass.	Restore system capability	Determined by inspection	Do not place any form of topsoil between sandy gravel base and Grasspave2 units.
	<b>Invasive or nuisance plants:</b> Remove manually and without herbicide applications.	Promote selected plant growth and survival, maintain aesthetics	Twice annually	At a minimum, schedule weeding with inspections to coincide with important horticultural cycles (e.g., prior to major weed varieties dispersing seeds).
	<b>Fertilization:</b> If necessary apply by hand. See Notes.	Plant growth and survival	Determined by inspection	Installations should be designed to not require fertilization after plant establishment. If fertilization is necessary during plant establishment or for plant health and survivability after establishment, use an encapsulated, slow release fertilizer (excessive fertilization can contribute to increased nutrient loads in the stormwater system and receiving waters).
	<b>Irrigate:</b> Use subsurface or drip irrigation.		Determined by inspection and only when absolutely necessary for plant survival.	Surface irrigation systems can promote weed establishment, root development near the drier surface layer of the soil substrate, and increase plant dependence on irrigation. Accordingly, subsurface irrigation methods are preferred. If surface irrigation is the only method available, use drip irrigation to deliver water to the base of the plant.
	<b>Replace permeable pavement material</b>	Maintain infiltration and stormwater storage capability	Determined by inspection	If BMP is designed, installed and maintained properly, permeable pavement should last as long as conventional pavement.

**6.A.11 Maintenance Criteria for Amended Construction Site Soils**

**Table 6.24: Maintenance Criteria for Amended Construction Site Soils**

Maintenance Component	Activity	Objective	Schedule	Notes
<b>Routine Maintenance</b>				
<b>General</b>	Add compost or mulch: Spread material by hand to minimize damage to plant material.	Maintain organic matter content of soil, optimize soil moisture retention, prevent erosion, and enhance plant growth and survivability.	Once every 1 or 2 years	Compost amended landscapes are stormwater management BMPs and pesticide inputs should be eliminated or used only in unusual circumstances. Landscape management personnel should be trained to adjust chemical applications accordingly.

## 6.A.12 Maintenance Criteria for Vegetated Roofs

**Table 6.25: Maintenance Criteria for Vegetated Roofs**

Maintenance Component	Activity	Objective	Schedule	Notes
<b>Routine Maintenance</b>				
<b>Structural and Drainage Components</b>	<b>Clear inlet pipes:</b> Remove soil substrate, vegetation or other debris.	Maintain free drainage of inlet pipes	Twice annually	
	<b>Inspect drain pipe:</b> Check for cracks settling and proper alignment, and correct and recompact soils or fill material surrounding pipe, if necessary.	Maintain free drainage of inlet pipes	Twice annually	
	<b>Inspect fire ventilation points for proper operation</b>	Fire and safety	Twice annually	
	<b>Maintain egress and ingress:</b> Clear routes of obstructions and maintained to design standards.	Fire and safety	Twice annually	
	<b>Insects:</b> See Notes			Vegetated roof design should provide drainage rates that do not allow pooling of water for periods that promote insect larvae development. If standing water is present for extended periods correct drainage problem. Chemical sprays should not be used.
	<b>Prevent release of contaminants:</b> Identify activities (mechanical systems maintenance, pet access, etc.) that can potentially release pollutants to the vegetated roof and establish agreements to prevent release.	Water quality protection	During construction of roof and then as determined by inspection	Any cause of pollutant release should be corrected as soon as identified and the pollutant removed.
<b>Vegetation and Growth Medium</b>	<b>Invasive or nuisance plants:</b> Remove manually and without herbicide applications.	Promote selected plant growth and survival, maintain aesthetics	Twice annually	At a minimum, schedule weeding with inspections to coincide with important horticultural cycles (e.g., prior to major weed varieties dispersing seeds).
	<b>Removing and replacing dead material:</b> See Notes	See Notes	Once annually	Normally, dead plant material will be recycled on the roof; however specific plants or aesthetic considerations may warrant removing and replacing dead material (see manufacturer's recommendations).
	<b>Fertilization:</b> If necessary apply by hand. See Notes.	Plant growth and survival	Determined by inspection	Extensive vegetated roofs should be designed to not require fertilization after plant establishment. If fertilization is necessary during plant establishment or for plant health and survivability after establishment, use an encapsulated, slow release fertilizer (excessive fertilization can contribute to increased nutrient loads in the stormwater system and receiving waters).
	<b>Mulching:</b> See Notes			Avoid application of mulch on extensive vegetated roofs. Mulch should be used only in unusual situations and according to the vegetated roof provider guidelines. In conventional landscaping mulch enhances moisture retention; however, moisture on a vegetated roof should be controlled by proper design of the soil/growth medium. Mulch will also increase establishment of weeds.
	<b>Irrigate:</b> Use subsurface or drip irrigation		Determined by inspection and only when necessary for plant survival	Surface irrigation systems on extensive vegetated roof can promote weed establishment, root development near the drier surface layer of the soil substrate, and increase plant dependence on irrigation. Accordingly, subsurface irrigation methods are preferred. If surface irrigation is the only method available, use drip irrigation to deliver water to the base of the plant.

## **Appendix 6-B: Guidelines for Site Characterization of Geotechnical Properties**

### **6.B.1 Geotechnical Site Characterization**

Geotechnical site characterization should be conducted to demonstrate the site's general suitability for on-site stormwater disposal. The scope of the investigation should consist of, but not be limited to, the following elements:

1. Review applicable geologic maps of the site area, to identify geologic conditions that could impact the feasibility of storm drainage disposal systems. This may include outcropping/shallow low-permeability bedrock, surficial low-permeability sediment, borrow pits, and/or shallow ground water conditions.
2. Site explorations should consist of one exploratory test pits or borings per every 15,000 square feet (sf) of the disposal area or 200 linear feet of roadway, but not less than three explorations. The explorations should be completed on the site and specifically in the planned disposal area. The explorations should extend to a depth (H) plus 5 feet below the bottom of the proposed Best Management Practice (BMP), where H is equivalent to the maximum head of water within the BMP. Deeper site exploration (up to 50 feet in depth) may be needed if subsurface information, such as existing water well or resource protection well logs, is not available.
3. Samples recovered from the site exploration work may be tested to assess gradational characteristics to help verify the soil classification for comparison with the mapped soil unit.
4. Include a surface reconnaissance of surrounding properties, particularly in the anticipated downgradient ground water flow direction, to assess potential impact of additional ground water.
5. Perform laboratory testing to determine Unified Soil Classification Group Symbol and Group Name of the site soils (e.g., ASTM C136/D442; ASTM C117/D1140; and ASTM D4318).
6. Provide a summary report, describing the results of the work. Include a vicinity map, an exploration site plan, and laboratory test results. Include information regarding the depth to ground water and the presence of any limiting layers which may control ground water flow. Consider feasibility and limitations for on-site disposal. Include information on how the field permeability testing was performed and the assumptions made for determining the recommended infiltration rate. The report shall be prepared by or under the direction of a licensed engineer in the state of Washington with geotechnical expertise and appropriately signed and sealed.

### **6.B.2 Required Minimum Permeability for Use With Standard Drywell Practice**

Spokane County Standard Type "A" or Type "B" drywells discharging at assumed rates of 0.3 and 1.0 cubic feet per second (cfs), respectively, are allowed in soil groups other than Springdale and Garrison provided the other standard drywell practice conditions are met, and the soil surrounding

the drywell has a minimum permeability of  $2.5 \times 10^{-2}$  centimeters per second (cm/sec) (35 inches per hour [in/hr]), when tested in accordance with the field procedures outlined in this appendix.

### **Derivation of Minimum Permeability (“k”) Value**

This minimum required value is based on modeling the drywell as a reverse well and applying an equation presented in U.S. Bureau of Reclamation (USBR) Test Procedure 7300-89 that relates outflow rate from an injection well under constant-head conditions to soil permeability and other well geometric properties.

The derivation of this rate is presented on the following page of this appendix.

Please note that permeability (k) as used in this section is equivalent to hydraulic conductivity (with units of length/time) and is provided in the context of Darcy’s Equation that describes flow through porous media:

### **Equation 6.12: Darcy's Equation**

$$Q = k \cdot I \cdot A$$

where:

Q = flow rate (cfs)

k = permeability (feet per second [ft/sec])

I = hydraulic gradient (ft)

A = cross-sectional area of flow (square feet ;sf)

Also please note the difference between permeability (k) as described above and the soil infiltration rate (I). Within the context of this appendix, infiltration rate (I), is used to indicate a volumetric flow rate moving across unit surface area perpendicular to flow direction (i.e., cfs/sf).

### **$2.5 \times 10^{-2}$ cm/sec Threshold Permeability Criterion Derivation**

Basis for  $2.5 \times 10^{-2}$  cm/sec (35 in/hr) minimum permeability criterion for standard drywells.

Given: Wetted perimeter of Type B standard drywell with 10-foot bore depth is approximately 600 sf, (per Spokane County calculation circa 1992).

USBR Equation for Condition I (thickness of unsaturated strata  $> 3H$ , where H is the height of the water in the drywell).

The design equation is:

### **Equation 6.13: USBR Equation for Condition I**

$$k = \frac{q}{2\pi \cdot H^2} \left( \ln \left[ \frac{H}{r} + \sqrt{\left(\frac{H}{r}\right)^2 + 1} \right] - \frac{\sqrt{1 + \left(\frac{H}{r}\right)^2}}{H/r} + \frac{1}{H/r} \right)$$

where:



k = permeability (ft/sec)

q = constant inflow (cfs)

H = height of the water in the drywell (ft)

r = effective radius (ft)

A standard Type B drywell installation, with an inverted conical envelope of drainage gravel provides approximately 600 sf of side slope infiltration area. An equivalent cylindrical surface, having a side area of 600 sf and a 10-foot depth, would require an effective radius (r) of about 9.5 feet.

Using these parameters, the minimum required permeability (k) for q = 1 cfs is:

$$7.8 \times 10^{-4} \text{ ft/sec} = 2.4 \times 10^{-2} \text{ cm/sec}$$

### **6.B.3 Recommended Field Test Procedures**

Five standard field test methods are discussed in this section, listed below. Local jurisdictions might allow other field test methods to be used within the areas they administer. See [Table 6.3: Infiltration Testing and Evaluation Methods](#) for the advantages, disadvantages, and applicability of each field test method. The hydraulic terms (e.g., permeability, hydraulic conductivity, and infiltration rate) associated with each method described below have been retained from the source of the method description.

- Borehole methods, for estimating permeability
- Single-ring infiltrometer, for estimating infiltration rate
- Constant-head conditions, for estimating outflow rate
- Small-scale pilot infiltration test (PIT), for estimating saturated hydraulic conductivity
- Large-scale PIT, for estimating saturated hydraulic conductivity

### ***Estimating Field Permeability of Soil-in-Place Using Borehole Methods***

**(February 6, 1996)**

#### **Applicability**

This test method is applicable for determining permeabilities for use in the design of standard and nonstandard systems using drywells. Note: Design deviation is required for all nonstandard subsurface disposal systems.

#### **Method**

1. Using a hollow-stem auger, advance a 6-inch-diameter or greater borehole to a depth of 2 to 5 feet below the anticipated elevation of the proposed drainage structure. Use care not to contaminate the sides of the hole with fines.
2. Install a slotted pipe or well screen into the hole having a minimum diameter of 2 inches and a

minimum 20% open area through the hollow-stem portion of the auger-string. Install the pipe as nearly as is practical to the bottom of the hole. Wrapping the pipe with a highly porous, nonwoven, geotextile fabric is an allowable practice.

3. During auger removal, install a gravel-pack of uniform, clean, dry, pervious fine gravel around the slotted pipe. Omission of this step is an allowable practice. However, calculations for permeability must be based on the original diameter of the borehole, therefore omission of the gravel pack is not recommended.
4. Introduce clean water near the bottom of the hole through the slotted pipe using an in-line, commercially available, flow meter. Prior to the test, field check the accuracy of the flow meter using a suitable container of known volume (i.e., 5-gallon bucket, etc.).
5. Raise the water level in the hole until a level consistent with the operating head anticipated in the proposed drainage structure is achieved. Based on the soil permeability, the subsurface soil profile, and the water supply system available, head levels lower than those anticipated in the drainage structure are permitted.
6. Adjust the flow rate as needed to maintain the constant-head level in the hole. Minimum required time for this step is 1 hour.
7. Monitor and record the flow rate required to maintain the constant-head level at appropriate intervals. In no case shall the interval > 10 minutes.
8. Continue maintaining a constant-head level until a stabilized flow rate has been achieved. Consider the flow rate stable when the incremental flow rate required to maintain the head does not vary by > 5% between increments. The intent of this step is to achieve a relatively steady-state flow condition between the minimum time of 1 hour and a maximum time of 1.5 hours for this step. At the discretion of the qualified professional, the time for this step may be extended beyond the 1.5-hour maximum.
9. Upon completion of the constant-head period, discontinue flow, and monitor the decrease in head level in the borehole at appropriate intervals over  $\geq$  30-minute falling-head period.
10. Compute the permeability for the constant-head portion of the test using methods outlined in U.S. Bureau of Reclamation (USBR) Procedure 73000-89, Performing Field Permeability Testing by the Well Permeameter Method; and USBR Procedure 7305-89, Field Permeability Test (Shallow-Well Permeameter Method). Note: Use stabilized flow rates observed near the end of the constant-head period in the permeability calculations.
11. Apply a correction factor ([6.3.3 General Criteria for Infiltration BMPs](#)) to the permeability estimate based on test method.
12. At a minimum, the test report shall include a description of the equipment used to conduct the test (including type of flow meter used and the results of the on-site accuracy check of the flow meter); difficulties encountered during drilling and testing; a subsurface log of the soils encountered; depth and diameter of the borehole; type of gravel-pack used (including visual description); type of slotted pipe used; raw data for both constant- and falling-head periods including flow meter readings, incremental flow rates and observed head levels; and calculations showing how the reported permeability rates were computed.

## ***Estimating Surface Infiltration Rate and Field Permeability Rate Using Single-Ring Infiltrometer Methods***

**(February 6, 1996)**

### **Applicability**

Test method is applicable for estimating infiltration and permeability rates for surficial soils in conjunction with nonstandard, subsurface disposal systems incorporating infiltration ponds.

**Note:** Design deviation is required for all nonstandard subsurface disposal systems.

### **Method**

1. Drive, jack, or hand-advance a short section of steel or polyvinyl chloride (PVC) pipe having a minimum inside diameter of approximately 12 inches, and a beveled leading edge into the soil surface to a depth of about 8 inches. If after installation the surface of the soil surrounding the wall of the ring shows signs of excessive disturbance such as extensive cracking or heaving, reset the ring at another location using methods that will minimize the disturbance. If the surface of the soil is only slightly disturbed, tamp the soil surrounding the inside and outside wall of the ring until it is as firm as it was prior to disturbance.
2. Introduce clean water into the ring using an in-line, commercially available, flow meter. Prior to the test, field check the accuracy of the flow meter using a suitable container of known volume (i.e., 5-gallon bucket, etc.). Use some form of splash-guard or diffuser apparatus such as a highly porous, nonwoven, geotextile fabric or a sheet of thin aluminum plate to prevent erosion of the surface of the soil during filling and testing.
3. Raise the water level in the ring until a head-level of  $\geq 6$  inches above the soil surface is achieved.
4. Adjust the flow rate as needed to maintain the constant-head level in the ring. Minimum required time for this step is 2 hours.
5. Monitor and record the flow rate required to maintain the constant-head level at appropriate intervals. In no case shall the interval  $> 10$  minutes.
6. Continue maintaining the constant-head level until a stabilized flow rate has been achieved. Consider the flow rate stable when the incremental flow rate required to maintain the head does not vary by  $> 5\%$  between increments. The intent of this step is to achieve a relatively steady-state flow condition between the minimum 2-hour test time and a maximum test time of 2.5 hours. At the discretion of the qualified professional, the test may be extended beyond the 2.5-hour maximum.
7. Upon completion of the constant-head period, discontinue flow, and monitor the decrease in head level in the ring at appropriate intervals over  $\geq 30$ -minute falling-head period.
8. Compute the surface infiltration rate using the equation:

### **Equation 6.14: Surface Infiltration Rate (Single-Ring Infiltrometer)**

$$I = Q/A$$

where:

I = surface infiltration rate (inches per hour [in/hr])

Q = flow rate required to maintain the constant-head (cubic inches per hour)

A = surface area of the soil inside the infiltrometer ring (square inches)

Use stabilized flow rates observed near the end of the constant-head period to compute the rate.

9. Compute the permeability rate using the following equation:

**Equation 6.15: Permeability Rate (Single-Ring Infiltrometer)**

$$K = \frac{Q * L}{A * H}$$

where:

k = permeability (in/hr)

Q = flow rate required to maintain a constant-head level (cubic inches/hour)

L = length of soil column contained within the ring (inches)

A = area of the ring (square inches)

H = head level measured from the base of the ring to the free water surface (inches)

This equation is based on information presented in the U.S. Bureau of Reclamation *Drainage Manual* ([USBR, 1993](#)). Use stabilized flow rates observed near the end of the constant-head period to compute the rate.

10. Apply a correction factor ([6.3.3 General Criteria for Infiltration BMPs](#)) to the permeability estimate based on test method.
11. At a minimum, the test report shall include a description of the equipment used to conduct the test (including type of flow meter used and the results of the on-site, flow meter accuracy check); a subsurface log of the soils encountered (if test was conducted in the bottom of a test pit), difficulties encountered during testing; raw data for both constant and falling-head periods including flow meter readings, incremental flow rates, and observed head levels; and calculations showing how the infiltration and permeability rates were computed.

## ***Estimating Outflow Rate From a Drywell Under Full-Scale, Constant-Head Conditions***

**(February 6, 1996)**

### **Applicability**

This test method is applicable for confirmation of design outflow rates for newly installed standard and nonstandard drywells.

### **Method**

1. Inspect the drywell and make a thorough report of its condition. At a minimum include information on any silt buildup; if there is any standing water in the drywell; whether it is interconnected to other drywells or catch basins by pipes; the overall depth of the drywell from finished grate elevation to bottom; the distance from finished grate elevation to the invert elevation of any interconnecting pipes; the length of the active barrel section. The active barrel section is defined as the length of ported sections from the bottom of the drywell up to the elevation of the base of the solid cone section. Include additional information as is applicable (i.e., age of the drywell, if it appears to have been heavily impacted by unusual factors such as construction practices, etc.).
2. Introduce clean water into the drywell using a calibrated, in-line commercially available flow meter.
3. Raise the water level in the drywell until it reaches the top of the active barrel section and then maintain it at that elevation. In the case of drywells interconnected by pipes, raise the water level to the invert elevation of the connecting pipe, or use an expandable pipe plug to seal the connecting pipe.
4. Adjust the flow rate as needed to maintain the constant-head level in the hole. Minimum required time for this step is 1 hour. Test time begins after the water level in the drywell has reached the top of the active barrel section, or the invert elevation of any interconnecting pipes.
5. Monitor the flow rate required to maintain the constant-head level in the drywell at appropriate intervals. In no case shall the interval > 10 minutes.
6. Continue maintaining the constant-head level in the drywell until a stabilized flow rate has been achieved. Consider the flow rate stable when the incremental flow rate required to maintain the head does not vary by > 5% between increments. The intent of this step is to achieve a relatively steady-state flow condition between the minimum 1 hour time and a maximum time of 2 hours for this step. At the discretion of the qualified professional, the time for this step may be extended beyond the 2-hour maximum.
7. Upon completion of the constant-head period, discontinue flow and monitor the decrease in head level in the drywell at appropriate intervals for a 30-minute falling-head period.
8. Report test data in a format that includes time of day, flow meter readings, incremental flow rates, observed head levels and water depths in the drywell, and total flow volumes.

### ***Small-Scale Pilot Infiltration Test***

**(June 2013)**

### **Applicability**

Pilot infiltration tests (PITs) provide the advantage of in-situ field test procedures that approximate saturated conditions and allow inspection of soil stratigraphy beneath the infiltration test. Small-scale PITs are similar to large-scale PITs, discussed below, but have the advantage of reducing costs and test time. Small-scale PITs are appropriate for use for Best Management Practices (BMPs) with relatively low hydraulic loads.

### **Method**

1. Excavate the test pit to the estimated elevation at which the imported soil medium will lie on top of the underlying native soil. The side slopes may be laid back sufficiently to avoid caving and erosion during the test. However, the side slopes for the depth of ponding 6 to 12 inches during the test should be vertical.
2. The horizontal surface area of the bottom of the test pit should be 12 to 32 square feet (sf). The pit may be circular or rectangular, but accurately document the size and geometry of the test pit.
3. Install a vertical measuring rod adequate to measure the full ponded water depth and marked in 0.5-inch or centimeter increments in the center of the pit bottom.
4. Use a rigid pipe with a splash plate on the bottom to convey water to the pit and reduce sidewall erosion or excessive disturbance of the pond bottom. Excessive erosion and bottom disturbance will result in clogging of the infiltration receptor and yield lower than actual infiltration rates. Use a 3-inch-diameter pipe for pits on the smaller end of the recommended surface area and a 4-inch-diameter pipe for pits on the larger end of the recommended surface area.
5. Presoak period: add water to the pit so there is standing water for  $\geq 6$  hours. Maintain the presoak water level  $\geq 12$  inches above the bottom of the pit. In gravel soils – if standing water cannot be measured after 30 minutes and while maintaining a flow rate  $\geq 50$  gallons per minute, the presoak period can be terminated early.
6. At the end of the presoak period, add water to the pit at a rate that will maintain a 6- to 12-inch water level above the bottom of the pit over a full hour. The specific depth should be the same as the maximum designed ponding depth (usually 6 to 12 inches).
7. Every 15 minutes, record the cumulative volume and instantaneous flow rate in gallons per minute necessary to maintain the water level at the same point on the measuring rod.
8. After 1 hour, turn off the water and record the rate of infiltration in in/hr from the measuring rod data until the pit is empty.
9. A self-logging pressure sensor may also be used to determine water depth and drain-down.
10. At the conclusion of testing, overexcavate the pit to see if the test water is mounded on shallow restrictive layers or if it has continued to flow deep into the subsurface. The depth of excavation varies depending on soil type and depth to hydraulic restricting layer, and is determined by qualified professional.

### **Data Analysis**

- Calculate and record the saturated hydraulic conductivity (in/hr) in 30-minute or 1-hour increments until 1 hour after the flow has stabilized.
- Use statistical/trend analysis to obtain the hourly flow rate when the flow stabilizes. This would be the lowest hourly flow rate.
- Apply appropriate correction factors ([6.3.3 General Criteria for Infiltration BMPs](#)) to determine the site-specific design infiltration rate.

## ***Large-Scale Pilot Infiltration Test***

**(June 2013)**

### **Applicability**

Large-scale in-situ PITs is the preferred method for measuring the saturated hydraulic conductivity of the soil profile beneath large-scale permeable pavement installations where stormwater from adjacent impervious surfaces is directed to the pavement surface resulting in higher hydraulic loads.

### **Method**

1. Excavate the test pit to the estimated surface elevation of the proposed infiltration BMP. Lay back the slopes sufficiently to avoid caving and erosion during the test. Alternatively, consider shoring the sides of the test pit.
2. The horizontal surface area of the bottom of the test pit should be approximately 100 sf. Accurately document the size and geometry of the test pit.
3. Install a vertical measuring rod (minimum 5 feet) marked in 0.5-inch or centimeter increments in the center of the pit bottom.
4. Use a rigid 6-inch-diameter pipe with a splash plate on the bottom to convey water to the pit and reduce side wall erosion or excessive disturbance of the pond bottom.
5. Add water to the pit at a rate that will maintain a water level between 6 and 12 inches above the bottom of the pit.
6. Various meters can be used to measure the flow rate into the pit, including (but not limited to) rotameters and magnetic meters. The specific depth should be the same as the maximum designed ponding depth (usually 6 to 12 inches).
7. Every 15 to 30 minutes, record the cumulative volume and instantaneous flow rate in gallons per minute necessary to maintain the water level at the same point on the measuring rod.
8. Keep adding water to the pit until 1 hour after the flow rate into the pit has stabilized while maintaining the same pond water level. A stabilized flow rate should have a variation  $\leq 5\%$  in the total flow. The total of the presoak time plus the 1 hour after the flow rate has stabilized should be  $\geq 6$  hours.
9. After the flow rate has stabilized for  $\geq 1$  hour, turn off the water and record the rate of infiltration (in/hr or centimeters per hour) from the measuring rod data, until the pit is empty.

Consider running this falling-head phase of the test several times to estimate the dependency of infiltration rate with head.

10. At the conclusion of testing, overexcavate the pit to see if the test water is mounded on shallow restrictive layers or if it has continued to flow deep into the subsurface. The depth of excavation varies depending on soil type and depth to hydraulic restricting layer, and is determined by the qualified professional. Mounding is an indication that a mounding analysis is necessary.

### **Data Analysis**

- Calculate and record the saturated hydraulic conductivity (in/hr) in 30-minute or 1-hour increments until 1 hour after the flow has stabilized.
- Use statistical/trend analysis to obtain the hourly flow rate when the flow stabilizes. This would be the lowest hourly flow rate.
- Apply appropriate correction factors ([6.3.3 General Criteria for Infiltration BMPs](#)) to determine the site-specific design infiltration rate.

## **6.B.4 Recommended Laboratory Test Procedures**

This section discusses one standard laboratory test method for estimating saturated hydraulic conductivity:

- Soil grain size analysis method

### ***Applicability***

The soil grain size analysis method is a laboratory test-based method that estimates saturated hydraulic conductivity ( $K_{sat}$ ) using empirical relationships to grain size. It is used in place of in-situ testing where allowed. The soil grain size analysis method described herein was developed using data from soils that generally are unconsolidated by glacial advance. Application of this method to consolidated glacial soil, such as till, requires correction ([Massmann, 2008](#)), ([WSDOT, 2017b](#)).

### ***Method***

- Conduct an adequate number of grain size analyses to characterize each defined layer below the top of the final subgrade of the infiltration Best Management Practice (BMP) area to a depth of  $\geq 3$  times the maximum ponding depth, but  $\geq 3$  feet.
- Estimate the saturated hydraulic conductivity ( $K_{sat}$ ) of each applicable soil layer using the procedure specified in Section 2 of Massmann (2008), which is summarized below:

#### **Equation 6.16: Saturated Hydraulic Conductivity (Soil Grain Size Analysis Method)**

$$\log_{10} (K_{sat}) = -1.57 + 1.90 * d_{10} + 0.015 * d_{60} - 0.013 * d_{90} - 2.08 * f_{fines}$$

where:

$K_{sat}$  = saturated hydraulic conductivity (centimeters per second [cm/sec])



$d_{10}$  = grain size for which 10% of the sample is finer (millimeters [mm])

$d_{60}$  = grain size for which 60% of the sample is finer (mm)

$d_{90}$  = grain size for which 90% of the sample is finer (mm)

$f_{\text{fines}}$  = fraction of the soil (by weight) that passes a No. 200 sieve

- If the estimate using [Equation 6.16: Saturated Hydraulic Conductivity \(Soil Grain Size Analysis Method\)](#) is > than 0.01 cm/sec, recalculate  $K_{\text{sat}}$  using [Equation 6.17: Saturated Hydraulic Conductivity for Coarse-grained Soils \(Soil Grain Size Analysis Method\)](#) and use the greater of the two values:

### **Equation 6.17: Saturated Hydraulic Conductivity for Coarse-grained Soils (Soil Grain Size Analysis Method)**

$$\log_{10}(K_{\text{sat}}) = -1.32 + 1.225 * d_{10} - 0.376 * f_{\text{fines}}$$

where:

$K_{\text{sat}}$  = saturated hydraulic conductivity (cm/sec)

$d_{10}$  = grain size for which 10% of the sample is finer (mm)

$f_{\text{fines}}$  = fraction of the soil (by weight) that passes a No. 200 sieve

- If the estimate using [Equation 6.16: Saturated Hydraulic Conductivity \(Soil Grain Size Analysis Method\)](#) is < 0.01 cm/s, recalculate  $K_{\text{sat}}$  using [Equation 6.18: Saturated Hydraulic Conductivity for Fine-grained Soils \(Soil Grain Size Analysis Method\)](#):

### **Equation 6.18: Saturated Hydraulic Conductivity for Fine-grained Soils (Soil Grain Size Analysis Method)**

$$\log_{10}(K_{\text{sat}}) = -2.89 + 7.57 * d_{10} - 0.527 * d_{60} + 0.030 * d_{90} + 0.142 * f_{\text{fines}}$$

where:

$K_{\text{sat}}$  = saturated hydraulic conductivity (cm/sec)

$d_{10}$  = grain size for which 10% of the sample is finer (mm)

$d_{60}$  = grain size for which 60% of the sample is finer (mm)

$d_{90}$  = grain size for which 90% of the sample is finer (mm)

$f_{\text{fines}}$  = fraction of the soil (by weight) that passes a No. 200 sieve

## **Data Analysis**

- If the licensed professional conducting the investigation determines that deeper layers will influence the rate of infiltration for the infiltration BMP area, soil layers at greater depths should be considered when assessing the site's hydraulic conductivity characteristics.
- Machinery or material stockpiles and associated compaction should not be allowed in infiltration areas. [Equation 6.16: Saturated Hydraulic Conductivity \(Soil Grain Size Analysis\)](#)

[Method](#)) through [Equation 6.18: Saturated Hydraulic Conductivity for Fine-grained Soils \(Soil Grain Size Analysis Method\)](#) assume minimal compaction consistent with the use of tracked (e.g., low to moderate ground pressure) excavation equipment. If the soil layer being characterized has been exposed to heavy compaction, the hydraulic conductivity for the layer could be approximately an order of magnitude less than what would be estimated based on grain size characteristics alone ([Pitt et al., 1995](#)), ([Massmann, 2008](#)). In such cases, compaction effects should be taken into account when estimating hydraulic conductivity unless mitigated as determined by a licensed professional. Methods for correcting  $K_{sat}$  for compaction effects are provided by ([Massmann, 2008](#)) and ([WSDOT, 2017b](#)).

- Use the layer with the lowest saturated hydraulic conductivity to determine the measured hydraulic conductivity.
- Apply appropriate correction factors ([6.3.3 General Criteria for Infiltration BMPs](#)) to determine the site-specific design infiltration rate.

# Chapter 7 - Construction Stormwater Pollution Prevention

## 7.1 Introduction

### 7.1.1 Objective

This chapter provides guidance on planning, design, and implementation of stormwater management practices at construction sites. Runoff from development project sites during the construction phase can contribute to sedimentation of streams and carry other contaminants sufficient to result in water quality violations in receiving waters. Controlling erosion and preventing sediment and other pollutants from leaving the project site during the construction phase is achievable through implementation and maintenance of selected Best Management Practices (BMPs) that are appropriate both to the site and to the season during which construction activities take place.

The objective of this chapter is to provide guidance for avoiding adverse stormwater impacts from construction activities on downstream resources and on-site stormwater facilities. Minimization of stormwater flows, prevention of soil erosion, capture of waterborne sediment that has been unavoidably released from exposed soils, and protection of water quality from on-site pollutant sources are all readily achievable when the proper BMPs are planned, installed, and properly maintained.

Initial discussions between the project proponents and their designer can identify approaches to accomplishing a high quality, cost-effective project without compromising environmental protection. Often new ways are found to stage, time, and phase parts of a project to economize in terms of a contractor's schedule and use of construction materials. This collaborative planning process can produce methods to minimize or eliminate vulnerability and unnecessary risk associated with some traditional construction practices and techniques.

The construction phase of a project is usually considered a temporary condition, which will be supplanted by the permanent improvements and facilities for the completed project. However, construction work may take place over an extended period of time, including several seasons of multiple years. All BMPs used during the course of construction should be of sufficient size, strength, and durability to readily outlast the longest possible construction schedule and the worst anticipated rainfall conditions. BMPs should also be maintained during the course of construction and replaced or restored if degradation or failure of the BMP occurs.

Linear projects, such as roadway construction and utility installations, are special cases of construction activities and present their own, unique set of stormwater protection challenges. Many of the BMPs can be adapted and modified to provide the controls needed to adequately address these projects. It may be advantageous to segment long, linear projects into a series of separate units that can apply all necessary controls pertinent to that particular unit in a timely manner.

The goal of a Construction Stormwater Pollution Prevention Plan (SWPPP) is to avoid immediate and long-term environmental loss and degradation typically caused by poorly managed construction

sites. Prompt implementation of a Construction SWPPP, designed in accordance with this chapter, can provide a number of benefits. These include minimizing construction delays, reducing resources spent on repairing erosion, improving the relationship between the contractor and the permitting authority, and limiting adverse effects on the environment.

Many of the BMPs contained in this chapter can be adapted and modified to provide the erosion and sediment controls needed for other activities such as mining.

## 7.1.2 Content and Organization of This Chapter

This chapter consists of three sections that address the key considerations and mechanics of preparing and implementing a Construction SWPPP.

- [7.1 Introduction](#) highlights the importance of construction stormwater management in preventing pollution of receiving waters. The section lists the 13 elements of pollution prevention to be considered for all projects. The 13 elements are fully detailed in [7.2.3 Step-by-Step Procedure](#). Erosion and sedimentation processes and impacts are also described.
- [7.2.3 Step-by-Step Procedure](#) presents a step-by-step method for developing a Construction SWPPP. It encourages examination of all possible conditions that could reasonably affect a particular project's stormwater control systems during the construction phase of the project. [Step 3: Construction SWPPP Development and Implementation](#) provides detailed descriptions of each of the 13 elements of construction stormwater pollution prevention. [7.2.4 Checklists for Construction SWPPPs](#) provides a Construction SWPPP checklist.
- [7.3 Standards and Specifications for Best Management Practices](#) contains BMPs for construction stormwater control and site management. [7.3.2 Source Control BMPs](#) contains BMPs for source control. [7.3.3 Runoff Conveyance and Treatment BMPs](#) addresses runoff, conveyance, and treatment BMPs. Various combinations of these BMPs should be used in the Construction SWPPP to satisfy each of the 13 elements of construction stormwater management that apply to the project.

## 7.1.3 How to Use This Chapter

This chapter should be used in developing a Construction SWPPP, which is a required component of the Stormwater Site Plan (see [Chapter 3 - Preparation of Stormwater Site Plans](#)). See the introductory section ([7.1 Introduction](#)) for an overview of construction stormwater issues, particularly related to erosion and sedimentation. See [7.2 Planning](#) to determine the organization and content of the Construction SWPPP. This chapter includes lists of recommended BMPs to meet each element of construction stormwater pollution prevention. Based on these lists, the project proponent should refer to [7.3 Standards and Specifications for Best Management Practices](#) to determine which BMPs will be included in the Construction SWPPP and to design and document application of these BMPs to the project construction site.

## 7.1.4 Thirteen Elements of Construction Stormwater Pollution Prevention

The 13 elements in the following list must be considered in the development of the Construction SWPPP unless site conditions render the element unnecessary. If an element is considered

unnecessary, the Construction SWPPP must provide the justification. These 13 elements cover the general water quality protection strategies of limiting site impacts, preventing erosion and sedimentation, and managing activities and sources:

1. Mark Clearing Limits
2. Establish Construction Access
3. Control Flow Rates
4. Install Sediment Controls
5. Stabilize Soils
6. Protect Slopes
7. Protect Drain Inlets
8. Stabilize Channels And Outlets
9. Control Pollutants
10. Control Dewatering
11. Maintain BMPs
12. Manage the Project
13. Protect Low Impact Development BMPs (Infiltration BMPs)

A complete description of each element and the associated BMPs are given in [7.2.3 Step-by-Step Procedure](#), under [Step 3: Construction SWPPP Development and Implementation](#).

### **7.1.5 Erosion and Sedimentation Impacts**

Soil erosion and the resulting sedimentation produced by land development impacts the environment, damaging aquatic and recreational resources as well as affecting aesthetic qualities. Erosion and sedimentation ultimately affect everyone.

Common examples of impacts from soil erosion are the following:

- Reestablishing vegetation is difficult without applying nutrient-rich topsoils, soil amendments, and fertilizers. Silt from poorly stabilized areas fills culverts and storm drains, decreasing storage capacity, increasing flooding, and increasing maintenance frequencies and costs.
- Runoff treatment and flow control BMPs fill rapidly with sediment, decreasing storage capacity, increasing flooding, and increasing maintenance frequencies and costs.
- Sediment causes obstructions in streams and harbors, requiring dredging to restore navigability.
- Shallow areas in lakes form rapidly, resulting in growth of aquatic plants and reduced usability.
- Nutrient loading from phosphorus and nitrogen attached to soil particles and transported to

lakes and streams cause the water pH to change and algal blooms to occur, resulting in oxygen depletion, eutrophication, and fish kills.

- Water treatment for domestic uses becomes more difficult and costly.
- Turbid water replaces aesthetically pleasing, clear, clean water in streams and lakes.
- Eroded soil particles decrease the viability of macroinvertebrates and other organisms, impair the feeding ability of aquatic animals, clog gill passages of fish, and reduce photosynthesis.
- Sediment-clogged gravel diminishes fish spawning and can smother eggs or young fry.

Costs associated with these impacts can be obvious or subtle. Some are difficult to quantify, such as the loss of aesthetic values or recreational opportunities. Restoration and management of a single lake can cost millions of dollars. Reductions in spawning habitat, and subsequent reduction in salmon and trout production, cause economic losses to sports fisheries, traditional Native American fisheries, and the fishing industry. The maintenance costs of structures and harbors are readily quantifiable. Citizens pay repeatedly for these avoidable costs in their tax dollars.

Effective erosion and sediment control (ESC) BMPs on construction sites can greatly reduce undesirable environmental impacts and costs. Being aware of the erosion and sedimentation process is helpful in understanding the role of construction stormwater BMPs in controlling stormwater runoff.

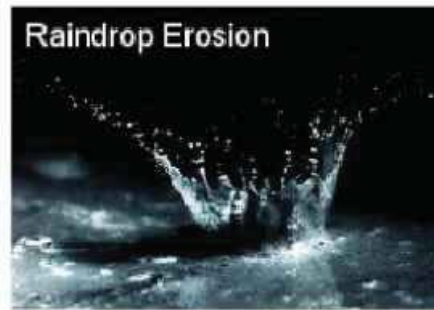
## **7.1.6 Erosion and Sedimentation Processes**

### ***Soil Erosion***

Soil erosion is defined as the removal of soil from its original location by the action of water, ice, gravity, or wind. In construction activities, soil erosion is largely caused by the force of falling and flowing water. Erosion by water includes the following processes:

- Raindrop Erosion: The direct impact of falling drops of rain on soil dislodges soil particles so that they can then be easily transported by runoff (see [Figure 7.1: Types of Erosion](#)).
- Sheet Erosion: The removal of a layer of exposed soil by the action of raindrop splash and runoff, as water moves in broad sheets over the land and is not confined in small depressions (see [Figure 7.1: Types of Erosion](#)).
- Rill and Gully Erosion: As runoff concentrates in rivulets, it cuts grooves called rills into the soil surface. If the flow of water is sufficient, rills may develop into larger gullies (see [Figure 7.1: Types of Erosion](#)).
- Stream and Channel Erosion: Increased volume and velocity of runoff in an unprotected, confined channel may cause stream meander instability and scouring of significant portions of the stream or channel banks and bottom (see [Figure 7.1: Types of Erosion](#)).
- Wind Erosion: Soil erosion by wind creates a water quality problem when dust is blown into water. Dust control on paved streets, if not conducted properly, can also create water quality problems.

**Figure 7.1: Types of Erosion**



## Types of Erosion

Revised June 2016

Please see <http://www.ecy.wa.gov/copyright.html> for copyright notice including permissions, limitation of liability, and disclaimer.

## **Sedimentation**

Sedimentation is defined as the gravity-induced settling of soil particles transported by water. The process is accelerated in slower moving, quiescent stretches of natural water bodies or in runoff treatment BMPs such as sediment ponds and wetponds.

Sedimentation occurs when the velocity of water in which soil particles are suspended is slowed for a sufficient time to allow particles to settle. The settling rate is dependent on the soil particle size. Heavier particles, such as sand and gravel, can settle more rapidly than fine particles such as clay and silt. Sedimentation of clay soil particles is reduced due to clay's relatively low density and electro-charged surfaces, which discourage aggregation. The presence of suspended clay particles in stormwater runoff can result in highly turbid water, which is very difficult to clarify using standard sediment control BMPs. Turbidity, an indirect measure of soil particles in water, is one of the primary water quality standards in Washington State law ([Chapter 173-201A WAC](#)). Turbidity is increased when erosion carries soil particles into receiving waters. Treating stormwater to reduce turbidity can be an expensive, difficult process with limited effectiveness. Any actions or prevention measures that reduce the volume of water needing treatment for turbidity are beneficial.

### **7.1.7 Factors Influencing Erosion Potential**

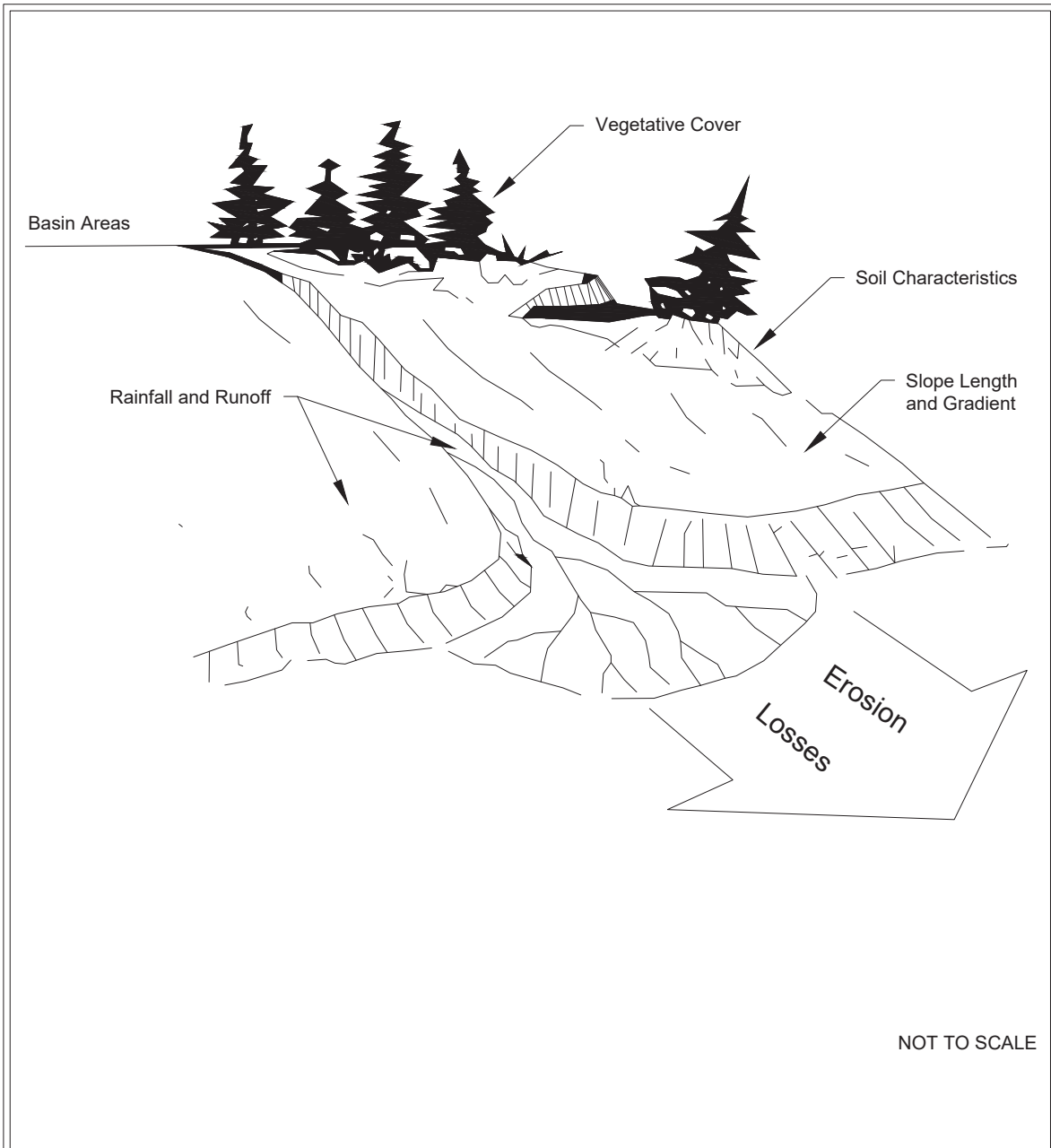
The erosion potential of soils can be readily determined using various models such as the Flaxman Method or the Revised Universal Soil Loss Equation (RUSLE).

The soil erosion potential of an area, including a construction site, is determined by four interrelated factors (see [Figure 7.2: Factors Influencing Erosion Potential](#)):

- Soil characteristics
- Vegetative cover
- Topography
- Climate



**Figure 7.2: Factors Influencing Erosion Potential**



## Factors Influencing Erosion Potential

Revised June 2016

Please see <http://www.ecy.wa.gov/copyright.html> for copyright notice including permissions, limitation of liability, and disclaimer.

Collection, analysis, and use of detailed information specific to the construction site for each of these four factors can provide the basis for an effective construction stormwater management system.

The first three factors (soil characteristics, vegetative cover, and topography) are constant with respect to time until altered intentionally by construction. The designer, developer, and construction contractor should have a working knowledge about and control over these factors to provide high-quality stormwater results.

The fourth factor (climate) is predictable by season, historical record, and probability of occurrence. While predicting a rainfall event is not possible, many of the impacts of construction stormwater runoff can be minimized or avoided by planning appropriate seasonal construction activity and using properly designed BMPs.

## **Soil Characteristics**

The vulnerability of soil to erosion is determined by soil characteristics: particle size, organic content, soil structure, and soil permeability.

**Particle Size:** Soils that contain high proportions of silt and very fine sand are generally the most erodible and are easily detached and carried away. The erodibility of soil decreases as the percentage of clay or organic matter increases; clay acts as a binder and tends to limit erodibility. Most soils with a high clay content are relatively resistant to detachment by rainfall and runoff. Once eroded, however, clays are easily suspended and settle out very slowly.

**Organic Content:** Organic matter creates a favorable soil structure, improving its stability and permeability. This increases infiltration capacity, delays the start of erosion, and reduces the amount of runoff.

The addition of organic matter increases infiltration rates (and, therefore, reduces surface flows and erodibility), water retention, pollution control, and pore space for oxygen.

**Soil Structure:** Organic matter, particle size, and gradation affect soil structure, which is the arrangement, orientation, and organization of particles. When the soil system is protected from compaction, the natural decomposition of plant debris on the surface maintains a healthy soil food web. The soil food web in turn maintains the porosity both on and below the surface.

**Soil Permeability:** Soil permeability refers to the ease with which water passes through a given soil. Well-drained and well-graded gravel and gravel mixtures with little or no silt are the least erodible soils. Their high-permeability and high-infiltration capacity helps prevent or delay runoff.

## **Vegetative Cover**

Vegetative cover plays an extremely important role in controlling erosion by:

- Shielding the soil surface from the impact of falling rain;
- Slowing the velocity of runoff, thereby permitting greater infiltration;
- Maintaining the soil's capacity to absorb water through root zone uptake and evapotranspiration; and
- Holding soil particles in place.

Erosion can be significantly reduced by limiting the removal of existing vegetation and by decreasing duration of soil exposure to rainfall events. Give special consideration to the preservation of existing vegetative cover on areas with a high potential for erosion such as erodible soils, steep slopes, drainage systems, and the banks of streams. When it is necessary to remove vegetation, such as for noxious weed eradication, the area should be revegetated at the earliest possible window for successful seeding.

## **Topography**

The size, shape, and slope of a construction site influence the amount and rate of stormwater runoff. Each site's unique dimensions and characteristics provide both opportunities for and limitations on the use of specific control measures to protect vulnerable areas from high runoff amounts and rates. Slope length, steepness, and surface texture are key elements in determining the volume and velocity of runoff. As slope length and/or steepness increase the rate of runoff and the potential for erosion increases. Slope orientation is also a factor in determining erosion potential. For example, a slope that faces south and contains droughty soils may provide such poor growing conditions that vegetative cover will be difficult to reestablish.

## **Climate**

Seasonal temperatures and the frequency, intensity, and duration of rainfall are fundamental factors in determining amounts of runoff. As the volume and the velocity of runoff increase, the likelihood of erosion increases. Where storms are frequent, intense, or of long duration, erosion risks are high. Seasonal changes in temperature, as well as variations in rainfall, help to define the period of the year when there is a high erosion risk. When precipitation falls as snow, no erosion occurs. In the spring, melting snow adds to the runoff, and erosion potential will be higher. If the ground is still partially frozen, infiltration capacity is reduced. In fall, winter, and spring, eastern Washington is characterized by storms that are mild and long lasting. The fall and early winter events may saturate the soil profile and fill stormwater detention ponds, increasing the amount of runoff leaving the construction site. Shorter term, more intense storms occur in the summer. These storms can cause problems if adequate BMPs have not been installed on-site.

# **7.2 Planning**

## **7.2.1 Introduction**

This section provides an overview of the important components of, and the process for, developing and implementing a Construction Stormwater Pollution Prevention Plan (SWPPP).

- [7.2.2 General SWPPP Guidelines](#) contains general guidelines with which site planners should become familiar. It describes criteria for plan format and content and ideas for improved plan effectiveness.
- [7.2.3 Step-by-Step Procedure](#) outlines and describes a recommended step-by-step procedure for developing a Construction SWPPP from data collection to finished product. This procedure is written in general terms to be applicable to all types of projects.
- [7.2.4 Checklists for Construction SWPPPs](#) includes a checklist for developing a Construction SWPPP.

- Design standards and specifications for Best Management Practices (BMPs) referred to in this section are found in [7.3 Standards and Specifications for Best Management Practices](#).

**Note:** The Construction SWPPP may be a subset of the Stormwater Site Plan or construction plan set (see [Chapter 3 - Preparation of Stormwater Site Plans](#)).

## 7.2.2 General SWPPP Guidelines

### *What Is a Construction SWPPP?*

The Construction SWPPP is a document that describes the potential for pollution problems on a construction project. The Construction SWPPP includes a narrative, drawings and details that explains and illustrates the measures to be taken on the construction site to control those problems. The local jurisdiction may allow small construction projects to prepare a simpler Construction SWPPP, consisting of a checklist and drawings. Designers should check with the local permitting authority about local requirements for Construction SWPPPs.

The Construction SWPPP must be located on the construction site or within reasonable access to the site for construction and inspection personnel.

As site work progresses, the plan must be modified to reflect changing site conditions, subject to the rules for plan modification by the jurisdiction.

The owner or lessee of the land being developed has the responsibility for Construction SWPPP preparation and submission to local authorities. The owner or lessee may designate someone (i.e., a designer, architect, contractor, etc.) to prepare the Construction SWPPP, but he/she retains the ultimate responsibility.

### *What Is an Adequate SWPPP?*

The Construction SWPPP must contain sufficient information to satisfy the plan approval authority of the local jurisdiction that the problems of pollution have been adequately addressed for the proposed project. An adequate Construction SWPPP includes a narrative and drawings. The narrative is a written statement to explain and justify the pollution prevention decisions made for a particular project. The narrative contains concise information about existing site conditions, construction schedules, and other pertinent items that are not contained on the drawings. The drawings and notes describe where and when the various BMPs should be installed, the performance the BMPs are expected to achieve, and actions to be taken if the performance goals are not achieved. If the construction schedule or other site-specific information is not available or unknown during initial SWPPP preparation, the information can be added to the SWPPP at a later date.

On construction sites that discharge to surface water, the primary concern in the preparation of the Construction SWPPP is compliance with Washington State water quality standards. Each of the 13 elements in [7.2.3 Step-by-Step Procedure](#) must be included in the Construction SWPPP unless an element is determined not to be applicable to the project and the exemption is justified in the narrative. The step-by-step procedure outlined in [7.2.3 Step-by-Step Procedure](#) is recommended for the development of the Construction SWPPPs. The checklists in [7.2.4 Checklists for Construction SWPPPs](#) may be helpful in preparing and reviewing the Construction SWPPP.

On construction sites that infiltrate all stormwater runoff, the primary concern in the preparation of the Construction SWPPP is the protection of the infiltration BMPs from fine sediments during the

construction phase and the protection of ground water from other pollutants. Several of the other elements are very important at these sites as well, such as marking the clearing limits, establishing the construction access, and managing the project.

As required by [Chapter 173-240 WAC](#), plans and specifications that involve “structures, equipment, or processes required to collect, carry away, treat, reclaim or dispose of industrial wastewater,” including contaminated stormwater, must be prepared under the supervision of a licensed engineer in the state of Washington. However, aspects of the SWPPP that do not directly pertain to BMPs that collect, carry away, treat, reclaim, or dispose of stormwater associated with construction activity (e.g., mulching, nets, blankets, or seeding) do not need to be prepared under the supervision of a licensed engineer in the state of Washington.

## ***BMP Standards and Specifications***

[7.3 Standards and Specifications for Best Management Practices](#) contains standards and specifications for the BMPs referenced throughout this chapter. Wherever any of these BMPs are to be used on a site, the specific title and number of the BMP should be clearly referenced in the narrative and marked on the drawings.

The standards and specifications in [7.3 Standards and Specifications for Best Management Practices](#) are not intended to limit any innovative or creative effort to effectively control erosion and sedimentation. In those instances where appropriate BMPs are not in this chapter, experimental management practices can be considered. Minor modifications to standard practices may also be used. However, such practices must be approved by the plan approval authority of the local jurisdiction before they may be used. All experimental management practices and modified standard practices are required to achieve the same or better performance than the BMPs listed in [7.3 Standards and Specifications for Best Management Practices](#).

## ***General Principles***

In addition to the 13 elements of a Construction SWPPP, the following general principles should be applied to the development of the Construction SWPPP:

- The duff layer, native topsoil, and natural vegetation should be retained in an undisturbed state to the maximum extent practicable.
- Prevent pollutant release. Select source control BMPs as a first line of defense. Prevent erosion rather than treat turbid runoff.
- Select BMPs depending on site characteristics (topography, drainage, soil type, ground cover, and critical areas) and the construction plan.
- Divert runoff away from exposed areas wherever possible. Keep clean water clean.
- Limit the extent of clearing operations and phase construction operations.
- Before seeding or planting permanent vegetation on an area where the topsoil has been stripped or compacted, the area should be reconditioned using the original topsoil and/or soil amendments such as compost to restore soil quality and promote successful revegetation.
- Incorporate natural drainage features whenever possible, using adequate buffers and protecting areas where flow enters the drainage system.

- Minimize slope length and steepness.
- Reduce runoff velocities to prevent channel erosion.
- Minimize the tracking of sediment off-site.
- Select appropriate BMPs for the control of pollutants other than sediment. Select source control BMPs as a first line of defense.
- Be realistic about the limitations of controls that you specify and the operation and maintenance of those controls. Anticipate what can go wrong, how you can prevent it from happening, and what will need to be done to fix it.

### 7.2.3 Step-by-Step Procedure

There are three basic steps in producing a Construction SWPPP:

- [Step 1: Data Collection](#)
- [Step 2: Data Analysis](#)
- [Step 3: Construction SWPPP Development and Implementation](#)

Steps 1 and 2 are intended for projects that are disturbing  $\geq 1$  acre. The local permitting authority may allow single-family home construction projects to prepare a simpler Construction SWPPP, consisting of a checklist and drawings.

#### **Step 1: Data Collection**

Evaluate existing site conditions and gather information that will help develop the most effective Construction SWPPP. The information gathered should be explained in the narrative and shown on the drawings.

- **Topography:** Prepare a topographic drawing of the site to show the existing contour elevations at intervals of 1 to 5 feet depending on the slope of the terrain.
- **Drainage:** Locate and clearly mark existing drainage swales and patterns on the drawing, including existing storm drain pipe systems.
- **Soils:** Identify and label soil type(s) and erodibility (low, medium, high, or an index value from the Natural Resources Conservation Services [NRCS] manual) on the drawing. Soils information can be obtained from a soil survey if one has been published for the county. If a soil survey is not available, a request can be made to a district NRCS office.

Soil permeability, percent organic matter, and effective depth should be expressed in average or nominal terms for the subject site or project. This information is frequently available in published literature, such as NRCS soil surveys. If it is not, the soils should be characterized by a licensed professional.

- **Ground cover:** Label existing vegetation on the drawing. Such features as tree clusters, grassy areas, and unique or sensitive vegetation should be shown. Unique vegetation may include existing trees above a given diameter. Local requirements regarding tree preservation

should be investigated. In addition, existing denuded or exposed soil areas should be indicated.

- **Critical areas:** Delineate critical areas adjacent to or within the site on the drawing. Such features as steep slopes, streams, floodplains, lakes, wetlands, sole source aquifers, and geologic hazard areas, etc., should be shown. Delineate setbacks and buffer limits for these features on the drawings. The local jurisdiction may have the critical areas largely established by local ordinance and the drawing should reflect those in addition to features identified by site inspection. Other related jurisdictional boundaries such as Shorelines Management and the Federal Emergency Management Agency (FEMA) base floodplain should also be shown on the drawings.
- **Adjacent areas:** Identify existing buildings, roads, and facilities adjacent to or within the project site on the drawings. Identify existing and proposed utility locations, construction clearing limits and erosion and sediment control (ESC) BMPs on the drawings.
- **Existing encumbrances:** Identify wells, existing and abandoned septic drain field, utilities, and site constraints.
- **Precipitation records:** See [Chapter 4 - Hydrologic Analysis and Design](#) to determine the required rainfall records and the method of analysis for design of BMPs.

## **Step 2: Data Analysis**

Consider the data collected in Step 1 to visualize potential problems and limitations of the site. Determine those areas that have critical erosion hazards. Some important factors to consider in data analysis are discussed in the following text.

- **Topography:** The primary topographic considerations are slope steepness and slope length. Because of the effect of runoff, the longer and steeper the slope, the greater the erosion potential. Erosion potential should be determined by a licensed professional.
- **Drainage:** Natural drainage patterns that consist of overland flow, swales and depressions should be used to convey runoff through the site to avoid constructing an artificial drainage system. Constructed ditches and drainage channels will become part of the erosion problem if they are not properly stabilized. Care should also be taken to ensure that increased runoff from the site will not erode or flood the existing natural drainage system. Possible sites for temporary stormwater retention and detention should be considered at this point.

Direct construction away from areas of saturated soil—areas where ground water may be encountered—and critical areas where drainage will concentrate. Preserve natural drainage patterns on the site.

- **Soils:** Develop the Construction SWPPP based on known soil characteristics. Infiltration sites should be properly protected from clay and silt, which will reduce infiltration capacities. Where necessary, evaluate soil properties such as surface and subsurface runoff characteristics, depth to impermeable layer, depth to seasonal ground water table, permeability, shrink-swell potential, texture, settleability, and erodibility.
- **Ground cover:** Ground cover is the most important factor in terms of preventing erosion. Existing vegetation that can be saved will prevent erosion better than constructed BMPs.

Trees and other vegetation protect the soil structure. If the existing vegetation cannot be saved, consider such practices as phasing construction, temporary seeding, and mulching. Phasing of construction involves stabilizing one part of the site before disturbing another. In this way, the entire site is not disturbed at once.

- **Critical areas:** Critical areas may include flood hazard areas, mine hazard areas, slide hazard areas, sole source aquifers, wetlands, streambanks, fish-bearing streams, and other water bodies. Any critical areas within or adjacent to the development should exert a strong influence on land development decisions. Critical areas and their buffers shall be delineated on the drawings and clearly marked in the field. Only unavoidable work should take place within critical areas and their buffers. Such unavoidable work will require special BMPs, permit restrictions, and mitigation plans.
- **Adjacent areas:** An analysis of adjacent properties should focus on areas upslope and downslope from the construction project. Water bodies that will receive direct runoff from the site are a major concern. The types, values, and sensitivities of and risks to downstream resources, such as private property, stormwater BMPs, public infrastructure, or aquatic systems, should be evaluated. ESC BMPs should be selected accordingly.
- **Precipitation records:** See [Chapter 4 - Hydrologic Analysis and Design](#) to determine the required rainfall records and the method of analysis for design of BMPs.
- **Timing of the project:** An important consideration in selecting BMPs is the timing and duration of the project. Projects that will proceed during the wet season and projects that will last through several seasons must take all necessary precautions to remain in compliance with the water quality standards.

### ***Step 3: Construction SWPPP Development and Implementation***

After collecting and analyzing the data to determine the site limitations, the project proponent can then develop a Construction SWPPP. Each of the 13 elements must be considered and included in the Construction SWPPP unless site conditions render the element unnecessary and the exemption from that element is clearly justified in the narrative of the SWPPP; the project proponent is granted flexibility in selecting appropriate BMPs to implement each element. Applicability for each element is divided into requirements for the Construction Stormwater General Permit (CSWGP) and the Phase II Municipal Stormwater National Pollutant Discharge Elimination System Permit for eastern Washington (Municipal Stormwater Permit) and additional guidance.

#### **Element #1: Preserve Vegetation/Mark Clearing Limits**

##### ***Construction Stormwater General Permit and Municipal Stormwater Permit Requirements***

- Prior to beginning land-disturbing activities, including clearing and grading, clearly mark all clearing limits, sensitive areas and their buffers, and trees that are to be preserved within the construction area. These shall be clearly marked, both in the field and on the plans, to prevent damage and off-site impacts.
- The duff layer, native top soil, and natural vegetation shall be retained in an undisturbed state to the maximum degree practicable.

#### ***Additional Guidance***



- Plastic, metal, or fabric fence may be used to mark the clearing limits. Note the difference between the practical use and proper installation of [BMP C233E: Silt Fence](#) and the proper use and installation of [BMP C103E: High-Visibility Fence](#).
- If it is not practical to retain the duff layer in place, then stockpile it on-site, cover it to prevent erosion, and replace it immediately when you finish disturbing the site.

### ***Suggested BMPs***

- [BMP C101E: Preserving Natural Vegetation](#)
- [BMP C102E: Buffer Zones](#)
- [BMP C103E: High-Visibility Fence](#)
- [BMP C233E: Silt Fence](#)

## **Element #2: Establish Construction Access**

### ***Construction Stormwater General Permit and Municipal Stormwater Permit Requirements***

- Limit construction vehicle access and exit to one route, if possible.
- Stabilize access points with a pad of quarry spalls, crushed rock, or other equivalent BMPs to minimize tracking sediment onto roads.
- Locate wheel wash or tire baths on-site, if the stabilized construction entrance is not effective in preventing tracking sediment onto roads.
- If sediment is tracked off-site, clean the affected roadway thoroughly at the end of each day, or more frequently as necessary (for example, during wet weather). Remove sediments from roads by shoveling, sweeping, or pick up and transport the sediment to a controlled sediment disposal area.
- Conduct street washing only after sediment is removed in accordance with the previous bullet.
- Control street wash wastewater by pumping back on-site or otherwise preventing it from discharging into systems tributary to waters of the state.

### ***Additional Guidance***

Minimize construction site access points along linear projects, such as roadways. Street washing may require local jurisdiction approval

### ***Suggested BMPs***

- [BMP C105E: Stabilized Construction Access](#)
- [BMP C106E: Wheel Wash](#)
- [BMP C107E: Construction Road/Parking Area Stabilization](#)

## **Element #3: Control Flow Rates**

## **Construction Stormwater General Permit and Municipal Stormwater Permit Requirements**

- Protect properties and receiving waters downstream of development sites from erosion and the associated discharge of turbid waters due to increases in the velocity and peak volumetric flow rate of stormwater runoff from the project site, as required by the local jurisdiction.
- Where necessary to comply with the previous bullet, construct stormwater retention or detention BMPs as one of the first steps in grading. Ensure that detention BMPs function properly before constructing site improvements (e.g., impervious surfaces).
- If permanent infiltration ponds are used for flow control during construction, these BMPs should be protected from siltation during the construction phase.

### **Additional Guidance**

- Conduct off-site analysis if changes in off-site flows could impair or alter conveyance systems, streambanks, bed sediment, or aquatic habitat. See [Chapter 3 - Preparation of Stormwater Site Plans](#) for off-site analysis guidelines.
- Even gently sloped areas need flow controls such as wattles or other energy dissipation/filtration structures. Place dissipation facilities closer together on steeper slopes. These methods prevent water from building higher velocities as it flows downstream within the construction site.
- Outlet structures designed for permanent detention ponds are not appropriate for use during construction without modification. If used during construction, install an outlet structure that will allow for long-term storage of runoff and enable sediment to settle. Verify that the pond is sized appropriately for this purpose. Restore ponds to their original design dimensions, remove sediment, and install a final outlet structure at completion of the project.
- Erosion has the potential to occur because of increases in the volume, velocity, and peak flow rate of stormwater runoff from the project site. The local permitting agency may require pond designs that provide additional or different stormwater flow control. These requirements may be necessary to address local conditions or to protect properties and receiving waters downstream.
- The jurisdiction may require pond designs that provide additional or different stormwater flow control. This may be necessary to address local conditions or to protect properties and receiving waters downstream from erosion due to increases in the volume, velocity, and peak flow rate of stormwater runoff from the project site.

### **Suggested BMPs**

- [BMP C203E: Water Bars](#)
- [BMP C207E: Check Dams](#)
- [BMP C209E: Outlet Protection](#)
- [BMP C235E: Wattles](#)
- [BMP C240E: Sediment Trap](#)

- [BMP C241E: Sediment Pond \(Temporary\)](#)
- See [Chapter 5 - Runoff Treatment BMP Design](#) and [Chapter 6 - Flow Control BMP Design](#) for detention, retention, and infiltration BMP design

#### **Element #4: Install Sediment Controls**

##### ***Construction Stormwater General Permit and Municipal Stormwater Permit Requirements***

- Construct sediment control BMPs (sediment ponds, traps, filters, etc.) as one of the first steps in grading. These BMPs shall be functional before other land-disturbing activities take place.
- Minimize sediment discharges from the site. The design, installation and maintenance of ESC BMPs must address factors such as the amount, frequency, intensity and duration of precipitation, the nature of resulting stormwater runoff, and soil characteristics, including the range of soil particle sizes expected to be present on the site.
- Direct stormwater runoff from disturbed areas through a sediment pond or other appropriate sediment removal BMP, before the runoff leaves a construction site or before discharge to an infiltration BMP. Runoff from fully stabilized areas may be discharged without a sediment removal BMP but must meet the flow control performance standard (see first bullet under [Element #3: Control Flow Rates](#)).
- Locate BMPs intended to trap sediment on site in a manner to avoid interference with the movement of juvenile salmonids attempting to enter off-channel areas or drainages.
- Provide and maintain natural buffers around receiving waters, direct stormwater to vegetated areas to increase sediment removal, and maximize stormwater infiltration, unless infeasible.
- Where feasible, design outlet structures that withdraw impounded stormwater from the surface to avoid discharging sediment that is still suspended lower in the water column.

##### ***Additional Guidance***

- Outlet structures that withdraw impounded stormwater from the surface to avoid discharging sediment that is still suspended lower in the water column are for the construction period only. If the pond using the construction outlet control is used for permanent stormwater controls, the appropriate outlet structure must be installed after the soil disturbance has ended.
- Seed and mulch earthen structures such as dams, dikes, and diversions according to the timing indicated in [Element #5: Stabilize Soils](#).
- Full stabilization includes concrete or asphalt paving; quarry spalls used as ditch lining; or the use of rolled erosion products, a bonded fiber matrix (BFM) product, or vegetative cover in a manner that will fully prevent soil erosion.
- The local jurisdiction may inspect and approve areas fully stabilized by means other than pavement or quarry spalls.
- If installing a floating pump structure, include a stopper to prevent the pump basket from hitting the bottom of the pond.

##### ***Suggested BMPs***

- [BMP C231E: Brush Barrier](#)
- [BMP C232E: Gravel Filter Berm](#)
- [BMP C233E: Silt Fence](#)
- [BMP C234E: Vegetated Strip](#)
- [BMP C235E: Wattles](#)
- [BMP C240E: Sediment Trap](#)
- [BMP C241E: Sediment Pond \(Temporary\)](#)
- [BMP C250E: Construction Stormwater Chemical Treatment](#)
- [BMP C251E: Construction Stormwater Filtration](#)

#### **Element #5: Stabilize Soils**

**Note:** The CSWGP refers to “the Permittee” throughout this section of the permit requirements. This language was removed herein to be consistent with the Municipal Stormwater Permit.

#### ***Construction Stormwater General Permit and Municipal Stormwater Permit Requirements***

- Stabilize exposed and unworked soils by application of effective BMPs that prevent erosion. Applicable BMPs include, but are not limited to temporary and permanent seeding, sodding, mulching, plastic covering, erosion control fabrics and matting, soil application of polyacrylamide (PAM), the early application of gravel base early on areas to be paved, and dust control.
- Control stormwater volume and velocity within the site to minimize soil erosion.
- Control stormwater discharges, including both peak flow rates and total stormwater volume, to minimize erosion at outlets and to minimize downstream channel and streambank erosion.
- To prevent erosion, soils must not remain exposed and unworked for more than the following time periods:

All of eastern Washington, except for the Central Basin (Climate Region 2, see [Figure 4.1: Average Annual Precipitation and Climate Regions](#)):

- During the regional dry season (July 1 through September 30): 10 days
- During the regional wet season (October 1 through June 30): 5 days

Central Basin (Climate Region 2, see [Figure 4.1: Average Annual Precipitation and Climate Regions](#)):

- During the regional dry season (July 1 through September 30): 30 days
- During the regional wet season (October 1 through June 30): 15 days
- Stabilize soils at the end of the shift before a holiday or weekend if needed based on the

weather forecast.

- Stabilize soil stockpiles from erosion, protect with sediment-trapping measures, and where possible, be located away from storm drain inlets, receiving waters, and drainage channels.
- Minimize the amount of soil exposed during construction activity.
- Minimize the disturbance of steep slopes.
- Minimize soil compaction and, unless infeasible, preserve topsoil.

### ***Additional Guidance***

- Soils must not remain exposed and unworked for more than the time periods set forth above to prevent erosion for linear projects such as right-of-way and easement clearing, road construction, pipeline and utility installation.
- Soil stabilization BMPs should be appropriate for the site conditions, time of year, estimated duration of use, and potential water quality impacts that stabilization agents may have on downstream waters or ground water.
- Ensure that gravel base used for stabilization is clean and does not contain fines or sediment.
- The greatest potential for soil erosion, particularly in the driest parts of eastern Washington, is during summer thunderstorms.

### ***Suggested BMPs***

- [BMP C120E: Temporary and Permanent Seeding](#)
- [BMP C121E: Mulching](#)
- [BMP C122E: Nets and Blankets](#)
- [BMP C123E: Plastic Covering](#)
- [BMP C124E: Sodding](#)
- [BMP C125E: Topsoiling/Composting](#)
- [BMP C126E: Polyacrylamide for Soil Erosion Protection](#)
- [BMP C130E: Surface Roughening](#)
- [BMP C131E: Gradient Terraces](#)
- [BMP C140E: Dust Control](#)

### **Element #6: Protect Slopes**

**Note:** The CSWGP refers to “the Permittee” throughout this section of the permit requirements. This language was removed here to be consistent with the Municipal Stormwater Permit.

### ***Construction Stormwater General Permit and Municipal Stormwater Permit Requirements***

- Design and construct cut-and-fill slopes in a manner to minimize erosion. Applicable practices include, but are not limited to, reducing continuous length of slope with terracing and diversions, reducing slope steepness, and roughening slope surfaces (for example, track walking).
- Divert off-site stormwater (run-on) or ground water away from slopes and disturbed areas with interceptor dikes, pipes, and/or swales. Off-site stormwater should be managed separately from stormwater generated on the site.
- At the top of slopes, collect drainage in pipe slope drains or protected channels to prevent erosion.
  - All of eastern Washington: Temporary pipe slope drains must handle the expected peak flow rate from a 6-month, 3-hour storm for the developed condition, referred to as the short-duration storm.
- Place excavated material on the uphill side of trenches, consistent with safety and space considerations.
- Place check dams at regular intervals within constructed channels that are cut down a slope.

#### **Additional Guidance**

- Consider soil type and its potential for erosion.
- Stabilize soils on slopes, as specified in [Element #5: Stabilize Soils](#).
- BMP combinations are the most effective method of protecting slopes with disturbed soils. For example, use both mulching and straw erosion control blankets in combination.

#### **Suggested BMPs**

- [BMP C120E: Temporary and Permanent Seeding](#)
- [BMP C121E: Mulching](#)
- [BMP C122E: Nets and Blankets](#)
- [BMP C123E: Plastic Covering](#)
- [BMP C124E: Sodding](#)
- [BMP C130E: Surface Roughening](#)
- [BMP C131E: Gradient Terraces](#)
- [BMP C200E: Interceptor Dike and Swale](#)
- [BMP C201E: Grass-Lined Channels](#)
- [BMP C203E: Water Bars](#)
- [BMP C204E: Pipe Slope Drains](#)

- [BMP C205E: Subsurface Drains](#)
- [BMP C206E: Level Spreader](#)
- [BMP C207E: Check Dams](#)
- [BMP C208E: Triangular Silt Dike \(TSD\)](#)

## **Element #7: Protect Drain Inlets**

### ***Construction Stormwater General Permit and Municipal Stormwater Permit Requirements***

- Protect all storm drain inlets made operable during construction so that stormwater runoff does not enter the conveyance system without first being filtered or treated to remove sediment.
- Clean or remove and replace inlet protection devices when sediment has filled one-third of the available storage (unless a different standard is specified by the product manufacturer).

### ***Additional Guidance***

- Where possible, protect all existing storm drain inlets so that stormwater runoff does not enter the conveyance system without first being filtered or treated to remove sediment.
- Keep all approach roads clean. Do not allow sediment and street washwater to enter storm drains without prior and adequate treatment unless treatment is provided before the storm drain discharges to waters of the state.
- Inlets should be inspected weekly at a minimum and daily during storm events.

### ***Suggested BMPs***

[BMP C220E: Inlet Protection](#)

## **Element #8: Stabilize Channels and Outlets**

### ***Construction Stormwater General Permit and Municipal Stormwater Permit Requirements***

- Design, construct, and stabilize all on-site conveyance channels to prevent erosion from the following expected peak flows:
  - All of eastern Washington: Channels must handle the expected peak flow rate from the 6-month, 3-hour storm for the developed condition, referred to as the short-duration storm.
- Provide stabilization, including armoring material, adequate to prevent erosion of outlets, adjacent streambanks, slopes, and downstream reaches at the outlets of all conveyance systems.

### ***Additional Guidance***

The best method for stabilizing channels is to completely line the channel with a blanket product first, then add check dams as necessary to function as an anchor and to slow the flow of water.

## ***Suggested BMPs***

- [BMP C202E: Riprap Channel Lining](#)
- [BMP C122E: Nets and Blankets](#)
- [BMP C207E: Check Dams](#)
- [BMP C209E: Outlet Protection](#)

## **Element #9: Control Pollutants**

### ***Construction Stormwater General Permit and Municipal Stormwater Permit Requirements***

- Design, install, implement and maintain effective pollution prevention measures to minimize the discharge of pollutants.
- Handle and dispose of all pollutants that occur on-site, including waste materials and demolition debris, in a manner that does not cause contamination of stormwater.
- Provide cover, containment, and protection from vandalism for all chemicals, liquid products, petroleum products, and materials that have the potential to pose a threat to human health or the environment. On-site fueling tanks must include secondary containment. Secondary containment means placing tanks or containers within an impervious structure capable of containing 110% of the volume contained in the largest tank within the containment structure. Double-walled tanks do not require additional secondary containment.
- Conduct maintenance, fueling, and repair of heavy equipment and vehicles using spill prevention measures and control measures. Clean contaminated surfaces immediately following any spill incident.
- Discharge wheel wash or tire bath wastewater to a separate on-site treatment system that prevents discharge to receiving water, such as closed-loop recirculation or upland land application, or to the sanitary sewer, with local sewer district approval.
- Apply fertilizers and pesticides in a manner and at application rates that will not result in loss of chemical to stormwater runoff. Follow manufacturers' label recommendations for application rates and procedures.
- Use BMPs to prevent contamination of stormwater runoff by pH-modifying sources. The sources for this contamination include, but are not limited to: bulk cement, cement kiln dust, fly ash, new concrete washing and curing waters, waste streams generated from concrete grinding and sawing, exposed aggregate processes, dewatering concrete vaults, recycled concrete stockpiles, and concrete pumping and mixer washout waters.
- Adjust the pH of stormwater if necessary to prevent violations of the water quality standards.
- Ensure that washout of concrete trucks is performed off-site or in designated concrete washout areas only. Do not wash out concrete trucks or concrete handling equipment onto the ground, or into storm drains, open ditches, streets, or streams. Do not dump excess concrete on-site, except in designated concrete washout areas. Concrete spillage or concrete discharge to surface waters of the state is prohibited.



- Obtain written approval from Ecology before using chemical treatment other than carbon dioxide or dry ice to adjust pH.

### ***Additional Guidance***

- Wheel wash or tire bath wastewater should not include wastewater from concrete washout areas.
- Do not use upland land applications for discharging wastewater from concrete washout areas
- Woody debris may be chopped and spread on-site.
- Conduct oil changes, hydraulic system drain down, solvent and degreasing cleaning operations, fuel tank drain down and removal, and other activities, which may result in discharge or spillage of pollutants to the ground or into stormwater runoff, using spill prevention measures such as drip pans.
- Clean contaminated surfaces immediately following any discharge or spill incident. Emergency repairs may be performed on-site using temporary plastic placed beneath and, if raining, over the vehicle.

### ***Suggested BMPs***

- [BMP C151E: Concrete Handling](#)
- [BMP C152E: Sawcutting and Surfacing Pollution Prevention](#)
- [BMP C153E: Material Delivery, Storage, and Containment](#)
- [BMP C154E: Concrete Washout Area](#)
- [BMP C250E: Construction Stormwater Chemical Treatment](#)
- [BMP C251E: Construction Stormwater Filtration](#)
- [BMP C252E: Treating and Disposing of High pH Water](#)
- See also [Chapter 8 - Source Control](#)

### **Element #10: Control Dewatering**

**Note:** The CSWGP refers to “the Permittee” throughout this section of the permit requirements. This language was removed herein to be consistent with the Municipal Stormwater Permit.

### ***Construction Stormwater General Permit and Municipal Stormwater Permit Requirements***

- Discharge foundation, vault, and trench dewatering water, which have characteristics similar to stormwater runoff at the site, into a controlled conveyance system before discharge to a sediment trap or sediment pond.
- Discharge clean, nonturbid dewatering water, such as well-point ground water, to systems tributary to, or directly into surface waters of the state, as specified in Element #8, provided the dewatering flow does not cause erosion or flooding of receiving waters or interfere with the

operation of the system. Do not route clean dewatering water through sediment ponds. Note that “surface waters of the state” may exist on a construction site as well as off-site; for example, a creek running through a site.

- Handle highly turbid or contaminated dewatering water separately from stormwater.
- Other treatment or disposal options may include the following:
  - Infiltration
  - Off-site transport in a vehicle, such as a vacuum flush truck, for legal disposal in a manner that does not pollute state waters
  - Ecology-approved on-site chemical treatment or other suitable treatment technologies
  - Sanitary or combined sewer discharge with local sewer district approval, if there is no other option
  - Use of a sedimentation bag with outfall to a ditch or swale for small volumes of localized dewatering

#### ***Additional Guidance***

- Channels shall be stabilized, as specified in [Element #8: Stabilize Channels and Outlets](#).
- Construction equipment operation, clamshell digging, concrete tremie pour, or work inside a cofferdam can create highly turbid or contaminated dewatering water.
- Discharging sediment-laden (muddy) water into surface waters of the state likely constitutes violation of water quality standards for turbidity. The easiest way to avoid discharging muddy water is through infiltration and preserving vegetation.

#### ***Suggested BMPs***

- [BMP C203E: Water Bars](#)
- [BMP C236E: Vegetative Filtration](#)

#### **Element #11: Maintain BMPs**

**Note:** The CSWGP refers to “the Permittee” throughout this section of the permit requirements. This language was removed herein to be consistent with the Municipal Stormwater Permit.

#### ***Construction Stormwater General Permit and Municipal Stormwater Permit Requirements***

- Maintain and repair all temporary and permanent ESC BMPs as needed to ensure continued performance of their intended function in accordance with BMP specifications.
- Remove all temporary ESC BMPs within 30 days after achieving final site stabilization or after the temporary BMPs are no longer needed.

#### ***Additional Guidance***

- Note: Some temporary ESC BMPs are biodegradable and designed to remain in place following construction such as compost socks. Compost socks can be split open to encourage biodegradation.
- Provide protection to all BMPs installed for the permanent control of stormwater from sediment and compaction. All BMPs that are to remain in place following completion of construction shall be examined and placed in full operating conditions. If sediment enters the BMPs during construction, it shall be removed and the facility shall be returned to the conditions specified in the construction documents.
- Remove or stabilize trapped sediment on-site. Permanently stabilize disturbed soil resulting from removal of BMPs or vegetation.

### ***Suggested BMPs***

- [BMP C150E: Materials on Hand](#)
- [BMP C160E: Certified Erosion and Sediment Control Lead](#)

## **Element #12: Manage the Project**

### ***Construction Stormwater General Permit and Municipal Stormwater Permit Requirements***

- Phase development projects to the maximum degree practicable and take into account seasonal work limits.
- Inspection and monitoring – Inspect, maintain, and repair all BMPs as needed to ensure continued performance of their intended function. Conduct site inspections and monitoring in accordance with the CSWGP or local plan approval authority.
- Maintaining an updated Construction SWPPP – Maintain, update, and implement the SWPPP in accordance with the CSWGP.

### ***Municipal Stormwater Permit Requirements***

Projects that disturb  $\geq 1$  acre must have site inspections conducted by a Certified Erosion and Sediment Control Lead (CESCL). On project sites  $< 1$  acre (not part of a larger common plan of development or sale) the inspections may be conducted by a person other than a CESCL. By the initiation of construction, the SWPPP must identify the CESCL or inspector, who shall be present on-site or on-call at all times.

### ***Additional Guidance***

The project manager must ensure that the project is built in such a way as to comply with all Construction SWPPP elements, as detailed in this section. Considerations for the project manager include, but are not limited to, the following:

- Construction phasing
- Seasonal work limitations
- Coordination with utilities and other contractors

- Inspection
- Monitoring
- Maintenance of an updated Construction SWPPP

### **Phasing of Construction**

Phase development projects where feasible in order to prevent soil erosion and, to the maximum extent practicable, and prevent transporting sediment from the site during construction. Revegetate exposed areas and maintain that vegetation as an integral part of the clearing activities for any phase.

Clearing and grading activities for developments shall be permitted only if conducted using an approved site development plan (e.g., subdivision approval) that establishes permitted areas of clearing, grading, cutting, and filling. Minimize removing trees and disturbing or compacting native soils when establishing permitted clearing and grading areas. Show on the site plans and the development site permitted clearing and grading areas and any other areas required to preserve critical or sensitive areas, buffers, native growth protection easements, or tree retention areas as may be required by local jurisdictions.

### **Seasonal Work Limitations**

The jurisdiction may impose a seasonal limitation on-site disturbance. This decision may be based on local weather conditions and/or other provided information including the site conditions, the extent and nature of the construction activity, and the proposed ESC BMPs.

The jurisdiction may take enforcement action—such as a notice of violation, administrative order, penalty, or stop-work order under either of the following circumstances:

- If, during the course of any construction activity or soil disturbance during the seasonal limitation period, sediment leaves the construction site causing a violation of the surface water quality standard
- If clearing and grading limits or ESC BMPs shown in the approved plan are not maintained

The following activities are exempt from the seasonal clearing and grading limitations:

- Routine maintenance and necessary repair of ESC BMPs.
- Routine maintenance of public facilities or existing utility structures that do not expose the soil or result in the removal of the vegetative cover to soil.
- Activities where there is 100% infiltration of stormwater runoff within the site in approved and installed ESC BMPs

### **Coordination with Utilities and Other Contractors**

When preparing the Construction SWPPP, the primary project proponent shall evaluate, with input from utilities and other contractors, the stormwater management requirements for the entire project, including the utilities.

### **Inspection**

All BMPs shall be inspected, maintained, and repaired as needed to ensure continued performance

of their intended function. Site inspections must be conducted by a person knowledgeable in the principles and practices of ESC. The person must have the skills to (1) assess the site conditions and construction activities that could impact the quality of stormwater, and (2) assess the effectiveness of ESC measures used to control the quality of stormwater discharges.

For construction sites  $\geq 1$  acre that discharge stormwater to surface waters of the state, a CESCL must be identified in the Construction SWPPP; this person shall be on-site or on-call at all times. Certification must be obtained through an approved training program that meets the ESC training standards established by Ecology. See [BMP C160E: Certified Erosion and Sediment Control Lead](#).

Appropriate BMPs or design changes shall be implemented as soon as possible, whenever inspection and/or monitoring reveals that the BMPs identified in the Construction SWPPP are inadequate, due to the actual discharge of /or potential to discharge a significant amount of any pollutant.

The CESCL or inspector (project sites < 1 acre) must have the skills to assess the following:

- Site conditions and construction activities that could impact the quality of stormwater
- Effectiveness of ESC BMPs used to control the quality of stormwater discharges

The CESCL or inspector must examine stormwater visually for the presence of suspended sediment, turbidity, discoloration, and oil sheen. The CESCL or inspector must evaluate the effectiveness of BMPs and determine whether it is necessary to install, maintain, or repair BMPs to improve the quality of stormwater discharges.

Based on the results of the inspection, the construction site operator must correct the problems identified by the following actions:

- Reviewing the SWPPP for compliance with the 13 Construction SWPPP elements and making appropriate revisions within 7 days of the inspection.
- Immediately beginning the process of fully implementing and maintaining appropriate source control and/or treatment BMPs as soon as possible, addressing the problems within 10 days of the inspection at the latest. If installation of necessary treatment BMPs is not feasible within 10 days, the construction site operator may request an extension within the initial 10-day response period.
- Documenting BMP implementation and maintenance in the site logbook (applies only to sites that have coverage under the CSWGP).

The CESCL or inspector must inspect all areas disturbed by construction activities, all BMPs, and all stormwater discharge points at least once every calendar week and within 24 hours of any discharge from the site. (For purposes of this condition, individual discharge events that last more than 1 day do not require daily inspections. For example, if a stormwater pond discharges continuously over the course of a week, only one inspection is required that week.) The CESCL or inspector may reduce the inspection frequency for temporary stabilized, inactive sites to once every calendar month.

### **Maintaining an Updated Construction SWPPP**

Retain the Construction SWPPP on-site. If it is not possible to retain the Construction SWPPP on-site, it must be located within reasonable access to the site.

Modify the Construction SWPPP whenever there is a change in the design, construction, operation, or maintenance at the construction site that has, or could have, a significant effect on the discharge of pollutants to waters of the state.

The Construction SWPPP must be modified if, during inspections or investigations conducted by the owner/operator, or the applicable local or state regulatory authority, it is determined that the Construction SWPPP is ineffective in eliminating or significantly minimizing pollutants in stormwater discharges from the site. Modify the Construction SWPPP as necessary to include additional or modified BMPs designed to correct problems identified. Complete revisions to the Construction SWPPP within 7 days following the inspection.

### ***Suggested BMPs***

- [BMP C150E: Materials on Hand](#)
- [BMP C160E: Certified Erosion and Sediment Control Lead](#)
- [BMP C162E: Scheduling](#)

### **Element #13: Protect Low Impact Development BMPs (Infiltration BMPs)**

#### ***Construction Stormwater General Permit and Municipal Stormwater Permit Requirements***

- Protect all infiltration BMPs from sedimentation through installation and maintenance of ESC BMPs on portions of the site that drain into the infiltration BMPs. Restore the BMPs to their fully functioning condition if they accumulate sediment during construction. Restoring the BMP must include removal of sediment and any sediment-laden soils within an infiltration BMP, and replacing the removed soils with soils meeting the design specification.
- Prevent compacting infiltration BMPs by excluding construction equipment and foot traffic. Protect completed lawn and landscaped areas from compaction due to construction equipment.
- Control erosion and avoid introducing sediment from surrounding land uses onto permeable pavements. Do not allow muddy construction equipment on the base material or pavement. Do not allow sediment-laden runoff onto permeable pavements.
- Permeable pavements fouled with sediments or no longer passing an initial infiltration test must be cleaned using procedures from the local stormwater manual or the manufacturer's procedures.
- Keep all heavy equipment off existing soils under infiltration BMPs that have been excavated to final grade to retain the infiltration rate of the soils.

### ***Suggested BMPs***

- [BMP C102E: Buffer Zones](#)
- [BMP C103E: High-Visibility Fence](#)
- [BMP C200E: Interceptor Dike and Swale](#)
- [BMP C201E: Grass-Lined Channels](#)

- [BMP C207E: Check Dams](#)
- [BMP C208E: Triangular Silt Dike \(TSD\)](#)
- [BMP C231E: Brush Barrier](#)
- [BMP C233E: Silt Fence](#)
- [BMP C234E: Vegetated Strip](#)

## **7.2.4 Checklists for Construction SWPPPs**

The Construction SWPPP consists of two parts:

- Construction SWPPP Narrative
- Erosion and Sediment Control Plans

The checklist in this section can be used to determine whether all the major items are included in the Construction SWPPP. Recommended standard notes that can be included in a Construction SWPPP can be found in [Appendix 7-A: Recommended Standard Notes for Construction SWPPP Drawings](#).

### ***Construction Stormwater Pollution Prevention Plan Checklist***

#### **Section I – Construction SWPPP Narrative**

##### ***1. Construction Stormwater Pollution Prevention Elements***

- a. Describe how each of the Construction Stormwater Pollution Prevention Elements has been addressed through the Construction SWPPP.
- b. Identify the type and location of BMPs used to satisfy the required element.
- c. Provide written justification identifying the reason an element is not applicable to the proposal.

##### ***Thirteen Required Elements – Construction Stormwater Pollution Prevention Plan***

1. Mark Clearing Limits
2. Establish Construction Access
3. Control Flow Rates
4. Install Sediment Controls
5. Stabilize Soils
6. Protect Slopes
7. Protect Drain Inlets
8. Stabilize Channels and Outlets

9. Control Pollutants
10. Control De-Watering
11. Maintain BMPs
12. Manage the Project
13. Protect Low Impact Development BMPs (Infiltration BMPs)

## **2. Project Description**

- a. Total project area
- b. Total proposed impervious area
- c. Total proposed area to be disturbed, including off-site borrow and fill areas
- d. Total volumes of proposed cut and fill

## **3. Existing Site Conditions**

- a. Description of the existing topography
- b. Description of the existing vegetation
- c. Description of the existing drainage

## **4. Adjacent Areas**

- I. Description of adjacent areas that may be affected by site disturbance or drain to project site.
  - a. Streams
  - b. Lakes
  - c. Wetlands
  - d. Residential Areas
  - e. Roads
  - f. Other
- II. Description of the downstream drainage path leading from the site to the receiving body of water. (Minimum distance of 400 yards.)

## **5. Critical Areas**

- a. Description of critical areas that are on or adjacent to the site.
- b. Description of special requirements for working in or near critical areas.

## **6. Soils**



I. Description of on-site soils

- a. Soil name(s)
- b. Soil mapping unit
- c. Erodibility
- d. Settleability
- e. Permeability
- f. Depth
- g. Texture
- h. Soil Structure

**7. Erosion Problem Areas**

- a. Description of potential erosion problems on site.

**8. Construction Phasing**

- a. Construction sequence
- b. Construction phasing (if proposed)

**9. Construction Schedule**

- I. Provide a proposed construction schedule.
- II. Wet Season Construction Activities
  - a. Proposed wet season construction activities.
  - b. Proposed wet season construction restraints for environmentally sensitive/critical areas.

**10. Financial/Ownership Responsibilities**

- a. Identify the property owner responsible for the initiation of bonds and/or other financial securities.
- b. Describe bonds and/or other evidence of financial responsibility for liability associated with erosion and sedimentation impacts.

**11. Engineering Calculations**

- I. Provide Design Calculations.
  - a. Sediment Ponds/Traps
  - b. Diversions

- c. Waterways
- d. Runoff/stormwater detention calculations

## **Section II – Erosion and Sediment Control Plans**

### **1. General**

- a. Vicinity map
- b. City/county of \_\_\_\_\_ clearing and grading approval block
- c. Erosion and sediment control notes

### **2. Site Plan**

- a. Note legal description of subject property.
- b. Show north arrow.
- c. Indicate boundaries of existing vegetation, e.g., tree lines and pasture areas.
- d. Identify and label areas of potential erosion problems.
- e. Identify any on-site or adjacent critical areas and associated buffers.
- f. Identify Federal Emergency Management Agency (FEMA) base flood boundaries and shoreline management boundaries (if applicable).
- g. Show existing and proposed contours.
- h. Indicate drainage basins and direction of flow for individual contributing areas.
- i. Label final grade contours and identify developed condition drainage basins.
- j. Delineate areas that are to be cleared and graded.
- k. Show all cut-and-fill slopes, indicating top and bottom of slope catch lines.

### **3. Conveyance Systems**

- a. Designate locations for swales, interceptor trenches, or ditches.
- b. Show all temporary and permanent drainage pipes, ditches, or cut-off trenches required for erosion and sediment control.
- c. Provide minimum slope and cover for all temporary pipes or call out pipe inverts.
- d. Show grades, dimensions, and direction of flow in all ditches, swales, culverts, and pipes.
- e. Provide details for bypassing off-site runoff around disturbed areas.
- f. Indicate locations and outlets of any dewatering systems.

### **4. Location of Detention BMPs**

- a. Identify location of detention BMPs.

#### **5. Erosion and Sediment Control BMPs**

- a. Show the locations of sediment trap(s), pond(s), pipes and structures.
- b. Dimension pond berm widths and inside and outside pond slopes.
- c. Indicate the trap/pond storage required and the depth, length, and width dimensions.
- d. Provide typical section views through pond and outlet structure.
- e. Provide typical details of gravel cone and standpipe, and/or other filtering devices.
- f. Detail stabilization techniques for outlet/inlet.
- g. Detail control/restrictor device location and details.
- h. Specify mulch and/or recommended cover of berms and slopes.
  - i. Provide rock specifications and detail for rock check dam(s), if applicable.
  - j. Specify spacing for rock check dams as required.
- k. Provide front and side sections of typical rock check dams.
  - l. Indicate the locations and provide details and specifications for silt fabric.
- m. Locate the construction entrance and provide a detail.

#### **6. Detailed Drawings**

- a. Any structural practices used that are not referenced in the Washington State Department of Ecology's *Stormwater Management Manual for Eastern Washington* should be explained and illustrated with detailed drawings.

#### **7. Other Pollutant BMPs**

- a. Indicate on the site plan the location of BMPs to be used for the control of pollutants other than sediment, e.g., concrete washwater.

#### **8. Monitoring Locations**

- a. Indicate on the site plan the water quality sampling locations to be used for monitoring water quality on the construction site, if applicable.
- b. Check for impaired water bodies and address discharges to 303(d) or Total Maximum Daily Load (TMDL) water bodies.

## 7.3 Standards and Specifications for Best Management Practices

### 7.3.1 Introduction

Best Management Practices (BMPs) are defined as schedules of activities, prohibitions of practices, maintenance procedures, and structural and/or managerial practices, that when used singly or in combination, prevent or reduce the release of pollutants to waters of Washington State. This section contains standards and specifications for temporary BMPs to be used as applicable during the construction phase of a project. Often using BMPs in combination is the best method to meet Construction Stormwater Pollution Prevention Plan (SWPPP) requirements.

None of the BMPs will work successfully during the construction project without inspection and maintenance. Regular inspections to identify problems with the operation of each BMP, and the timely repair of any problems, are essential to the continued operation of the BMPs.

- [7.3.2 Source Control BMPs](#) contains the standards and specifications for source control BMPs.
- [7.3.3 Runoff Conveyance and Treatment BMPs](#) contains the standards and specifications for runoff conveyance and treatment BMPs.

The standards for each individual BMP are divided into four sections:

- Purpose
- Conditions of Use
- Design and Installation Specifications
- Maintenance Standards

**Note:** “Conditions of Use” always refers to site conditions. As site conditions change, BMPs must be changed to remain in compliance.

**For more information:** Information on streambank stabilization is available in the *Integrated Streambank Protection Guidelines* ([WDFW, 2002](#)).

### 7.3.2 Source Control BMPs

#### BMP C101E: Preserving Natural Vegetation

##### *Purpose*

The purpose of preserving natural vegetation is to reduce erosion wherever practicable. Limiting site disturbance is the single most effective method for reducing erosion. For example, conifers can hold up to about 50% of all rain that falls during a storm. Up to 20% to 30% of this rain may never reach the ground but is taken up by the tree or evaporates. Another benefit is that the rain held in the tree can be released slowly to the ground after the storm.

## ***Conditions of Use***

Natural vegetation should be preserved on steep slopes, near perennial and intermittent receiving waters or swales, and on building sites in wooded areas.

- As required by the local jurisdiction.
- Phase construction to preserve natural vegetation on the project site for as long as possible during the construction period.

## ***Design and Installation Specifications***

Natural vegetation can be preserved in natural clumps or as individual trees, shrubs and vines.

The preservation of individual plants is more difficult because heavy equipment is generally used to remove unwanted vegetation. The points to remember when attempting to save individual plants are the following:

- Whether the plant is worth saving. Consider the location, species, size, age, vigor, and the work involved. Local jurisdictions may also have ordinances to save natural vegetation and trees.
- Fence or clearly mark areas around trees that are to be saved. It is preferable to keep ground disturbance away from the trees at least as far out as the dripline.

Plants need protection from three kinds of injuries:

- Construction equipment: This injury can be above or below the ground level. Damage results from scarring, cutting of roots, and compaction of the soil. Placing a fenced buffer zone around plants to be saved prior to construction can prevent construction equipment injuries.
- Grade changes: Changing the natural ground level will alter grades, which affects the plant's ability to obtain the necessary air, water, and minerals. Minor fills usually do not cause problems although sensitivity between species does vary and should be checked. Trees can tolerate fill of 6 inches or less. For shrubs and other plants, the fill should be less.

When there are major changes in grade, it may become necessary to supply air to the roots of plants. This can be done by placing a layer of gravel and a tile system over the roots before the fill is made. The tile system should be laid out on the original grade leading from a drywell around the tree trunk. The system should then be covered with small rocks to allow air to circulate over the root area.

- Lowering the natural ground level can seriously damage trees and shrubs. The highest percentage of the plant roots are in the upper 12 inches of the soil and cuts of only 2 to 3 inches can cause serious injury. To protect the roots, it may be necessary to terrace the immediate area around the plants to be saved. If roots are exposed, construction of retaining walls may be needed to keep the soil in place. Plants can also be preserved by leaving them on an undisturbed, gently sloping mound. To increase the chances for survival, it is best to limit grade changes and other soil disturbances to areas outside the dripline of the plant.
- Excavations: Protect trees and other plants when excavating for drain fields and power, water, and sewer lines. Where possible, the trenches should be routed around trees and large

shrubs. When this is not possible, it is best to tunnel under them. This can be done with hand tools or with power augers. If it is not possible to route the trench around plants to be saved, the following guidelines should be followed:

- Cut as few roots as possible. When you have to cut, cut clean. Paint cut root ends with a wood dressing like asphalt base paint if roots will be exposed for more than 24 hours.
- Backfill the trench as soon as possible.
- Tunnel beneath root systems as close to the center of the main trunk to preserve most of the important feeder roots.

Some problems that can be encountered are the following:

- In general, most trees native to eastern Washington do not readily adjust to major changes in environment and special care should be taken to protect these trees.
- The danger of windthrow increases where dense stands of coniferous trees have been thinned. Other species (unless they are on shallow, wet soils less than 20 inches deep) have a low windthrow hazard.
- Cottonwoods, maples, and willows have water-seeking roots. These can cause trouble in sewer lines and infiltration fields. On the other hand, they thrive in high moisture conditions that other trees would not.
- Thinning operations in pure or mixed stands of grand fir, Pacific silver fir, noble fir, Sitka spruce, western redcedar, western hemlock, Pacific dogwood, and red alder can cause serious disease problems. Disease can become established through damaged limbs, trunks, roots, and freshly cut stumps. Diseased and weakened trees are also susceptible to insect attack.

## ***Maintenance Standards***

- Inspect flagged and/or fenced areas regularly to make sure flagging or fencing has not been removed or damaged. If the flagging or fencing has been damaged or visibility reduced, it shall be repaired or replaced immediately and visibility restored.
- If tree roots have been exposed or injured, “prune” cleanly with an appropriate pruning saw or loppers directly above the damaged roots and recover with native soils. Treatment of sap flowing trees (e.g., fir, hemlock, pine, soft maples) is not advised as sap forms a natural healing barrier.

## **BMP C102E: Buffer Zones**

### ***Purpose***

Creation of an undisturbed area or strip of natural vegetation or an established suitable planting that will provide a living filter to reduce soil erosion and stormwater runoff velocities.

## **Conditions of Use**

- Natural buffer zones are used along streams, wetlands and other bodies of water that need protection from erosion and sedimentation. Contractors can use vegetative buffer zones to protect natural swales, and they can incorporate them into the natural landscaping of an area.
- Do not use critical-areas buffer zones as sediment treatment areas. These areas shall remain completely undisturbed. The jurisdiction may expand the buffer widths temporarily to allow the use of the expanded area for removal of sediment.

## **Design and Installation Specifications**

- Preserving natural vegetation or plantings in clumps, blocks, or strips is generally the easiest and most successful method.
- Leave all unstable steep slopes in natural vegetation.
- Mark clearing limits and keep all equipment and construction debris out of the natural areas and buffer zones. Steel construction fencing is the most effective method to protect sensitive areas and buffers. Alternatively, wire-backed silt fence on steel posts is marginally effective. Flagging alone is typically not effective.
- Keep all excavations outside the dripline of trees and shrubs.
- Do not push debris or extra soil into the buffer zone area because it will cause damage by burying and smothering vegetation.
- Vegetative buffer zones for streams, lakes or other receiving waters shall be established by the jurisdiction or other state or federal permits or approvals.

## **Maintenance Standards**

Inspect the area frequently to make sure flagging remains in place and the area remains undisturbed. Replace all damaged flagging immediately.

## **BMP C103E: High-Visibility Fence**

### **Purpose**

High-visibility fencing is intended to:

- Restrict clearing to approved limits;
- Prevent disturbance of sensitive areas, their buffers, and other areas required to be left undisturbed;
- Limit construction traffic to designated construction entrances, exits, or internal roads; and
- Protect areas where marking with survey tape may not provide adequate protection.

### **Conditions of Use**

To establish clearing limits, plastic, fabric, or metal fence may be used under certain conditions:

- At the boundary of sensitive areas, their buffers, and other areas required to be left uncleared
- As necessary to control vehicle access to and on the site

### ***Design and Installation Specifications***

- High-visibility plastic fence shall be composed of a high-density polyethylene (HDPE) material and shall be  $\geq 4$  feet in height. Posts for the fencing shall be steel or wood and placed every 6 feet on center (maximum) or as needed to ensure rigidity. The fencing shall be fastened to the post every 6 inches with a polyethylene tie. On long continuous lengths of fencing, a tension wire or rope shall be used as a top stringer to prevent sagging between posts. The fence color shall be high-visibility orange. The fence tensile strength shall be 360 pounds per foot (lb/ft) using the ASTM D4595 testing method.
- If appropriate, install fabric silt fence in accordance with BMP C233E (Silt Fence) to act as high-visibility fence. Silt fence shall be  $\geq 3$  feet high and must be highly visible to meet the requirements of this BMP.
- Metal fences shall be designed and installed according to the manufacturer's specifications.
- Metal fences shall be  $\geq 3$  feet high and must be highly visible.
- Fences shall not be wired or stapled to trees.

### ***Maintenance Standards***

If the fence has been damaged or visibility reduced, it shall be repaired or replaced immediately and visibility restored.

### ***BMP C105E: Stabilized Construction Access***

Stabilized construction entrances are established to reduce the amount of sediment transported onto paved roads by vehicles or equipment. This is done by constructing a stabilized pad of quarry spalls at entrances and exits for construction sites.

- Construction entrances shall be stabilized wherever traffic will be entering or leaving a construction site if paved roads or other paved areas are within 1,000 feet of the site.
- For residential subdivision construction sites, provide stabilized construction entrances for each residence, rather than only at the main subdivision entrance. Stabilized surfaces shall be of sufficient length/width to provide vehicle access/parking, based on lot size and configuration.
- On large commercial, highway, and road projects, the designer should include enough extra materials in the contract to allow for additional stabilized entrances not shown in the initial Construction Stormwater Pollution Prevention Plan (SWPPP). It is difficult to determine exactly where access to these projects will take place; additional materials will enable the contractor to install them where needed.



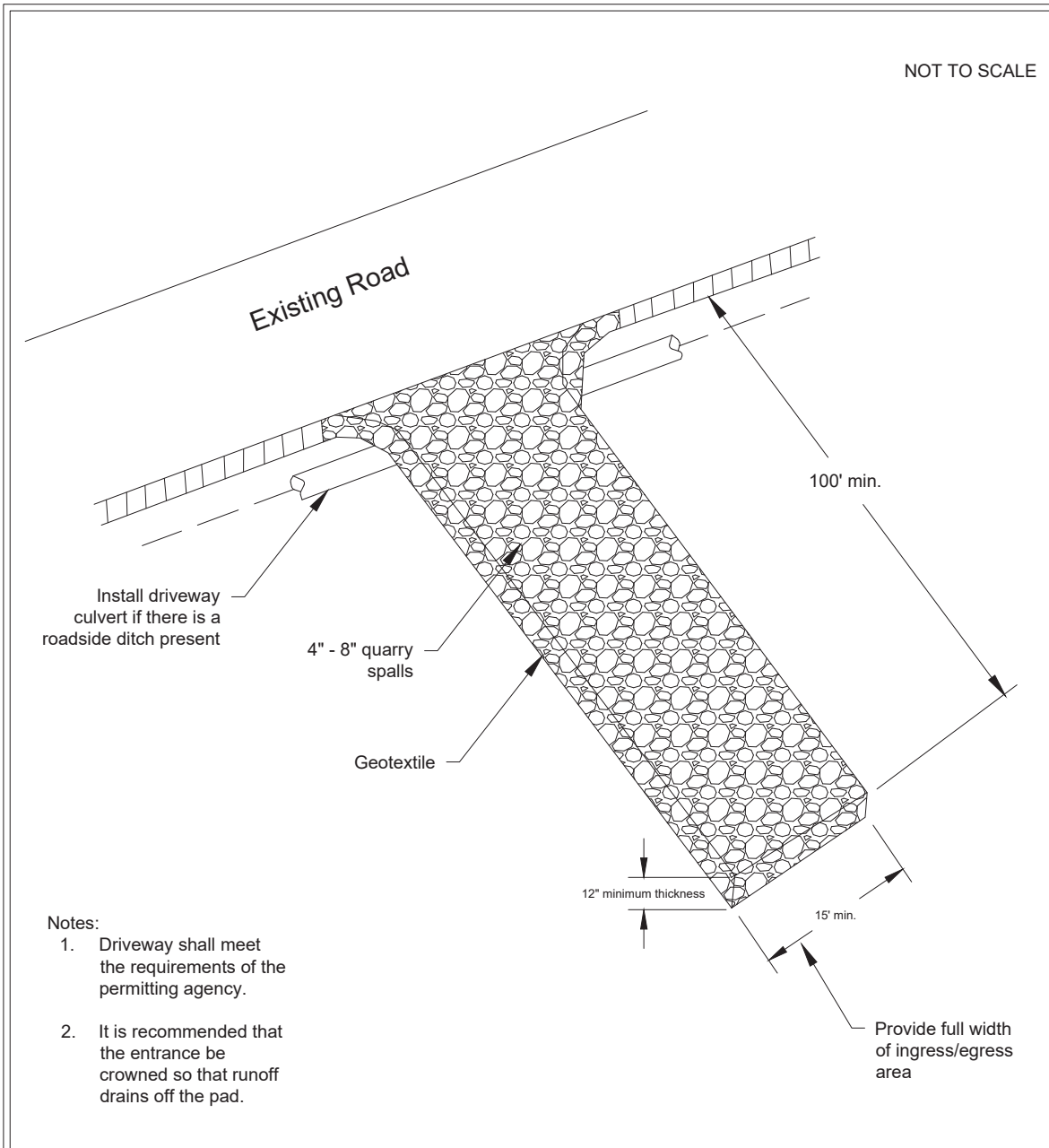
## ***Design and Installation***

- See [Figure 7.3: Stabilized Construction Entrance](#) for details.

**Note:** The 100-foot minimum length of the entrance shall be reduced to the maximum practicable size when the size or configuration of the site does not allow the full length (100 feet).

- Construct stabilized construction entrances with a 12-inch thick pad of 4- to 8-inch quarry spalls, a 4-inch course of asphalt treated base (ATB), or use existing pavement. Do not use crushed concrete, cement, or calcium chloride for construction entrance stabilization because these products increase pH levels in stormwater, and concrete discharge to surface waters of the state is prohibited.
- A separation geotextile shall be placed under the spalls to prevent fine sediment from pumping up into the rock pad. The geotextile shall meet the following standards listed in [Table 7.1: Stabilized Construction Entrance Geotextile Standards](#).

**Figure 7.3: Stabilized Construction Entrance**



## Stabilized Construction Entrance

Revised June 2016

Please see <http://www.ecy.wa.gov/copyright.html> for copyright notice including permissions, limitation of liability, and disclaimer.

**Table 7.1: Stabilized Construction Entrance Geotextile Standards**

Geotextile Property	Required Value
Grab Tensile Strength (ASTM D4751)	200 pounds per square inch (psi) minimum
Grab Tensile Elongation (ASTM D4632)	30% maximum
Mullen Burst Strength (ASTM D3786-80a)	400 psi minimum
Apparent Opening Size (ASTM D4751)	No. 20 to No. 45 (U.S. standard sieve size)

- Consider early installation of the first lift of asphalt in areas that will be paved; this can be used as a stabilized entrance. Also consider the installation of excess concrete as a stabilized entrance. During large concrete pours, excess concrete is often available for this purpose.
- Fencing (see [BMP C103E: High-Visibility Fence](#)) shall be installed as necessary to restrict traffic to the construction entrance.
- Whenever possible, the entrance shall be constructed on a firm, compacted subgrade. This can substantially increase the effectiveness of the pad and reduce the need for maintenance.
- Construction entrances should avoid crossing existing sidewalks and back of walk drains if at all possible. If a construction entrance must cross a sidewalk or back of walk drain, the full length of the sidewalk and back of walk drain must be covered and protected from sediment leaving the site.
- Alternative material specification:
  - The Washington State Department of Transportation (WSDOT) has raised safety concerns about the quarry spall rock specified in the second bullet in the Design and Installation subsection. WSDOT has noticed that rocks measuring 4 to 8 inches can become trapped between dually truck tires and subsequently released off-site at highway speeds. WSDOT has chosen to use a modified specification for the rock while continuously verifying that the stabilized construction entrance remains effective. To remain effective, the BMP must prevent sediment from migrating off-site. To date, there has been no performance testing to verify operation of this new specification. Local jurisdictions may use the alternative specification, but must perform increased off-site inspections
  - Stabilized construction entrances may use material that meets the requirements of the latest version of WSDOT's *Standard Specifications for Road, Bridge, and Municipal Construction* for ballast unless the alternative grading and quality requirements listed in [Table 7.2: Stabilized Construction Entrance Alternative Material Requirements](#) are used.

**Table 7.2: Stabilized Construction Entrance Alternative Material Requirements**

Sieve Size	Percentage Passing
2.5 inches	99 to 100
2 inch	65 to 100
3/4 inch	40 to 80
No. 4	5 maximum
No. 100	0 to 2
% Fracture	75 minimum
<p>Notes: All percentages are by weight.</p> <p>The sand equivalent value and dust ratio requirements do not apply.</p> <p>The fracture requirement shall be at least one fractured face and will apply the combined aggregate retained on the No. 4 sieve in accordance with FOP for AASHTO T 335.</p>	

### **Maintenance Standards**

Quarry spalls shall be added if the pad is no longer in accordance with the specifications.

- If the entrance is not preventing sediment from being tracked onto pavement, then alternative measures to keep the streets free of sediment shall be used. This may include replacement/cleaning of the existing quarry spalls, street sweeping, an increase in the dimensions of the entrance, or the installation of [BMP C106E: Wheel Wash](#).
- Any sediment that is tracked onto pavement shall be removed by shoveling or street sweeping. The sediment collected by sweeping shall be removed or stabilized on-site. The pavement shall not be cleaned by washing down the street, except when sweeping is ineffective and there is a threat to public safety. If it is necessary to wash the streets, the construction of a small sump to contain the washwater shall be considered. The sediment would then be washed into the sump where it can be controlled.
- Perform street sweeping by hand or with a high-efficiency sweeper. Do not use a non-high-efficiency mechanical sweeper because this creates dust and throws soils into storm systems or conveyance ditches.
- Any quarry spalls that are loosened from the pad, which end up on the roadway shall be removed immediately.
- If vehicles are entering or exiting the site at points other than the construction entrance(s) [BMP C103E: High-Visibility Fence](#) shall be installed to control traffic.
- Upon project completion and site stabilization, all construction accesses intended as permanent access for maintenance shall be permanently stabilized.

## ***Approved as Functionally Equivalent***

The Washington State Department of Ecology (Ecology) has approved products as able to meet the requirements of this BMP. The products did not pass through the Technology Assessment Protocol–Ecology (TAPE) process. Local jurisdictions may choose not to accept these products or may require additional testing prior to consideration for local use. Products that Ecology has approved as functionally equivalent are available for review on Ecology’s Emerging Stormwater Treatment Technologies (TAPE) web page at the following address:

<https://ecology.wa.gov/Regulations-Permits/Guidance-technical-assistance/Stormwater-permittee-guidance-resources/Emerging-stormwater-treatment-technologies>

## **BMP C106E: Wheel Wash**

### ***Purpose***

Wheel washes reduce the amount of sediment transported onto paved roads by washing dirt from the wheels of motor vehicles prior to the motor vehicles leaving the construction site.

### ***Conditions of Use***

- Use a wheel wash when [BMP C105E: Stabilized Construction Access](#) is not preventing sediment from being tracked off-site.
- Wheel washing is generally an effective BMP when installed with careful attention to topography. For example, a wheel wash can be detrimental if installed at the top of a slope abutting a right-of-way where the water from the dripping truck can run unimpeded into the street.
- Pressure washing combined with an adequately sized and surfaced pad with direct drainage to a large 10- by 10-foot sump can be very effective.
- Wheel wash wastewater is process water and must be discharged to a separate on-site treatment system that prevents discharge to a receiving water or to the sanitary sewer with local sewer district approval.
- Wheel washes may use closed-loop recirculation systems to conserve water use.
- Wheel wash wastewater shall not include wastewater from concrete washout areas.
- When practical, the wheel wash should be placed in sequence with [BMP C105E: Stabilized Construction Access](#). Locate the wheel wash such that vehicles exiting the wheel wash will enter directly onto the stabilized construction entrance/exit. To achieve this, the entrance/exit may need to be extended beyond the standard installation to meet the exit of the wheel wash.

### ***Design and Installation Specifications***

- Suggested details are shown in [Figure 7.4: Wheel Wash](#). The local permitting authority may allow other designs. A minimum of 6 inches of asphalt treated base (ATB) over crushed base material or 8 inches over a good subgrade is recommended to pave the wheel wash.
- Use a low-clearance truck to test the wheel wash before paving. Either a belly dump or

lowboy will work well to test clearance.

- Keep the water level from 12 to 14 inches deep to avoid damage to truck hubs and filling the truck tongues with water.
- Midpoint spray nozzles are needed only in extremely muddy conditions.
- Wheel wash systems should be designed with a small grade change, 6 to 12 inches for a 10-foot-wide pond, to allow sediment to flow to the low side of the pond to help prevent resuspension of sediment. A drainpipe with a 2- to 3-foot riser should be installed on the low side of the pond to allow easy cleaning and refilling. Polymers may be used to promote coagulation and flocculation in a closed-loop system. Polyacrylamide (PAM) added to the wheel washwater at a rate of 0.25 to 0.5 pounds per 1,000 gallons of water increases effectiveness and reduces cleanup time. If PAM is already being used for dust or erosion control and is being applied by a water truck, the same truck can be used to change the washwater.

### ***Maintenance Standards***

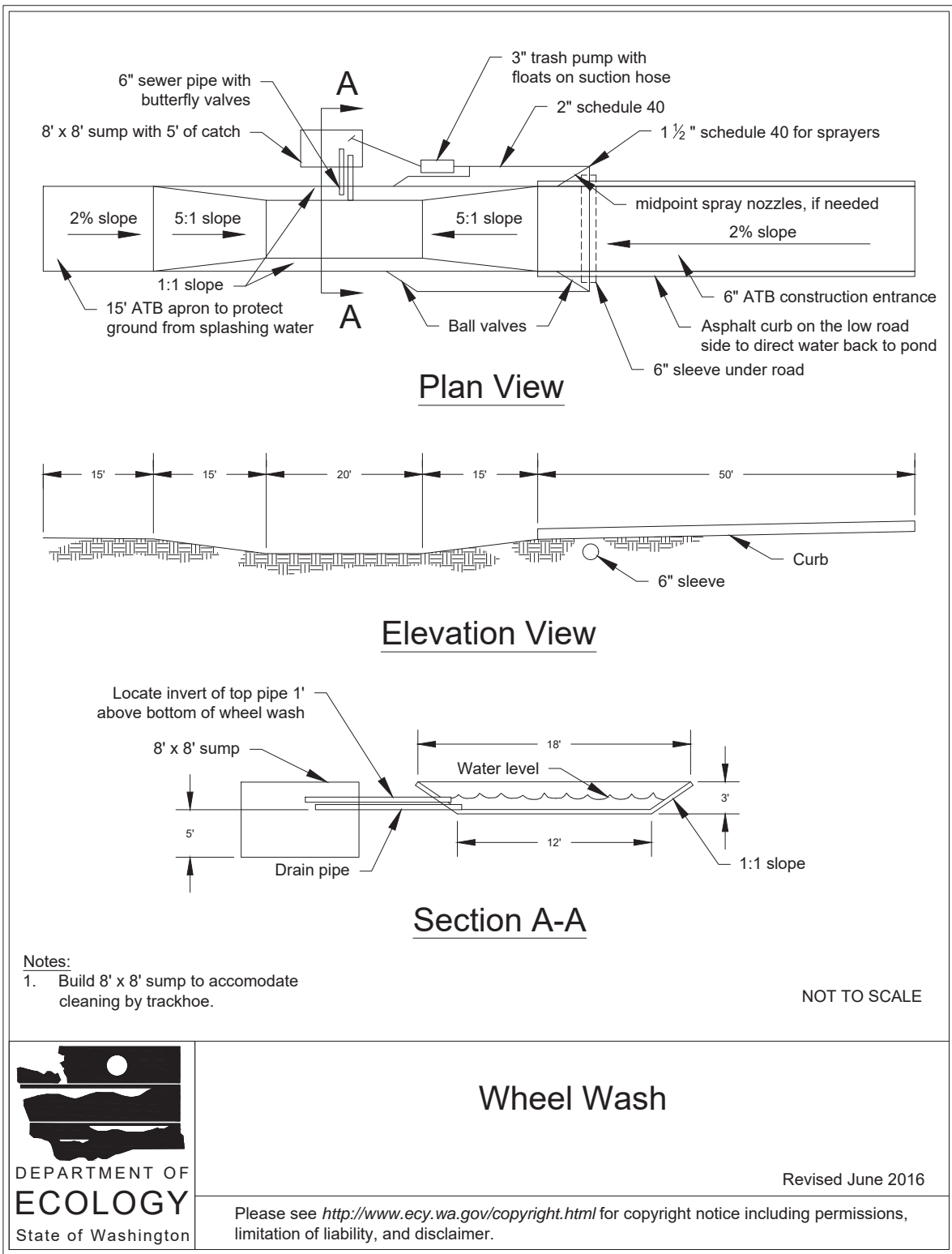
- The wheel wash should start out each day with fresh water.
- The washwater for the wheel wash should be changed a minimum of once per day. On large earthwork jobs where more than 10 to 20 trucks per hour are expected, the wheel washwater will need to be changed more often.

### ***Approved as Functionally Equivalent***

The Washington State Department of Ecology (Ecology) has approved products as able to meet the requirements of this BMP. The products did not pass through the Technology Assessment Protocol–Ecology (TAPE) process. Local jurisdictions may choose not to accept these products or may require additional testing prior to consideration for local use. Products that Ecology has approved as functionally equivalent are available for review on Ecology’s Emerging Stormwater Treatment Technologies (TAPE) web page at the following address:

<https://ecology.wa.gov/Regulations-Permits/Guidance-technical-assistance/Stormwater-permittee-guidance-resources/Emerging-stormwater-treatment-technologies>

**Figure 7.4: Wheel Wash**



## **BMP C107E: Construction Road/Parking Area Stabilization**

### ***Purpose***

Stabilizing roads, parking areas, and other on-site vehicle transportation routes immediately after grading reduces erosion caused by construction traffic or stormwater runoff.

### ***Conditions of Use***

- Roads and parking areas shall be stabilized wherever they are constructed, whether permanent or temporary, for use by construction traffic.
- [BMP C103E: High-Visibility Fence](#) shall be installed, if necessary, to limit the access of vehicles to only those roads and parking areas that are stabilized.

### ***Design and Installation Specifications***

- On areas that will receive asphalt as part of the project, install the first lift as soon as possible.
- A 6-inch depth of 2- to 4-inch crushed rock, gravel base, or crushed surfacing base course shall be applied immediately after grading or utility installation. A 4-inch course of asphalt treated base (ATB) may also be used, or the road/parking area may be paved. It may also be possible to use cement or calcium chloride for soil stabilization. If cement or cement kiln dust is used for road base stabilization, pH monitoring and implementation of [BMP C252E: Treating and Disposing of High pH Water](#) is necessary to evaluate and minimize the effects on stormwater. If the area will not be used for permanent roads, parking areas, or structures, a 6-inch depth of hog fuel may also be used, but this is likely to require more maintenance. Whenever possible, construction roads and parking areas shall be placed on a firm, compacted subgrade.
- Temporary road gradients shall be < 15%. Roadways shall be carefully graded to drain. Drainage ditches shall be provided on each side of the roadway in the case of a crowned section, or on one side in the case of a superelevated section. Drainage ditches shall be directed to a sediment control BMP.
- Rather than relying on ditches, it may also be possible to grade the road so that runoff sheet-flows into a heavily vegetated area with a well-developed topsoil. Landscaped areas are not adequate. If this area has ≥ 50 feet of vegetation, then it is generally preferable to use the vegetation to treat runoff, rather than a sediment pond or trap. The 50 feet shall not include wetlands. If runoff is allowed to sheet flow through adjacent vegetated areas, it is vital to design the roadways and parking areas so that no concentrated runoff is created.
- Storm drain inlets shall be protected to prevent sediment-laden water from entering the drainage system (see [BMP C220E: Inlet Protection](#)).

### ***Maintenance Standards***

- Inspect stabilized areas regularly, especially after large storm events.
- Crushed rock, gravel base, etc., shall be added as required to maintain a stable driving surface and to stabilize any areas that have eroded.



- Following construction, these areas shall be restored to preconstruction condition or better to prevent future erosion.
- Perform street cleaning at the end of each day or more often if necessary.

## **BMP C120E: Temporary and Permanent Seeding**

### ***Purpose***

Seeding reduces erosion by stabilizing exposed soils. A well-established vegetative cover is one of the most effective methods of reducing erosion.

### ***Conditions of Use***

- Use seeding throughout the project on disturbed areas that have reached final grade or that will remain unworked for > 30 days. See [Element #5: Stabilize Soils](#) for specific timelines for stabilizing exposed soils.
- The optimum permanent seeding window for eastern Washington is October 1 through November 15.
- The acceptable permanent seeding window for eastern Washington is September 1 through April 30.
- Seeding permanent species is not recommended for eastern Washington from May 1 through August 31, unless irrigation is conducted.
- Review all disturbed areas in late August to early September and complete all seeding by the end of April. Otherwise, vegetation will not establish itself well enough to provide more than average protection.
- Mulch is required at all times for seeding because it protects seeds from heat, moisture loss, and transport due to runoff. Mulch can be applied on top of the seed or simultaneously by hydroseeding. See [BMP C121E: Mulching](#) for specifications.
- Seed and mulch all disturbed areas not otherwise vegetated at final site stabilization. Final stabilization means the completion of all soil disturbing activities at the site and the establishment of a permanent vegetative cover, or equivalent permanent stabilization measures (such as pavement, riprap, gabions or geotextiles) which will prevent erosion. See [BMP F6.61: Amending Construction Site Soils](#).

## ***Design and Installation Specifications***

### **General**

- Install channels intended for vegetation before starting major earthwork and hydroseed with a bonded fiber matrix (BFM). For vegetated channels that will have high flows, install erosion control blankets over hydroseed. Before allowing water to flow in vegetated channels, establish a 50% vegetation cover of all seeded areas after 3 months of active growth following germination during the growing season. If vegetated channels cannot be established by seed before water flow, install sod or prevegetated mats in the channel bottom over hydromulch

and blankets.

- Confirm the installation of all required stormwater control measures to prevent seed from washing away.
  - Hydroseed applications shall include a minimum of 1,500 pounds per acre (lb/acre) of mulch with 3% tackifier.
  - Mulch is always required for seeding. Apply mulch on top of the seed or simultaneously by hydroseeding. See [BMP C121E: Mulching](#) for specifications.
  - Areas that will have seeding only and not landscaping may need compost or meal-based mulch included in the hydroseed in order to establish vegetation. Reinstall native topsoil on the disturbed soil surface before application. See [BMP F6.61: Amending Construction Site Soils](#) in [Chapter 6 - Flow Control BMP Design](#).
  - When installing seed via hydroseeding operations, only about one-third of the seed actually ends up in contact with the soil surface. This reduces the ability to establish a good stand of grass quickly. One way to overcome this is to increase seed quantities by up to 50%.
  - Vegetation establishment can be enhanced by one of the following two approaches:
    - Approach 1: Enhance vegetation establishment by dividing the hydromulch operation into two phases:
      - Phase 1 – Install all seed and fertilizer with 25% to 30% mulch and tackifier onto the soil in the first lift.
      - Phase 2 – Install the remaining mulch and tackifier over the first lift.
    - Approach 2: Vegetation can also be enhanced by:
      - Installing the mulch, seed, fertilizer, and tackifier in one lift;
      - Spreading or blowing straw over the top of the hydromulch at a rate of about 800 to 1,000 lb/acre; or
      - Holding straw in place with a standard tackifier.
    - Both of these approaches (Approach 1 and Approach 2) will increase cost moderately but will greatly improve and enhance vegetative establishment. The increased cost may be offset by the reduced need for:
      - Irrigation,
      - Reapplication of mulch, and
      - Repair of failed slope surfaces.
- Either of these approaches can use standard hydromulch (1,500 lb/acre minimum) and BFM/mechanically bonded fiber matrix (MBFM) (3,000 lb/acre minimum).
- Seed may be installed by hand if it is:

- Temporary and covered by straw, mulch, or topsoil; or
- Permanent in small areas (usually < 1 acre) and covered with mulch, topsoil, or erosion blankets.
- The seed mixes listed in [Table 7.3: Temporary Seeding](#) through [Table 7.12: Permanent Seed Mixes: Stabilization of Ski Slopes and Subalpine Areas](#) include recommended mixes for both temporary and permanent seeding. Alternative seed mixes approved by the local jurisdiction may be used.
- Because it is difficult to generalize soil and climate conditions in eastern Washington, the project proponent is directed to check with the local suppliers or the local conservation district for appropriate seed mixes and application rates for their site based on a variety of factors, including location, exposure, soil type, slope, and expected foot traffic.
- In addition to meeting erosion control functions and not hindering maintenance operations, selection of long-lived, successional growth native vegetation that can compete against or exclude weeds and grow with minimal maintenance after plant establishment is preferred. Provide diversity to the greatest extent possible and plan for a succession of flowering times to improve pollinator habitat.

[Table 7.3: Temporary Seeding](#) shows seeding rates for four different seed mixes (A, B, C, and D) for the temporary stabilization of disturbed areas until permanent vegetation or other long-term erosion control measures can be established. These annual plants will generally not survive more than one growing season.

**Table 7.3: Temporary Seeding**

Common Name	Seeding Rate for Four Seed Mixes (lb/acre)			
	A	B	C	D
Winter or spring wheat (I)	80			
Spring barley (I)		80		
Regreen (I) <sup>a</sup> or triticale (I)			50	
Annual ryegrass (I)				15
<sup>a</sup> Sterile wheat x wheatgrass hybrid				
I = introduced, nonnative plant species				

[Table 7.4: Permanent Seed Mixes: Upland Areas with Less than 12 Inches Precipitation](#) shows three different erosion control seed mixes (A, B, and C) for upland areas that receive less than 12 inches effective precipitation. For each, drilled seeding rates are given (in lb/acre); double seed rates if broadcast or hydroseeded. Consideration should be given to the traffic hazard for wildlife when selecting food species for roadside stabilization.

**Table 7.4: Permanent Seed Mixes: Upland Areas with Less than 12 Inches Precipitation**

Common Name	Seeding Rate for Three Seed Mixes (lb/acre) <sup>a</sup>		
	A	B	C
Crested or Siberian wheatgrass* (droughty, coarse soils) (I)	7		
Bluebunch wheatgrass (N)		7	
Indian ricegrass (sandy soil)(N)	2		
Thickspike wheatgrass (N)			8
Sheep fescue (I)		1	1
Big bluegrass (N) or needle and thread grass (N)	1	1	
TOTAL	10	9	9
Seeds/sq ft/mixture	63	56	64
<sup>a</sup> Expressed as pure live seed I = introduced, nonnative plant species N = native plant species sf = square feet			

[Table 7.5: Permanent Seed Mixes: Upland Areas That Receive 12 to 15 Inches Precipitation](#) shows three different erosion control seed mixes (A, B, and C) for upland areas that receive 12 to 15 inches effective precipitation. For each, drilled seeding rates are given (in lb/acre); double seed rates if broadcast or hydroseeded. Consideration should be given to the traffic hazard for wildlife when selecting food species for roadside stabilization.

**Table 7.5: Permanent Seed Mixes: Upland Areas That Receive 12 to 15 Inches Precipitation**

Common Name	Seeding Rate for Three Seed Mixes (lb/acre) <sup>a</sup>		
	A	B	C
Bluebunch or beardless wheatgrass (N)		8	
Pubescent wheatgrass (I)			7
Indian ricegrass (sandy or sandy loam soils) (N)	2		
Thickspike wheatgrass (N)	7		2
Sheep fescue (I)		1	2
Basin wildrye (N)		1	
TOTAL	9	10	11
Seeds/sf/mixture	53	63	49
<sup>a</sup> Expressed as pure live seed I = introduced, nonnative plant species N = native plant species sf = square feet			

[Table 7.6: Permanent Seed Mixes: Upland Areas With 15 to 18 Inches Precipitation](#) shows two different erosion control seed mixes (A and B) for upland areas that receive 15 to 18 inches effective precipitation. For each, drilled seeding rates are given (in lb/acre); double seed rates if broadcast or hydroseeded. Consideration should be given to the traffic hazard for wildlife when selecting food species for roadside stabilization.

**Table 7.6: Permanent Seed Mixes: Upland Areas With 15 to 18 Inches Precipitation**

Common Name	Seeding Rate for Two Seed Mixes (lb/acre) <sup>a</sup>	
	A	B
Bluebunch wheatgrass (N) or beardless wheatgrass (N)	8	
Pubescent wheatgrass (I) or intermediate wheatgrass (I) or thickspike wheatgrass (N)		8
Hard fescue (I) or sheep fescue (I)	2	2
Big bluegrass (N)	1	1
Native legume (N)	2	2
TOTAL	9	10
Seeds/sf/mixture	70	72
<sup>a</sup> Expressed as pure live seed I = introduced, nonnative plant species N = native plant species sf = square feet		

[Table 7.7: Permanent Seed Mixes: Upland Areas With 18 to 24 Inches Precipitation](#) shows three different erosion control seed mixes (A, B, and C) for upland areas that receive 18 to 24 inches effective precipitation. For each, drilled seeding rates are given (in lb/acre); double seed rates if broadcast or hydroseeded. Consideration should be given to the traffic hazard for wildlife when selecting food species for roadside stabilization.

**Table 7.7: Permanent Seed Mixes: Upland Areas With 18 to 24 Inches Precipitation**

Common Name	Seeding Rate for Three Seed Mixes (lb/acre) <sup>a</sup>		
	A	B	C
Slender wheatgrass (N) or sodar streambank wheatgrass	7		
Blue wildrye (N)		8	
Mountain brome (N)	1		8
Hard fescue (I)	2	2	2
White clover (I) or red clover (I)			2

**Table 7.7: Permanent Seed Mixes: Upland Areas With 18 to 24 Inches Precipitation (continued)**

Common Name	Seeding Rate for Three Seed Mixes (lb/acre) <sup>a</sup>		
	A	B	C
Native lupine (N) or northern sweetvetch (N)		2	
Native clover spp. (N) or milkvetch spp. (N)	2		
TOTAL	12	12	12
Seeds/sf/mixture	64	62	76
<sup>a</sup> Expressed as pure live seed I = introduced, nonnative plant species N = native plant species sf = square feet			

[Table 7.8: Permanent Seed Mixes: Upland Areas With More Than 24 Inches Precipitation](#) shows two different erosion control seed mixes (A and B) for upland areas that receive > 24 inches effective precipitation. For each, drilled seeding rates are given (in lb/acre); double seed rates if broadcast or hydroseeded. Consideration should be given to the traffic hazard for wildlife when selecting food species for roadside stabilization.

**Table 7.8: Permanent Seed Mixes: Upland Areas With More Than 24 Inches Precipitation**

Common Name	Seeding Rate for Two Seed Mixes (lb/acre) <sup>a</sup>	
	A	B
Hard fescue (I)		2
Blue wildrye (N)	6	
Red fescue (I)	1	
Mountain brome (N)	2	4
Slender wheatgrass (N)		4
White clover (I)	2	
Native legume (N)		2
TOTAL	11	12

**Table 7.8: Permanent Seed Mixes: Upland Areas With More Than 24 Inches Precipitation (continued)**

Common Name	Seeding Rate for Two Seed Mixes (lb/acre) <sup>a</sup>	
	A	B
Seeds/sf/mixture	72	61
<sup>a</sup> Expressed as pure live seed I = introduced, nonnative plant species N = native plant species sf = square feet		

[Table 7.9: Permanent Seed Mixes: Grassed Waterways With Fewer Than 15 Inches Precipitation](#) shows three different erosion control seed mixes (A, B, and C) for stabilizing grassed waterways in areas that receive fewer than 15 inches effective precipitation. For each, drilled seeding rates are given (in lb/acre); double seed rates if broadcast or hydroseeded. Consideration should be given to the traffic hazard for wildlife when selecting food species for roadside stabilization.

**Table 7.9: Permanent Seed Mixes: Grassed Waterways With Fewer Than 15 Inches Precipitation**

Common Name	Seeding Rate for Three Seed Mixes (lb/acre) <sup>a</sup>		
	A	B	C
Pubescent wheatgrass (I)		10	
Streambank wheatgrass (N)			7
Thickspike wheatgrass (N)	7		
Sheep fescue (I)		2	2
Big bluegrass (N)	2		
TOTAL	9	12	9
Seeds/sf/mixture	66	48	56
<sup>a</sup> Expressed as pure live seed I = introduced, nonnative plant species N = native plant species sf = square feet			



[Table 7.10: Permanent Seed Mixes: Grassed Waterways With 15 to 18 Inches Precipitation](#) shows three different erosion control seed mixes (A, B, and C) for stabilizing grassed waterways in areas that receive 15 to 18 inches effective precipitation. For each, drilled seeding rates are given (in lb/acre); double seed rates if broadcast or hydroseeded. Consideration should be given to the traffic hazard for wildlife when selecting food species for roadside stabilization.

**Table 7.10: Permanent Seed Mixes: Grassed Waterways With 15 to 18 Inches Precipitation**

Common Name	Seeding Rate for Three Seed Mixes (lb/acre) <sup>a</sup>		
	A	B	C
Tall wheatgrass (I)	10		
Pubescent wheatgrass (I), streambank wheatgrass (N), or intermediate wheatgrass (I)		10	
Hard fescue (I) or sheep fescue (I)	2	2	2
Thickspike wheatgrass (N)			8
TOTAL	12	12	10
Seeds/sf/mixture	46	48	57
<sup>a</sup> Expressed as pure live seed I = introduced, nonnative plant species N = native plant species sf = square feet			

[Table 7.11: Permanent Seed Mixes: Grassed Waterways With More Than 18 Inches Precipitation](#) shows three different erosion control seed mixes (A, B, and C) for stabilizing grassed waterways in areas that receive more than 18 inches effective precipitation. For each, drilled seeding rates are given (in lb/acre); double seed rates if broadcast or hydroseeded. Consideration should be given to the traffic hazard for wildlife when selecting food species for roadside stabilization.

**Table 7.11: Permanent Seed Mixes: Grassed Waterways With More Than 18 Inches Precipitation**

Common Name	Seeding Rate for Three Seed Mixes (lb/acre) <sup>a</sup>		
	A	B	C
Intermediate wheatgrass (I)	10		
Mountain brome (N) or meadow brome		10	
Annual ryegrass (I) or perennial ryegrass (I)	4		
Hard fescue (I)		2	
Tall wheatgrass (I)			10
TOTAL	14	12	10
Seeds/sf/mixture	40	46	38
<sup>a</sup> Expressed as pure live seed I = introduced, nonnative plant species N = native plant species sf = square feet			

[Table 7.12: Permanent Seed Mixes: Stabilization of Ski Slopes and Subalpine Areas](#) shows two different erosion control seed mixes (A and B) for stabilizing ski slopes and subalpine areas in eastern Washington. For each, drilled seeding rates are given (in lb/acre); double seed rates if broadcast or hydroseeded. Consideration should be given to the traffic hazard for wildlife when selecting food species for roadside stabilization.

**Table 7.12: Permanent Seed Mixes: Stabilization of Ski Slopes and Subalpine Areas**

Common Name	Seeding Rate for Three Seed Mixes (lb/acre) <sup>a</sup>	
	A	B
Blue wildrye (N) or Idaho fescue (N)	10	
Pubescent wheatgrass (I) or red fescue (I)		8
Hard fescue (I)		5
Sheep fescue (I)	2	2
White clover (I) or bentgrasses (I)		2
Lupine (N)	2	

**Table 7.12: Permanent Seed Mixes: Stabilization of Ski Slopes and Subalpine Areas (continued)**

Common Name	Seeding Rate for Three Seed Mixes (lb/acre) <sup>a</sup>	
	A	B
TOTAL	14	17
<sup>a</sup> Expressed as pure live seed I = introduced, nonnative plant species N = native plant species		

**Roughening and Rototilling**

- The seedbed should be firm and rough. Roughen all soil no matter what the slope. Track walk slopes before seeding if engineering purposes require compaction. Back-blading or smoothing of slopes > 4H:1V is not allowed if they are to be seeded.
- Restoration-based landscape practices require deeper incorporation than that provided by a simple single-pass rototilling treatment. Wherever practical, initially rip the subgrade to improve long-term permeability, infiltration, and water inflow qualities. At a minimum, permanent areas shall receive soil amendments to achieve organic matter and permeability performance defined in amended soil/landscape systems. For systems that are deeper than 8 inches, complete the rototilling process in multiple lifts, or prepare the soil amendments to achieve the specified depth.

**Fertilizers**

- Conducting soil tests to determine the exact type and quantity of fertilizer needed is recommended. This will prevent the overapplication of fertilizer.
- Organic matter is the most appropriate form of fertilizer because it provides nutrients (including nitrogen, phosphorus, and potassium) in the least water-soluble form. A natural system typically releases 20% to 10% of its nutrients annually. Chemical fertilizers have been formulated to simulate what organic matter does naturally.
- Always use slow-release fertilizers because they are more efficient and have fewer environmental impacts. Do not add fertilizer to the hydromulch machine, or agitate, more than 20 minutes before use. Too much agitation destroys the slow release coating.

There are numerous products available to take the place of chemical fertilizers, including several with seaweed extracts that are beneficial to soil microbes and organisms. If 100% cottonseed meal is used as the mulch in hydroseed, chemical fertilizer may not be necessary. Cottonseed meal provides a good source of long-term, slow-release, available nitrogen.

**Bonded Fiber Matrix and Mechanically Bonded Fiber Matrix**

- On steep slopes, use BFM or MBFM products. Apply BFM/MBFM products at a minimum rate of 3,000 lb per acre of mulch with approximately 10% tackifier. Achieve a minimum of 95% soil coverage during application. Numerous products are available commercially. Install products per manufacturer's instructions. Most products require 24 to 36 hours to cure before a rainfall and cannot be installed on wet or saturated soils. Generally, products come in 40- to 50-pound bags and include all necessary ingredients except for seed and fertilizer.
- BFMs and MBFMs provide good alternatives to blankets in most areas requiring vegetation establishment. Advantages over blankets include the following:
  - BFM and MBFMs do not require surface preparation.
  - Helicopters can assist in installing BFM and MBFMs in remote areas.
  - On slopes steeper than 2.5H:1V, blanket installers may require ropes and harnesses for safety.
  - Installing BFM and MBFMs can save at least \$1,000 per acre compared to blankets.
- In most cases, the shear strength of blankets is not a factor when used on slopes, only when used in channels.
  - Areas to be permanently landscaped shall provide a healthy topsoil or amend the existing soil to reduce the need for fertilizers, improve overall topsoil quality, provide for better plant health and vitality, improve hydrologic characteristics, and reduce the need for irrigation.
  - Areas that already have good topsoil, such as undisturbed areas, do not require soil amendments.

### ***Maintenance Standards***

- Reseed any seeded areas that fail to establish  $\geq 50\%$  cover (100% cover for areas that receive sheet or concentrated flows) of all seeded areas after 3 months of active growth following germination during the growing season. If reseeding is ineffective, use an alternative method, such as sodding, mulching, or nets/blankets. If winter weather prevents adequate grass growth, this time limit may be relaxed at the discretion of the local authority when sensitive areas would otherwise be protected.
- Reseed and protect by mulch any areas that experience erosion after achieving adequate cover. If the erosion problem is drainage related, the problem shall be fixed and the eroded area reseeded and protected by mulch.
- Seeded areas shall be supplied with adequate moisture, but not watered to the extent that causes runoff.

### ***Approved as Equivalent***

The Washington State Department of Ecology (Ecology) has approved products as able to meet the requirements of [BMP C120E: Temporary and Permanent Seeding](#). The products did not pass through the Technology Assessment Protocol–Ecology (TAPE) process. Local jurisdictions may choose not to accept this product approved as equivalent or may require additional testing prior to

consideration for local use. The products are available for review on Ecology's Emerging Stormwater Treatment Technologies (TAPE) web page at the following address:

<https://ecology.wa.gov/Regulations-Permits/Guidance-technical-assistance/Stormwater-permittee-guidance-resources/Emerging-stormwater-treatment-technologies>

## **BMP C121E: Mulching**

### ***Purpose***

The purpose of mulching soils is to provide immediate temporary protection from erosion. Mulch also enhances plant establishment by conserving moisture; holding fertilizer, seed, and topsoil in place; and moderating soil temperatures. There are a variety of mulches available for use. Only the most common types are discussed in this section.

### ***Conditions of Use***

- As a temporary cover measure, mulch should be used:
  - For < 30 days on disturbed areas that require cover;
  - At all times for seeded areas, especially during the wet season and during the hot summer months; and
  - During the wet season on slopes steeper than 3H:1V with more than 10 feet of vertical relief.
- Mulch may be applied at any time of the year and must be refreshed periodically.
- For seeded areas, mulch may consist of 100% of the following:
  - Cottonseed meal
  - Fibers made of wood, recycled cellulose, hemp, or kenaf
  - Compost
  - A blend of these three materials
- Tackifier shall be plant-based, such as guar or *Alpha plantago*, or chemical-based such as polyacrylamide (PAM) or polymers. Any mulch or tackifier product used shall be installed per manufacturer's instructions. Generally, mulches come in 40- to 50-pound bags. Seed and fertilizer are added at time of application.

### ***Design and Installation Specifications***

For mulch materials, application rates, and specifications see [Table 7.13: Mulch Standards and Guidelines](#). Always use a minimum mulch thickness of 2 inches; increase the thickness until the ground is 95% covered (i.e., not visible under the mulch layer).

**Note:** Thicknesses may be increased for disturbed areas in or near sensitive areas or other areas highly susceptible to erosion.

**Table 7.13: Mulch Standards and Guidelines**

<b>Mulch Material: Straw</b>	
Quality Standards	Air-dried; free from undesirable seed and coarse material.
Application Rates	2- to 3 inches thick; five bales per 1,000 sf or 2 to 3 tons per acre
Remarks	Cost-effective protection when applied with adequate thickness. Hand-application generally requires greater thickness than blown straw. The thickness of straw may be reduced by half when used in conjunction with seeding. In windy areas, straw must be held in place by crimping, using a tackifier, or covering with netting. Blown straw always has to be held in place with a tackifier because even light winds will blow it away. Straw, however, has several deficiencies that should be considered when selecting mulch materials. It often introduces and/or encourages the propagation of weed species, and it has no significant long-term benefits. Straw should be used only if mulches with long-term benefits are unavailable locally. It should also not be used within the ordinary high-water elevation of receiving waters (due to flotation).
<b>Mulch Material: Hydromulch</b>	
Quality Standards	No growth inhibiting factors.
Application Rates	Approximately 25 to 30 lb per 1,000 sf or 1,000 to 1,300 lb per acre.
Remarks	Shall be applied with hydromulcher. Shall not be used without seed and tackifier unless the application rate is at least doubled. Fibers > 0.75 to 1 inch can clog hydromulch equipment. Fibers should be kept to < 0.75 inch.
<b>Mulch Material: Compost</b>	
Quality Standards	No visible water or dust during handling. Must be produced per <a href="#">Chapter 173-350 WAC</a> , Solid Waste Handling Standards, but may have up to 35% biosolids.
Application Rates	2 inches thick at a minimum; approximately 100 tons per acre (approx. 750 lb per cubic yard).
Remarks	More effective control can be obtained by increasing thickness to 3 inches. Excellent mulch for protecting final grades until landscaping because it can be directly seeded or tilled into soil as an amendment. Compost used for mulch has a coarser size gradation than compost used for <a href="#">BMP C 125E: Topsoiling/Composting</a> or <a href="#">BMP F6.61: Amending Construction Site Soils</a> . It is more stable and practical to use in wet areas and during rainy weather conditions. Do not use near wetlands or near phosphorus-impaired water bodies.
<b>Mulch Material: Chipped Site Vegetation</b>	
Quality Standards	Average size shall be several inches. Gradations from fines to 6 inches in length for texture, variation, and interlocking properties.
Application Rates	2 inches thick at a minimum.
Remarks	This is a cost-effective way to dispose of debris from clearing and grubbing, and it eliminates

**Table 7.13: Mulch Standards and Guidelines (continued)**

	the problems associated with burning. Generally, it should not be used on slopes above approximately 10% because of its tendency to be transported by runoff. It is not recommended within 200 feet of receiving waters. If seeding is expected shortly after mulch, the decomposition of the chipped vegetation may tie up nutrients important to grass establishment.
<b>Mulch Material: Wood-Based Mulch or Wood Straw</b>	
Quality Standards	No visible water or dust during handling. Must be purchased from a supplier with a Solid Waste Handling Permit or one exempt from solid waste regulations.
Application Rates	2 inches thick; approximately 100 tons per acre (approximately 750 lb per cubic yard).
Remarks	This material is often called “hog or hogged fuel.” It is usable as a material for <a href="#">BMP C105E: Stabilized Construction Access</a> and as a mulch. The use of mulch ultimately improves the organic matter in the soil. Special caution is advised regarding the source and composition of wood-based mulch. Its preparation typically does not provide any weed seed control, so evidence of residual vegetation in its composition or known inclusion of weed plants or seeds should be monitored and prevented (or minimized).
<b>Mulch Material: Wood Strand Mulch</b>	
Quality Standards	A blend of loose, long, thin wood pieces derived from native conifers or deciduous trees with high length-to-width ratio.
Application Rates	2 inches thick at a minimum.
Remarks	Cost-effective protection when applied with adequate thickness. A minimum of 95% of the wood strand shall have lengths between 2 and 10 inches, with a width and thickness between 1/16 and 0.5 inches. The mulch shall not contain resin, tannin, or other compounds in quantities that would be detrimental to plant life. Sawdust or wood shavings shall not be used as mulch. See the latest version of the Washington State Department of Transportation <i>Standard Specifications for Road, Bridge, and Municipal Construction</i> .

Where the option of “compost” is selected, it should be a coarse compost that meets the size gradations listed in [Table 7.14: Size Gradations of Compost as Mulch Material](#) when tested in accordance with Test Method 02.02-B in *Test Methods for the Examination of Composting and Compost* ([Thompson, 2001](#)).

**Table 7.14: Size Gradations of Compost as Mulch Material**

Sieve Size	Percentage Passing
3 inch	100
1 inch	90 to 100
3/4 inch	70 to 100
1/4 inch	40 to 100

Mulch used within the ordinary high-water mark of receiving waters should be selected to minimize potential flotation of organic matter. Composted organic materials have higher specific gravities (densities) than straw, wood, or chipped material. Consult the Hydraulic Project Approval (HPA) for mulch mixes if applicable.

### **Maintenance Standards**

- The thickness of the mulch cover must be maintained.
- Any areas that experience erosion shall be remulched and/or protected with a net or blanket. If the erosion problem is drainage related, then the problem shall be fixed and the eroded area remulched.

## **BMP C122E: Nets and Blankets**

### **Purpose**

Erosion control nets and blankets are intended to prevent erosion and hold seed and mulch in place on steep slopes and in channels so that vegetation can become well established. In addition, some nets and blankets can be used to permanently reinforce turf to protect drainage systems during high flows.

Nets (commonly called matting) are strands of material woven into an open but high-tensile strength net (for example, coconut fiber matting and turf reinforcement mats [TRM]). Blankets are strands of material that are not tightly woven but instead form a layer of interlocking fibers, typically held together by a biodegradable or photodegradable netting (for example, excelsior or straw blankets). They generally have lower tensile strength than nets but cover the ground more completely. Coir (coconut fiber) fabric comes as both nets and blankets.

### **Conditions of Use**

Erosion control nets and blankets should be used for the following purposes:

- To aid permanent vegetated stabilization of slopes 2H:1V or greater and with more than 10 feet of vertical relief.
- For drainage ditches and swales (highly recommended). The application of appropriate netting or blanket to drainage ditches and swales can protect bare soil from channelized runoff while vegetation is established. Nets and blankets also can capture a great deal of sediment due to their open, porous structure. Synthetic nets and blankets can be used to permanently stabilize channels and may provide a cost-effective, environmentally preferable alternative to riprap. 100% synthetic blankets manufactured for use in ditches may be easily reused as temporary ditch liners.

Disadvantages of nets and blankets include the following:

- Surface preparation is required.
- On slopes steeper than 2.5H:1V, net and blanket installers may need to be roped and harnessed for safety.
- They cost at least \$4,000 to \$6,000 per acre installed.



Advantages of nets and blankets include the following:

- They can be installed without mobilizing special equipment.
- They can be installed by anyone with minimal training.
- They can be installed in stages or phases as the project progresses.
- Seed and fertilizer can be hand-placed by the installers as they progress down the slope.
- They can be installed in any weather.
- Numerous types of nets and blankets can be designed with various parameters in mind: fiber blend, mesh strength, longevity, biodegradability, cost, and availability.

An alternative to nets and blankets is BMP C202E (Riprap Channel Lining).

### ***Design and Installation Specifications***

- See [Figure 7.5: Channel Installation](#) and [Figure 7.6: Slope Installation](#) for typical orientation and installation of nets and blankets used in channels and as slope protection. Note: these are typical only; all nets and blankets must be installed per manufacturer's installation instructions.
- Installation is critical to the effectiveness of these products. If good ground contact is not achieved, runoff can concentrate under the product, resulting in significant erosion.
- Nets and blankets are installed on slopes according to the following procedure:
  1. Complete final grade and track walk up and down the slope. Soils should be raked and uniform prior to installing nets or blankets. To be effective, nets and blankets must have good adhesion to the soil.
  2. Install hydromulch with seed and fertilizer.
  3. Dig a small trench, approximately 12 inches wide by 6 inches deep along the top of the slope.
  4. Install the leading edge of the net/blanket into the small trench and staple approximately every 18 inches. Note: Staples are metal, U-shaped, and a minimum of 6 inches long. Longer staples are used in sandy soils. Biodegradable stakes are also available.
  5. Roll the net/blanket slowly down the slope as you walk backward. Note: The net/blanket rests against the installer's legs. Staples are installed as the net/blanket is unrolled. It is critical that the proper staple pattern is used for the net/blanket being installed. The net/blanket is not to be allowed to roll down the slope on its own as this stretches the net/blanket, making it impossible to maintain soil contact. In addition, no one is allowed to walk on the net/blanket after it is in place.
  6. If the net/blanket is not long enough to cover the entire slope length, allow the trailing edge of the upper net/blanket to overlap the leading edge of the lower net/blanket and staple it. On steeper slopes, this overlap should be installed in a small trench, stapled, and covered with soil.

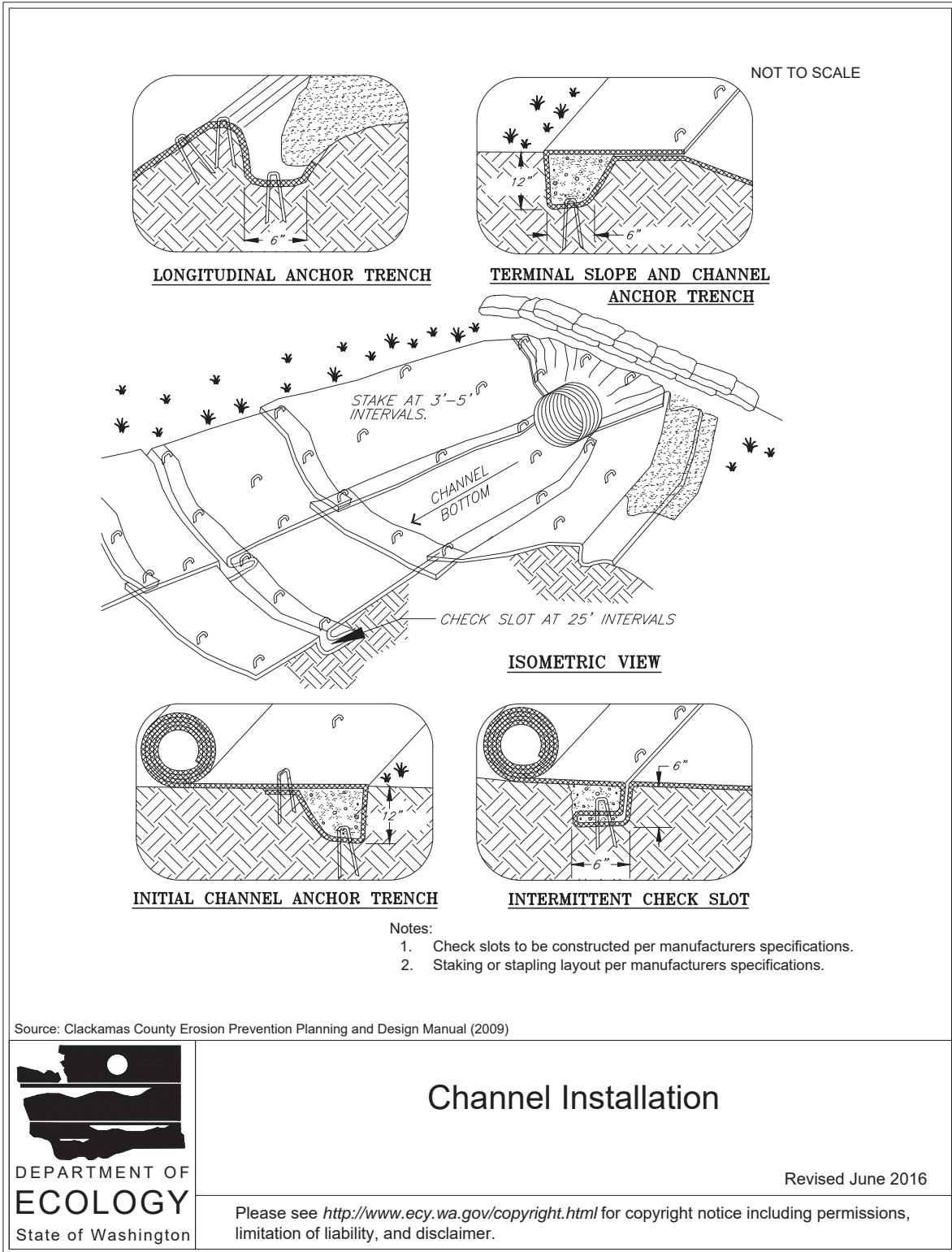
With the variety of products available, it is impossible to cover all the details of appropriate use and installation. Therefore, it is critical that the designer review the manufacturer's information and that a site visit take place in order to ensure that the specified product is appropriate. Information is also available in the latest version of the Washington State Department of Transportation *Standard Specifications for Road, Bridge, and Municipal Construction*.

- Jute matting must be used in conjunction with mulch ([BMP C121E: Mulching](#)). Excelsior, woven straw blankets, and coir (coconut fiber) blankets may be installed without mulch. There are many other types of erosion control nets and blankets on the market that may be appropriate in certain circumstances.
- In general, most nets (e.g., jute matting) require mulch in order to prevent erosion because they have a fairly open structure. Blankets typically do not require mulch because they usually provide complete protection of the surface.
- Extremely steep, unstable, wet, or rocky slopes are often appropriate candidates for use of synthetic blankets, as are riverbanks, beaches, and other high-energy environments. If synthetic blankets are used, the soil should be hydromulched first.
- For use in sensitive areas, 100% biodegradable blankets are available. These organic blankets are usually held together with a paper or fiber mesh and stitching, which may last up to a year.
- Most netting used with blankets is photodegradable, meaning it breaks down under sunlight (not ultraviolet [UV] stabilized). However, this process can take months or years even under bright sun. Once vegetation is established, sunlight does not reach the mesh. It is not uncommon to find nondegraded netting still in place several years after installation. This can be a problem if maintenance requires the use of mowers or ditch cleaning equipment. In addition, birds and small animals can become trapped in the netting.

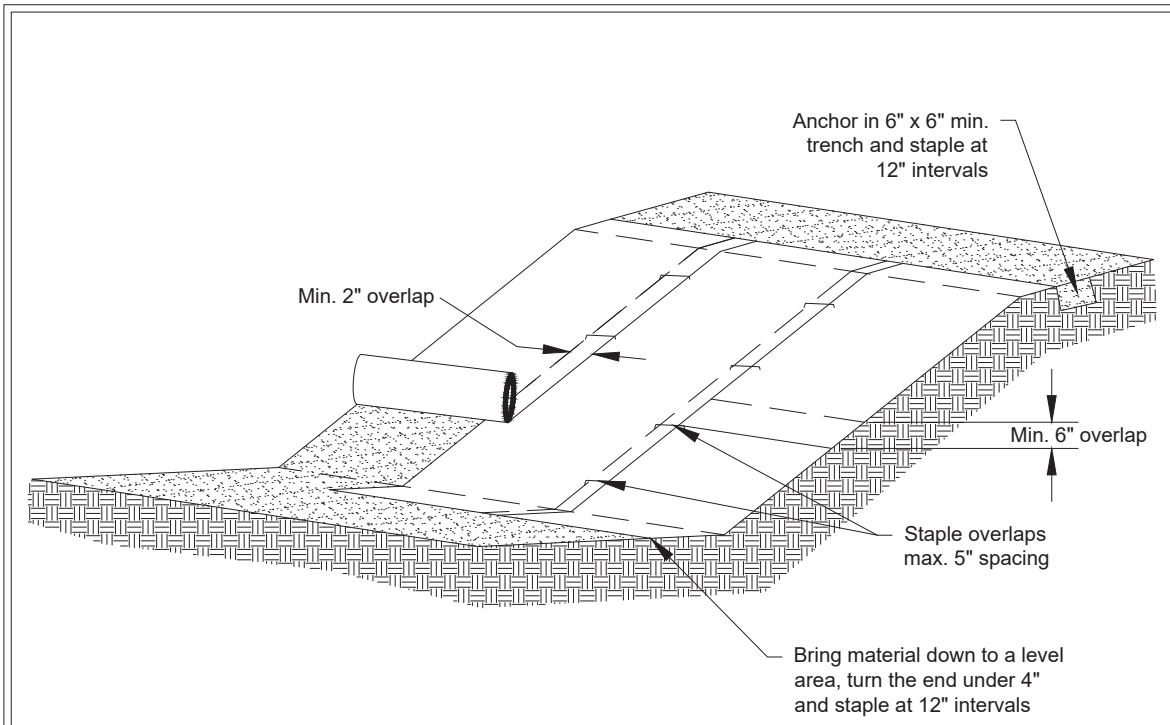
### ***Maintenance Standards***

- Maintain good contact with the ground. Erosion must not occur beneath the net or blanket.
- Repair and staple any areas of the net or blanket that are damaged or not in close contact with the ground.
- Fix and protect eroded areas if erosion occurs due to poorly controlled drainage.

**Figure 7.5: Channel Installation**



**Figure 7.6: Slope Installation**



Notes:

1. Slope surface shall be smooth before placement for proper soil contact.
2. Stapling pattern as per manufacturer's recommendations.
3. Do not stretch blankets/mattings tight - allow the rolls to mold to any irregularities.
4. For slopes less than 3H:1V, rolls may be placed in horizontal strips.
5. If there is a berm at the top of the slope, anchor upslope of the berm.
6. Lime, fertilize, and seed before installation. Planting of shrubs, trees, etc. should occur after installation.

NOT TO SCALE



## Slope Installation

Revised June 2016

Please see <http://www.ecy.wa.gov/copyright.html> for copyright notice including permissions, limitation of liability, and disclaimer.

## **BMP C123E: Plastic Covering**

### ***Purpose***

Plastic covering provides immediate, short-term erosion protection to slopes and disturbed areas.

### ***Conditions of Use***

Plastic covering may be used on disturbed areas that require cover measures for < 30 days, with the following exceptions:

- Plastic is particularly useful for protecting cut-and-fill slopes and stockpiles. However, the relatively rapid breakdown of most polyethylene sheeting makes it unsuitable for applications > 6 months.
- Due to rapid runoff caused by plastic covering, do not use this method upslope of areas that might be adversely impacted by concentrated runoff. Such areas include steep and/or unstable slopes.
- Plastic sheeting may result in increased runoff volumes and velocities, requiring additional on-site measures to counteract the increases. Creating a trough with wattles or other material can convey clean water away from these areas.
- To prevent undercutting, trench and backfill plastic covering that comes in a rolled form.
- Although the plastic material is inexpensive to purchase, the cost of installation, maintenance, removal, and disposal add to the total costs of this BMP.
- Whenever plastic is used to protect slopes, install water collection measures at the base of the slope. These measures include plastic-covered berms, channels, and pipes used to convey clean rainwater away from bare soil and disturbed areas. Do not mix clean runoff from a plastic covered slope with dirty runoff from a project.
- Other uses for plastic include the following:
  - Temporary ditch liner
  - Pond liner in temporary sediment pond
  - Liner for bermed temporary fuel storage area if plastic is not reactive to the type of fuel being stored
  - Emergency slope protection during heavy rains
  - Temporary drainpipe (“elephant trunk”) used to direct water

### ***Design and Installation Specifications***

- Plastic slope cover must be installed according to the following procedure:
  1. Run plastic up and down the slope, not across the slope.
  2. Plastic may be installed perpendicular to slope if the slope length < 10 feet.

3. Provide a minimum overlap of 8 inches at the seams.
  4. On long or wide slopes, or slopes subject to wind, tape all seams.
  5. Place plastic into a small (12-inch-wide by 6-inch-deep) slot trench at the top of the slope and backfill with soil to keep water from flowing underneath.
  6. Place sand-filled burlap or geotextile bags every 3 to 6 feet along seams and tie them together with twine to hold them in place.
  7. Inspect plastic for rips, tears, and open seams regularly and repair immediately. This prevents high-velocity runoff from contacting bare soil, which causes extreme erosion.
  8. Sandbags may be lowered into place tied to ropes. However, all sandbags must be staked in place.
- Plastic sheeting shall have a minimum thickness of 0.06 millimeters.
  - If erosion at the toe of a slope is likely, a gravel berm, riprap, or other suitable protection shall be installed at the toe of the slope in order to reduce the velocity of runoff.

### ***Maintenance Standards***

- Torn sheets must be replaced and open seams repaired.
- Completely remove and replace the plastic if it begins to deteriorate due to ultraviolet radiation.
- Completely remove plastic when no longer needed.
- Dispose of old tires used to weight down plastic sheeting appropriately.

### ***Approved as Functionally Equivalent***

The Washington State Department of Ecology (Ecology) has approved products as able to meet the requirements of this BMP. The products did not pass through the Technology Assessment Protocol–Ecology (TAPE) process. Local jurisdictions may choose not to accept these products or may require additional testing prior to consideration for local use. The products that Ecology has approved as functionally equivalent are available for review on Ecology’s Emerging Stormwater Treatment Technologies (TAPE) web page at the following address:

<https://ecology.wa.gov/Regulations-Permits/Guidance-technical-assistance/Stormwater-permittee-guidance-resources/Emerging-stormwater-treatment-technologies>

## **BMP C124E: Sodding**

### ***Purpose***

The purpose of sodding is to establish permanent turf for immediate erosion protection and to stabilize drainage paths where concentrated overland flow will occur.

### ***Conditions of Use***

Sodding may be used in the following areas:

- Disturbed areas that require short-term or long-term cover.
- Disturbed areas that require immediate vegetative cover.
- All waterways that require vegetative lining. Waterways may also be seeded rather than sodded and protected with a net or blanket.

### ***Design and Installation Specifications***

Sod shall be free of weeds, have a uniform thickness (approximately 1 inch), and have a dense root mat for mechanical strength.

The following steps are recommended for sod installation:

1. Shape and smooth the surface to final grade in accordance with the approved grading plan. Consider any areas (such as swales) that need to be overexcavated below design elevation to allow room for placing soil amendment and sod.
2. Amend 4 inches (minimum) of compost into the top 8 inches of the soil if the organic content of the soil is less than 10% or the permeability is less than 0.6 inches per hour. See the Washington State Department of Ecology's Compost web page for further information:  
<https://ecology.wa.gov/Waste-Toxics/Reducing-recycling-waste/Organic-materials/Managing-organics-compost>
3. Fertilize according to the sod supplier's recommendations.
4. Work lime and fertilizer 1 to 2 inches into the soil, and smooth the surface.
5. Lay strips of sod beginning at the lowest area to be sodded and perpendicular to the direction of water flow. Wedge strips securely into place. Square the ends of each strip to provide for a close, tight fit. Stagger joints  $\geq$  12 inches. Staple on slopes steeper than 3H:1V. Staple the upstream edge of each sod strip.
6. Roll the sodded area and irrigate.
7. When sodding is carried out in alternating strips or other patterns, seed the areas between the sod immediately after sodding.

### ***Maintenance Standards***

If the grass is unhealthy, the cause shall be determined and appropriate action taken to reestablish a healthy ground cover. If it is impossible to establish a healthy ground cover due to frequent saturation, instability, or some other cause, the sod shall be removed, and the area shall be seeded with an appropriate mix and protected with a net or blanket ([BMP C122E: Nets and Blankets](#)).

## **BMP C125E: Topsoiling/Composting**

### ***Purpose***

Topsoiling and composting provide a suitable growth medium for final site stabilization with vegetation. While not a permanent cover practice in itself, topsoiling is an integral component of providing permanent cover in areas with an unsuitable soil surface for plant growth. Use this BMP in

conjunction with other BMPs such as [BMP C120E: Temporary and Permanent Seeding](#), [BMP C121E: Mulching](#), or [BMP C124E: Sodding](#).

**Note:** BMP C125E: Topsoiling/Composting is functionally the same as [BMP F6.61: Amending Construction Site Soils](#).

Native soils and disturbed soils that have been organically amended not only retain much more stormwater but also serve as effective biofiltration for urban pollutants and, by supporting more vigorous plant growth, reduce the amount of water, fertilizer, and pesticides needed to support installed landscapes. Topsoil includes no subsoils, consisting of only material from the top several inches including organic debris.

### **Conditions of Use**

- Permanent landscaped areas shall contain healthy topsoil that reduces the need for fertilizers, improves overall topsoil quality, provides for better vegetative health and vitality, improves hydrologic characteristics, and reduces the need for irrigation.
- Leave native soils and the duff layer undisturbed to the maximum extent practicable. Stripping of existing, properly functioning soil system and vegetation for the purpose of topsoiling during construction is not acceptable. Preserve existing soil systems in undisturbed and uncompacted conditions if functioning properly.
- Areas that already have good topsoil, such as undisturbed areas, do not require soil amendments.
- Restore, to the maximum extent practical, native soils disturbed during clearing and grading to a condition equal to or better than the original site condition's moisture-holding capacity. Use on-site native topsoil, incorporate amendments into on-site soil, or import blended topsoil to meet this requirement.
- Topsoiling is a required procedure when establishing vegetation on shallow soils and soils of critically low pH (high acid) levels.
- Beware of where the topsoil comes from and what vegetation was on-site before disturbance. Invasive plant seeds may be included and could cause problems for establishing native plants, landscaped areas, or grasses.
- Topsoil from the site will contain mycorrhizal bacteria that are necessary for healthy root growth and nutrient transfer. These native mycorrhizae are acclimated to the site and will provide optimum conditions for establishing grasses. Use commercially available mycorrhizae products when using off-site topsoil.

### **Design and Installation Specifications**

If topsoiling is to be performed, the following guidelines should be considered:

- Maximize the depth of the topsoil wherever possible to provide the maximum possible infiltration capacity and beneficial growth medium. Topsoil shall have the following:
  - A minimum depth of 8 inches.
  - A target organic content of 6% to 8% dry weight for all nonturf planting areas and 3% to



- 5% organic matter content for turf areas. Imported topsoil mixes should contain 35% to 40% compost by volume for nonturf planting areas and 20% to 25% compost by volume for turf areas.
- A pH between 6.0 and 8.0 or as specified for particular plant choices.
  - If blended topsoil is imported, fines should be limited to 25% passing through a No. 200 sieve.
- Mulch planting beds with 2 inches of organic material.
  - Accomplish the required organic content, depth, and pH by returning native topsoil to the site, importing topsoil of sufficient organic content, and/or incorporating organic amendments. When incorporating amendments to meet the organic content requirement, use compost that meets the compost specification for bioretention (see [Chapter 5 - Runoff Treatment BMP Design](#)), with the exception that the compost may have up to 35% biosolids or manure. The compost material should be mature and derived from organic waste materials including plant debris, biosolids, or wood wastes that meet the functional requirements and intent of the organic soil amendment specification.
  - Organic amendments should be incorporated to a minimum depth of 8 inches except where tree roots or other natural features limit the depth of incorporation. Subsoils at a depth > 12 inches should be scarified  $\geq 2$  inches to avoid stratified layers, where feasible. The decision to either layer topsoil over a subgrade or incorporate topsoil into the underlying layer may vary depending on the planting specified.
  - The final composition and construction of the soil system will result in a natural selection or favoring of certain plant species over time. For example, incorporation of topsoil may favor grasses, while layering with mildly acidic, high-carbon amendments may favor more woody vegetation.
  - Allow sufficient time in scheduling for topsoil spreading prior to seeding, sodding, or planting.
  - Take care when applying topsoil to subsoils with contrasting textures. Sandy topsoil over clayey subsoil is a particularly poor combination, as water creeps along the junction between the soil layers and causes the topsoil to slough. If topsoil and subsoil are not properly bonded, water will not infiltrate the soil profile evenly and it will be difficult to establish vegetation. The best method to prevent a lack of bonding is to actually work the topsoil into the layer below for a depth  $\geq 6$  inches.
  - Field exploration of the site shall be made to determine if there is surface soil of sufficient quantity and quality to justify stripping. Topsoil shall be friable and loamy (loam, sandy loam, silt loam, sandy clay loam, or clay loam). Avoid areas of natural ground water recharge.
  - Stripping shall be confined to the immediate construction area. A 4- to 6-inch stripping depth is common, but depth may vary depending on the particular soil. All surface runoff control structures shall be in place prior to stripping.
  - Ripping or restructuring the subgrade may also provide additional benefits in terms of the overall infiltration and interflow dynamics of the soil system.
  - Do not place topsoil while in a frozen or muddy condition, when the subgrade is excessively

wet, or when conditions exist that may otherwise be detrimental to proper grading or proposed sodding or seeding.

- In any areas requiring grading, remove and stockpile the duff layer and topsoil on-site in a designated, controlled area, not adjacent to public resources and critical areas. Reapply stockpiled topsoil to other portions of the site where feasible.
- Locate the topsoil stockpile so that it meets specifications and does not interfere with work on the site. It may be possible to locate more than one pile in proximity to areas where topsoil will be used.
- Stockpiling of topsoil shall occur in the following manner:
  - Side slopes of the stockpile shall not > 2H:1V.
  - Between October 1 and June 30:
    - Install an interceptor dike with gravel outlet and silt fence to surround all topsoil stockpiles.
    - Within 7 days, complete erosion control seeding or cover stockpiles with clear plastic or other mulching materials.
  - Between July 1 and September 30:
    - Install an interceptor dike with gravel outlet and silt fence to surround all topsoil stockpiles if the stockpile will remain in place for a longer period of time than active construction grading.
    - Within 30 days, complete erosion control seeding or cover stockpiles with clear plastic or other mulching materials.
- Previously established grades on the areas to be topsoiled shall be maintained according to the approved plan.
- When native topsoil is to be stockpiled and reused, the following should apply to ensure that the mycorrhizal bacteria, earthworms, and other beneficial organisms will not be destroyed:
  1. Reinstall topsoil within 4 to 6 weeks.
  2. Do not allow the topsoil to become saturated with water.
  3. Do not use plastic covering.

### ***Maintenance Standards***

- Inspect stockpiles regularly, especially after large storm events. Stabilize any areas that have eroded.
- Establish soil quality and depth toward the end of construction and once established, protect from compaction, such as from large machinery use, and from erosion.
- Plant and mulch soil after installation.
- Leave plant debris or its equivalent on the soil surface to replenish organic matter.

- Reduce and adjust, where possible, the use of irrigation, fertilizers, herbicides and pesticides, rather than continuing to implement formerly established practices.

## **BMP C126E: Polyacrylamide for Soil Erosion Protection**

### ***Purpose***

Polyacrylamide (PAM) is used on construction sites to prevent soil erosion. Applying PAM to bare soil in advance of a rain event significantly reduces erosion and controls sediment in two ways. First, PAM increases the soil's available pore volume, thus increasing infiltration and reducing the quantity of stormwater runoff. Second, it increases flocculation of suspended particles and aids in their deposition, thus reducing stormwater runoff turbidity and improving water quality.

### ***Conditions of Use***

PAM shall not be directly applied to water or allowed to enter a water body.

In areas that drain to a sediment pond, PAM can be applied to bare soil under the following conditions:

- During rough grading operations.
- In staging areas.
- In balanced cut-and-fill earthwork.
- On haul roads prior to placement of crushed rock surfacing.
- On compacted soil road base.
- At stockpiles.
- After final grade and before paving or final seeding and planting.
- At pit sites.
- At sites having a winter shutdown. In the case of winter shutdown or where soil will remain unworked for several months, PAM should be used together with mulch.

### ***Design and Installation Specifications***

- Do not use PAM on a slope that flows directly into a stream or wetland. The stormwater runoff shall pass through a sediment control BMP prior to discharging to receiving waters.
- Do not add PAM to water discharging from the site.
- When the total contributing area is  $\geq 5$  acres, PAM-treated areas shall drain to a sediment pond.
- Areas  $< 5$  acres shall drain to sediment control BMPs, such as a minimum of three check dams per acre. The total number of check dams used shall be maximized to achieve the greatest amount of settlement of sediment prior to discharging from the site. Each check dam shall be spaced evenly in the drainage channel through which stormwater flows are

discharged off-site.

- Maximize the use of silt fence to limit the discharges of sediment from the site.
- All areas not being actively worked shall be covered and protected from rainfall. PAM shall not be the only cover BMP used.
- PAM can be applied to wet soil, but dry soil is preferred due to less sediment loss.
- PAM will work when applied to saturated soil, but is not as effective as applications to dry or damp soil.

### **Preferred Application Method**

PAM may be applied in dissolved form with water, or it may be applied in dry, granular or powdered form. The preferred application method is the dissolved form.

PAM is to be applied at a maximum rate of 2/3 pound PAM per 1,000 gallons water (80 milligrams per liter [mg/L]) per 1 acre of bare soil. See [Table 7.15: Polyacrylamide and Water Application Rates](#) to determine the PAM and water application rate for a disturbed soil area. Higher concentrations of PAM do not provide any additional effectiveness.

**Table 7.15: Polyacrylamide and Water Application Rates**

<b>Disturbed Area (acres)</b>	<b>Polyacrylamide (pounds)</b>	<b>Water (gallons)</b>
0.50	0.33	500
1.00	0.66	1,000
1.50	1.00	1,500
2.00	1.32	2,000
2.50	1.65	2,500
3.00	2.00	3,000
3.50	2.33	3,500
4.00	2.65	4,000
4.50	3.00	4,500
5.00	3.33	5,000

Implement the following steps to apply PAM using the preferred method:

1. Premeasure the area where PAM is to be applied and calculate the amount of product and water necessary to provide coverage at the specified application rate (0.5 pounds PAM/1,000 gallons/acre).
2. PAM has infinite solubility in water, but dissolves very slowly. Dissolve premeasured dry granular PAM with a known quantity of clean water in a bucket several hours or overnight.

Mechanical mixing will help dissolve the PAM. Always add PAM to water—not water to PAM.

3. Prefill the water truck about one-eighth full with water. The water does not have to be potable, but it must have relatively low turbidity— $\leq 20$  nephelometric turbidity units (NTUs).
4. Add the PAM/water mixture to the truck.
5. Completely fill the water truck to the specified volume.
6. Spray the PAM/water mixture onto dry soil, until the soil surface is uniformly and completely wetted.

### **Alternative Application Method**

PAM may also be applied as a powder at the rate of 5 pounds per acre. This must be applied on a day that is dry. For areas  $< 5$  to 10 acres, a handheld “organ grinder” fertilizer spreader set to the smallest setting will work. Tractor-mounted spreaders will work for larger areas.

The following shall be used for application of PAM:

- Powdered PAM shall be used in conjunction with other BMPs and not in place of other BMPs.
- Keep the granular PAM supply out of the sun. Granular PAM loses its effectiveness in 3 months after exposure to sunlight and air.
- Proper application and reapplication plans are necessary to ensure total effectiveness of PAM usage.

### **Safety and Toxicity**

- PAM, combined with water, is very slippery and can be a safety hazard. Care must be taken to prevent spills of PAM powder onto paved surfaces. During an application of PAM, prevent overspray from reaching pavement to prevent slippery pavement. If PAM powder gets on skin or clothing, wipe it off with a rough towel rather than washing with water. Washing with water will make cleanup messier and take longer.
- Some PAMs are more toxic and carcinogenic than others. Only the most environmentally safe PAM products should be used.
- The specific PAM copolymer formulation must be anionic. Cationic PAM shall not be used in any application because of known aquatic toxicity problems. Use only the highest drinking water grade PAM, certified for compliance with NSF International (NSF)/American National Standards Institute (ANSI) Standard 60 for drinking water treatment, for soil applications. Recent media attention and high interest in PAM has resulted in some entrepreneurial exploitation of the term “polymer.” All PAMs are polymers, but not all polymers are PAMs, and not all PAM products comply with ANSI/NSF Standard 60. PAM use shall be reviewed and approved by the local jurisdiction.
- PAM designated for these uses should be “water soluble” or “linear” or “non-cross-linked.” Cross-linked or water-absorbent PAMs, polymerized in highly acidic ( $\text{pH} < 2$ ) conditions, are used to maintain soil moisture content.

- The PAM anionic charge density may vary from 2% to 30%; a value of 18% is typical. Studies conducted by the U.S. Department of Agriculture (USDA), Agricultural Research Service demonstrated that soil stabilization was optimized by using very high molecular weight (12 to 15 milligrams (mg)/mole), highly anionic (> 20% hydrolysis) PAM.
- PAM tackifiers are available and being used in place of guar and alpha plantago. Typically, PAM tackifiers should be used at a rate of no more than 0.5 to 1 pound per 1,000 gallons of water in a hydromulch machine. Some tackifier product instructions say to use at a rate of 3 to 5 pounds per acre, which can be too much. In addition, pump problems can occur at higher rates due to increased viscosity.

### **Maintenance Standards**

- PAM may be reapplied on actively worked areas after a 48-hour period.
- Reapplication is not required unless PAM-treated soil is disturbed or unless turbidity levels show the need for an additional application. If PAM-treated soil is left undisturbed, a reapplication may be necessary after 2 months. More PAM applications may be required for steep slopes, silty and clayey soils (USDA Classification Type “C” and “D” soils), long grades, and high precipitation areas. When PAM is applied first to bare soil and then covered with straw, a reapplication may not be necessary for several months.
- Loss of sediment and PAM may be a basis for penalties per [RCW 90.48.080](#).

## **BMP C130E: Surface Roughening**

### **Purpose**

Surface roughening aids in the establishment of vegetative cover, reduces runoff velocity, increases infiltration, and provides for sediment trapping through the provision of a rough soil surface. Horizontal depressions are created by operating a tiller or other suitable equipment on the contour or by leaving slopes in a roughened condition by not fine grading them.

**For more information:** Use this BMP in conjunction with other BMPs such as [BMP C120E: Temporary and Permanent Seeding](#), [BMP C121E: Mulching](#), or [BMP C124E: Sodding](#).

### **Conditions for Use**

- All slopes > 3H:1V and > 5 vertical feet require surface roughening to a depth of 2 to 4 inches prior to seeding.
- Areas that will not be stabilized immediately may be roughened to reduce runoff velocity until seeding takes place.
- Slopes with a stable rock face do not require roughening.
- Slopes where mowing is planned should not be excessively roughened.

### **Design and Installation Specifications**

There are different methods for achieving a roughened soil surface on a slope, and the selection of an appropriate method depends on the type of slope. Roughening methods include stair-step

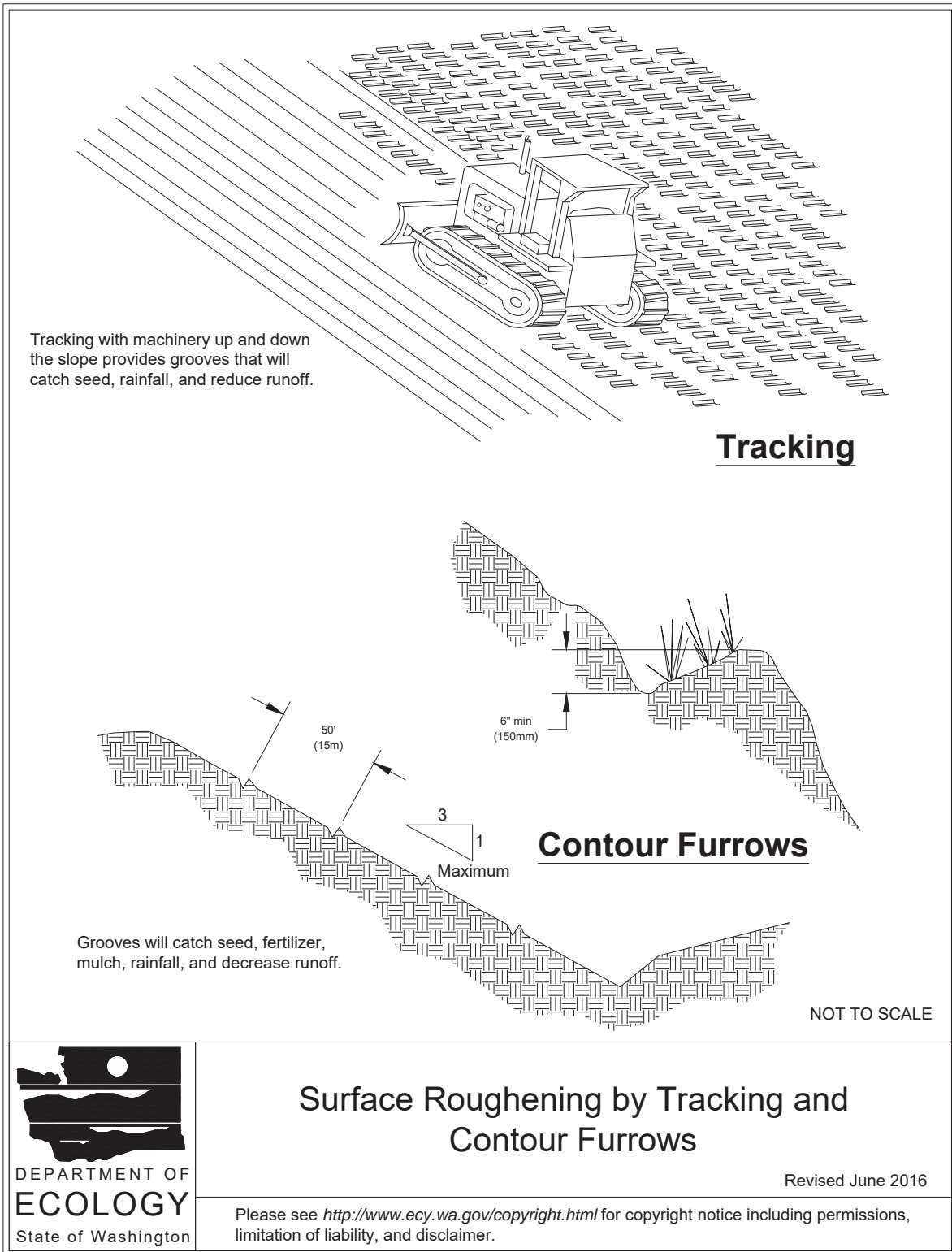
grading, grooving, contour furrows, and tracking. See [Figure 7.7: Surface Roughening by Tracking and Contour Furrows](#) for tracking and contour furrows. Factors to be considered in choosing a roughening method are slope steepness, mowing requirements, and whether the slope is formed by cutting or filling.

- Disturbed areas that will not require mowing may be stair-step graded, grooved, or left rough after filling.
- Stair-step grading is particularly appropriate in soils containing large amounts of soft rock. Each “step” catches material that sloughs from above, and provides a level site where vegetation can become established. Stairs should be wide enough to work with standard earth moving equipment. Stair steps must be on contour or gullies will form on the slope.
- Areas that will be mowed (these areas should have slopes less steep than 3:1) may have small furrows left by disking, harrowing, raking, or seed-planting machinery operated on the contour.
- Graded areas with slopes  $> 3H:1V$  but  $< 2H:1V$  should be roughened before seeding. This can be accomplished in a variety of ways, including “track walking,” or driving a crawler tractor up and down the slope, leaving a pattern of cleat imprints parallel to slope contours.
- Tracking is done by operating equipment up and down the slope to leave horizontal depressions in the soil.

### ***Maintenance Standards***

- Areas that are surface roughened should be seeded as quickly as possible.
- Regular inspections should be made of the area. If rills appear, they should be re-roughened and reseeded immediately.

**Figure 7.7: Surface Roughening by Tracking and Contour Furrows**





## BMP C131E: Gradient Terraces

### Purpose

Gradient terraces reduce erosion damage by intercepting surface runoff and conveying it to a stable outlet at a nonerosive velocity.

### Conditions for Use

Gradient terraces are normally limited to bare land having a water erosion problem. They should not be constructed on deep sands or on soils that are too stony, steep, or shallow to permit practical and economical installation and maintenance. Gradient terraces may only be used where suitable outlets are or will be made available. See [Figure 7.8: Gradient Terraces](#) for gradient terraces.

### Design and Installation Specifications

- The maximum spacing of gradient terraces should be determined by the following method:

#### Equation 7.1: Gradient Terrace Spacing

$$VI = (0.8 * s) + y$$

where:

VI = vertical interval (feet)

s = land rise per 100 feet (feet)

y = a soil and cover variable with values from 1.0 to 4.0

Values of “y” are influenced by soil erodibility and cover practices. The lower values are applicable to erosive soils where little to no residue is left on the surface. The higher value is applicable only to erosion-resistant soils where a large amount of residue (1.5 tons of straw per acre equivalent) is on the surface.

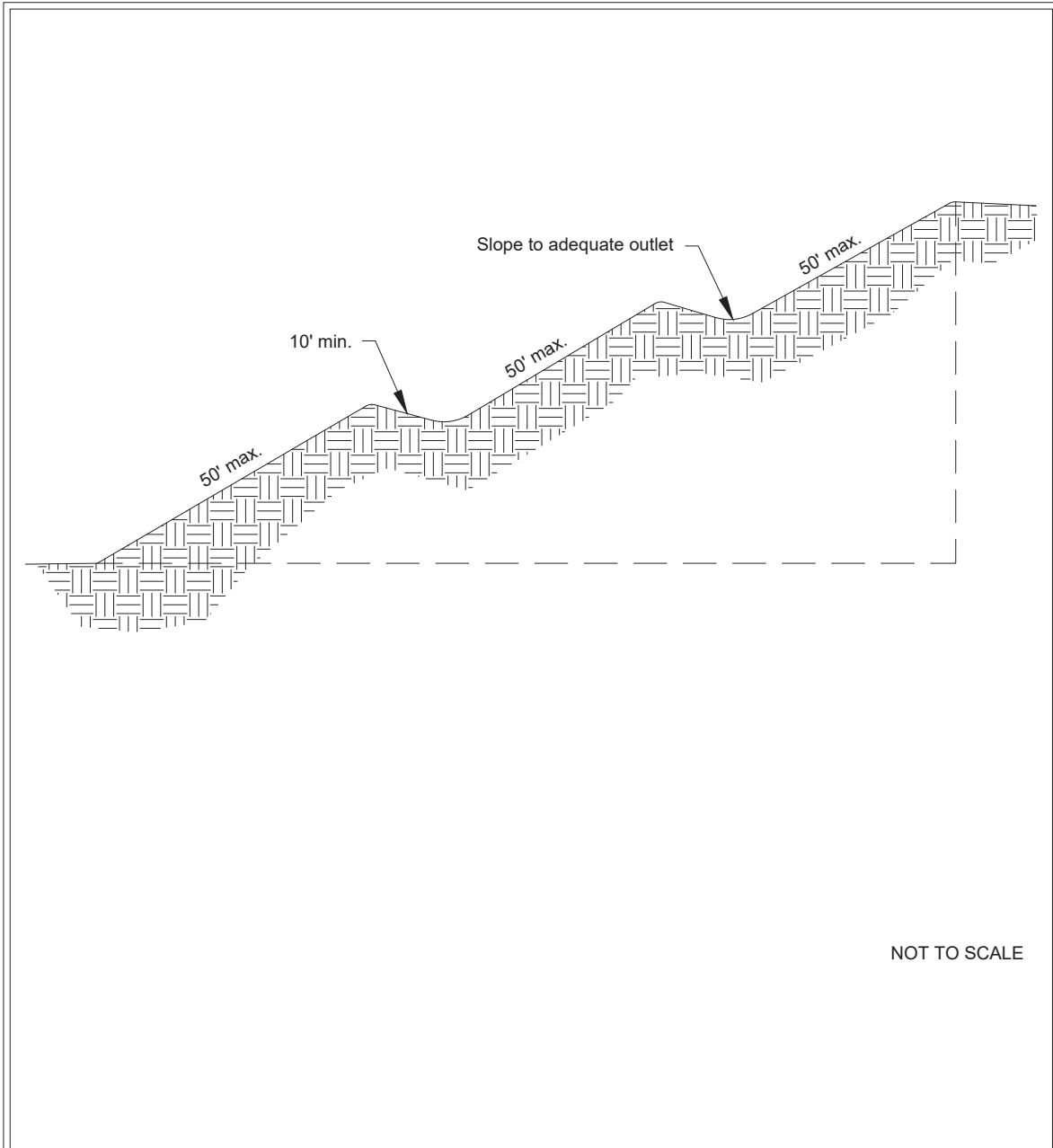
- The minimum constructed cross section should meet the design dimensions.
- The top of the constructed ridge should not be lower at any point than the design elevation plus the specified overfill for settlement. The opening at the outlet end of the terrace should have a cross section equal to that specified for the terrace channel.
- Channel grades may be either uniform or variable with a maximum grade of 0.6 feet per 100 feet length (0.6%). For short distances, terrace grades may be increased to improve alignment. The channel velocity should not exceed that which is nonerosive for the soil type.
- All gradient terraces should have adequate outlets. Such an outlet may be a grassed waterway, vegetated area, or tile outlet. In all cases the outlet must convey runoff from the terrace or terrace system to a point where the outflow will not cause damage. Vegetative cover and energy dissipaters should be used in the outlet channel.
- The design elevation of the water surface of the terrace should not be lower than the design elevation of the water surface in the outlet at their junction, when both are operating at design flow.

- Vertical spacing determined by the above methods may be increased as much as 0.5 feet or 10%, whichever is greater, to provide better alignment or location, to avoid obstacles, to adjust for equipment size, or to reach a satisfactory outlet. The contributing area above the top should not exceed the area that would be drained by a terrace with normal spacing.
- The terrace should have enough capacity to handle the peak runoff expected from a 2-year, 24-hour design storm without overtopping.
- The terrace cross section should be proportioned to fit the land slope.
- The ridge height should include a reasonable settlement factor.
- The ridge should have a minimum top width of 3 feet at the design height.
- The minimum cross-sectional area of the terrace channel should be 8 square feet (sf) for land slopes of 5% or less, 7 sf for slopes from 5% to 8%, and 6 sf for slopes steeper than 8%. The terrace can be constructed wide enough to be maintained using a small vehicle.

### ***Maintenance Standards***

Maintenance should be performed as needed. Terraces should be inspected regularly, at least once per year and after large storm events.

**Figure 7.8: Gradient Terraces**



## Gradient Terraces

Revised June 2016

Please see <http://www.ecy.wa.gov/copyright.html> for copyright notice including permissions, limitation of liability, and disclaimer.

## **BMP C140E: Dust Control**

### ***Purpose***

Dust control prevents wind transport of dust from disturbed soil surfaces onto roadways, into drainage systems, and into receiving waters. Wind erosion is a significant cause of soil movement from construction sites in eastern Washington. Although wind erosion can contribute to water quality impacts, dust control is regulated in some areas of eastern Washington primarily through local air quality authorities. Where such an entity exists, contact the local air quality authority for appropriate and required BMPs for dust control to implement at your project site.

### ***Conditions for Use***

Use dust control in areas (including roadways) subject to surface and air movement of dust where on-site or off-site impacts on roadways, drainage systems, or receiving waters are likely.

### ***Design and Installation Specifications***

- Vegetate or mulch areas that will not receive vehicle traffic. In areas where planting, mulching, or paving is impractical, apply gravel or landscaping rock.
- Limit dust generation by clearing only those areas where immediate activity will take place, leaving the remaining area(s) in the original condition, if stable. Maintain the original ground cover as long as practical.
- Construct natural or artificial windbreaks or windscreens. These may be designed as enclosures for small dust sources.
- Sprinkle the site with water until the surface is wet. Repeat as needed. To prevent carryout of mud onto the street, see [BMP C105E: Stabilized Construction Access](#) and [BMP C106E: Wheel Wash](#).
- Irrigation water can be used for dust control. Irrigation systems should be installed as a first step on sites where dust control is a concern.
- Spray exposed soil areas with a dust palliative, following the manufacturer's instructions and cautions regarding handling and application. Used oil is prohibited from use as a dust suppressant. Local jurisdictions may approve other dust palliatives such as calcium chloride or polyacrylamide (PAM).
- PAM ([BMP C126E: Polyacrylamide for Soil Erosion Protection](#)) added to water at a rate of 0.5 pounds per 1,000 gallons of water per acre and applied from a water truck is more effective than water alone. This is due to the increased infiltration of water into the soil and reduced evaporation. In addition, small soil particles are bonded together and are not as easily transported by wind. Adding PAM may reduce the quantity of water needed for dust control, especially in eastern Washington. PAM should not be directly applied to water or allowed to enter a water body.
- Contact your local air pollution control authority for guidance and training on other dust control measures. Compliance with the local air pollution control authority constitutes compliance with this BMP. See the following website for more information:

<https://ecology.wa.gov/About-us/Our-role-in-the-community/Partnerships-committees/Clean-air-agencies>

- Use vacuum street sweepers.
- Remove mud and other dirt promptly so it does not dry and then turn into dust.

Techniques that can be used for unpaved roads and lots include the following:

- Reduce speed limits. High vehicle speed increases the amount of dust stirred up from unpaved roads and lots.
- Upgrade the road surface strength by improving particle size, shape, and mineral types that make up the surface and base materials.
- Add surface gravel to reduce the source of dust emission. Limit the amount of fine particles < 0.075 millimeters to 10% to 20%.
- Use geotextile fabrics to increase the strength of new roads or roads undergoing reconstruction.
- Encourage the use of alternate, paved routes, if available.
- Apply chemical dust suppressants using the admix method, blending the product with the top few inches of surface material. Suppressants may also be applied as surface treatments.
- Limit dust-generating work on windy days.
- Pave unpaved permanent roads and other trafficked areas.

## ***Maintenance Standards***

Respray area as necessary to keep dust to a minimum.

## **BMP C150E: Materials on Hand**

### ***Purpose***

Quantities of erosion prevention and sediment control materials can be kept on the project site at all times to be used for emergency situations such as unexpected heavy rains. Having these materials on-site reduces the time needed to replace existing or implement new BMPs when inspections indicate that existing BMPs are not meeting the Construction Stormwater Pollution Prevention Plan (SWPPP) requirements. In addition, contractors can save money by buying some materials in bulk and storing them at their office or yard.

### ***Conditions for Use***

- Construction projects of any size or type can benefit from having materials on hand. A small commercial development project could have a roll of plastic and some gravel available for immediate protection of bare soil and temporary berm construction. A large earthwork project, such as highway construction, might have several tons of straw, several rolls of plastic, flexible pipe, sandbags, geotextile fabric and steel “T” posts.

- Materials should be stockpiled and readily available before any site clearing, grubbing, or earthwork begins. A large contractor or developer could keep a stockpile of materials that are available to be used on several projects.
- If storage space at the project site is at a premium, the contractor could maintain the materials at their office or yard. The office or yard must be less than an hour from the project site.

### ***Design and Installation Specifications***

Depending on the project type, size, complexity, and length, the materials and quantities will vary. A good minimum list of items that will cover numerous situations includes the following:

- Clear plastic, 6 mil
- Drainpipe, 6- or 8-inch-diameter
- Sandbags, filled
- Straw bales for mulching
- Quarry spalls
- Washed gravel
- Geotextile fabric
- Catch basin inserts
- Steel “T” posts
- Silt fence material
- Straw wattles

### ***Maintenance Standards***

- All materials with the exception of the quarry spalls, steel “T” posts, and gravel should be kept covered and out of both sun and rain.
- Restock materials as needed.

## **BMP C151E: Concrete Handling**

### ***Purpose***

Concrete work can generate process water and slurry that contain fine particles and high pH, both of which can violate water quality standards in the receiving water. Concrete spillage or concrete discharge to waters of the State is prohibited. Use this BMP to minimize and eliminate concrete, concrete process water, and concrete slurry from entering waters of the State.

## **Conditions of Use**

Any time concrete is used, utilize these management practices. Concrete construction project components include, but are not limited to:

- Curbs
- Sidewalks
- Roads
- Bridges
- Foundations
- Floors
- Runways

Disposal options for concrete, in order of preference are:

1. Off-site disposal
2. Concrete wash-out areas (see [BMP C154E: Concrete Washout Area](#))
3. De minimus washout to formed areas awaiting concrete

## **Design and Installation Specifications**

- Wash concrete truck drums at an approved off-site location or in designated concrete washout areas only. Do not wash out concrete trucks onto the ground (including formed areas awaiting concrete), or into storm drains, open ditches, streets, or streams. Refer to [BMP C154E: Concrete Washout Area](#) for information on concrete washout areas.
  - Return unused concrete remaining in the truck and pump to the originating batch plant for recycling. Do not dump excess concrete on site, except in designated concrete washout areas as allowed in [BMP C154E: Concrete Washout Area](#).
- Wash small concrete handling equipment (e.g. hand tools, screeds, shovels, rakes, floats, trowels, and wheelbarrows) into designated concrete washout areas or into formed areas awaiting concrete pour.
- At no time shall concrete be washed off into the footprint of an area where an infiltration feature will be installed.
- Wash equipment difficult to move, such as concrete paving machines, in areas that do not directly drain to natural or constructed stormwater conveyance or potential infiltration areas.
- Do not allow washwater from areas, such as concrete aggregate driveways, to drain directly (without detention or treatment) to natural or constructed stormwater conveyances.
- Contain washwater and leftover product in a lined container when no designated concrete washout areas (or formed areas, allowed as described above) are available. Dispose of contained concrete and concrete washwater (process water) properly.

- Always use forms or solid barriers for concrete pours, such as pilings, within 15-feet of surface waters.
- Refer to [BMP C252E: Treating and Disposing of High pH Water](#) for pH adjustment requirements.
- Refer to the Construction Stormwater General Permit (CSWGP) for pH monitoring requirements if the project involves one of the following activities:
  - Significant concrete work (as defined in the CSWGP).
  - The use of soils amended with (but not limited to) Portland cement-treated base, cement kiln dust or fly ash.
  - Discharging stormwater to segments of water bodies on the 303(d) list (Category 5) for high pH.

### ***Maintenance Standards***

Check containers for holes in the liner daily during concrete pours and repair the same day.

## **BMP C152E: Sawcutting and Surfacing Pollution Prevention**

### ***Purpose***

Sawcutting and surfacing operations generate slurry and process water that contain fine particles and have a high pH (concrete cutting), both of which can violate the water quality standards in the receiving water. Concrete spillage or concrete discharge to surface waters of the state is prohibited. Use this BMP to minimize and prevent process water and slurry created by sawcutting or surfacing from entering waters of the state.

### ***Conditions for Use***

Anytime sawcutting or surfacing operations take place, these management practices should be used. Sawcutting and surfacing operations include, but are not limited to, the following:

- Sawing
- Coring
- Grinding
- Roughening
- Hydrodemolition
- Bridge and road surfacing

### ***Design and Installation Specifications***

- Vacuum slurry and cuttings during cutting and surfacing operations.
- Slurry and cuttings should not remain on permanent concrete or asphalt pavement overnight.



- Slurry and cuttings should not drain to any natural or constructed drainage system. This may require temporarily blocking catch basins.
- Dispose of collected slurry and cuttings in a manner that does not violate ground water or surface water quality standards.
- Do not allow process water generated during hydrodemolition, surface roughening or similar operations to drain to any natural or constructed drainage system. Dispose of process water in a manner that does not violate ground water or surface water quality standards.
- Handle and dispose of cleaning waste material and demolition debris in a manner that does not cause contamination of water. Dispose of sweeping material from a pickup sweeper at an appropriate disposal site.

### ***Maintenance Standards***

Continually monitor operations to determine whether slurry, cuttings, or process water could enter waters of the state. If inspections show that a violation of water quality standards could occur, stop operations and immediately implement preventive measures such as berms, barriers, secondary containment, and/or vacuum trucks.

## **BMP C153E: Material Delivery, Storage, and Containment**

### ***Purpose***

Prevent, reduce, or eliminate the discharge of pollutants to the drainage system or receiving waters from material delivery and storage. Minimize the storage of hazardous materials on-site, store materials in a designated area, and install secondary containment.

### ***Conditions of Use***

These procedures are suitable for use at all construction sites with delivery and storage of the following materials:

- Petroleum products such as fuel, oil and grease
- Soil stabilizers and binders (e.g., polyacrylamide)
- Fertilizers, pesticides, and herbicides
- Detergents
- Asphalt and concrete compounds
- Hazardous chemicals such as acids, lime, adhesives, paints, solvents, and curing compounds
- Any other material that may be detrimental if released to the environment

### ***Design and Installation Specifications***

The following steps should be taken to minimize risk:

- Temporary storage area should be located away from vehicle traffic, near the construction entrance(s), and away from receiving waters or storm drains.
- Safety Data Sheets should be supplied for all stored materials stored. Chemicals should be kept in their original labeled containers.
- Hazardous material storage on-site should be minimized.
- Hazardous materials should be handled as infrequently as possible.
- During the wet weather season (October 1 through June 30), consider storing materials in a covered area.
- Materials should be stored in secondary containments, such as earthen dike, horse trough, or even a children's wading pool for nonreactive materials such as detergents, oil, grease, and paints. Small amounts of material may be secondarily contained in "bus boy" trays or concrete mixing trays.
- Do not store chemicals, drums, or bagged materials directly on the ground. Place these items on a pallet and within secondary containment.
- If drums must be kept uncovered, store them at a slight angle to reduce ponding of rainwater on the lids to reduce corrosion. Domed plastic covers are inexpensive and snap to the top of drums, preventing water from collecting.

### **Material Storage Areas and Secondary Containment Practices**

- Liquids, petroleum products, and substances listed in [40 CFR Part 110](#), [40 CFR Part 117](#), or [40 CFR Part 302](#) shall be stored in approved containers and drums and shall not be overfilled. Containers and drums shall be stored in temporary secondary containment facilities.
- Temporary secondary containment facilities shall provide for a spill containment volume able to contain 10% of the total enclosed container volume of all containers, or 110% of the capacity of the largest container within its boundary, whichever is greater.
- Secondary containment facilities shall be impervious to the materials stored therein for a minimum contact time of 72 hours.
- Secondary containment facilities shall be maintained free of accumulated rainwater and spills. In the event of spills or leaks, accumulated rainwater and spills shall be collected and placed into drums. These liquids shall be handled as hazardous waste unless testing determines them to be nonhazardous.
- Sufficient separation should be provided between stored containers to allow spill cleanup and emergency response access.
- During the wet weather season (October 1 through June 30), each secondary containment facility shall be covered during nonworking days.
- At all times, each secondary containment facility shall be covered prior to and during rain events.
- Keep material storage areas clean, organized, and equipped with an ample supply of

appropriate spill cleanup material (spill kit).

- The spill kit should include, at a minimum, the following items:
  - One water-resistant nylon bag
  - Three oil-absorbent socks (3 inches by 4 feet)
  - Two oil-absorbent socks (3 inches by 10 feet)
  - Twelve oil-absorbent pads (17 by 19 inches)
  - One pair of splash-resistant goggles
  - Three pairs of nitrile gloves
  - Ten disposable bags with ties
  - Instructions

## **BMP C154E: Concrete Washout Area**

### ***Purpose***

Prevent or reduce the discharge of pollutants from concrete waste to stormwater by conducting washout off-site, or performing on-site washout in a designated area.

### ***Conditions of Use***

Concrete washout areas are implemented on construction projects where:

- Concrete is used as a construction material
- It is not possible to dispose of all concrete wastewater and washout off-site (ready mix plant, etc.).
- Concrete truck drums are washed on-site.

Note that auxiliary concrete truck components (e.g. chutes and hoses) and small concrete handling equipment (e.g. hand tools, screeds, shovels, rakes, floats, trowels, and wheelbarrows) may be washed into formed areas awaiting concrete pour.

At no time shall concrete be washed off into the footprint of an area where an infiltration feature will be installed.

### ***Design and Installation Specifications***

#### **Implementation**

- Perform washout of concrete truck drums at an approved off-site location or in designated concrete washout areas only.
- Do not wash out concrete onto non-formed areas, or into storm drains, open ditches, streets,

or streams.

- Wash equipment difficult to move, such as concrete paving machines, in areas that do not directly drain to natural or constructed stormwater conveyance or potential infiltration areas.
- Do not allow excess concrete to be dumped on-site, except in designated concrete washout areas as allowed above.
- Concrete washout areas may be prefabricated concrete washout containers, or self-installed structures (above-grade or below-grade).
- Prefabricated containers are most resistant to damage and protect against spills and leaks. Companies may offer delivery service and provide regular maintenance and disposal of solid and liquid waste.
- If self-installed concrete washout areas are used, below-grade structures are preferred over above-grade structures because they are less prone to spills and leaks.
- Self-installed above-grade structures should only be used if excavation is not practical.
- Concrete washout areas shall be constructed and maintained in sufficient quantity and size to contain all liquid and concrete waste generated by washout operations.

### **Education**

- Discuss the concrete management techniques described in this BMP with the ready-mix concrete supplier before any deliveries are made.
- Educate employees and subcontractors on the concrete waste management techniques described in this BMP.
- Arrange for the contractor's superintendent or Certified Erosion and Sediment Control Lead (CESCL) to oversee and enforce concrete waste management procedures.
- A sign should be installed adjacent to each concrete washout area to inform concrete equipment operators to utilize the proper facilities.

### **Contracts**

Incorporate requirements for concrete waste management into concrete supplier and subcontractor agreements.

### **Location and Placement**

- Locate concrete washout areas at least 50 feet from sensitive areas such as storm drains, open ditches, water bodies, or wetlands.
- Allow convenient access to the concrete washout area for concrete trucks, preferably near the area where the concrete is being poured.
- If trucks need to leave a paved area to access the concrete washout area, prevent track-out with a pad of rock or quarry spalls (see [BMP C105E: Stabilized Construction Access](#)). These

areas should be far enough away from other construction traffic to reduce the likelihood of accidental damage and spills.

- The number of concrete washout areas you install should depend on the expected demand for storage capacity.
- On large sites with extensive concrete work, concrete washout areas should be placed in multiple locations for ease of use by concrete truck drivers.

### **Concrete Truck Washout Procedures**

- Washout of concrete truck drums shall be performed in designated concrete washout areas only.
- Concrete washout from concrete pumper bins can be washed into concrete pumper trucks and discharged into designated concrete washout areas or properly disposed of off-site.

### **Concrete Washout Area Installation**

- Concrete washout areas should be constructed as shown in the figures below, with a recommended minimum length and minimum width of 10 ft, but with sufficient quantity and volume to contain all liquid and concrete waste generated by washout operations.
- Plastic lining material should be a minimum of 10 mil polyethylene sheeting and should be free of holes, tears, or other defects that compromise the impermeability of the material.
- Lath and flagging should be commercial type.
- Liner seams shall be installed in accordance with manufacturers' recommendations.
- Soil base shall be prepared free of rocks or other debris that may cause tears or holes in the plastic lining material.

## ***Maintenance Standards***

### **Inspection and Maintenance**

- Inspect and verify that concrete washout areas are in place prior to the commencement of concrete work.
- Once concrete wastes are washed into the designated washout area and allowed to harden, the concrete should be broken up, removed, and disposed of per applicable solid waste regulations. Dispose of hardened concrete on a regular basis.
- During periods of concrete work, inspect the concrete washout areas daily to verify continued performance.
  - Check overall condition and performance.
  - Check remaining capacity (% full).
  - If using self-installed concrete washout areas, verify plastic liners are intact and

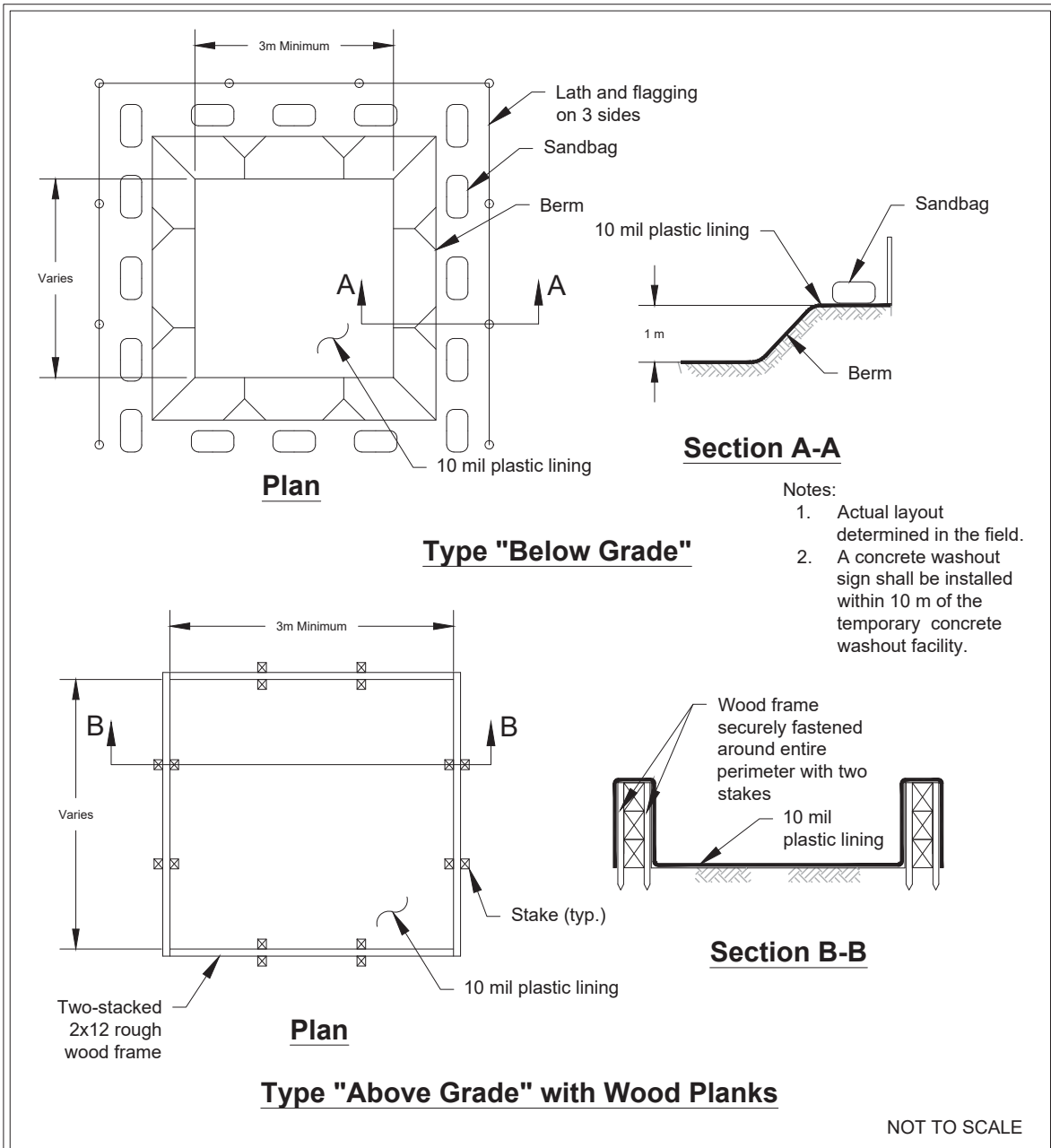
sidewalls are not damaged.

- If using prefabricated containers, check for leaks.
- Maintain the concrete washout areas to provide adequate holding capacity with a minimum freeboard of 12 inches.
- Concrete washout areas must be cleaned, or new concrete washout areas must be constructed and ready for use once the concrete washout area is 75% full.
- If the concrete washout area is nearing capacity, vacuum and dispose of the waste material in an approved manner.
  - Do not discharge liquid or slurry to waterways, storm drains or directly onto ground.
  - Do not discharge to the sanitary sewer without local approval.
  - Place a secure, non-collapsing, non-water collecting cover over the concrete washout area prior to predicted wet weather to prevent accumulation and overflow of precipitation.
  - Remove and dispose of hardened concrete and return the structure to a functional condition. Concrete may be reused on-site or hauled away for disposal or recycling.
- When you remove materials from a self-installed concrete washout area, build a new structure; or, if the previous structure is still intact, inspect for signs of weakening or damage, and make any necessary repairs. Re-line the structure with new plastic after each cleaning.

### **Removal of Concrete Washout Areas**

- When concrete washout areas are no longer required for the work, the hardened concrete, slurries and liquids shall be removed and properly disposed of.
- Materials used to construct concrete washout areas shall be removed from the site of the work and disposed of or recycled.
- Holes, depressions or other ground disturbance caused by the removal of the concrete washout areas shall be backfilled, repaired, and stabilized to prevent erosion.

**Figure 7.9: Concrete Washout Area with Wood Planks**

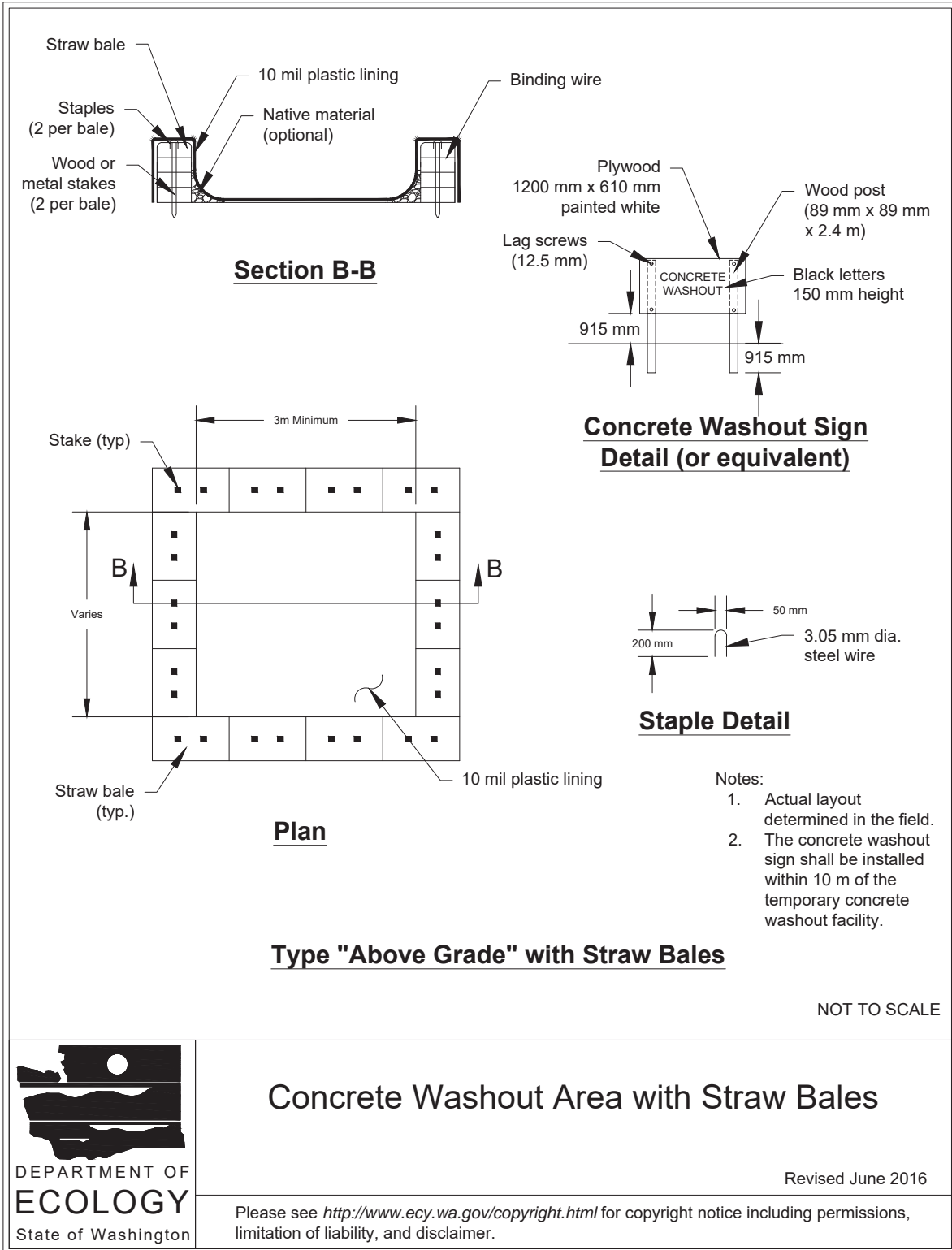


## Concrete Washout Area with Wood Planks

Revised June 2016

Please see <http://www.ecy.wa.gov/copyright.html> for copyright notice including permissions, limitation of liability, and disclaimer.

**Figure 7.10: Concrete Washout Area with Straw Bales**



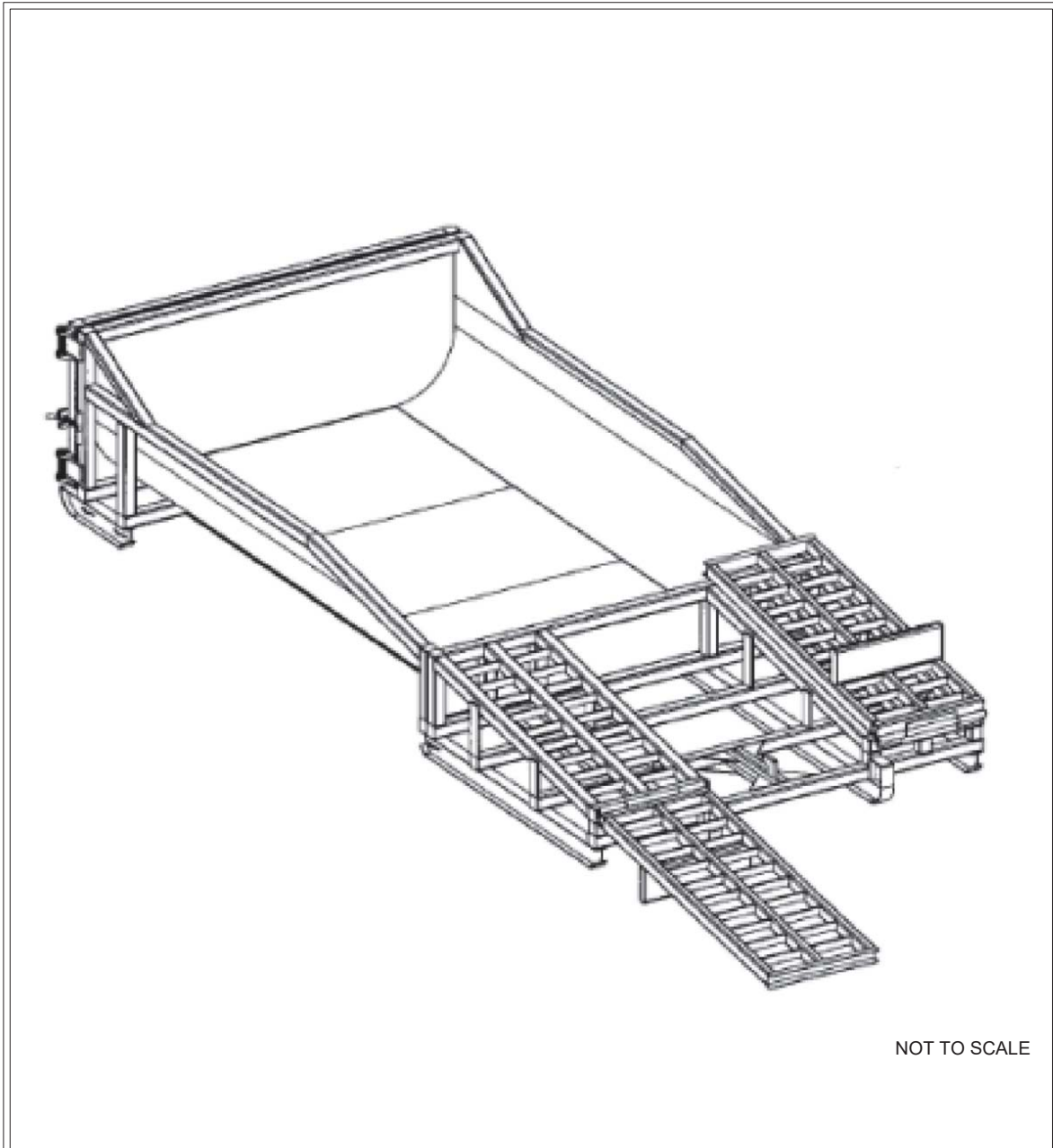
## Concrete Washout Area with Straw Bales

Revised June 2016

Please see <http://www.ecy.wa.gov/copyright.html> for copyright notice including permissions, limitation of liability, and disclaimer.



**Figure 7.11: Prefabricated Concrete Washout Container with Ramp**



## Prefabricated Concrete Washout Container with Ramp

Revised June 2016

Please see <http://www.ecy.wa.gov/copyright.html> for copyright notice including permissions, limitation of liability, and disclaimer.

## **BMP C160E: Certified Erosion and Sediment Control Lead**

### ***Purpose***

The project proponent designates at least one person as the responsible representative in charge of erosion and sediment control (ESC) and water quality protection. The designated employee or contact shall be the Certified Erosion and Sediment Control Lead (CESCL) who is responsible for ensuring compliance with all local, state, and federal ESC and water quality requirements.

### ***Conditions of Use***

A CESCL should be made available on projects  $\geq 1$  acre that discharge stormwater to surface waters of the state. Sites  $< 1$  acre do not require a CESCL certification for conducting inspections; sampling is not required on sites that disturb  $< 1$  acre. The CESCL shall meet one of the following requirements:

- Have a current certificate proving attendance in an ESC training course that meets the minimum ESC training and certification requirements established by Ecology. The minimum requirements for CESCL course training, as well as a list of ESC training and certification providers, are available on the Washington State Department of Ecology's Certified Erosion & Sediment Control Lead web page at the following address:

<https://ecology.wa.gov/Regulations-Permits/Permits-certifications/Certified-erosion-sediment-control>

- Be a Certified Professional in Erosion and Sediment Control (CPESC). For additional information, see the Envirocert CPESC website at the following address:

<http://www.envirocertintl.org/cpesc/>

### ***Specifications***

- CESCL certification shall remain valid for 3 years.
- The CESCL shall have authority to act on behalf of the contractor or developer and shall be available, on call, 24 hours per day throughout the period of construction.
- The Construction Stormwater Pollution Prevention Plan (SWPPP) shall include the name, telephone number, fax number, and address of the designated CESCL. See [Chapter 3 - Preparation of Stormwater Site Plans](#) and [7.2 Planning](#).
- A CESCL may provide inspection and compliance services for multiple construction projects in the same geographic region.
- Duties and responsibilities of the CESCL shall include, but are not limited to, the following:
  - Maintaining a permit file on-site at all times, which includes the SWPPP and any associated permits and plans
  - Directing BMP installation, inspection, maintenance, modification, and removal
  - Updating all project drawings and the Construction SWPPP with changes made

- Completing any sampling requirements including reporting results using electronic Discharge Monitoring Reports (WebDMR)
- Facilitating, participating in, and taking corrective actions resulting from inspections performed by outside agencies or the owner
- Keeping daily logs, and inspection reports. Inspection reports should include the following:
  - Inspection date/time
  - Weather information; general conditions during inspection and approximate amount of precipitation since the last inspection
  - Visual monitoring results, including a description of discharged stormwater and a notation of the presence of suspended sediment, turbid water, discoloration, and oil sheen, as applicable
  - Any water quality monitoring performed during inspection
  - General comments and notes, including a brief description of any BMP repairs, maintenance, or installations made as a result of the inspection
  - A summary or list of all BMPs implemented, including observations of all ESC structures or practices and the following:
    1. Locations of BMPs inspected
    2. Locations of BMPs that need maintenance
    3. Locations of BMPs that failed to operate as designed or intended
    4. Locations where additional or different BMPs are required

## **BMP C162E: Scheduling**

### ***Purpose***

Sequencing a construction project can reduce the amount and duration of soil exposed to erosion by wind, rain, runoff, and vehicle tracking.

### ***Conditions for Use***

The construction sequence schedule is an orderly listing of all major land-disturbing activities together with the necessary erosion and sediment control (ESC) BMPs planned for the project. This type of schedule guides the contractor on work to be done before other work is started so that serious erosion and sedimentation problems can be avoided.

Following a specified work schedule that coordinates the timing of land-disturbing activities and the installation of control measures is perhaps the most cost-effective way of controlling erosion during construction. The removal of ground cover leaves a site vulnerable to erosion. Construction

sequencing that limits land clearing, provides timely installation of ESC BMPs, and restores protective cover quickly can significantly reduce the erosion potential of a site.

### ***Design Considerations***

- Minimize construction during rainy periods.
- Schedule projects to disturb only small portions of the site at any one time. Complete grading as soon as possible. Immediately stabilize the disturbed portion before grading the next portion. Practice staged seeding in order to revegetate cut-and-fill slopes as the work progresses.

## **7.3.3 Runoff Conveyance and Treatment BMPs**

### **BMP C200E: Interceptor Dike and Swale**

#### ***Purpose***

Provide a dike of compacted soil or a swale at the top or base of a disturbed slope or along the perimeter of a disturbed construction area to convey stormwater. Use the dike and/or swale to intercept the runoff from unprotected areas and direct it to areas where erosion can be controlled. This can prevent storm runoff from entering the work area or sediment-laden runoff from leaving the construction site.

#### ***Conditions for Use***

Use an interceptor dike or swale where runoff from an exposed site or disturbed slope must be conveyed to an erosion control BMP that can safely convey the stormwater.

- Locate upslope of a construction site to prevent runoff from entering the disturbed area.
- When placed horizontally across a disturbed slope, it reduces the amount and velocity of runoff flowing down the slope.
- Locate downslope to collect runoff from a disturbed area and direct it to a sediment-trapping BMP (e.g., [BMP C240E: Sediment Trap](#), or [BMP C241E: Sediment Pond \(Temporary\)](#)).

#### ***Design Considerations***

- Dike and/or swale and channel must be stabilized with temporary or permanent vegetation or other channel protection during construction.
- Steep grades require channel protection and check dams.
- Review construction for areas where overtopping may occur.
- Can be used at the top of new fill before vegetation is established.
- May be used as a permanent diversion channel to carry the runoff.
- Contributing area for an individual dike or swale should be  $\leq 1$  acre.
- Design the dike and/or swale capacity as follows:

- Temporary interceptor dikes: Sized to handle the expected peak flow rate from a 6-month, 3-hour storm for the developed condition, referred to as the short-duration storm.
- Permanent interceptor dikes: The peak volumetric flow rate is calculated using a 10-minute time step for a 25-year, 24-hour frequency storm for the developed condition.

### **Interceptor Dikes**

Interceptor dikes shall meet the following criteria:

- Top Width: 2 feet minimum.
- Height: 1.5 feet minimum on berm.
- Side Slope: 2H:1V or flatter.
- Grade: Depends on topography; however, dike system minimum is 0.5%, and maximum is 1%.
- Compaction: Minimum of 90% ASTM D698 standard Proctor.
- Stabilization: Depends on velocity and reach. Inspect regularly to ensure stability.
- Ground Slopes < 5%: Seed and mulch should be applied within 5 days of dike construction (see [BMP C121E: Mulching](#)).
- Ground Slopes from 5% to 40%: Depends on runoff velocities and dike materials. Slope should be stabilized immediately using either sod or riprap, or other measures to avoid erosion.
- The upslope side of the dike shall provide positive drainage to the dike outlet. No erosion shall occur at the outlet. Provide energy dissipation measures as necessary. Sediment-laden runoff must be released through a sediment-trapping BMP.
- Minimize construction traffic over temporary dikes. Use temporary cross culverts for channel crossing.
- See [Table 7.16: Horizontal Spacing of Interceptor Dikes Along Ground Slope](#) for recommended horizontal spacing between dikes.

**Table 7.16: Horizontal Spacing of Interceptor Dikes Along Ground Slope**

Average Slope	Slope Percentage	Flow Path Length (feet)
20H:1V or less	3 to 5	300
(10 to 20)H:1V	5 to 10	200
(4 to 10)H:1V	10 to 25	100t
(2 to 4)H:1V	25 to 50	50

## **Interceptor Swales**

Interceptor swales shall meet the following criteria:

- Bottom Width: 2 feet minimum; the bottom shall be level
- Depth: 1 foot minimum
- Side Slope:  $\leq 2H:1V$
- Grade: Maximum 5%, with positive drainage to a suitable outlet (such as [BMP C241E: Sediment Pond \(Temporary\)](#))
- Stabilization: Seed per [BMP C120E: Temporary and Permanent Seeding](#) or [BMP C202E: Riprap Channel Lining](#), 12 inches thick of riprap pressed into the bank and extending  $\geq 8$  inches vertical from the bottom

## ***Maintenance Standards***

- Inspect diversion dikes and interceptor swales once a week and after every rainfall. Immediately remove sediment from the flow area.
- Damage caused by construction traffic or other activity must be repaired before the end of each working day.
- Check outlets and make timely repairs as needed to avoid gully formation. When the area below the temporary diversion dike is permanently stabilized, remove the dike and fill and stabilize the channel to blend with the natural surface.

## **BMP C201E: Grass-Lined Channels**

### ***Purpose***

To provide a channel with a vegetative lining for conveyance of runoff. The purpose of the vegetative lining is to prevent transport of sediment and erosion.

### ***Conditions of Use***

This practice applies to construction sites where concentrated runoff needs to be contained to prevent erosion or flooding.

- Use this BMP when a vegetative lining can provide sufficient stability for the channel cross section and at lower velocities of water (normally dependent on grade). This means that the channel slopes are generally  $< 5\%$  and space is available for a relatively large cross section.
- Typical uses include roadside ditches, channels at property boundaries, outlets for diversions, and other channels and drainage ditches in low areas.
- Channels that will be vegetated should be installed before major earthwork and hydroseeded with a bonded fiber matrix (BFM). The vegetation should be well established (i.e., 50% cover of all seeded areas after 3 months of active growth following germination during the growing season) before water is allowed to flow in the ditch. With channels that will have high flows,

erosion control blankets should be installed over the hydroseed. If vegetation cannot be established from seed before water is allowed in the ditch, sod should be installed in the bottom of the ditch in lieu of hydromulch and blankets.

## ***Design and Installation Specifications***

See [Figure 7.12: Typical Grass-Lined Channels](#).

- Locate channels where they can conform to the topography and other features such as roads. Use natural drainage systems to the greatest extent possible.
- Avoid sharp changes in alignment or bends and changes in grade.
- Do not reshape the landscape to fit the drainage channel.
- The maximum design velocity shall be based on soil conditions, type of vegetation, and method of revegetation, but at no time shall velocity > 5 feet per second (ft/sec). The channel shall not be overtopped by the peak volumetric flow rate calculated using the expected peak flow rate from a 6-month, 3-hour storm for the developed condition, referred to as the short-duration storm.
- Where the grass-lined channel will also function as a permanent stormwater conveyance, consult the conveyance requirements of the local jurisdiction.
- An established grass or vegetated lining is required before the channel can be used to convey stormwater, unless stabilized with nets or blankets (see [BMP C122E: Nets and Blankets](#)).
- If design velocity of a channel to be vegetated by seeding > 2 ft/sec, a temporary channel liner is required. Geotextile or special mulch protection such as fiberglass roving or straw and netting provides stability until the vegetation is fully established. See [Figure 7.13: Temporary Channel Liners](#).
- Check dams shall be removed when the grass has matured sufficiently to protect the ditch or swale unless the slope of the swale is > 4%. The area beneath the check dams shall be seeded and mulched immediately after dam removal.
- If vegetation is established by sodding, the permissible velocity for established vegetation may be used and no temporary liner is needed.
- Do not subject the grass-lined channel to sedimentation from disturbed areas. Use sediment-trapping BMPs upstream of the channel.
- V-shaped grass channels generally apply where the quantity of water is small, such as in short reaches along roadsides. The V-shaped cross section is least desirable because it is difficult to stabilize the bottom where velocities may be high.
- Trapezoidal grass channels are used where runoff volumes are large and slope is low so that velocities are nonerosive to vegetated linings.

**Note:** It is difficult to construct small parabolic channels.

- Subsurface drainage or riprap channel bottoms may be necessary on sites that are subject to prolonged wet conditions due to long-duration flows or a high water table.

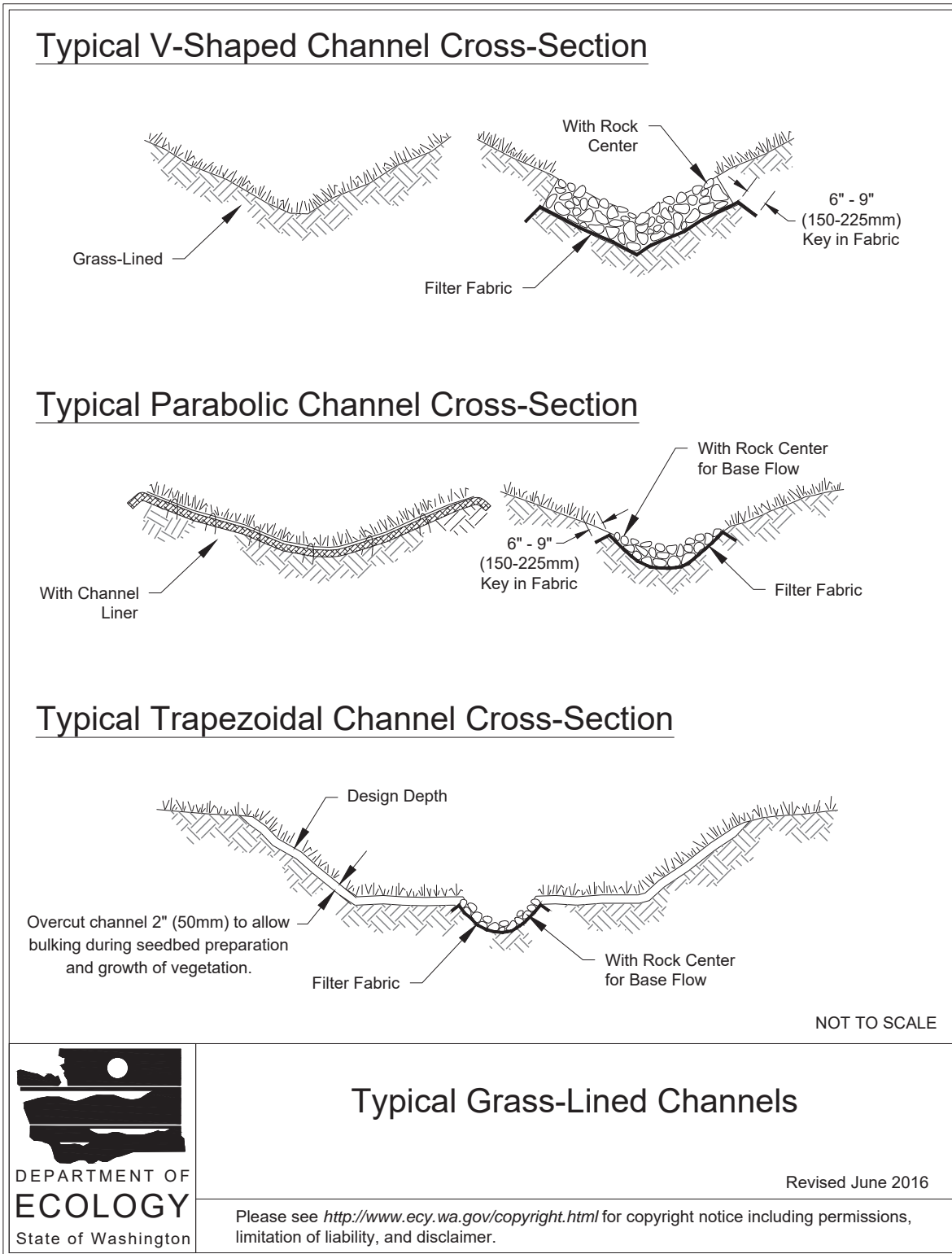
- Provide outlet protection at culvert ends and at channel intersections.
- Temporary grass channels, at a minimum, should carry peak runoff for the expected peak flow rate from a 6-month, 3-hour storm for the developed condition, referred to as the short-duration storm. Where flood hazard exists, increase the capacity according to the potential damage.
- Grassed channel side slopes generally are constructed  $\leq 3:1$  to aid in the establishment of vegetation and for maintenance.
- Construct channels a minimum of 0.2 feet larger around the periphery to allow for soil bulking during seedbed preparations and sod buildup.

### ***Maintenance Standards***

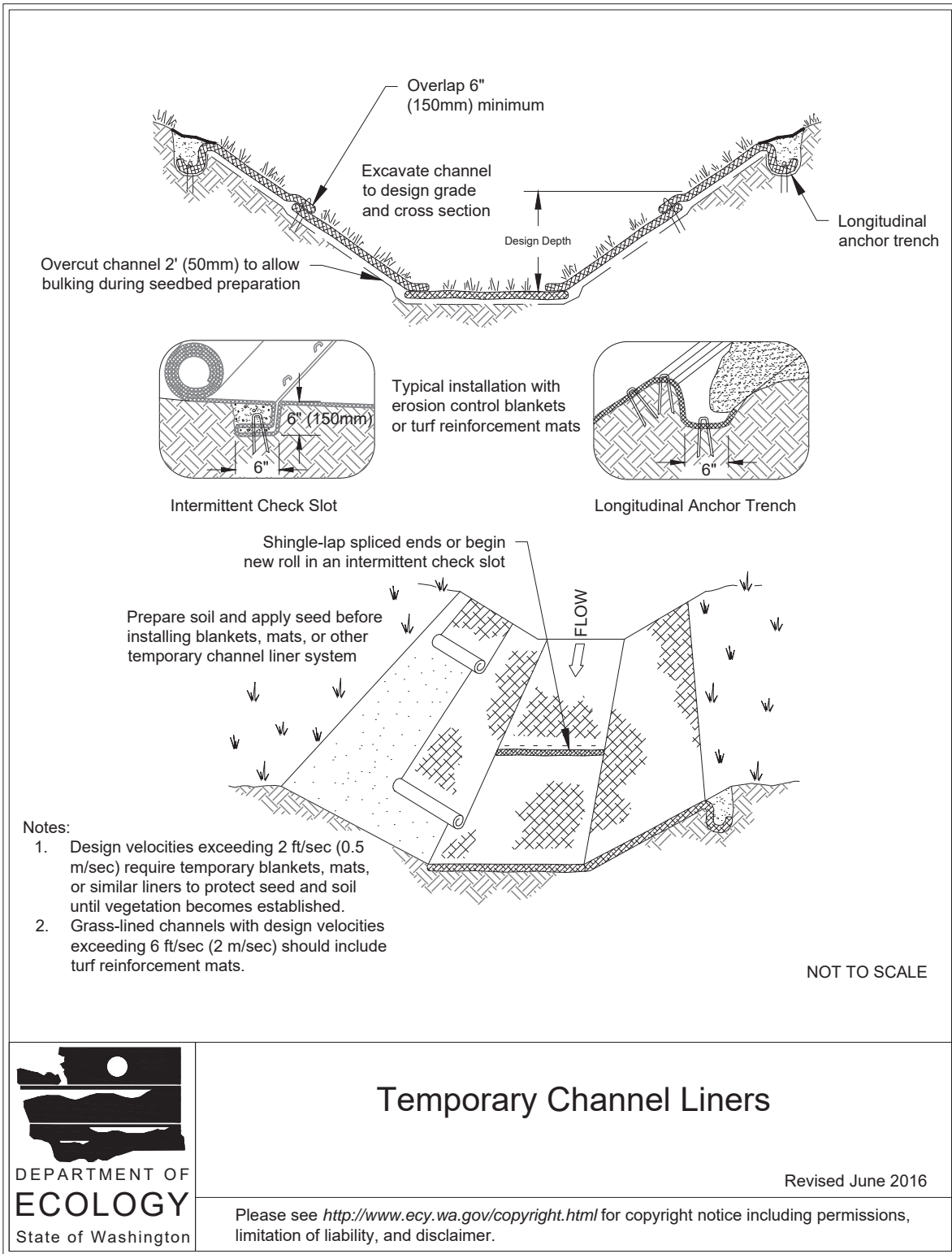
- During the establishment period, check grass-lined channels after every rainfall.
- After grass is established, periodically check the channel; check it after every heavy rainfall event. Immediately make repairs.
- Check the channel outlet and all road crossings for bank stability and evidence of piping or scour holes.
- Remove all significant sediment accumulations to maintain the designed carrying capacity. Keep the grass in a healthy, vigorous condition at all times, since it is the primary erosion protection for the channel.



**Figure 7.12: Typical Grass-Lined Channels**



**Figure 7.13: Temporary Channel Liners**



## Temporary Channel Liners

Revised June 2016

Please see <http://www.ecy.wa.gov/copyright.html> for copyright notice including permissions, limitation of liability, and disclaimer.

## **BMP C202E: Riprap Channel Lining**

### ***Purpose***

To protect erodible channels by providing a channel liner using riprap.

### ***Conditions of Use***

- Use this BMP when natural soils or vegetated stabilized soils in a channel are not adequate to prevent channel erosion.
- Use this BMP when a permanent ditch or pipe system is to be installed and a temporary measure is needed.
- An alternative to riprap channel lining is [BMP C122E: Nets and Blankets](#).
- The Federal Highway Administration recommends not using geotextile liners whenever the slope exceeds 10% or the shear stress exceeds 8 pounds per square foot.
- Since riprap is typically used where erosion potential is high, construction must be sequenced so that the riprap is put in place with the minimum possible delay.
- Disturb areas awaiting riprap only when final preparation and placement of the riprap can follow immediately behind the initial disturbance. Where riprap is used for outlet protection, the riprap should be placed before or in conjunction with the construction of the pipe or channel so that it is in place when the pipe or channel begins to operate.
- The designer, after determining the riprap size that will be stable under the flow conditions, shall consider that size to be a minimum size and then, based on riprap gradations actually available in the area, select the size or sizes that equal or exceed the minimum size. The possibility of drainage structure damage by others shall be considered in selecting a riprap size, especially if there is nearby water or a gully in which to toss the rocks.
- Rock for riprap shall consist of field stone or quarry rock that is approximately rectangular. The rock shall be hard and angular and of such quality that it will not disintegrate on exposure to water or weathering and it shall be suitable in all respects for the purpose intended. See the latest version of the Washington State Department of Transportation *Standard Specifications for Road, Bridge, and Municipal Construction*.
- A lining of engineering geotextile shall be placed between the riprap and the underlying soil surface to prevent soil movement into or through the riprap. The geotextile should be keyed in at the top of the bank.
- Geotextile shall not be used on slopes > 1.5:1 as slippage may occur. It should be used in conjunction with a layer of coarse aggregate (granular filter blanket) when the riprap to be placed is 12 inches and larger.

### ***Maintenance Standards***

Replace riprap as needed.

## BMP C203E: Water Bars

### Purpose

A water bar is a small ditch or ridge of material that is constructed diagonally across a road or right-of-way to divert stormwater runoff from the road surface, wheel tracks, or a shallow road ditch. See [Figure 7.14: Water Bars](#).

### Conditions of Use

Clearing right-of-way and construction of access for power lines, pipelines, and other similar installations often require long narrow rights-of-way over sloping terrain. Disturbance and compaction promotes gully formation in these cleared strips by increasing the volume and velocity of runoff. Gully formation may be especially severe in tire tracks and ruts. To prevent gullying, runoff can often be diverted across the width of the right-of-way to undisturbed areas by using small predesigned diversions.

Give special consideration to each individual outlet area, as well as to the cumulative effect of added diversions. Use gravel to stabilize the diversion where significant vehicle traffic is anticipated.

### Design and Installation Specifications

- Height: 8 inches minimum, measured from the channel bottom to the ridgetop.
- Side slope of channel: 2H:1V maximum; 3H:1V or flatter when vehicles will cross.
- Top width of ridge: 6 inches minimum.
- Locate water bars to use natural drainage systems and to discharge into well-vegetated stable areas.
- See [Table 7.17: Water Bar Spacing Guidelines](#) for spacing guidelines for water bars.

**Table 7.17: Water Bar Spacing Guidelines**

Slope Along Road (%)	Spacing (feet)
< 5	125
5 to 10	100
10 to 20	75
20 to 35	50
> 35	Use rock-lined ditch

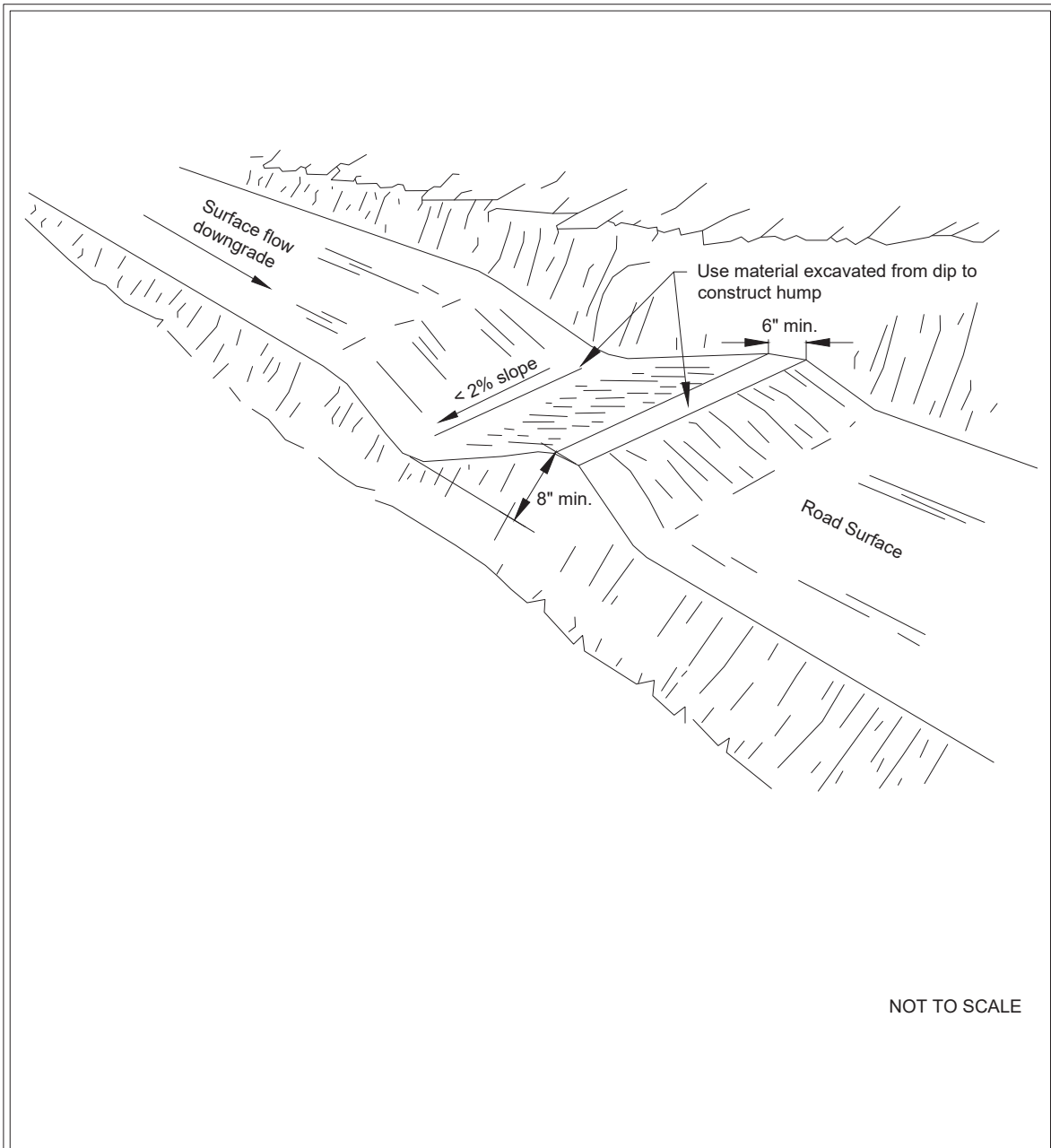
- Grade of water bar and angle: Select an angle that results in a ditch slope < 2%.
- Install the water bar as soon as the clearing and grading is completed. When utilities are being installed, reconstruct the water bar as construction is completed on each section.
- Compact the water bar ridge.

- Stabilize, seed, and mulch the portions that are not subjected to traffic. Place gravel in the areas crossed by vehicles.
- Note that [BMP C208E: Triangular Silt Dike \(TSD\)](#) can be used to create the ridge for the water bar.

### ***Maintenance Standards***

- Periodically inspect water bars for wear and after every heavy rainfall for wear and erosion damage.
- Immediately remove sediment from the flow area and repair the dike.
- Check outlet areas and make timely repairs as needed.
- When permanent road drainage is established and the area above the temporary water bar is permanently stabilized, remove the dike and fill the channel to blend with the natural ground, and appropriately stabilize the disturbed area.

**Figure 7.14: Water Bars**



NOT TO SCALE



DEPARTMENT OF  
**ECOLOGY**  
State of Washington

## Water Bars

Revised June 2016

Please see <http://www.ecy.wa.gov/copyright.html> for copyright notice including permissions, limitation of liability, and disclaimer.

## **BMP C204E: Pipe Slope Drains**

### ***Purpose***

The purpose of pipe slope drains is to prevent gullies, channel erosion, and saturation of slide-prone soils by using a pipe to convey stormwater away from or over bare soil.

### ***Conditions of Use***

Pipe slope drains should be used when a temporary or permanent stormwater conveyance is needed to move water down a steep slope to avoid erosion.

Pipe slope drains should be used at bridge ends to collect runoff and convey it to the base of the fill slopes along the bridge approaches. Another use on road projects is to collect runoff from pavement in a pipe slope drain and convey it away from side slopes.

Temporary installations of pipe slope drains can be useful because there is generally a time lag between having the first lift of asphalt installed and the curbs, gutters, and permanent drainage installed. Used in conjunction with sand bags, or other temporary diversion devices, these will prevent massive amounts of sediment from leaving a project.

Pipe slope drains can serve the following purposes:

- Connection to new catch basins and temporarily use until all permanent piping is installed.
- Drainage of water collected from aquifers exposed on cut slopes and conveyance of the water to the base of the slope.
- Collection of clean runoff from plastic sheeting and routing the runoff away from exposed soil.
- Installation in conjunction with silt fence to drain collected water to a controlled area.
- Diversion of small seasonal streams away from construction. They have been used successfully on culvert replacement and extension jobs. Large flex pipe can be used on larger streams during culvert removal, repair, or replacement.
- Connection to existing downspouts and roof drains and diversion of water away from work areas during building renovation, demolition, and construction projects.

There are several commercially available collectors that attach to the pipe inlet and help prevent erosion at the inlet.

### ***Design and Installation Specifications***

See [Figure 7.15: Pipe Slope Drain](#).

- Size the pipe to convey the projected flow:
  - Temporary pipe slope drains: Sized to handle the expected peak flow rate from a 6-month, 3-hour storm for the developed condition, referred to as the short-duration storm.
  - Permanent pipe slope drains: The peak volumetric flow rate is calculated using a 10-minute time step shall be sized for the 25-year, 24-hour frequency storm.

- Use care in clearing vegetated slopes for installation.
- Reestablish cover immediately on areas disturbed by installation.
- Use temporary drains on new cut or fill slopes.
- Use [BMP C200E: Interceptor Dike and Swale](#) to collect water at the top of the slope.
- Ensure that the entrance area is stable and large enough to direct flow into the pipe.
- Piping of water through the berm at the entrance area is a common failure mode.
- The entrance shall consist of a standard flared end section for culverts 12 inches and larger with a minimum 6-inch metal toe plate to prevent runoff from undercutting the pipe inlet. The slope of the entrance shall be  $\geq 3\%$ . Sand bags may also be used at pipe entrances as a temporary measure.
- The soil around and under the pipe and entrance section shall be thoroughly compacted to prevent undercutting.
- The flared inlet section shall be securely connected to the slope drain and have watertight connecting bands.
- Slope drain sections shall be securely fastened together, be fused, or have gasketed watertight fittings and shall be securely anchored into the soil.
- Thrust blocks should be installed anytime 90 degree bends are used. Depending on size of pipe and flow, these can be constructed with sand bags, straw bales staked in place, "T" posts and wire, or ecology blocks.
- Pipe needs to be secured along its full length to prevent movement. This can be done with steel "T" posts and wire. Install a post on each side of the pipe and wire the pipe to the posts. This should be done every 10 to 20 feet of pipe length or so, depending on the size of the pipe and quantity of water to be diverted.
- [BMP C200E: Interceptor Dike and Swale](#) shall be used to direct runoff into a pipe slope drain. The height of the dike shall be  $\geq 1$  foot higher at all points than the top of the inlet pipe.
- The area below the outlet must be stabilized (see [BMP C209E: Outlet Protection](#)).
- If the pipe slope drain is conveying sediment-laden water, direct all flows into a sediment-trapping BMP.
- Materials specifications for any permanent piped system shall be set by the local jurisdiction.

## **Maintenance Standards**

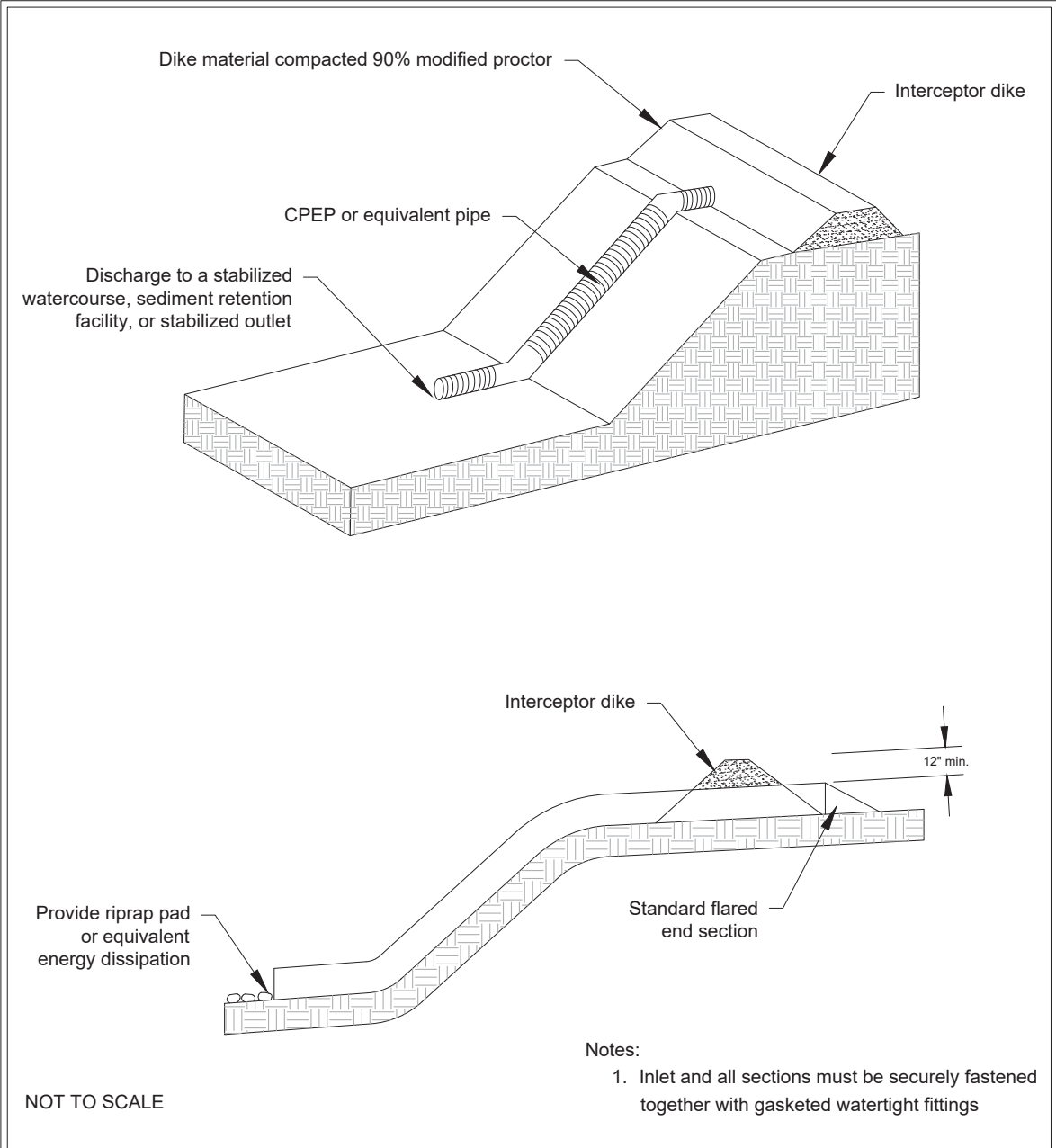
Check inlet and outlet points regularly, especially after storms.

- The inlet should be free of undercutting, and no water should be going around the point of entry. If there are problems, the headwall should be reinforced with compacted earth or sand bags.
- The outlet point should be free of erosion and installed with appropriate outlet protection.



- For permanent installations, inspect the pipe periodically for vandalism and physical distress such as slides and windthrow. Clean the pipe and outlet structure at the completion of construction.
- Normally the pipe slope is so steep that clogging is not a problem with smooth wall pipe, however, debris may become lodged in the pipe.

**Figure 7.15: Pipe Slope Drain**



**Pipe Slope Drain**

Revised June 2016

Please see <http://www.ecy.wa.gov/copyright.html> for copyright notice including permissions, limitation of liability, and disclaimer.

## **BMP C205E: Subsurface Drains**

### ***Purpose***

The purpose of subsurface drains is to intercept, collect, and convey ground water to a satisfactory outlet, using a perforated pipe or other conduit below the ground surface. Subsurface drains are also known as “French drains.” The perforated pipe provides a dewatering mechanism to drain excessively wet soils; providing a stable base for construction, improving the stability of structures with shallow foundations, or reducing hydrostatic pressure to improve slope stability.

### ***Conditions of Use***

Use subsurface drains when excessive water must be removed from the soil. The soil permeability, depth to water table, and impervious layers are all factors that may govern the use of subsurface drains.

### ***Design and Installation Specifications***

#### **Subsurface Drain Type: Relief Drains**

- Relief drains are used to lower the water table in large, relatively flat areas, to improve the growth of vegetation, or to remove surface water.
- Relief drains are installed along a slope and drain in the direction of the slope.
- Relief drains can be installed in a grid pattern, a herringbone pattern, or a random pattern.

#### **Subsurface Drain Type: Interceptor Drains**

- Interceptor drains are used to remove excess ground water from a slope, stabilize steep slopes, and lower the water table immediately below a slope to prevent the soil from becoming saturated.
- Interceptor drains are installed perpendicular to a slope and drain to the side of the slope.
- Interceptor drains usually consist of a single pipe or series of single pipes instead of a patterned layout.

#### **Subsurface Drain Depth and Spacing**

- The depth of a subsurface drain is determined primarily by the depth to which the water table is to be lowered or the depth to a confining layer. For practical reasons, the maximum depth is usually limited to 6 feet, with a minimum cover of 2 feet to protect the conduit.
- The soil should have depth and sufficient permeability to permit installation of an effective drainage system at a depth of 2 to 6 feet.

#### **Subsurface Drain Sizing and Placement**

- The quantity and quality of discharge needs to be accounted for in the receiving stream (additional detention may be required).

- The size of a subsurface drain is determined by first calculating the maximum rate of ground water flow to be intercepted and then choosing a subsurface drain pipe (or pipes) with enough capacity to convey that flow. Therefore, it is good practice to make complete subsurface investigations, including hydraulic conductivity of the soil, before designing a subsurface drainage system.
- Size subsurface drains to carry the required capacity without pressure flow. Minimum diameter for a subsurface drain is 4 inches.
- The minimum velocity in the pipe required to prevent silting is 1.4 feet per second (ft/sec). Grade the subsurface drain to achieve this velocity at a minimum. The maximum allowable velocity using a sand-gravel filter or envelope is 9 ft/sec.
- Filter material and fabric shall be used around all drains for proper bedding and filtration of fine materials. Envelopes and filters should surround the drain to a minimum thickness of 3 inches.
- The trench shall be constructed on a continuous grade with no reverse grades or low spots.
- Soft or yielding soils under the subsurface drain shall be stabilized with gravel or other suitable material.
- Backfilling shall be done immediately after placement of the pipe. No sections of pipe shall remain uncovered overnight or during a rainstorm. Backfill material shall be placed in the trench in such a manner that the drain pipe is not displaced or damaged.
- Do not install permanent drains near trees to avoid the tree roots that tend to clog the line. Use solid pipe with watertight connections where it is necessary to pass a subsurface drainage system through a stand of trees.

### **Subsurface Drain Outlets**

- An adequate outlet for the subsurface drain must be available either by gravity or by pumping.
- The outlet of the subsurface drain shall empty into a sediment-trapping BMP through a catch basin. If free of sediment, it can then empty into a receiving channel, swale, or stable vegetated area adequately protected from erosion and undermining.
- Ensure that the outlet of a subsurface drain empties into a channel or other receiving water above the normal water level.
- Secure an animal guard to the outlet end of the pipe to keep out rodents.
- Use outlet pipe of corrugated metal, cast iron, or heavy-duty plastic without perforations and  $\geq 10$  feet long. Do not use an envelope or filter material around the outlet pipe, and bury  $\geq$  two-thirds of the pipe length.
- When outlet velocities exceed those allowable for the receiving stream, outlet protection must be provided.

## ***Maintenance Standards***

Subsurface drains shall be checked periodically to ensure that they are free-flowing and have not become clogged with sediment or roots.

- The outlet shall be kept clean and free of debris.
- Surface inlets shall be kept open and free of sediment and other debris.
- Trees located too close to a subsurface drain often clog the system with their roots. If a drain becomes clogged, relocate the drain or remove the trees as a last resort. Drain placement should be planned to minimize this problem.
- Where drains are crossed by heavy vehicles, the line shall be checked to ensure that it is not crushed.

## **BMP C206E: Level Spreader**

### ***Purpose***

The purpose of a level spreader as a construction stormwater BMP is to provide a temporary outlet for dikes and diversions and convert concentrated runoff to sheet flow prior to releasing it to stabilized areas.

### ***Conditions of Use***

Use level spreaders when a concentrated flow of water needs to be dispersed over a large area with existing stable vegetation.

- Use only where the slopes are gentle, the water volume is relatively low, and the soil will adsorb most of the low flow events.

There are two conditions to consider:

- What is the risk of erosion or damage if the flow may become concentrated?
- Is an easement required if the flow is discharged to adjoining property?

### ***Design and Installation Specifications***

- Use above undisturbed areas that are stabilized by existing vegetation.
- Discharge area below the outlet must be uniform with a slope of < 5H:1V.
- Do not allow any low points in the level spreader. If the level spreader has any low points, flow will concentrate, create channels, and may cause erosion.
- Ensure the outlet is level in a stable, undisturbed soil profile (not on fill).
- The runoff shall not reconcentrate on-site after release from the level spreader unless it is intercepted by another downstream measure.
- The grade of the channel for the last 20 feet of the dike or interceptor entering the level spreader shall be  $\leq 1\%$ . The grade of the level spreader shall be 0% to ensure uniform

spreading of runoff.

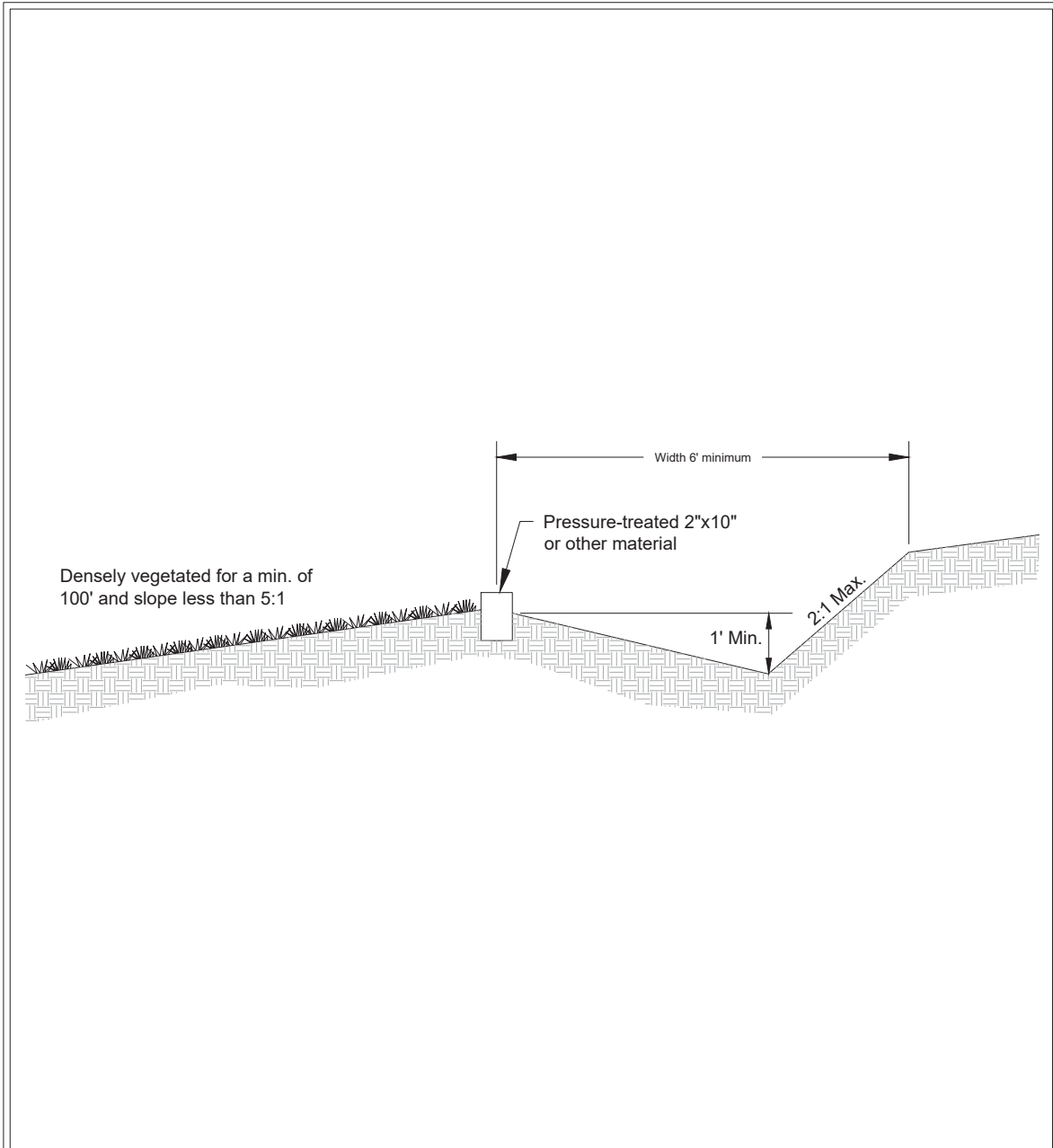
- A 6-inch-high gravel berm placed across the level lip shall consist of washed crushed rock, 2- to 4-inch or 0.75- to 1.5-inch size.
- The spreader length must handle the expected peak flow rate from a 6-month, 3-hour storm for the developed condition, referred to as the short-duration storm. The length of the spreader shall be a minimum of 15 feet for 0.1 cubic foot per second (cfs) and shall be 10 feet for each 0.1 cfs thereafter to a maximum of 0.5 cfs per spreader. Use multiple spreaders for higher flows.
- The width of the approach to spreader should be  $\geq 6$  feet.
- The depth of the spreader as measured from the lip should be  $\geq 6$  inches and it should be uniform across the entire length.
- Level spreaders shall be set back from the property line unless there is an easement for flow.
- Materials that can be used for level spreaders include sand bags, lumber, logs, concrete, pipe, and capped perforated pipe. To function properly, the material needs to be installed level and on contour.
- See [Figure 7.16: Cross Section of Level-Spreader](#) and [Figure 7.17: Detail of Level Spreader](#).

### ***Maintenance Standards***

The level spreader should be inspected during and after runoff events to ensure that it is functioning correctly.

- The contractor should avoid the placement of any material on the level spreader and should prevent construction traffic from crossing over the level spreader.
- If the level spreader is damaged by construction traffic, it shall be immediately repaired.

**Figure 7.16: Cross Section of Level-Spreader**

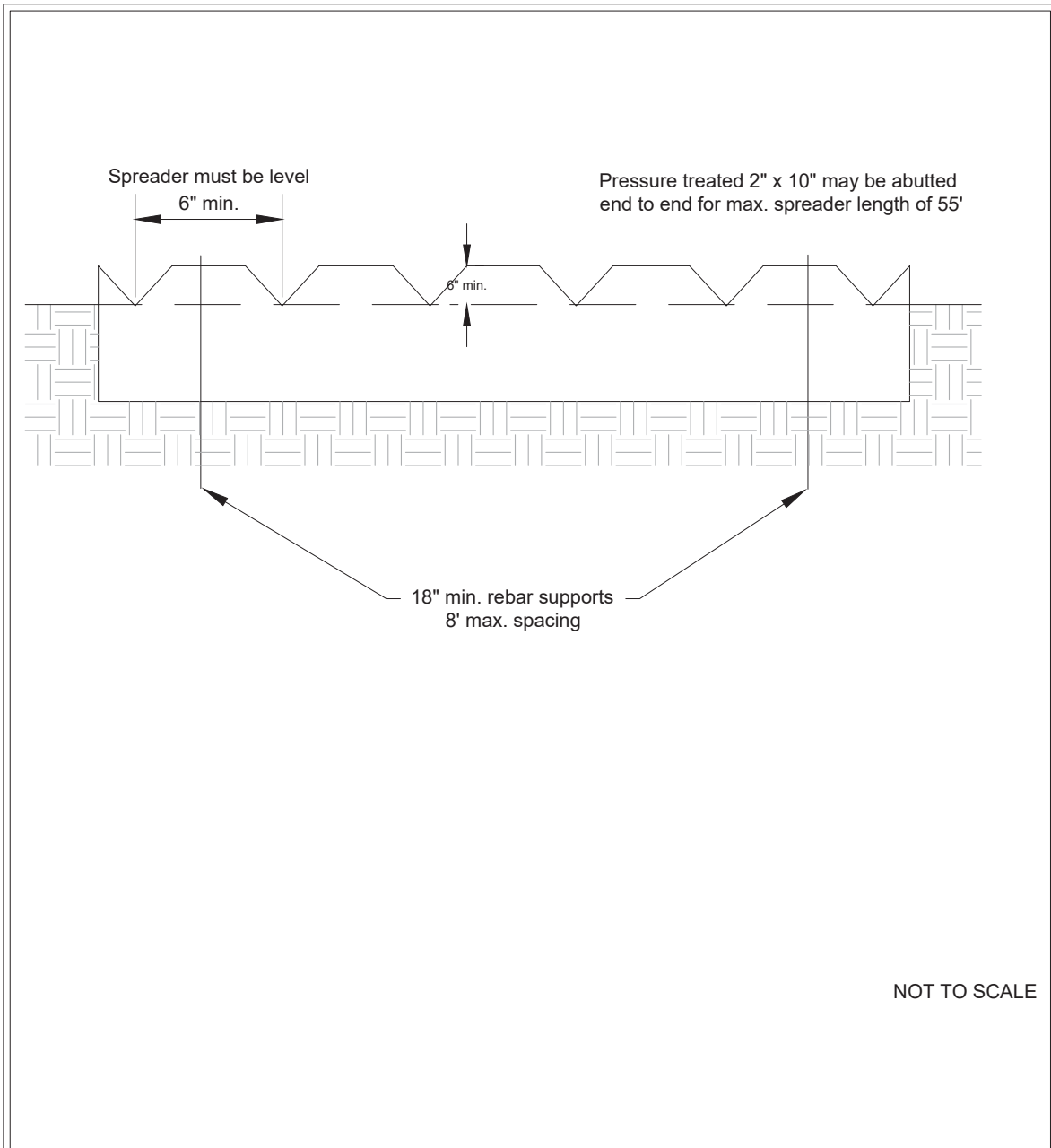


### Cross Section of Level-Spreader

Revised June 2016

Please see <http://www.ecy.wa.gov/copyright.html> for copyright notice including permissions, limitation of liability, and disclaimer.

**Figure 7.17: Detail of Level Spreader**



NOT TO SCALE



### Detail of Level Spreader

Revised June 2016

Please see <http://www.ecy.wa.gov/copyright.html> for copyright notice including permissions, limitation of liability, and disclaimer.



## **BMP C207E: Check Dams**

### ***Purpose***

Construction of check dams across a swale or ditch reduces the velocity of concentrated flow and dissipates energy at the check dam.

### ***Conditions of Use***

Use check dams where temporary channels or permanent channels are not yet vegetated, channel lining is infeasible, and velocity checks are required.

- Check dams may not be placed in streams unless approved by the Washington State Department of Fish and Wildlife.
- Check dams may not be placed in wetlands without approval from a permitting agency.
- Do not place check dams below the expected backwater from any salmonid-bearing water between October 1 and May 31 to ensure that there is no loss of high-flow refuge habitat for overwintering juvenile salmonids and emergent salmonid fry.

### ***Design and Installation Specifications***

- Construct rock check dams from appropriately sized rock. The rock used must be large enough to stay in place given the expected design flow through the channel. The rock must be placed by hand or by mechanical means (do not dump the rock to form the dam) to achieve complete coverage of the ditch or swale and to ensure that the center of the dam is lower than the edges.
- Check dams may also be constructed of either rock or pea-gravel filled bags. Numerous new products are also available for this purpose. They tend to be reusable, quick and easy to install, effective, and cost efficient.
- Place check dams perpendicular to the flow of water.
- The check dam should form a triangle when viewed from the side. This prevents undercutting as water flows over the face of the check dam rather than falling directly onto the ditch bottom.
- Before installing a check dam, impound and bypass upstream water flow away from the work area. Options for bypassing include pumps, siphons, or temporary channels.
- Check dams combined with sumps work more effectively at slowing flow and retaining sediment than a check dam alone. A deep sump should be provided immediately upstream of the check dam.
- In some cases, if carefully located and designed, check dams can remain as permanent installations with very minor regrading. They may be left as either spillways, in which case accumulated sediment would be graded and seeded, or as check dams to prevent further sediment from leaving the site.
- The maximum spacing between the check dams shall be such that the downstream toe of the upstream dam is at the same elevation as the top of the downstream dam.

- Keep the maximum height at 2 feet at the center of the check dam.
- Keep the center of the check dam  $\geq$  12 inches lower than the outer edges at natural ground elevation.
- Keep the side slopes of the check dam at  $\leq$  2H:1V.
- Key the rock into the ditch banks and extend it beyond the abutments a minimum of 18 inches to avoid washouts from overflow around the dam.
- Use geotextile foundation under a rock or sand bag check dam. If a blanket ditch liner is used, geotextile is not necessary. A piece of organic or synthetic blanket cut to fit will also work for this purpose.
- In the case of grass-lined ditches and swales, all check dams and accumulated sediment shall be removed when the grass has matured sufficiently to protect the ditch or swale—unless the slope of the swale is  $>$  4%. The area beneath the check dams shall be seeded and mulched immediately after dam removal.
- Ensure that channel appurtenances, such as culvert entrances below check dams, are not subject to damage or blockage from displaced rocks.
- See [Figure 7.18: Rock Check Dam](#).

### ***Maintenance Standards***

Check dams shall be monitored for performance and sediment accumulation during and after each rainfall that produces runoff. Sediment shall be removed when it reaches one-half the sump depth.

- Anticipate submergence and deposition above the check dam and erosion from high flows around the edges of the dam.
- If significant erosion occurs between dams, install a protective riprap liner in that portion of the channel. See BMP C202E (Riprap Channel Lining).

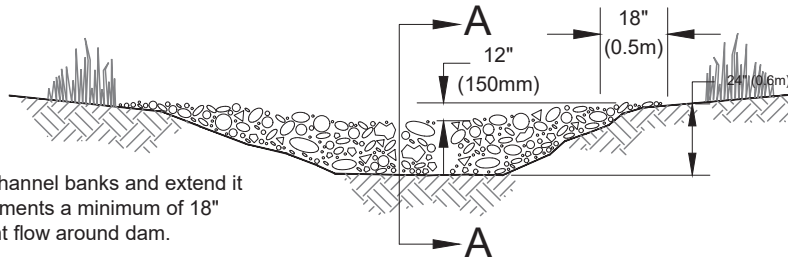
### ***Approved as Functionally Equivalent***

Ecology has approved products as able to meet the requirements of this BMP. The products did not pass through the Technology Assessment Protocol–Ecology (TAPE) process. Local jurisdictions may choose not to accept these products or may require additional testing prior to consideration for local use. Products that Ecology has approved as functionally equivalent are available for review on Ecology’s Emerging Stormwater Treatment Technologies (TAPE) web page at the following address:

<https://ecology.wa.gov/Regulations-Permits/Guidance-technical-assistance/Stormwater-permittee-guidance-resources/Emerging-stormwater-treatment-technologies>

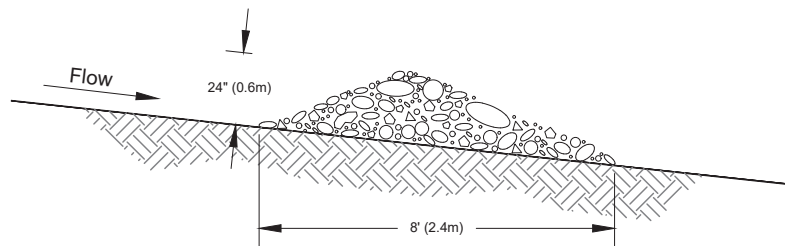
**Figure 7.18: Rock Check Dam**

View Looking Upstream

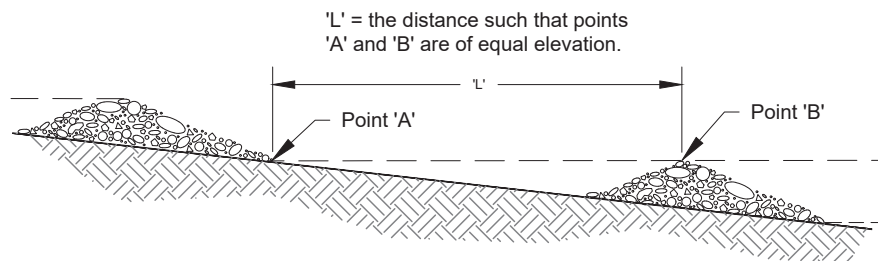


Note:  
Key stone into channel banks and extend it beyond the abutments a minimum of 18" (0.5m) to prevent flow around dam.

Section A-A



Spacing Between Check Dams



NOT TO SCALE



**Rock Check Dam**

Revised June 2016

Please see <http://www.ecy.wa.gov/copyright.html> for copyright notice including permissions, limitation of liability, and disclaimer.

## **BMP C208E: Triangular Silt Dike (TSD)**

### ***Purpose***

Triangular silt dikes (TSDs) may be used as check dams, for perimeter protection, for temporary soil stockpile protection, for drop inlet protection, or as a temporary interceptor dike.

### ***Conditions of Use***

- TSDs may be used on soil or pavement with adhesive or staples.
- TSDs have been used to build temporary BMPs:
  - [BMP C241E: Sediment Pond \(Temporary\)](#)
  - [BMP C200E: Interceptor Dike and Swale](#)
  - [BMP C154E: Concrete Washout Area](#)
  - [BMP C203E: Water Bars](#)
  - [BMP C206E: Level Spreader](#)
  - [BMP C220E: Inlet Protection](#)
  - [BMP C207E: Check Dams](#)
  - Curbing
  - Berms

### ***Design and Installation Specifications***

- TSDs are made of urethane foam sewn into a woven geosynthetic fabric.
- TSDs are triangular, 10 to 14 inches high in the center, with a 20- to 28-inch base. A 2-foot apron extends beyond both sides of the triangle along its standard section of 7 feet. A sleeve at one end allows attachment of additional sections as needed.
- Install with ends curved up to prevent water from flowing around the ends.
- The fabric flaps and check dam units are attached to the ground with wire staples. Wire staples should be No. 11 gauge wire and 200 to 300 millimeters in length.
- When multiple units are installed, the sleeve of fabric at the end of the unit shall overlap the abutting unit and be stapled.
- When TSDs are used as check dams, the following guidelines apply:
  - TSDs should be located and installed as soon as construction will allow.
  - TSDs should be placed perpendicular to the flow of water.
  - The leading edge of the TSD must be secured with rocks, sandbags, or a small key slot

and staples.

- In the case of grass-lined ditches and swales, check dams and accumulated sediment shall be removed when the grass has matured sufficiently to protect the ditch or swale unless the slope of the swale is > 4%. The area beneath the check dams shall be seeded and mulched immediately after dam removal.

### **Maintenance Standards**

- Inspect TSDs for performance and sediment accumulation during and after each rainfall that produces runoff. Remove sediments when it reaches one-half the height of the TSD.
- Anticipate submergence and deposition above the TSD and erosion from high flows around the edges of the TSD. Immediately repair any damage or any undercutting of the TSD.

## **BMP C209E: Outlet Protection**

### **Purpose**

Outlet protection prevents scour at conveyance outlets and minimizes the potential for downstream erosion by reducing the velocity of concentrated stormwater flows.

### **Conditions of Use**

Use outlet protection at the outlets of all ponds, pipes, ditches, or other conveyances that discharge to a natural or constructed drainage feature such as a stream, wetland, lake, or ditch.

### **Design and Installation Specifications**

- The receiving channel at the outlet of a culvert shall be protected from erosion by lining a minimum of 6 feet downstream and extending up the channel sides a minimum of 1 foot above the maximum tailwater elevation or 1 foot above the crown, whichever is higher. For pipes > 18 inches in diameter, the outlet protection lining of the channel shall be four times the diameter of the culvert.
- Standard wing walls, tapered outlets, and paved channels should also be considered when appropriate for permanent culvert outlet protection (see the latest version of the Washington State Department of Transportation Hydraulics Manual).
- [BMP C122E: Nets and Blankets](#) or [BMP C202E: Riprap Channel Lining](#) provides suitable options for lining materials.
- With low flows, [BMP C201E: Grass-Lined Channels](#) can be an effective alternative for lining material.
- The following guidelines shall be used for riprap outlet protection with riprap:
  - If the discharge velocity at the outlet is < 5 feet per second (ft/sec), use 2- to 8-inch riprap. Minimum thickness is 1 foot.
  - For a discharge velocity of 5 to 10 fps at the outlet, use 24- to 4-foot riprap. Minimum thickness is 2 feet.

- For outlets at the base of steep slope pipes (pipe slope > 10%), use an engineered energy dissipater.
- Geotextile or erosion control blankets should always be used under riprap to prevent scour and channel erosion. See [BMP C122E: Nets and Blankets](#).
- Bank stabilization, bioengineering, and habitat features may be required for disturbed areas. This work may require a Hydraulic Project Approval (HPA) from the Washington State Department of Fish and Wildlife.

**For more information:** See [1.4.9 Hydraulic Project Approvals](#).

### ***Maintenance Standards***

- Inspect and repair as needed.
- Add rock as needed to maintain the intended function.
- Clean energy dissipater if sediment builds up.

## **BMP C220E: Inlet Protection**

### ***Purpose***

Inlet protection prevents coarse sediment from entering drainage systems prior to permanent stabilization of the disturbed area.

### ***Conditions of Use***

Use inlet protection at inlets that are operational before permanent stabilization of the disturbed areas that contribute runoff to the inlet. Provide protection for all storm drain inlets downslope and within 500 feet of a disturbed or construction area, unless those inlets are preceded by a sediment-trapping BMP.

Also consider inlet protection for lawn and yard drains on new home construction. These small and numerous drains coupled with lack of gutters can add significant amounts of sediment into the roof drain system. If possible, delay installing lawn and yard drains until just before landscaping, or cap these drains to prevent sediment from entering the system until completion of landscaping. Provide 18 inches of sod around each finished lawn and yard drain.

[Table 7.18: Storm Drain Inlet Protection](#) lists several options for inlet protection. All of the methods for inlet protection tend to become plugged and require a high frequency of maintenance. Limit contributing areas for an individual inlet to  $\leq 1$  acre. If possible, provide emergency overflows with additional end-of-pipe treatment where stormwater ponding would cause a hazard.

**Table 7.18: Storm Drain Inlet Protection**

Type of Inlet Protection	Emergency Overflow	Applicable for Paved/ Earthen Surfaces	Conditions of Use
<b>Drop Inlet Protection</b>			
Excavated drop inlet protection	Yes, temporary flooding will occur	Earthen	Applicable for heavy flows. Easy to maintain. Large area requirement: 30-feet by 30-feet/acre
Block and gravel drop inlet protection	Yes	Paved or earthen	Applicable for heavy concentrated flows. Will not pond.
Gravel and wire drop inlet protection	No	Paved or earthen	Applicable for heavy concentrated flows. Will pond. Can withstand traffic.
Catch basin filters	Yes	Paved or earthen	Frequent maintenance required.
<b>Curb Inlet Protection</b>			
Curb inlet protection with a wooden weir	Small capacity overflow	Paved	Used for sturdy, more compact installation.
Block and gravel curb inlet protection	Yes	Paved	Sturdy, but limited filtration.
<b>Culvert Inlet Protection</b>			
Culvert inlet sediment trap	Not applicable	Not applicable	18-month expected life.

## ***Design and Installation Specifications***

### **Excavated Drop Inlet Protection**

Excavated drop inlet protection consists of an excavated impoundment around the storm drain inlet. Sediment settles out of the stormwater prior to entering the storm drain. Design and installation specifications for excavated drop inlet protection include:

- Provide a depth 1 to 2 feet as measured from the crest of the inlet structure.
- Side slopes of excavation should be  $\leq 2H:1V$ .
- Minimum volume of excavation is 35 cubic yards.
- Shape the excavation to fit the site, with the longest dimension oriented toward the longest inflow area.
- Install provisions for draining to prevent standing water.
- Clear the area of all debris.
- Grade the approach to the inlet uniformly.

- Drill weep holes into the side of the inlet.
- Protect weep holes with screen wire and washed aggregate.
- Seal weep holes when removing structure and stabilizing area.
- Build a temporary dike, if necessary, to the downslope side of the structure to prevent bypass flow.

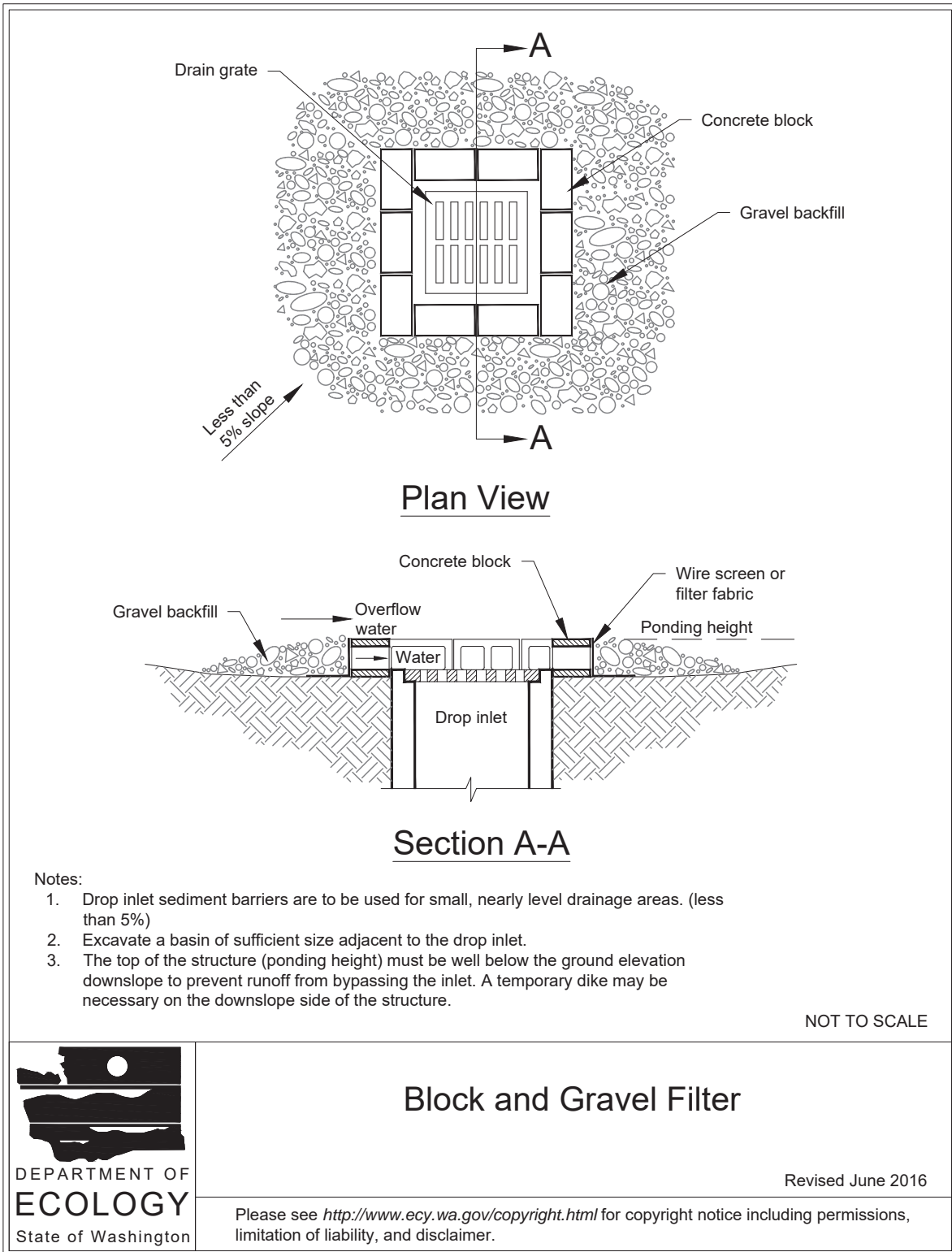
### **Block and Gravel Filter**

A block and gravel filter is a barrier formed around the inlet with standard concrete blocks and gravel. See [Figure 7.19: Block and Gravel Filter](#). Design and installation specifications for block and gravel filters include:

- Provide a height 1 to 2 feet above the inlet.
- Recess the first row of blocks 2 inches into the ground for stability.
- Support subsequent courses by placing a piece of pressure-treated wood (2x4) through the block opening.
- Do not use mortar.
- Lay some blocks in the bottom row on their side to allow for dewatering the pool.
- Place hardware cloth or comparable wire mesh with 0.5-inch openings over all block openings.
- Place gravel to just below the top of blocks on slopes of 2H:1V or flatter.
- An alternative design is a gravel berm surrounding the inlet, as follows:
  - Provide a slope of 3H:1V on the upstream side of the berm.
  - Provide a slope of 2H:1V on the downstream side of the berm.
  - Provide a 1-foot-wide level rock area between the gravel berm and the inlet.
  - Use rocks  $\geq$  3 inches in diameter on the upstream slope of the berm.
  - Use gravel with a diameter of 0.5 to 0.75 inches at a minimum thickness of 1 foot on the downstream slope of the berm.



**Figure 7.19: Block and Gravel Filter**



### **Gravel and Wire Mesh Filter**

Gravel and wire mesh filters are gravel barriers placed over the top of the inlet. This method does not provide an overflow. Design and installation specifications for gravel and wire mesh filters include:

- Use a hardware cloth or comparable wire mesh with 0.5-inch openings.
  - Place wire mesh over the drop inlet so that the wire extends a minimum of 1 foot beyond each side of the inlet structure.
  - Overlap the strips if more than one strip of mesh is necessary.
- Place coarse aggregate over the wire mesh.
  - Provide  $\geq$  12-inch depth of aggregate over the entire inlet opening and extend  $\geq$  18 inches on all sides.

### **Catch Basin Filters**

Catch basin filters are designed by manufacturers for construction sites. The limited sediment storage capacity increases the amount of inspection and maintenance required, which may be daily for heavy sediment loads. To reduce maintenance requirements, combine a catch basin filter with another type of inlet protection. This combined inlet protection provides flow bypass without overflow and therefore may be a better method for inlets located along active rights-of-way. Design and installation specifications for catch basin filters include:

- Provide 5 cubic feet of storage.
- Require dewatering provisions.
- Provide a high-flow bypass that will not become clogged under normal use at a construction site.
- Insert the catch basin filter in the catch basin just below the grating.

### **Curb Inlet Protection With Wooden Weir**

Curb inlet protection with wooden weir is an option that consists of a barrier formed around a curb inlet with a wooden frame and gravel. Design and installation specifications for curb inlet protection with wooden weirs include:

- Use wire mesh with 0.5-inch openings.
- Use extra strength filter cloth.
- Construct a frame.
- Attach the wire and filter fabric to the frame.
- Pile coarse washed aggregate against the wire and fabric.
- Place weight on the frame anchors.

### **Block and Gravel Curb Inlet Protection**

Block and gravel curb inlet protection is a barrier formed around a curb inlet with concrete blocks and gravel. See [Figure 7.20: Block and Gravel Curb Inlet Protection](#). Design and installation specifications for block and gravel curb inlet protection include:

- Use wire mesh with 0.5-inch openings.
- Place two concrete blocks on their sides abutting the curb at either side of the inlet opening. These are spacer blocks.
- Place a 2x4 stud through the outer holes of each spacer block to align the front blocks.
- Place blocks on their sides across the front of the inlet and abutting the spacer blocks.
- Place wire mesh over the outside vertical face.
- Pile coarse aggregate against the wire to the top of the barrier.

### **Curb and Gutter Sediment Barrier**

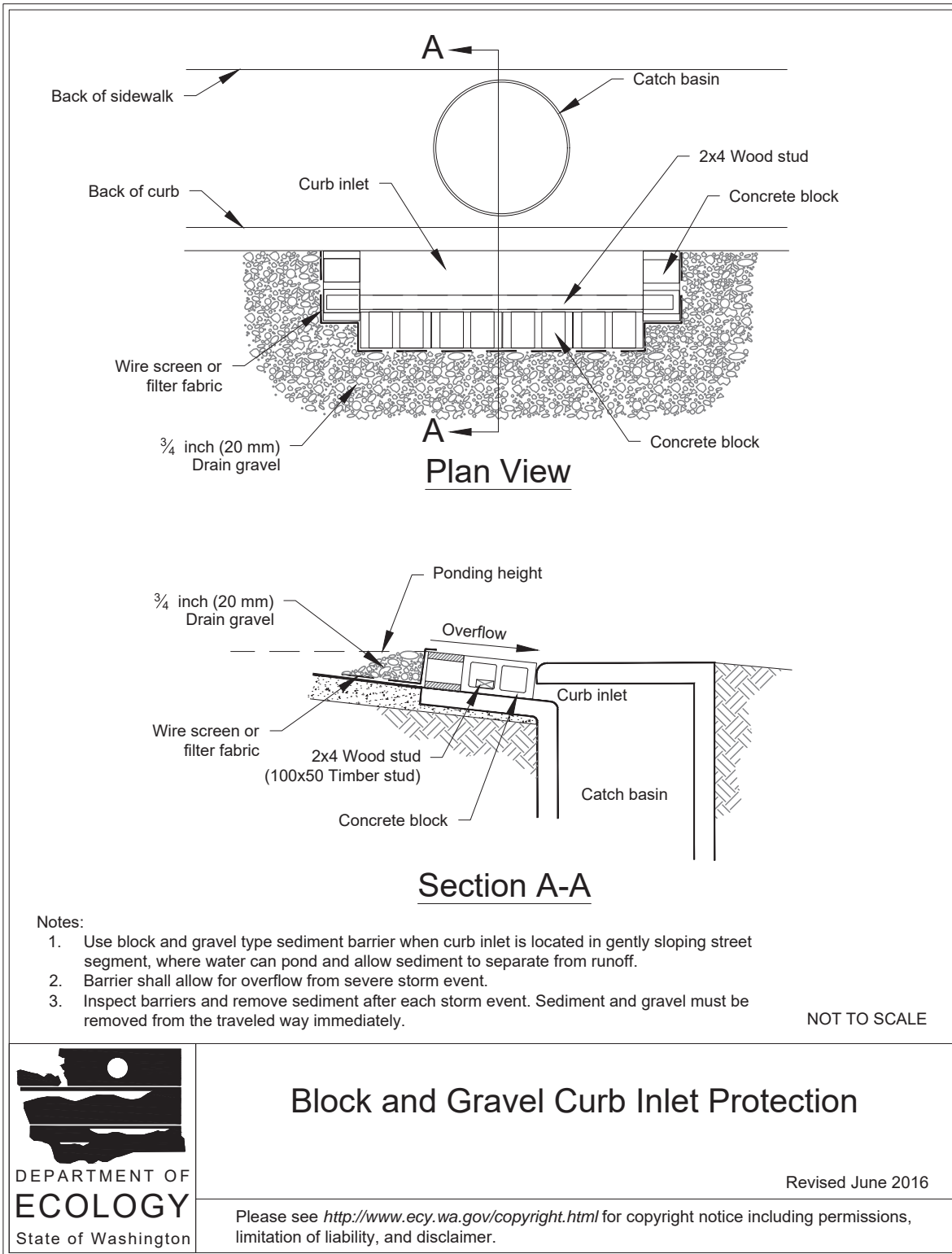
A curb and gutter sediment barrier is a sandbag or rock berm (riprap and aggregate) 3 feet high and 3 feet wide in a horseshoe shape. See [Figure 7.21: Curb and Gutter Barrier](#). Design and installation specifications for curb and sediment barriers include:

- Construct a horseshoe-shaped berm, faced with coarse aggregate if using riprap, 3 feet high and 3 feet wide,  $\geq 2$  feet from the inlet.
- Construct a horseshoe-shaped sedimentation trap on the upstream side of the berm. Size the trap to sediment trap standards for protecting a culvert inlet.

### ***Maintenance Standards***

- Inspect all forms of inlet protection frequently, especially after storm events. Clean and replace clogged catch basin filters. For rock and gravel filters, pull away the rocks from the inlet and clean or replace. An alternative approach is to use the clogged rock as fill and put fresh rock around the inlet.
- Do not wash sediment into storm drains while cleaning. Spread all excavated material evenly over the surrounding land area or stockpile and stabilize as appropriate.

**Figure 7.20: Block and Gravel Curb Inlet Protection**

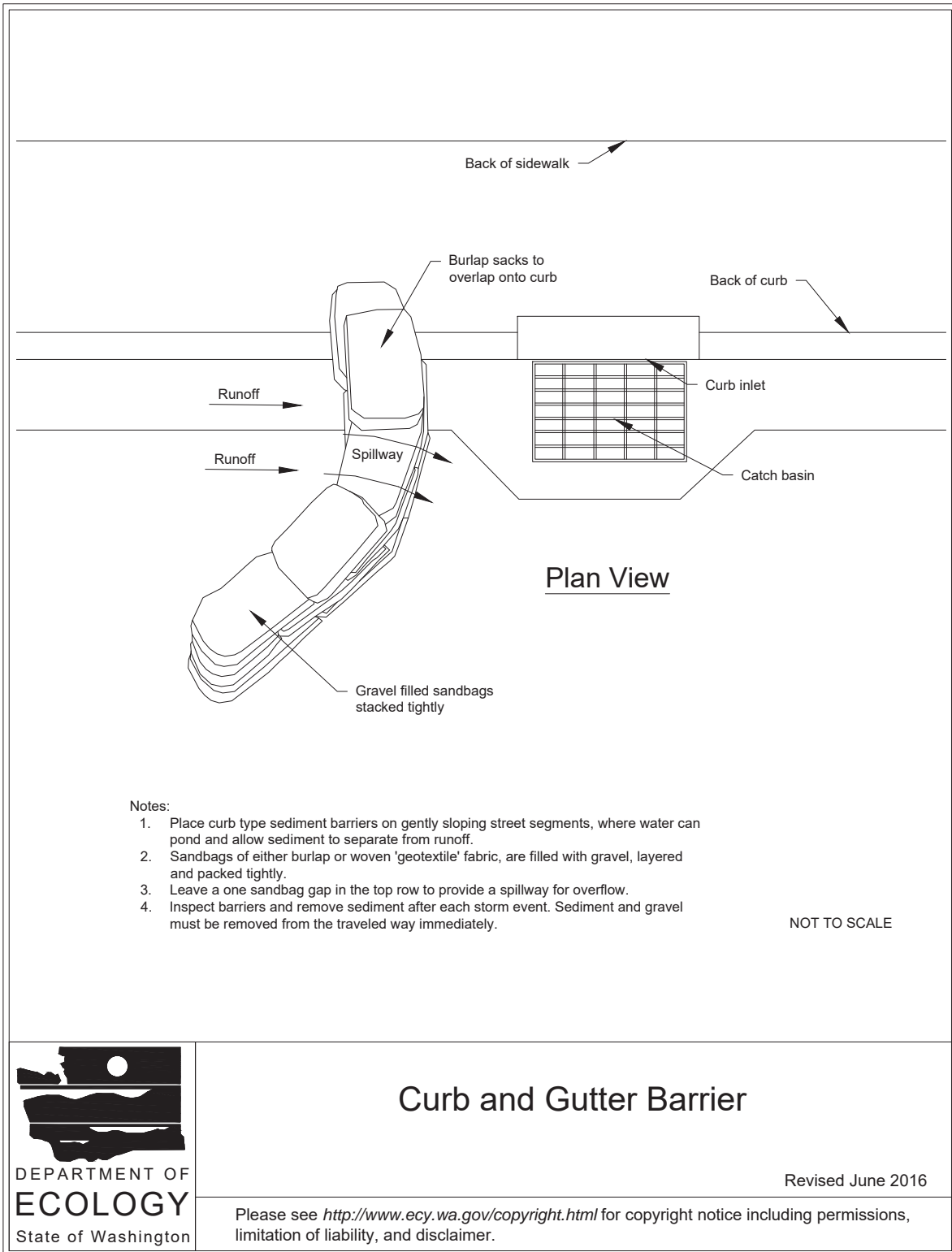


## Block and Gravel Curb Inlet Protection

Revised June 2016

Please see <http://www.ecy.wa.gov/copyright.html> for copyright notice including permissions, limitation of liability, and disclaimer.

**Figure 7.21: Curb and Gutter Barrier**



## ***Approved as Functionally Equivalent***

Ecology has approved products as able to meet the requirements of this BMP. The products did not pass through the Technology Assessment Protocol–Ecology (TAPE) process. Local jurisdictions may choose not to accept these products or may require additional testing prior to consideration for local use. Products that Ecology has approved as functionally equivalent are available for review on Ecology’s Emerging Stormwater Treatment Technologies (TAPE) web page at the following address:

<https://ecology.wa.gov/Regulations-Permits/Guidance-technical-assistance/Stormwater-permittee-guidance-resources/Emerging-stormwater-treatment-technologies>

## **BMP C231E: Brush Barrier**

### ***Purpose***

The purpose of brush barriers is to reduce the transport of coarse sediment from a construction site by providing a temporary physical barrier to sediment and reducing the runoff velocities of overland flow.

### ***Conditions of Use***

- Brush barriers may be used downslope of disturbed areas that are < 0.25 acres.
- Brush barriers are not intended to treat concentrated flows, nor are they intended to treat substantial amounts of overland flow. Any concentrated flows must be directed to a sediment-trapping BMP. The only circumstance in which overland flow can be treated solely by a brush barrier, rather than a sediment-trapping BMP, is when the area draining to the barrier is small.
- Brush barriers should only be installed on contours.

### ***Design and Installation Specifications***

- Height: 2 feet (minimum) to 5 feet (maximum).
- Width: 5 feet at base (minimum) to 15 feet (maximum).
- Geotextile may be anchored over the brush berm to enhance the filtration ability of the barrier. Use of 10-ounce burlap is an adequate alternative to geotextile.
- Chipped site vegetation, composted mulch, or wood-based mulch (hog fuel) is an acceptable material for constructing brush barriers.
- A 100% biodegradable installation can be constructed using 10-ounce burlap held in place by wooden stakes.
- See [Figure 7.22: Typical Brush Barrier](#).

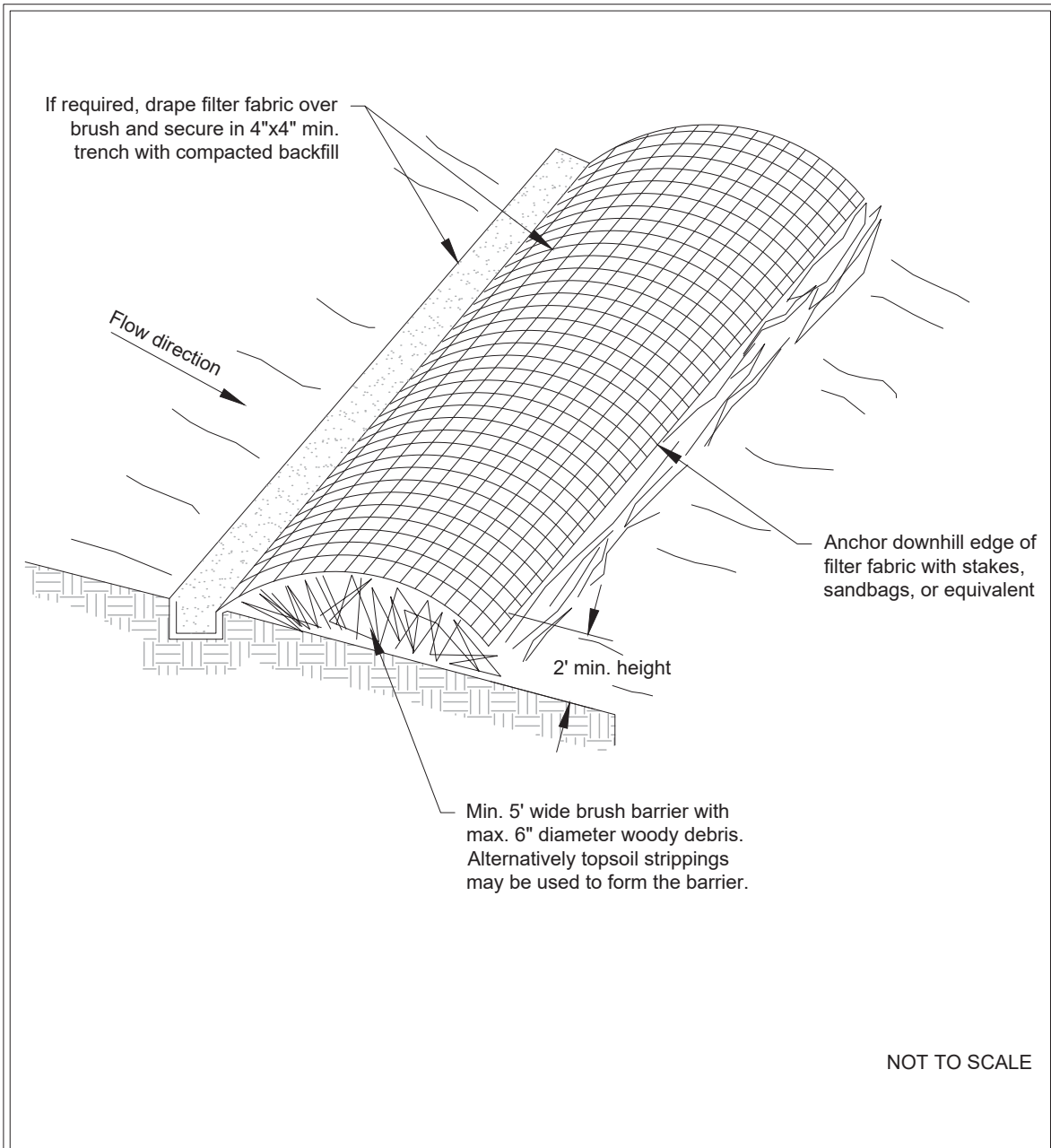
### ***Maintenance Standards***

- There shall be no signs of erosion or concentrated runoff under or around the barrier. If concentrated flows are bypassing the barrier, it must be expanded or augmented by toed-in

geotextile.

- The dimensions of the barrier must be maintained.

**Figure 7.22: Typical Brush Barrier**



## Typical Brush Barrier

Revised June 2016

Please see <http://www.ecy.wa.gov/copyright.html> for copyright notice including permissions, limitation of liability, and disclaimer.



## **BMP C232E: Gravel Filter Berm**

### ***Purpose***

A gravel filter berm retains sediment by filtering runoff through a berm of gravel or crushed rock.

### ***Conditions of Use***

- Use a gravel filter berm where a temporary measure is needed to retain sediment from construction sites.
- Do not place gravel filter berms in traffic areas; gravel filter berms are not intended to be driven over.
- Place gravel filter berms perpendicular to the flow of runoff, such that the runoff will filter through the berm prior to leaving the site.

### ***Design and Installation Specifications***

- Berm material shall be 0.75 to 3 inches in size, washed well-graded gravel, or crushed rock with < 5% fines. Do not use crushed concrete.
- Spacing of berms:
  - Every 300 feet on slopes < 5%
  - Every 200 feet on slopes between 5% and 10%
  - Every 100 feet on slopes > 10%
- Berm dimensions:
  - 1 foot high with 3H:1V side slopes
  - 8 linear feet per 1 cubic foot per second runoff based on the 10-year, 24-hour design storm
- See [Figure 7.23: Gravel Filter Berm](#).

### ***Maintenance Standards***

Regular inspection is required. Sediment shall be removed and filter material replaced as needed.

**Figure 7.23: Gravel Filter Berm**



### Gravel Filter Berm

Revised June 2016

Please see <http://www.ecy.wa.gov/copyright.html> for copyright notice including permissions, limitation of liability, and disclaimer.

## **BMP C233E: Silt Fence**

### ***Purpose***

Silt fence reduces the transport of coarse sediment from a construction site by providing a temporary physical barrier to sediment and reducing the runoff velocities of overland flow.

### ***Conditions of Use***

- Silt fence may be used downslope of all disturbed areas.
- Silt fence shall prevent sediment carried by runoff from going beneath, through, or over the top of the silt fence but shall allow the water to pass through the fence.
- Silt fence is not intended to treat concentrated flows, nor is it intended to treat substantial amounts of overland flow. Convey any concentrated flows through the drainage system to a sediment-trapping BMP.
- Do not construct silt fences in streams or use in V-shaped ditches. Silt fences do not provide an adequate method of silt control for anything deeper than sheet or overland flow.

### ***Design and Installation Specifications***

- Contributing area of  $\leq 1$  acre or in combination with sediment basin in a larger site.
- Use in combination with other construction stormwater BMPs.
- Maximum slope steepness (perpendicular to the silt fence line) of 1H:1V.
- Maximum sheet or overland flow path length to the silt fence of 100 feet.
- Do not allow flows  $> 0.5$  cubic feet per second.
- Use geotextile fabric that meets the standards indicated in [Table 7.19: Geotextile Fabric Standards for Silt Fence](#). All of the listed geotextile properties are minimum average roll values (i.e., the test result for any sampled roll in a lot shall meet or exceed the values shown in Table [Table 7.19: Geotextile Fabric Standards for Silt Fence](#)).

**Table 7.19: Geotextile Fabric Standards for Silt Fence**

Geotextile Property	Minimum Average Roll Value
Polymeric Mesh Apparent Opening Size (ASTM D4751)	0.60 mm maximum for slit film wovens (No. 30 sieve) 0.30 mm maximum for all other geotextile types (No. 50 sieve) 0.15 mm minimum for all fabric types (No. 100 sieve)
Water Permittivity (ASTM D4491)	0.02 sec-1 minimum
Grab Tensile Strength (ASTM D4632)	180 lb minimum for extra strength fabric 100 lb minimum for standard strength fabric
Grab Tensile Strength (ASTM D4632)	30% maximum
Ultraviolet Resistance (ASTM D4355)	70% minimum

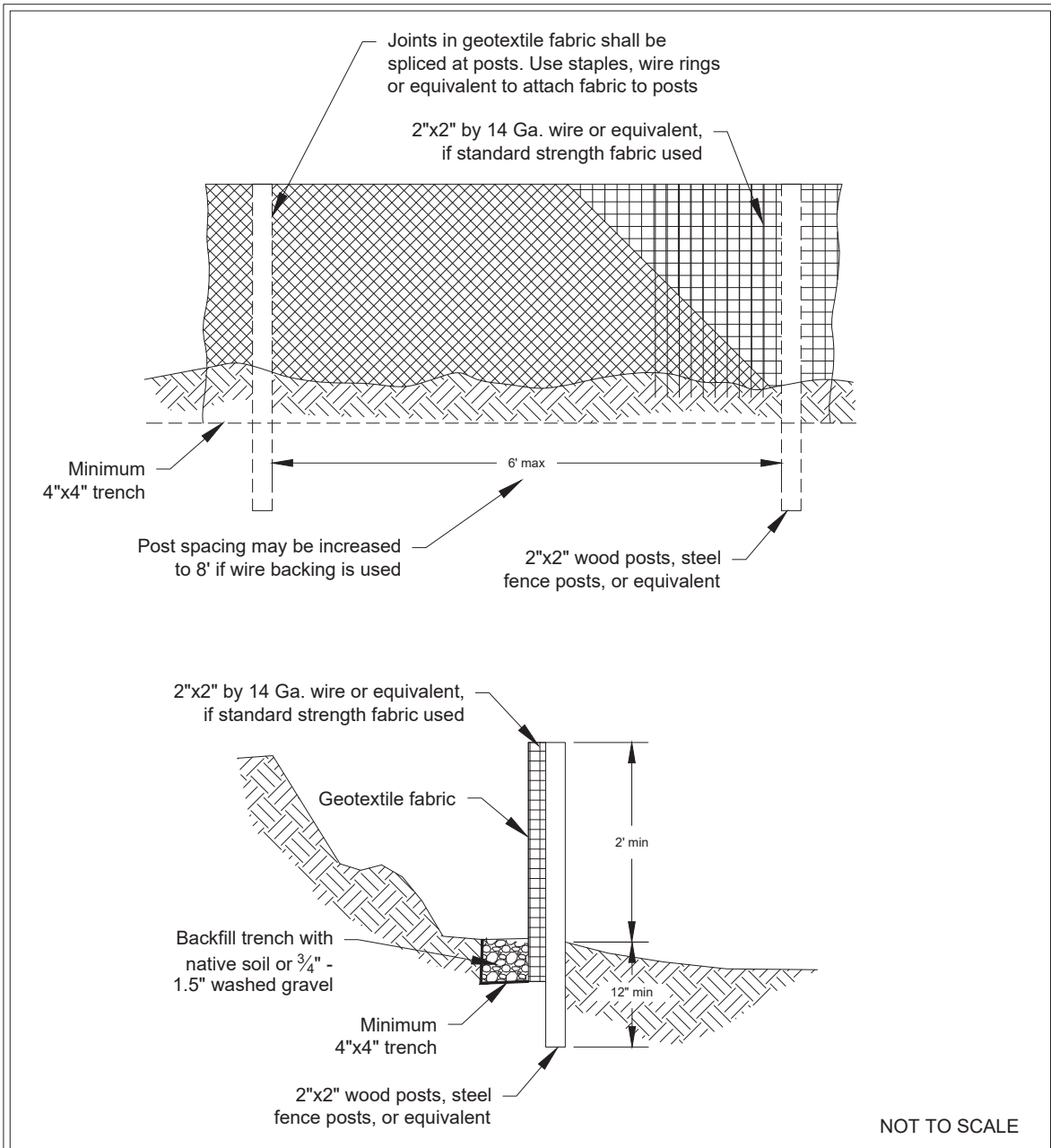
- Support standard strength geotextiles shall be supported with wire mesh, chicken wire, 2- by 2-inch wire, safety fence, or jute mesh to increase the strength of the geotextile Silt fence materials are available that have synthetic mesh backing attached.
- Silt fence material shall contain ultraviolet ray inhibitors and stabilizers to provide a minimum of 6 months of expected usable construction life at a temperature range of 0°F to 120°F.
- 100% biodegradable silt fence is available that is strong, long lasting, and can be left in place after the project is completed, if permitted by the local jurisdiction.
- See [Figure 7.24: Silt Fence](#). Include the following standard notes for silt fence on construction plans and specifications:
  1. The contractor shall install and maintain temporary silt fences at the locations shown in the plans.
  2. Construct silt fences in the areas of clearing, grading, or drainage prior to starting those activities.
  3. The silt fence shall have a 2-foot minimum and a 2.5-foot maximum height above the original ground surface.
  4. The geotextile fabric shall be sewn together at the point of manufacture to form fabric lengths as required. Locate all sewn seams at support posts. Alternatively, two sections of silt fence can be overlapped, provided the contractor can demonstrate, to the satisfaction of the licensed professional, that the overlap is long enough and that the adjacent silt fence sections are close enough together to prevent silt laden water from escaping through the fence at the overlap.
  5. Attach the geotextile fabric on the upslope side of the posts and secure with staples, wire, or in accordance with the manufacturer’s recommendations. Attach the geotextile fabric to the posts in a manner that reduces the potential for tearing.
  6. Support the geotextile fabric with wire or plastic mesh, dependent on the properties of

the geotextile selected for use. If wire or plastic mesh is used, fasten the mesh securely to the upslope of the posts with the geotextile fabric upslope of the mesh.

7. Mesh support, if used, shall consist of steel wire with a maximum mesh spacing of 2 inches, or a prefabricated polymeric mesh. The strength of the wire or polymeric mesh shall be  $\geq 180$  pounds grab tensile strength. The polymeric mesh must be as resistant to the same level of ultraviolet radiation as the geotextile fabric it supports.
8. Bury the bottom of the geotextile fabric 4 inches minimum below the ground surface. Backfill and tamp soil in place over the buried portion of the geotextile fabric, so that no flow can pass beneath the silt fence and scouring cannot occur. When wire or polymeric support mesh is used, the wire or polymeric mesh shall extend into the ground 3 inches minimum.
9. Drive or place the silt fence posts into the ground 18 inch minimum. A 12-inch minimum depth is allowed if topsoil or other soft subgrade soil is not present and 18 inches cannot be reached. Increase fence post minimum depths by 6 inches if the fence is located on slopes of  $\geq 3H:1V$  and the slope is perpendicular to the fence. If required post depths cannot be obtained, the posts shall be adequately secured by bracing or guying to prevent overturning of the fence due to sediment loading.
10. Use wood, steel or equivalent posts. The spacing of the support posts shall be a maximum of 6 feet. Posts shall consist of one of the following:
  - Wood with minimum dimensions of 2 inches by 2 inches by 3 feet. Wood shall be free of defects such as knots, splits, or gouges.
  - No. 6 steel rebar or larger.
  - ASTM A120 steel pipe with a minimum diameter of 1 inch.
  - U-, T-, L-, or C-shaped steel posts with a minimum weight of 1.35 pounds per foot.
  - Other steel posts having strength and bending resistance equivalent to the post sizes listed above.
11. Locate silt fences on contour as much as possible, except at the ends of the fence, where the fence shall be turned uphill such that the silt fence captures the runoff water and prevents water from flowing around the end of the fence.
12. If the fence must cross contours, with the exception of the ends of the fence, place check dams perpendicular to the back of the fence to minimize concentrated flow and erosion. The slope of the fence line where contours must be crossed shall be  $\leq 3H:1V$ .
  - Check dams shall be approximately 1 foot deep at the back of the fence and shall be continued perpendicular to the fence at the same elevation until the top of the check dam intercepts the ground surface behind the fence.
  - Check dams shall consist of crushed surfacing base course, gravel backfill for walls, or shoulder ballast and shall be located every 10 feet along the fence where the fence must cross contours.

- See [Figure 7.25: Silt Fence Installation by Slicing Method](#) for slicing method details. The following are specifications for silt fence installation using the slicing method:
  1. The base of both end posts must be  $\geq 2$  to 4 inches above the top of the geotextile fabric on the middle posts for ditch checks to drain properly. Use a hand level or string level, if necessary, to mark base points before installation.
  2. Install posts 3 to 4 feet apart in critical retention areas and 6 to 7 feet apart in standard applications.
  3. Install posts 24 inches deep on the downstream side of the silt fence, and as close as possible to the geotextile fabric, enabling posts to support the geotextile fabric from upstream water pressure.
  4. Install posts with the nipples facing away from the geotextile fabric.
  5. Attach the geotextile fabric to each post with three ties, all spaced within the top 8 inches of the fabric. Attach each tie diagonally 45 degrees through the fabric, with each puncture  $\geq 1$  inch vertically apart. Each tie should be positioned to hang on a post nipple when tightening to prevent sagging.
  6. Wrap approximately 6 inches of the geotextile fabric around the end posts and secure with three ties.
  7. No more than 24 inches of a 36-inch geotextile fabric is allowed above ground level.
  8. Compact the soil immediately next to the geotextile fabric with the front wheel of the tractor, skid steer, or roller exerting  $\geq 60$  pounds per square inch. Compact the upstream side first and then each side twice for a total of four trips. Check and correct the installation for any deviation before compaction. Use a flat-bladed shovel to tuck fabric deeper into the ground if necessary.

**Figure 7.24: Silt Fence**

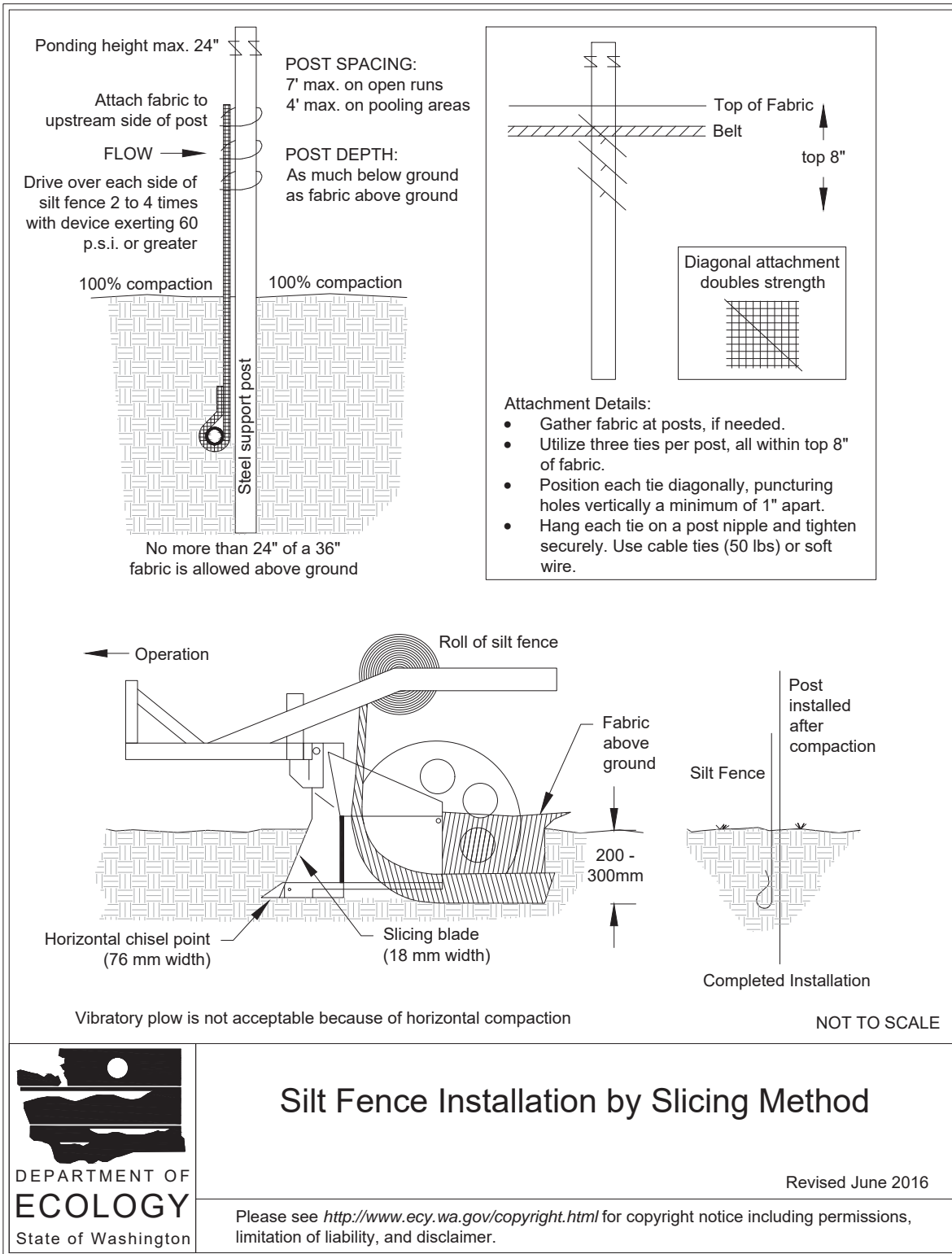


**Silt Fence**

Revised June 2016

Please see <http://www.ecy.wa.gov/copyright.html> for copyright notice including permissions, limitation of liability, and disclaimer.

**Figure 7.25: Silt Fence Installation by Slicing Method**





## Maintenance Standards

- Repair any damage immediately.
- If concentrated flows are evident uphill of the fence, they must be intercepted and conveyed to a sediment-trapping BMP.
- It is important to check the uphill side of the silt fence for signs of the fence clogging and acting as a barrier to flow and then causing channelization of flows parallel to the fence. If this occurs, replace the fence and remove the trapped sediment.
- Remove sediments deposits when the deposit reaches approximately one-third the height of the silt fence, or install a second silt fence.
- Replace geotextile fabric that has deteriorated due to ultraviolet breakdown.

## BMP C234E: Vegetated Strip

### Purpose

Vegetated strips reduce the transport of coarse sediment from a construction site by providing a physical barrier to sediment and reducing the runoff velocities of overland flow.

### Conditions of Use

- Vegetated strips may be used downslope of all disturbed areas.
- Vegetated strips are not intended to treat concentrated flows, nor are they intended to treat substantial amounts of overland flow. Any concentrated flows must be conveyed through the drainage system to [BMP C241E: Sediment Pond \(Temporary\)](#) or other sediment-trapping BMP. The only circumstance in which overland flow can be treated solely by a vegetated strip rather than a sediment-trapping BMP, is when the following criteria are met (see [Table 7.20: Contributing Area for Vegetated Strips](#)):

**Table 7.20: Contributing Area for Vegetated Strips**

Average Contributing Area Slope	Average Contributing Area Percentage Slope	Maximum Contributing Area Flow Path Length (feet)
≤ 1.5H:1V	≤ 67	100
≤ 2H:1V	≤ 50	115
≤ 4H:1V	≤ 25	150
≤ 6H:1V	≤ 16.7	200
≤ 10H:1V	≤ 10	250

### Design and Installation Specifications

- The vegetated strip shall consist of a continuous strip of dense vegetation with topsoil for a minimum length of 25 feet along the flow path. Grass-covered, landscaped areas are generally not adequate because the volume of sediment overwhelms the grass. Ideally,

vegetated strips shall consist of undisturbed native growth with a well-developed soil that allows for infiltration of runoff.

- The slope within the vegetated strip shall be  $\leq 4H:1V$ .
- The uphill boundary of the vegetated strip shall be delineated with clearing limits.

### **Maintenance Standards**

- Any areas damaged by erosion or construction activity shall be seeded immediately and protected by mulch.
- If  $> 5$  feet of the original vegetated strip width has had vegetation removed or is being eroded, sod must be installed.
- If there are indications that concentrated flows are traveling across the vegetated strip, stormwater runoff controls must be installed to reduce the flows entering the vegetated strip, or additional perimeter protection must be installed.

## **BMP C235E: Wattles**

### **Purpose**

Wattles are temporary erosion and sediment control barriers consisting of straw, compost, or other material that is wrapped in biodegradable tubular plastic or similar encasing material. They reduce the velocity and can spread the flow of rill and sheet runoff and can capture and retain sediment.

### **Conditions of Use**

- Use wattles under the following conditions:
  - In disturbed areas that require immediate erosion protection
  - On exposed soils during the period of short construction delays or over winter months
  - On slopes requiring stabilization until permanent vegetation can be established
- The material used dictates the effectiveness period of the wattle. Generally, wattles are effective for one to two seasons.
- Prevent rilling beneath wattles by entrenching and overlapping wattles to prevent water from passing between them.

### **Design Criteria**

- See [Figure 7.26: Wattles](#) for typical construction details.
- Wattles are typically 8 to 10 inches in diameter and 25 to 30 feet in length.
- Install wattles perpendicular to the flow direction and parallel to the slope contour.
- Place wattles in shallow trenches staked along the contour of disturbed or newly constructed slopes. Dig narrow trenches across the slope (on contour) to a depth of 3 to 5 inches on clay

soils and soils with gradual slopes. On loose soils, steep slopes, and areas with high rainfall, the trenches should be dug to a depth of 5 to 7 inches or one-half to two-thirds the thickness of the wattle.

- Start building trenches and installing wattles from the base of the slope and work up. Spread excavated material evenly along the uphill slope and compact it using hand tamping or other methods.
- Construct trenches at contour intervals of 3 to 30 feet apart depending on the steepness of the slope, soil type, and rainfall. The steeper the slope the closer together the trenches.
- Install the wattles snugly into the trenches and overlap the ends of adjacent wattles 12 inches behind one another.
- Install stakes at each end of the wattle and at 4-foot centers along entire length of wattle.
- If required, install pilot holes for the stakes using a straight bar to drive holes through the wattle and into the soil.
- Wooden stakes should be 0.75 by 0.75 by 24 inches minimum. Willow cuttings or 3/8-inch rebar can also be used for stakes.
- Stakes should be driven through the middle of the wattle, leaving 2 to 3 inches of the stake protruding above the wattle.

### ***Maintenance Standards***

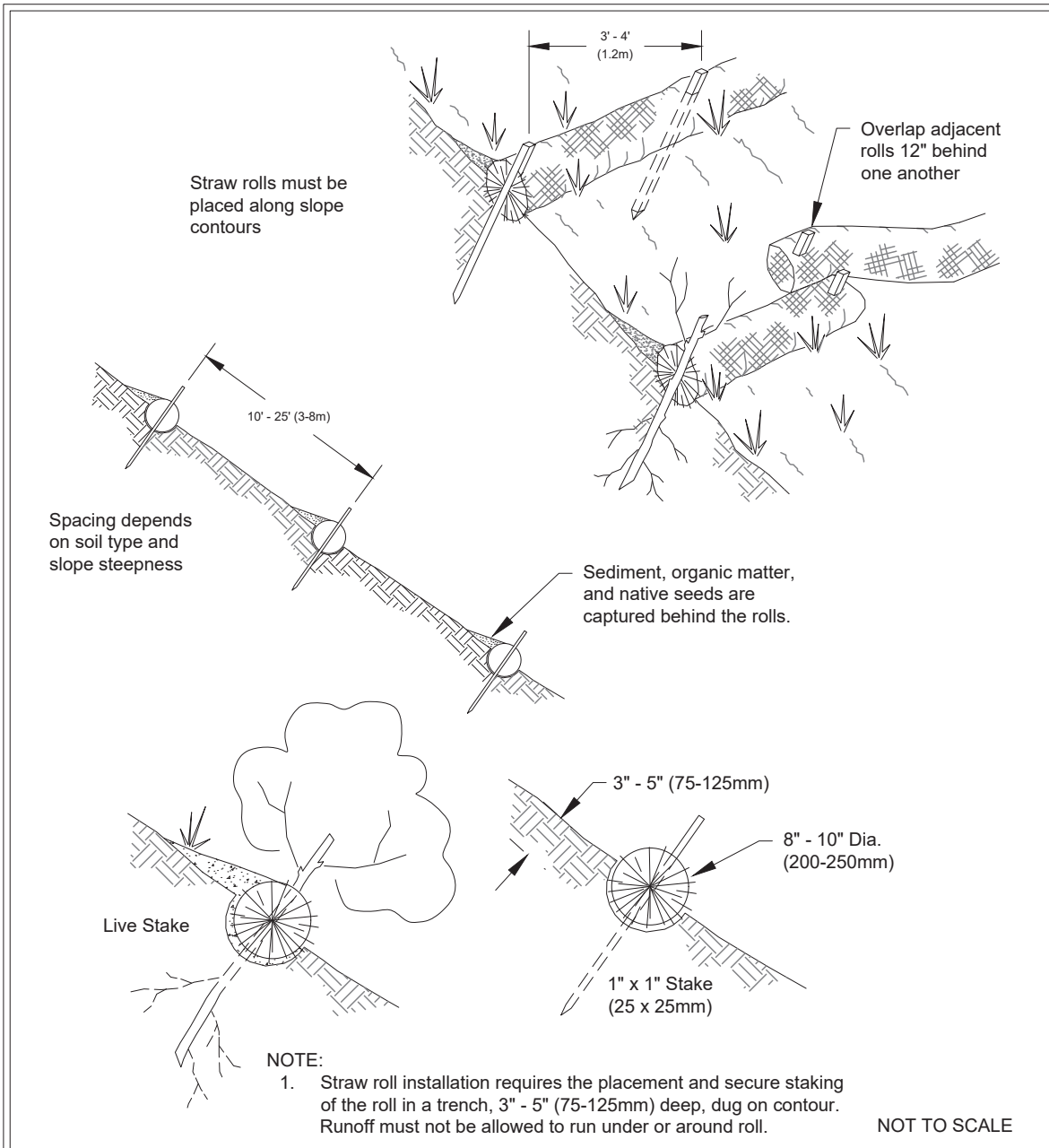
- Wattles may require maintenance to ensure they are in contact with soil and thoroughly entrenched, especially after significant rainfall on steep sandy soils.
- Inspect the slope after significant storms and repair any areas where wattles are not tightly abutted or water has scoured beneath the wattles.

### ***Approved as Functionally Equivalent***

The Washington State Department of Ecology (Ecology) has approved products as able to meet the requirements of this BMP. The products did not pass through the Technology Assessment Protocol–Ecology (TAPE) process. Local jurisdictions may choose not to accept these products or may require additional testing prior to consideration for local use. Products that Ecology has approved as functionally equivalent are available for review on Ecology’s Emerging Stormwater Treatment Technologies (TAPE) web page at the following address:

<https://ecology.wa.gov/Regulations-Permits/Guidance-technical-assistance/Stormwater-permittee-guidance-resources/Emerging-stormwater-treatment-technologies>

**Figure 7.26: Wattles**



## Wattles

Revised June 2016

Please see <http://www.ecy.wa.gov/copyright.html> for copyright notice including permissions, limitation of liability, and disclaimer.

## **BMP C236E: Vegetative Filtration**

### ***Purpose***

Vegetative filtration as a BMP is used in conjunction with [BMP C241E: Sediment Pond \(Temporary\)](#), [BMP C206E: Level Spreader](#), and a pumping system with surface intake. Vegetative filtration improves turbidity levels of stormwater discharges by filtering runoff through existing vegetation where undisturbed forest floor duff layer or established lawn with thatch layer are present. Vegetative filtration can also be used to infiltrate dewatering waste from foundations, vaults, and trenches as long as runoff does not occur.

### ***Conditions of Use***

- For every 5 acres of disturbed soil, use 1 acre of grass field, farm pasture, or wooded area. Reduce or increase this area depending on project size, ground water table height, and other site conditions.
- Wetlands shall not be used for vegetative filtration.
- Do not use this BMP in areas with a high ground water table or in areas that will have a high seasonal ground water table during the use of this BMP.
- This BMP may be less effective on soils that prevent the infiltration of the water, such as hard till.
- Using other effective source control measures throughout a construction site will prevent the generation of additional highly turbid water and may reduce the time period or area need for this BMP.
- Stop distributing water into the vegetated filtration area if standing water or erosion results.
- On large projects that phase the clearing of the site, areas retained with native vegetation may be used as a temporary vegetative filtration area.

### ***Design Criteria***

- Find land adjacent to the project site that has a vegetated field, preferably a farm field or wooded area.
- If the site does not contain enough vegetated field area, consider obtaining permission from adjacent landowners (especially for farm fields).
- Install a pump and downstream distribution manifold depending on the project size. Generally, the main distribution line should reach 100 to 200 feet long (large projects, or projects on tight soil, will require systems that reach several thousand feet long, with numerous branch lines off the main distribution line).
- The manifold should have several valves, allowing for control over the distribution area in the field.
- Install several branches of 4-inch-diameter Schedule 20 polyvinyl chloride (PVC), swaged-fit common septic tight-lined sewer line, or 6-inch-diameter fire hose, which can convey the

turbid water out to various sections of the field. See [Figure 7.27: Manifold and Branches in a Wooded, Vegetated Spray Field](#).

- Determine the branch length based on the field area geography and number of branches using [Table 7.21: Flow Path Guidelines for Vegetative Filtration](#). Typically, branches stretch from 200 feet to several thousand feet. Lay the branches on contour with the slope.
- On uneven ground, sprinklers perform well. Space sprinkler heads so that spray patterns do not overlap.
- On relatively even surfaces, a level spreader using 4-inch-diameter perforated pipe may be used as an alternative to the sprinkler head setup. Install drain pipe at the highest point on the field and at various lower elevations to ensure full coverage of the filtration area. Place the pipe with the holes up to allow for a gentle weeping evenly out all holes. Leveling the pipe by staking and using sandbags may be required.
- To prevent oversaturation of the vegetative filtration area, rotate the use of branches or spray heads. Repeat as needed based on monitoring of the spray field.

**Table 7.21: Flow Path Guidelines for Vegetative Filtration**

Average Slope	Average Area Percentage Slope	Estimated Flow Path Length (feet)
1.5H:1V	67	250
2H:1V	50	200
4H:1V	25	150
6H:1V	16.7	115
10H:1V	10	100

**Figure 7.27: Manifold and Branches in a Wooded, Vegetated Spray Field**



NOT TO SCALE



DEPARTMENT OF  
**ECOLOGY**  
State of Washington

### Manifold and Branches in a Wooded, Vegetated Spray Field

Revised June 2016

Please see <http://www.ecy.wa.gov/copyright.html> for copyright notice including permissions, limitation of liability, and disclaimer.

## **Maintenance Standards**

- Monitor the spray field on a daily basis to ensure that oversaturation of any portion of the field does not occur at any time. The presence of standing puddles of water or creation of concentrated flows visually signify that oversaturation of the field has occurred.
- Monitor the vegetated spray field all the way down to the nearest receiving water, or farthest spray area to ensure that the water has not caused overland or concentrated flows and has not created erosion around the spray nozzle(s).
- Do not exceed water quality standards for turbidity.
- The Washington State Department of Ecology (Ecology) recommends that a separate inspection log be developed, maintained, and kept with the existing site logbook to aid the operator who conducts inspections. This separate “Field Filtration Logbook” can also aid in demonstrating compliance with permit conditions.
- Inspect the spray nozzles daily, at a minimum, for leaks and plugging from sediment particles.
- If erosion, concentrated flows, or oversaturation of the field occurs, rotate the use of branches or spray heads or move the branches to a new field location.
- Check all branches and the manifold for unintended leaks.

## **BMP C240E: Sediment Trap**

### **Purpose**

A sediment trap is a small temporary ponding area with a gravel outlet used to collect and store sediment from sites during construction. Sediment traps, along with other perimeter controls, shall be installed before any land disturbance takes place in the contributing area.

### **Conditions of Use**

- Sediment traps are intended for use on sites where the contributing area is < 3 acres, with no unusual drainage features, and a projected build-out time of 6 months or less. The sediment trap is a temporary measure (with a design life of approximately 6 months) and shall be maintained until the tributary area is permanently protected against erosion by vegetation and/or structures.
- Sediment traps are effective in removing sediment only down to about the medium silt size fraction. Runoff with sediment of finer grades (fine silt and clay) will pass through untreated, emphasizing the need to control erosion to the maximum extent first.
- Projects that are constructing permanent flow control BMPs may use the rough-graded or final-graded permanent flow control BMP footprint for the temporary sediment trap. When permanent flow control BMP footprints are used as temporary sediment traps, the surface area requirement of the sediment trap must be met. If the surface area requirement of the sediment trap is larger than the surface area of the permanent flow control BMP, the sediment trap shall be enlarged beyond the permanent flow control BMP footprint to comply with the surface area requirement.



- A floating pond skimmer may be used for the sediment trap outlet if approved by the local permitting authority
- Sediment traps may not be feasible on utility projects due to the limited work space or the short-term nature of the work. Portable tanks may be used in place of sediment traps for utility projects.

### **Design and Installation Specifications**

- See [Figure 7.28: Cross-Section of Sediment Trap](#) and [Figure 7.29: Sediment Trap Outlet](#) for details.
- To determine the sediment trap geometry, first calculate the design surface area of the trap, measured at the invert of the weir, using the following equation:

#### **Equation 7.2: Sediment Trap Surface Area**

$$SA = FS * (Q_2/V_s)$$

where:

SA = design surface area of the trap (square feet [sf])

FS = A safety factor of 2 to account for nonideal settling

Q<sub>2</sub> = Peak volumetric flow rate (cubic feet [cf])

- Option 1 – single-event hydrograph method

Calculate Q<sub>2</sub> using a 10-minute time step for a 2-year, 24-hour frequency storm for the developed condition. The 10-year peak volumetric flow rate shall be used if the project size, expected timing and duration of construction, or downstream conditions warrant a higher level of protection.

- Option 2 – For construction sites < 1 acre, the Rational Method may be used to determine Q<sub>2</sub>.

V<sub>s</sub> = settling velocity of the soil particle of interest (feet per second [ft/sec])

The 0.02-millimeter (medium silt) particle with an assumed density of 2.65 grams per cubic centimeter has been selected as the particle of interest and has a settling velocity of 0.00096 ft/sec.

Therefore, the equation for computing sediment trap surface area becomes:

#### **Equation 7.3: Simplified Sediment Trap Surface Area**

$$SA = 2 \times Q_2 / 0.00096$$

or

2,080 sf per cubic foot per second (cfs) of inflow

where:

SA = design surface area of the trap (sf)

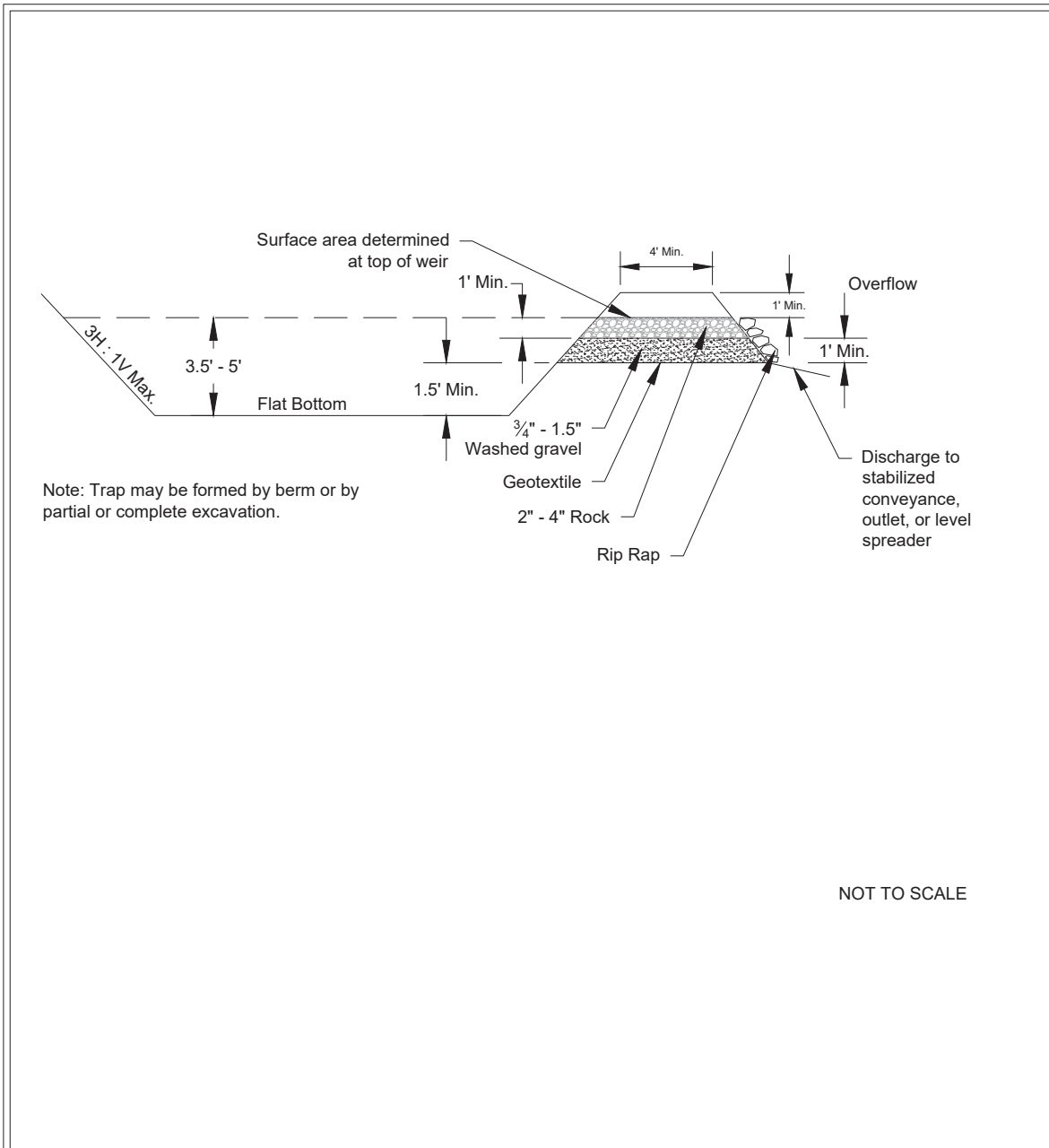
$Q_2$  = Peak volumetric flow rate (cf)

- Sediment trap depth shall be 3.5 feet minimum from the bottom of the trap to the top of the overflow weir.
- To aid in determining sediment depth, all sediment traps shall have a staff gauge with a prominent mark 1 foot above the bottom of the trap.
- Design the discharge from the sediment trap using the guidance for discharge from temporary sediment ponds in [BMP C241E: Sediment Pond \(Temporary\)](#).

### ***Maintenance Standards***

- Sediment shall be removed from the trap when it reaches 1 foot in depth.
- Any damage to the trap embankments or slopes shall be repaired.

**Figure 7.28: Cross-Section of Sediment Trap**

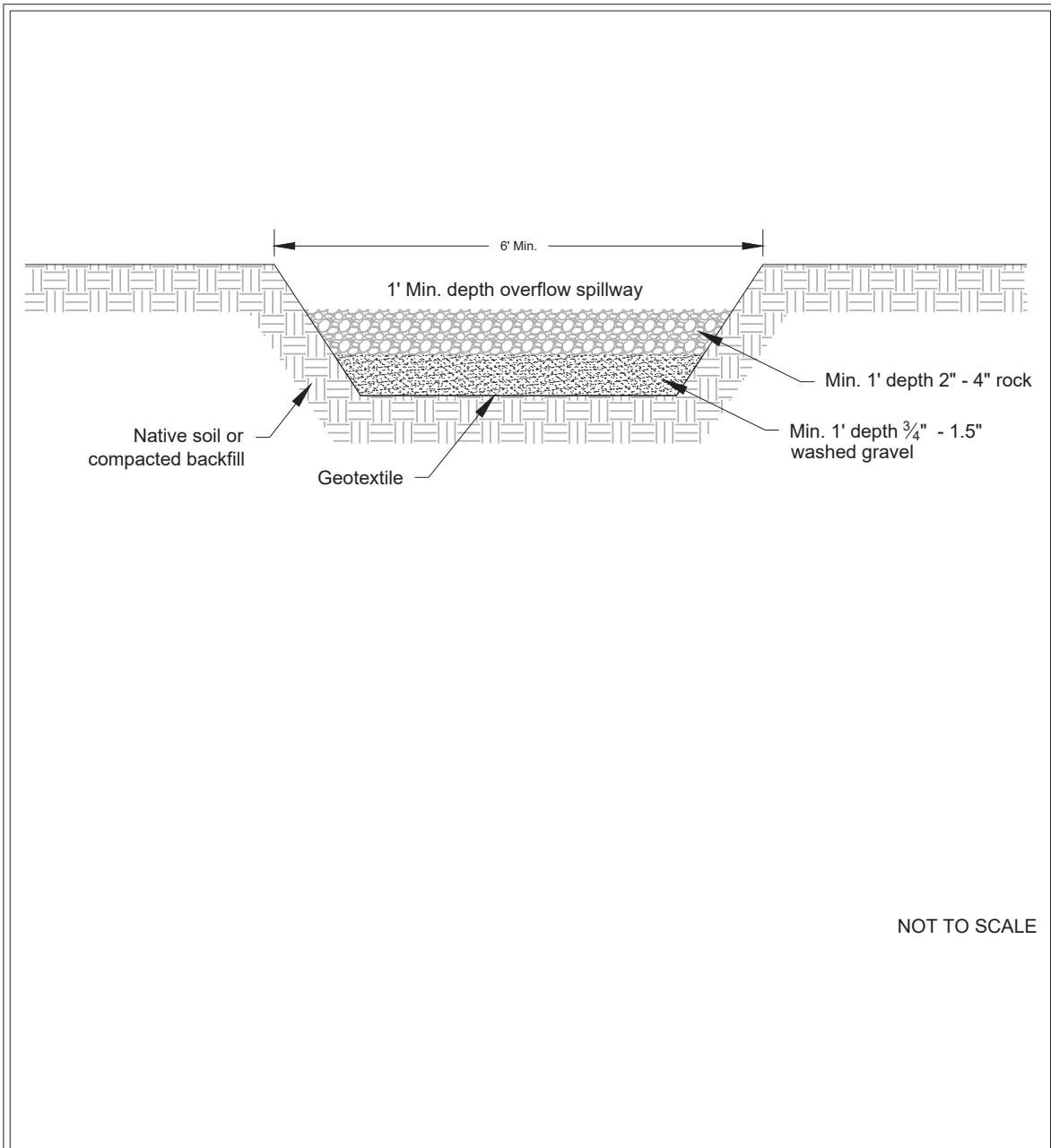


## Cross-Section of Sediment Trap

Revised June 2016

Please see <http://www.ecy.wa.gov/copyright.html> for copyright notice including permissions, limitation of liability, and disclaimer.

**Figure 7.29: Sediment Trap Outlet**



## Sediment Trap Outlet

Revised June 2016

Please see <http://www.ecy.wa.gov/copyright.html> for copyright notice including permissions, limitation of liability, and disclaimer.

## **BMP C241E: Sediment Pond (Temporary)**

### ***Purpose***

Sediment ponds are temporary ponds used during construction to remove sediment from runoff originating from disturbed areas of the site. Sediment ponds are typically designed to remove sediment no smaller than medium silt (0.02 millimeters). Consequently, they usually reduce turbidity only slightly.

### ***Conditions of Use***

- Use a sediment pond where the contributing area to the pond is  $\geq 3$  acres. Ponds must be used in conjunction with other construction stormwater BMPs to reduce the amount of sediment flowing into the pond.
- Do not install sediment ponds on sites where failure of the BMP would result in loss of life, damage to homes or buildings, or interruption of use or service of public roads or utilities. Also, sediment ponds are attractive to children and can be dangerous. Compliance with local ordinances regarding health and safety must be addressed. If fencing of the pond is required, show the type of fence and its location on the drawings in the Construction Stormwater Pollution Prevention Plan (SWPPP).
- Sediment ponds that can impound  $\geq 10$  acre-feet (435,600 cubic feet [cf]) or have an embankment height of  $> 6$  feet at the downstream toe, are subject to the Washington Dam Safety Regulations ([Chapter 173-175 WAC](#)). See [BMP F6.10: Detention Ponds](#) for more information regarding dam safety considerations for detention ponds.
- Projects that are constructing permanent flow control BMPs may use the rough-graded or final-graded permanent flow control BMP footprint for the temporary sediment pond. When permanent BMP footprints are used as temporary sediment ponds, the surface area requirement of the temporary sediment pond must be met. If the surface area requirement of the sediment pond is larger than the surface area of the permanent flow control BMP, then the sediment pond shall be enlarged beyond the permanent flow control BMP footprint to comply with the surface area requirement.

The permanent control structure must be temporarily replaced with a control structure that only allows water to leave the temporary sediment pond from the surface or by pumping. Alternatively, the permanent control structure may be used if it is temporarily modified by plugging any outlet holes below the riser. The permanent control structure must be installed as part of the permanent flow control BMP after the site is fully stabilized.

### ***Design and Installation Specifications***

#### **General**

- See [Figure 7.30: Sediment Pond Plan View](#), [Figure 7.31: Sediment Pond Cross Section](#), and [Figure 7.32: Sediment Pond Riser Detail](#) for details.
- Use of permanent infiltration BMP footprints for temporary sediment ponds during construction tends to clog the soils and reduce their capacity to infiltrate. If permanent

infiltration BMP footprints are used, the sides and bottom of the temporary sediment pond must only be rough excavated to a minimum of 2 feet above final grade of the permanent infiltration BMP. Final grading of the permanent infiltration BMP shall occur only when all contributing areas are fully stabilized. Any proposed permanent pretreatment BMP prior to the infiltration BMP should be fully constructed and used with the temporary sediment pond to help prevent clogging of the soils.

**For more information:** See [Element #13: Protect Low Impact Development BMPs \(Infiltration BMPs\)](#) for more information about protecting permanent infiltration BMPs.

- The pond shall be divided into two roughly equal-volume cells by a permeable divider that will reduce turbulence while allowing movement of water between the cells. The divider shall be  $\geq$  one-half the height of the riser, and  $\geq$  1 foot below the top of the riser. Wire-backed, 2- to 3-foot-high, high-strength geotextile fabric supported by treated 4x4s can be used as a divider. Alternatively, staked straw bales wrapped with geotextile fabric may be used. If the pond is  $>$  6 feet deep, a different divider design must be proposed. A riprap embankment is one acceptable method of separation for deeper ponds. Other designs that satisfy the intent of this provision are allowed as long as the divider is permeable, structurally sound, and designed to prevent erosion under or around the divider.
- The most common structural failure of sedimentation basins is caused by piping. Piping refers to two phenomena:
  1. water seeping through fine-grained soil, eroding the soil grain by grain and forming pipes or tunnels; and
  2. water under pressure flowing upward through a granular soil with a head of sufficient magnitude to cause soil grains to lose contact and capability for support.
- The most critical construction sequences to prevent piping are the following:
  - Tight connections between riser and outlet pipe, and other pipe connections
  - Adequate anchoring of riser
  - Proper soil compaction of the embankment and riser footing
  - Proper construction of antiseep devices

### **Sediment Pond Geometry**

To determine the sediment pond geometry, first calculate the surface area of the pond, measured at the top of the riser pipe, using the following equation:

#### **Equation 7.4: Pond Surface Area**

$$SA = 2 \times Q_2 / 0.00096$$

or

2,080 square feet (sf) per cubic foot per second (cfs) of inflow

where:

SA = design surface area of the trap (sf)

$Q_2$  = Peak volumetric flow rate (cf)

See [BMP C240E: Sediment Trap](#) for more information on [Equation 7.4: Pond Surface Area](#).

The basic geometry of the pond can now be determined using the following design criteria:

- Required surface area from [Equation 7.4: Pond Surface Area](#) at the top of the riser.
- Minimum 3.5-foot depth from the top of the riser to the bottom of the pond.
- Maximum 3H:1V interior side slopes and maximum 2H:1V exterior slopes. The interior slopes can be increased to a maximum of 2H:1V if fencing is provided at or above the maximum water surface.
- One foot of freeboard between the top of the riser and the crest of the emergency spillway.
- Flat bottom.
- Minimum 1-foot-deep spillway.
- Length-to-width ratio between 3:1 and 6:1.

### **Sediment Pond Discharge**

The outlet for the pond consists of a combination of principal and emergency spillways. These outlets must pass the peak runoff expected from the contributing area for a 100-year storm. If, due to site conditions and basin geometry, a separate emergency spillway is not feasible, the principal spillway must pass the entire peak runoff expected from the 100-year storm. However, an attempt to provide a separate emergency spillway should always be made. Base the runoff calculations on the site conditions during construction. The flow through the dewatering orifice cannot be used when calculating the 100-year storm elevation because of its potential to become clogged; therefore, available spillway storage must begin at the principal spillway riser crest.

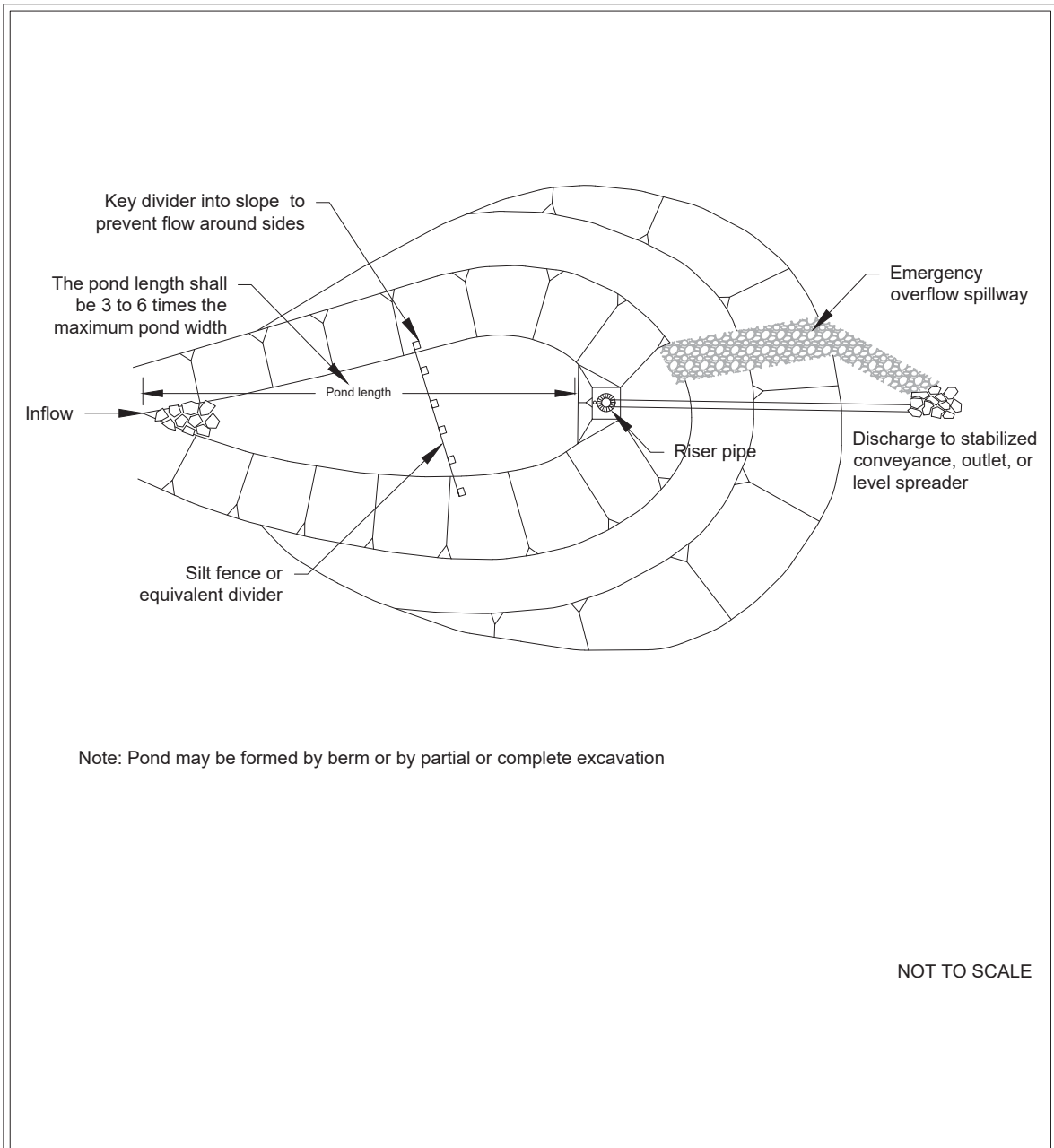
The principal spillway designed by the procedures will result in some reduction in the peak rate of runoff. However, the design will not control the basin discharge flow rates to the extent required to comply with [2.7.7 Core Element #6: Flow Control](#). The size of the contributing basin, the expected life of the construction project, the anticipated downstream effects, and the anticipated weather conditions during construction should be considered to determine the need for additional discharge control.

#### *Principal Spillway*

Determine the required diameter for the principal spillway (riser pipe). The diameter shall be the minimum necessary to pass the peak volumetric flow rate using a 10-minute time step for a 10-year, 24-hour frequency storm for the developed condition. Use [Figure 7.33: Riser Inflow Curves](#) to determine the riser diameter.

**Note:** To aid in determining sediment depth, 1-foot intervals should be prominently marked on the riser.

**Figure 7.30: Sediment Pond Plan View**



DEPARTMENT OF  
**ECOLOGY**  
State of Washington

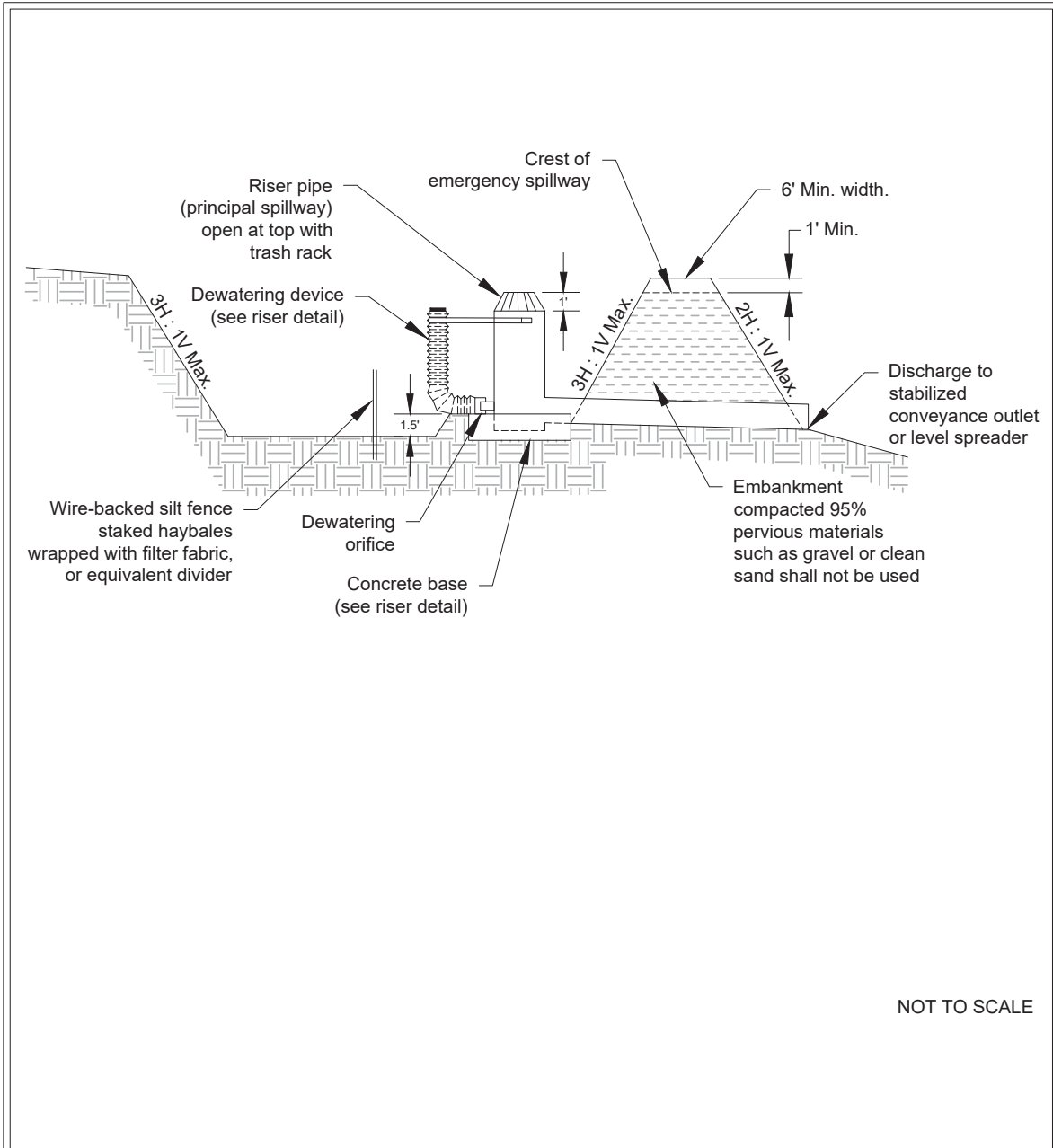
## Sediment Pond Plan View

Revised June 2016

Please see <http://www.ecy.wa.gov/copyright.html> for copyright notice including permissions, limitation of liability, and disclaimer.



**Figure 7.31: Sediment Pond Cross Section**



NOT TO SCALE

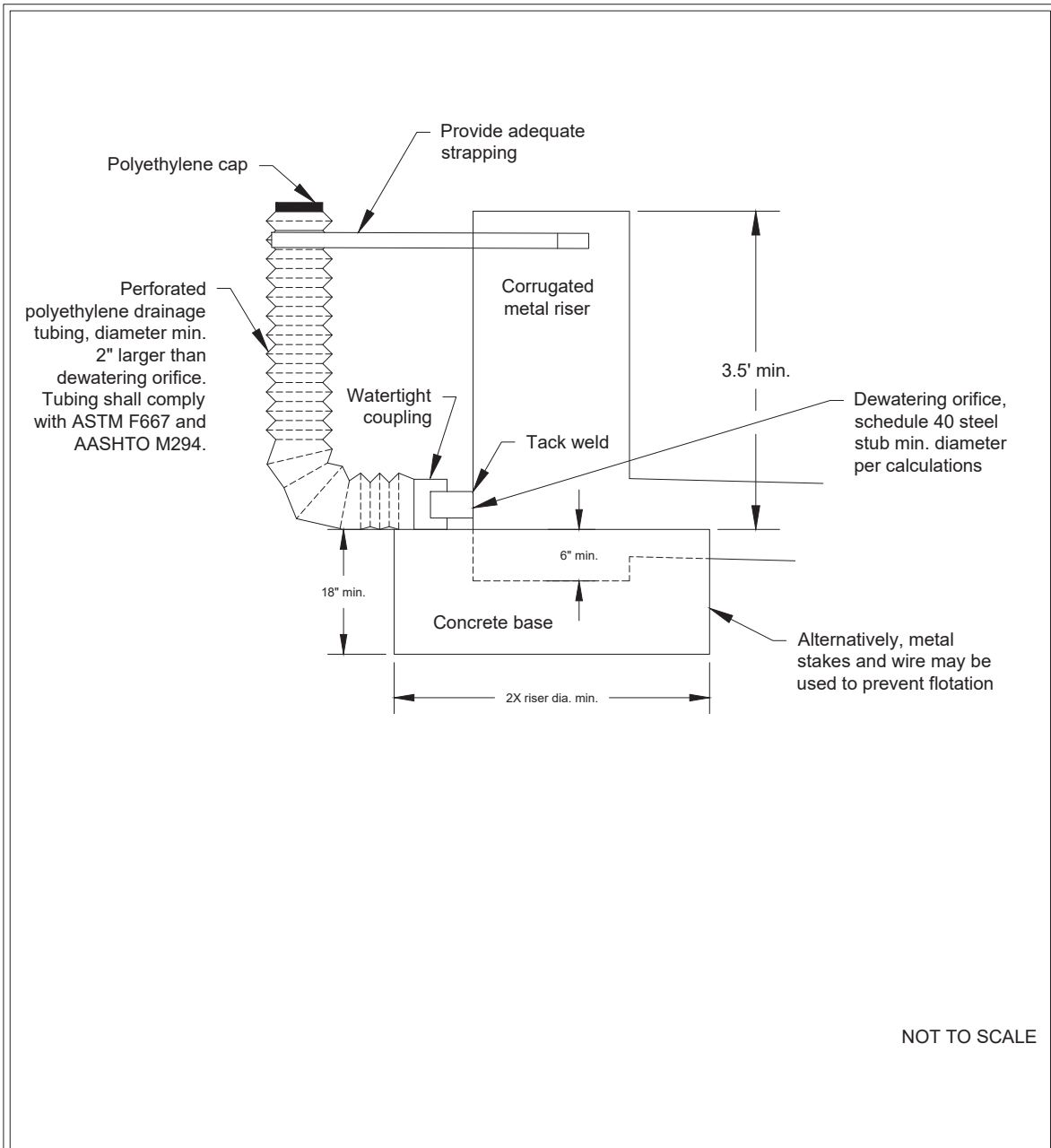


## Sediment Pond Cross Section

Revised June 2016

Please see <http://www.ecy.wa.gov/copyright.html> for copyright notice including permissions, limitation of liability, and disclaimer.

**Figure 7.32: Sediment Pond Riser Detail**



NOT TO SCALE

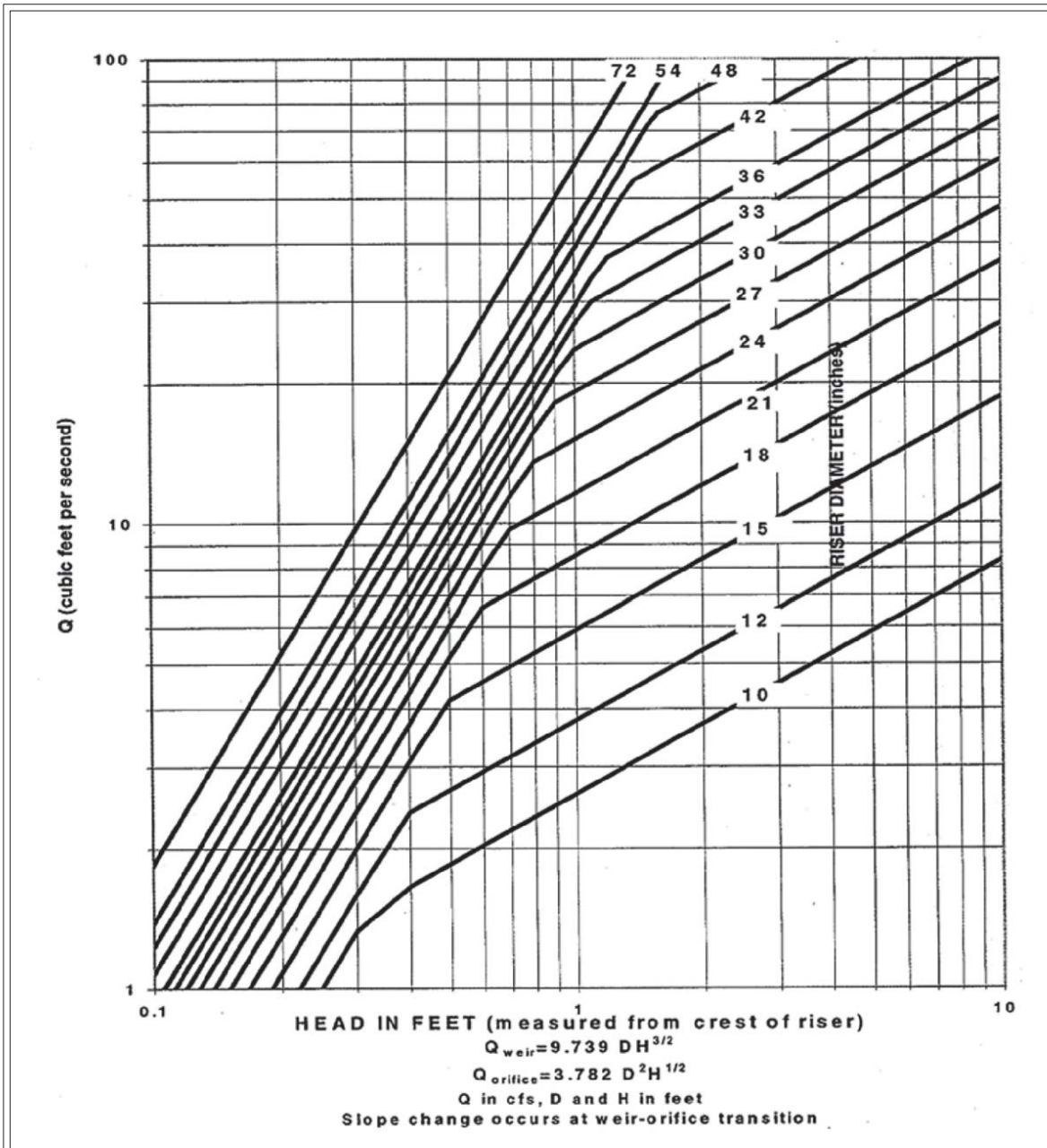


## Sediment Pond Riser Detail

Revised June 2016

Please see <http://www.ecy.wa.gov/copyright.html> for copyright notice including permissions, limitation of liability, and disclaimer.

**Figure 7.33: Riser Inflow Curves**



## Riser Inflow Curves

Revised June 2016

Please see <http://www.ecy.wa.gov/copyright.html> for copyright notice including permissions, limitation of liability, and disclaimer.

### *Emergency Overflow Spillway*

Size the emergency overflow spillway for the peak volumetric flow rate using a 10-minute time step from a Type 1A, 100-year, 24-hour frequency storm for the developed condition. See [BMP F6.10: Detention Ponds](#) for additional guidance for emergency overflow spillway design.

### *Dewatering Orifice*

Size the dewatering orifice(s) (minimum 1-inch-diameter) using a modified version of the discharge equation for a vertical orifice and a basic equation for the area of a circular orifice. Determine the required area of the orifice with the following equation:

#### **Equation 7.5: Dewatering Orifice Area**

$$A_o = \frac{A_s * (2h)^{0.5}}{0.6 * 3600 * T * g^{0.5}}$$

where:

$A_o$  = orifice area (sf)

$A_s$  = pond surface area (sf)

$h$  = head of water above orifice (height of riser) (feet)

$T$  = dewatering time (24 hours)

$g$  = acceleration of gravity (32.2 feet/second<sup>2</sup>)

Convert the orifice area to the orifice diameter (D):

#### **Equation 7.6: Dewatering Orifice Diameter**

$$D = 24 * \sqrt{\frac{A_o}{\pi}} = 13.54 * \sqrt{A_o}$$

where:

$D$  = orifice diameter (inches)

$A_o$  = orifice area (sf)

The vertical, perforated tubing connected to the dewatering orifice must be  $\geq 2$  inches larger in diameter than the orifice to improve flow characteristics. The size and number of perforations in the tubing should be large enough so that the tubing does not restrict flow. The orifice should control the flow rate.

### **Maintenance Standards**

- Remove sediment from the pond when it reaches 1 foot in depth.
- Repair any damage to the pond embankments or slopes.

## **BMP C250E: Construction Stormwater Chemical Treatment**

### ***Purpose***

This BMP applies when using stormwater chemicals in batch treatment or flow-through treatment.

Turbidity is difficult to control once fine particles are suspended in stormwater runoff from a construction site. [BMP C241E: Sediment Pond \(Temporary\)](#) is effective at removing larger particulate matter by gravity settling but is ineffective at removing smaller particulates such as clay and fine silt. Traditional construction stormwater BMPs may not be adequate to ensure compliance with the water quality standards for turbidity in the receiving water.

Chemical treatment can reliably provide exceptional reductions of turbidity and associated pollutants. Chemical treatment may be required to meet turbidity stormwater discharge requirements, especially when construction proceeds through the wet season.

### ***Conditions of Use***

Formal written approval from Ecology is required for the use of chemical treatment regardless of site size. See the Washington State Department of Ecology's (Ecology's) Request for Chemical Treatment form at the following web address:

<https://fortress.wa.gov/ecy/publications/SummaryPages/ecy070258.html>

The local jurisdiction may also require review and approval. When approved, the chemical treatment systems must be included in the Construction Stormwater Pollution Prevention Plan (SWPPP).

Chemically treated stormwater discharged from construction sites must be nontoxic to aquatic organisms. The Chemical Technology Assessment Protocol–Ecology (CTAPE) must be used to evaluate chemicals proposed for stormwater treatment. Only chemicals approved by Ecology under CTAPE may be used for stormwater treatment. The approved chemicals, their allowable application techniques (batch treatment or flow-through treatment), allowable application rates, and conditions of use can be found at Ecology's Emerging Stormwater Treatment Technologies (TAPE) web page at the following address:

<https://ecology.wa.gov/Regulations-Permits/Guidance-technical-assistance/Stormwater-permittee-guidance-resources/Emerging-stormwater-treatment-technologies>

### ***Background on Chemical Treatment Systems***

Coagulation and flocculation have been used for over a century to treat water. It is used less frequently for the treatment of wastewater. The use of coagulation and flocculation for treating stormwater is a very recent application. Experience with the treatment of water and wastewater has resulted in a basic understanding of the process, in particular factors that affect performance. This experience can provide insights as to how to most effectively design and operate similar systems in the treatment of stormwater.

Fine particles suspended in water give it a milky appearance, measured as turbidity. Their small size, often much less than 1 micron in diameter, give them a very large surface area relative to their volume. These fine particles typically carry a negative surface charge. Largely because of these two factors, small size and negative charge, these particles tend to stay in suspension for extended

periods of time. Thus, removal is not practical by gravity settling. These are called stable suspensions. Polymers, as well as inorganic chemicals such as aluminum sulfate (alum), speed the process of clarification. The added chemical destabilizes the suspension and causes the smaller particles to agglomerate. The process consists of three steps: coagulation, flocculation, and settling (or clarification). Ecology requires a fourth step, filtration, on all stormwater chemical treatment systems to reduce floc discharge and to provide monitoring prior to discharge.

## **General Design and Installation Specifications**

- Chemicals approved for use in Washington State are listed on Ecology's Emerging Stormwater Treatment Technologies (TAPE) web page under the "Construction" tab:  
<https://ecology.wa.gov/Regulations-Permits/Guidance-technical-assistance/Stormwater-permittee-guidance-resources/Emerging-stormwater-treatment-technologies>
- Care must be taken in the design of the withdrawal system to minimize outflow velocities and to prevent floc discharge. Stormwater that has been chemically treated must be filtered through [BMP C251E: Construction Stormwater Filtration](#) for filtration and monitoring prior to discharge.
- System discharge rates must take into account downstream conveyance integrity.
- The following equipment should be located on-site in a lockable shed:
  - The chemical injector
  - Secondary containment for acid, caustic, buffering compound, and treatment chemical
  - Emergency shower and eyewash
  - Monitoring equipment, which consists of a pH meter and a turbidimeter
- There are two types of systems for applying the chemical treatment process to stormwater: the batch chemical treatment system and the flow-through chemical treatment system. See subsequent text for further details of both types of systems.

### **Batch Chemical Treatment Systems**

A batch chemical treatment system consists of four steps: coagulation, flocculation, clarification, and polishing and monitoring by filtration.

#### **Step 1: Coagulation**

Coagulation is the process by which negative charges on the fine particles are disrupted. By disrupting the negative charges, the fine particles are able to flocculate. Chemical addition is one method of destabilizing the suspension, and polymers are one class of chemicals that are generally effective. Chemicals that are used for this purpose are called coagulants. Coagulation is complete when the suspension is destabilized by the neutralization of the negative charges. Coagulants perform best when they are thoroughly and evenly dispersed under relatively intense mixing. This rapid mixing involves adding the coagulant in a manner that promotes rapid dispersion, followed by a short time period for destabilization of the particle suspension. The particles are still very small and are not readily separated by clarification until flocculation occurs.

## **Step 2: Flocculation**

Flocculation is the process by which fine particles that have been destabilized bind together to form larger particles that settle rapidly. Flocculation begins naturally following coagulation but is enhanced by gentle mixing of the destabilized suspension. Gentle mixing helps to bring particles in contact with one another such that they bind and continually grow to form “flocs.” As the size of the flocs increases, they become heavier and settle.

## **Step 3: Clarification**

The final step is the settling of the particles, or clarification. Particle density, size and shape are important during settling. Dense, compact flocs settle more readily than less dense, fluffy flocs. Because of this, flocculation to form dense, compact flocs is particularly important during water treatment. Water temperature is important during settling. Both the density and viscosity of water are affected by temperature; these in turn affect settling. Cold temperatures increase viscosity and density, thus slowing down the rate at which the particles settle.

The conditions under which clarification is achieved can affect performance. Currents can affect settling. Currents can be produced by wind, by differences between the temperature of the incoming water and the water in the clarifier, and by flow conditions near the inlets and outlets. Quiescent water, such as that which occurs during batch clarification provides a good environment for effective performance as many of these factors become less important in comparison to typical sedimentation basins. One source of currents that is likely important in batch systems is movement of the water leaving the clarifier unit. Because flocs are relatively small and light, the velocity of the water must be as low as possible. Settled flocs can be resuspended and removed by fairly modest currents.

## **Step 4: Filtration**

After clarification, Ecology requires stormwater that has been chemically treated to be filtered and monitored prior to discharge. The sand filtration system continually monitors the stormwater effluent for turbidity and pH. If the discharge water is ever out of an acceptable range for turbidity or pH, the water is returned to the untreated stormwater pond where it will begin the treatment process again.

## **Design and Installation of Batch Chemical Treatment Systems**

A batch chemical treatment system consists of the stormwater collection system (either temporary diversion or the permanent site drainage system), a storage pond, pumps, a chemical feed system, treatment cells, and interconnecting piping.

The batch treatment system uses a storage pond for untreated stormwater followed by a minimum of two lined treatment cells. Multiple treatment cells allow for clarification of chemically treated water in one cell, while other cells are being filled or emptied. Treatment cells may be ponds or tanks. Ponds that impound > 10 acre-feet or have an embankment height of > 6 feet at the downstream toe are subject to the Washington Dam Safety Regulations ([Chapter 173-175 WAC](#)). See [BMP F6.10: Detention Ponds](#) for more information regarding dam safety considerations for ponds.

Stormwater is collected at interception point(s) on the site and is diverted by gravity or by pumping to an untreated stormwater storage pond or other untreated stormwater holding area. The stormwater is stored until treatment occurs. It is important that the storage pond be large enough to provide adequate storage.

The first step in the treatment sequence is to check the pH of the stormwater in the untreated stormwater storage pond. The pH is adjusted by the application of carbon dioxide or a base until the stormwater in the storage pond is within the desired pH range, 6.5 to 8.5. When used, carbon dioxide is added immediately downstream of the transfer pump. Typically sodium bicarbonate (baking soda) is used as a base, although other bases may be used. When needed, base is added directly to the untreated stormwater storage pond. The stormwater is recirculated with the treatment pump to provide mixing in the storage pond. Initial pH adjustments should be based on daily bench tests. Further pH adjustments can be made at any point in the process. See [BMP C252E: Treating and Disposing of High pH Water](#) for more information on pH adjustments as a part of chemical treatment.

Once the stormwater is within the desired pH range (which is dependent on the coagulant being used), the stormwater is pumped from the untreated stormwater storage pond to a lined treatment cell as a coagulant is added. The coagulant is added upstream of the pump to facilitate rapid mixing.

The water is kept in a lined treatment cell for clarification. In a batch mode process, clarification typically takes from 30 minutes to several hours. Prior to discharge, samples are withdrawn for analysis of pH, coagulant concentration, and turbidity. If these levels are acceptable, the treated water is withdrawn, filtered, and discharged.

Several configurations have been developed to withdraw treated water from the treatment cell. The original configuration is a device that withdraws the treated water from just beneath the water surface using a float with adjustable struts that prevent the float from settling on the cell bottom. This reduces the possibility of picking up sediment-floc from the bottom of the cell. The struts are usually set at a minimum clearance of about 12 inches; that is, the float will come within 12 inches of the bottom of the cell. Other systems have used vertical guides or cables which constrain the float, allowing it to drift up and down with the water level. More recent designs have an H-shaped array of pipes, set on the horizontal. This scheme provides for withdrawal from four points rather than one. This configuration reduces the likelihood of sucking settled solids from the bottom. It also reduces the tendency for a vortex to form. Inlet diffusers, a long floating or fixed pipe with many small holes in it, are also an option.

Safety is a primary concern. Design should consider the hazards associated with operations, such as sampling. Facilities should be designed to reduce slip hazards and drowning. Tanks and ponds should have life rings, ladders, or steps extending from the bottom to the top.

### **Sizing Batch Chemical Treatment Systems**

Chemical treatment systems must be designed to control the velocity and peak volumetric flow rate that is discharged from the system and consequently the project site. See Element #3 (Control Flow Rates) for further details on this requirement.

The total volume of the untreated stormwater storage pond and treatment cell must be large enough to treat stormwater that is produced during multiple day storm events. It is recommended that at a minimum the storage pond or other holding area should be sized to hold 1.5 times the volume of runoff generated from the site during the 10-year, 24-hour storm event. Bypass should be provided around the chemical treatment system to accommodate extreme storm events. Runoff volume shall be calculated using the methods presented in Chapter 4. If no hydrologic analysis is required for the site, the Rational Method may be used.



Primary settling should be encouraged in the untreated stormwater storage pond. A forebay with access for maintenance may be beneficial.

There are two opposing considerations in sizing the treatment cells. A larger cell is able to treat a larger volume of water each time a batch is processed. However, the larger the cell the longer the time required to empty the cell. A larger cell may also be less effective at flocculation and therefore require a longer settling time. The simplest approach to sizing the treatment cell is to multiply the allowable discharge flow rate (as determined by the guidance in [Element #3: Control Flow Rates](#)) times the desired drawdown time. A 4-hour drawdown time allows one batch per cell per 8-hour work period, given 1 hour of flocculation followed by 2 hours of settling.

**For more information:** See [BMP C251E: Construction Stormwater Filtration](#) for details on sizing the filtration system at the end of the batch chemical treatment system.

### **Background on Flow-Through Chemical Treatment Systems**

A flow-through chemical treatment system adds a sand filtration component to the batch chemical treatment system's treatment train following flocculation. The coagulant is added to the stormwater upstream of the sand filter so that the coagulation and flocculation step occur immediately prior to the filter. The advantage of a flow-through chemical treatment system is the time saved by immediately filtering the water, as opposed to waiting for the clarification process necessary in a batch chemical treatment system. See [BMP C251E: Construction Stormwater Filtration](#) for more information on filtration.

### **Design and Installation of Flow-Through Chemical Treatment Systems**

At a minimum, a flow-through chemical treatment system consists of the stormwater collection system (either temporary diversion or the permanent site drainage system), an untreated stormwater storage pond, and the chemically enhanced sand filtration system.

As with a batch treatment system, stormwater is collected at interception point(s) on the site and is diverted by gravity or by pumping to an untreated stormwater storage pond or other untreated stormwater holding area. The stormwater is stored until treatment occurs. It is important that the holding pond be large enough to provide adequate storage.

Stormwater is then pumped from the untreated stormwater storage pond to the chemically enhanced sand filtration system where polymer is added. Adjustments to pH may be necessary before chemical addition. The sand filtration system continually monitors the stormwater for turbidity and pH. If the discharge water is ever out of an acceptable range for turbidity or pH, the water is recycled to the untreated stormwater pond where it will begin the treatment process again.

### **Sizing Flow-Through Chemical Treatment Systems**

See [BMP C251E: Construction Stormwater Filtration](#) for sizing requirements of flow-through chemical treatment systems.

### **Factors Affecting the Chemical Treatment Process**

## Coagulants

Cationic polymers can be used as coagulants to destabilize negatively charged turbidity particles present in natural waters, wastewater and stormwater. Polymers are large organic molecules that are made up of subunits linked together in a chain-like structure. Attached to these chain-like structures are other groups that carry positive or negative charges, or have no charge. Polymers that carry groups with positive charges are called cationic, those with negative charges are called anionic, and those with no charge (neutral) are called nonionic. In practice, the only way to determine whether a polymer is effective for a specific application is to perform preliminary or on-site testing.

Alum can also be used as this chemical becomes positively charged when dispersed in water.

Polymers are available as powders, concentrated liquids, and emulsions (which appear as milky liquids). The latter are petroleum based, which are not allowed for construction stormwater treatment. Polymer effectiveness can degrade with time and also from other influences. Thus, manufacturers' recommendations for storage should be followed. Manufacturer's recommendations usually do not provide assurance of water quality protection or safety to aquatic organisms. Consideration of water quality protection is necessary in the selection and use of all polymers.

## Application

Application of coagulants at the appropriate concentration or dosage rate for optimum turbidity removal is important for management of chemical cost, for effective performance, and to avoid aquatic toxicity. The optimum dose in a given application depends on several site-specific features. Turbidity of untreated water can be important with turbidities > 5,000 nephelometric turbidity units (NTUs). The surface charge of particles to be removed is also important. Environmental factors that can influence dosage rate are water temperature, pH, and the presence of constituents that consume or otherwise affect polymer effectiveness. Laboratory experiments indicate that mixing previously settled sediment (floc sludge) with the untreated stormwater significantly improves clarification, therefore reducing the effective dosage rate. Preparation of working solutions and thorough dispersal of polymers in water to be treated is also important to establish the appropriate dosage rate.

For a given water sample, there is generally an optimum dosage rate that yields the lowest residual turbidity after settling. When dosage rates below this optimum value (underdosing) are applied, there is an insufficient quantity of coagulant to react with, and therefore destabilize, all of the turbidity present. The result is residual turbidity (after flocculation and settling) that is higher than with the optimum dose. Overdosing, application of dosage rates greater than the optimum value, can also adversely impact performance. Like underdosing, the result of overdosing is higher residual turbidity than that with the optimum dose.

## Mixing

The G-value, or just "G," is often used as a measure of the mixing intensity applied during coagulation and flocculation. The letter G stands for "velocity gradient," which is related in part to the degree of turbulence generated during mixing. High G-values mean high turbulence, and vice versa.

High G-values provide the best conditions for coagulant addition. With high G-values, turbulence is high and coagulants are rapidly dispersed to their appropriate concentrations for effective destabilization of particle suspensions.

Low G-values provide the best conditions for flocculation. Here, the goal is to promote formation of dense, compact flocs that will settle readily. Low G-values provide low turbulence to promote particle collisions so that flocs can form. Low G-values generate sufficient turbulence such that collisions are effective in floc formation but do not break up flocs that have already formed.

### **Adjustment of pH**

The pH must be in the proper range for the polymers to be effective, which is typically 6.5 to 8.5. As polymers tend to lower the pH, it is important that the stormwater have sufficient buffering capacity. Buffering capacity is a function of alkalinity. Without sufficient alkalinity, the application of the polymer may lower the pH to < 6.5. A pH < 6.5 not only reduces the effectiveness of the polymer as a coagulant, but it may also create a toxic condition for aquatic organisms. Stormwater may not be discharged without readjustment of the pH to > 6.5. The target pH should be within 0.2 standard units of the receiving water's pH.

Experience gained at several projects in the city of Redmond has shown that the alkalinity needs to be  $\geq 50$  milligrams per liter (mg/L) to prevent a drop in pH to < 6.5 when the polymer is added.

### **Maintenance Standards**

#### **Monitoring**

At a minimum, the following monitoring shall be conducted. Test results shall be recorded on a daily log kept on-site. Additional testing may be required by the Construction Stormwater General Permit (CSWGP) or the Phase II Municipal Stormwater National Pollutant Discharge Elimination System Permit for eastern Washington (Municipal Stormwater Permit) based on site conditions.

- Operational Monitoring:
  - Total volume treated and discharged
  - Continuous monitoring and recording of flow at intervals  $\leq 15$  minutes
  - Type and amount of chemical used for pH adjustment
  - Amount of polymer used for treatment
  - Settling time
- Compliance Monitoring:
  - Continuous monitoring and recording of influent and effluent pH, flocculent chemical concentration, and turbidity at intervals  $\leq 15$  minutes
  - The pH and turbidity of the receiving water
- Biomonitoring:
  - Treated stormwater must be nontoxic to aquatic organisms. Treated stormwater must be tested for aquatic toxicity or residual chemicals. Frequency of biomonitoring will be determined by Ecology.
  - Residual chemical tests must be approved by Ecology prior to their use.

- If testing treated stormwater for aquatic toxicity, it must be tested for acute (lethal) toxicity. Bioassays shall be conducted by a laboratory accredited by Ecology, unless otherwise approved by Ecology. Acute toxicity tests shall be conducted per CTAPE and Appendix G of *Whole Effluent Toxicity Testing Guidance and Test Review Criteria* ([Marshall, 2016](#)).

### **Discharge Compliance**

Prior to discharge, treated stormwater must be sampled and tested for compliance with the limits for pH, flocculent chemical concentration, and turbidity. These limits may be established by the CSWGP or a site-specific discharge permit. Sampling and testing for other pollutants may also be necessary at some sites. The pH reading must be within the range of 6.5 to 8.5 and not cause a change in the pH of the receiving water of > 0.2.

Treated stormwater samples and measurements shall be taken from the discharge pipe or another location representative of the nature of the treated stormwater discharge. Samples used for determining compliance with the water quality standards in the receiving water shall not be taken from the treatment pond prior to decanting. Compliance with the water quality standards is determined in the receiving water.

### **Operator Training**

Each site using chemical treatment must have an operator trained and certified by an organization approved by Ecology. For applications of chitosan-enhanced sand filtration (CESF), organizations approved for operator training are found on Ecology's web page for guidance on contaminated water on construction sites, under frequently asked questions at the following web address:

<https://ecology.wa.gov/Regulations-Permits/Guidance-technical-assistance/Stormwater-permittee-guidance-resources/Contaminated-water-on-construction-sites>

### **Sediment Removal and Disposal**

- Sediment shall be removed from the untreated stormwater storage pond and treatment cells as necessary. Typically, sediment removal is required at least once during a wet season and at the decommissioning of the chemical treatment system. Sediment remaining in the cells between batches may enhance the settling process and reduce the required chemical dosage.
- Sediment that is known to be nontoxic may be incorporated into the site away from drainages.

## **BMP C251E: Construction Stormwater Filtration**

### ***Purpose***

Filtration removes sediment from runoff originating from disturbed areas of the site.

### ***Conditions of Use***

Traditional construction stormwater BMPs used to control soil erosion and sediment loss from sites under development may not be adequate to ensure compliance with the water quality standard for

turbidity in the receiving water. Filtration may be used in conjunction with gravity settling to remove sediment as small as fine silt (0.5 microns). The reduction in turbidity will be dependent on the particle size distribution of the sediment in the stormwater. In some circumstances, sedimentation and filtration may achieve compliance with the water quality standard for turbidity.

The use of construction stormwater filtration does not require approval from the Washington State Department of Ecology (Ecology) as long as treatment chemicals are not used. Filtration in conjunction with [BMP C250E: Construction Stormwater Chemical Treatment](#) requires testing under the Chemical Technology Assessment Protocol–Ecology (CTAPE) before it can be initiated. Approval from the appropriate regional Ecology office must be obtained at each site where polymer use is proposed prior to its use. See Ecology’s Request for Chemical Treatment form at the following web address:

<https://fortress.wa.gov/ecy/publications/SummaryPages/ecy070258.html>

## ***Design and Installation Specifications***

Two types of filtration systems may be applied to construction stormwater treatment: rapid and slow.

Rapid filtration systems are the typical system used for water and wastewater treatment. They can achieve relatively high hydraulic flow rates, on the order of 2 to 20 gallons per minute per square foot (gpm/sf), because they have automatic backwash systems to remove accumulated solids.

Slow filtration systems have very low hydraulic rates, on the order of 0.02 gpm/sf, because they do not have backwash systems. Slow sand filtration has generally been used as a postconstruction BMP to treat stormwater (see filtration BMPs in [Chapter 5 - Runoff Treatment BMP Design](#)). Slow filtration is mechanically simple in comparison to rapid sand filtration but requires a much larger filter area.

### **Filtration Equipment**

Sand media filters are available with automatic backwashing features that can filter to a particle size of 50 microns. Screen or bag filters can filter down to 5 microns. Fiber wound filters can remove particles down to 0.5 microns. Filters should be sequenced from the largest to the smallest pore opening. Sediment removal efficiency will be related to particle size distribution in the stormwater.

### **Treatment Process and Description**

Stormwater is collected at interception point(s) on the site and diverted to a sediment pond or tank for removal of large sediment particles and storage of the stormwater before it is treated by the filtration system. In a rapid filtration system, the untreated stormwater is pumped from the trap, pond, or tank through the filtration media. Slow filtration systems are designed using gravity to convey water from the pond or tank through the filtration media.

### **Sizing**

Filtration treatment systems must be designed to control the velocity and peak volumetric flow rate that is discharged from the system and consequently the project site. See [Element #3: Control Flow Rates](#) for further details on this requirement.

The sediment pond or tank should be sized to hold 1.5 times the volume of runoff generated from the site during the 6-month, 3-hour storm for the developed condition, referred to as the short-duration storm, minus the filtration treatment system flow rate for an 8-hour period. For a chitosan-enhanced sand filtration system (CESF), the filtration treatment system flow rate should be sized using a hydraulic loading rate between 6 and 8 gpm/sf. Other hydraulic loading rates may be more appropriate for other systems. Bypass should be provided around the filtration treatment system to accommodate extreme storm events. Runoff volume shall be calculated using the methods presented in [Chapter 4 - Hydrologic Analysis and Design](#).

If the filtration treatment system design does not allow discharge at the rates required by [Element #3: Control Flow Rates](#) and if the site has a permanent flow control BMP that will serve the planned development, the discharge from the filtration treatment system may be directed to the permanent flow control BMP to comply with [Element #3: Control Flow Rates](#). In this case, all discharge (including water passing through the treatment system and stormwater bypassing the treatment system) will be directed into the permanent flow control BMP. If site constraints make locating the sediment pond or tank difficult, the permanent flow control BMP may be divided to serve as the sediment pond or tank and the posttreatment temporary flow control pond. In this case, a berm or barrier must be used to prevent the untreated water from mixing with the treated water. Both untreated stormwater storage requirements and adequate posttreatment flow control must be achieved. The designer must document in the Construction Stormwater Pollution Prevention Plan (SWPPP) how the permanent flow control BMP is able to attenuate the discharge from the site to meet the requirements of [Element #3: Control Flow Rates](#). If the design of the permanent flow control BMP was modified for temporary construction flow control purposes, the construction of the permanent flow control BMP must be finalized, as designed for its permanent function, at project completion.

### **Maintenance Standards**

- Rapid sand filters typically have automatic backwash systems that are triggered by a preset pressure drop across the filter. If the backwash water volume is not large or substantially more turbid than the untreated stormwater stored in the holding pond or tank, backwash return to the sediment pond or tank may be appropriate. However, other means of treatment and disposal may be necessary.
- Screen, bag, and fiber filters must be cleaned and/or replaced when they become clogged.
- Disposal of filtration equipment must comply with applicable local, state, and federal regulations.
- Sediment shall be removed from the sediment pond or tank as necessary. Typically, sediment removal is required once or twice during a wet season and at the decommissioning of the pond or tank.

## **BMP C252E: Treating and Disposing of High pH Water**

### **Purpose**

When pH levels in stormwater increase to >8.5, it is necessary to lower the pH levels to the acceptable range of 6.5 to 8.5 prior to discharge to surface or ground water. A pH range of 6.5 to 8.5 is typical for most natural receiving waters, and this neutral pH is required for the survival of aquatic

organisms. Should the pH deviate from this range, fish and other aquatic organisms may become stressed and may die.

### **Conditions of Use**

- The water quality standard for pH in Washington State is in the range of 6.5 to 8.5. Stormwater with pH levels exceeding water quality standards may be either neutralized on-site or disposed of in a sanitary sewer or concrete batch plant with pH neutralization capabilities.
- Neutralized stormwater may be discharged to receiving waters under the Construction Stormwater General Permit.
- Neutralized process water such as concrete truck washout, hydrodemolition, or sawcutting slurry must be managed to prevent discharge to receiving waters. Any stormwater contaminated during concrete work is considered process wastewater and must not be discharged to receiving waters or drainage systems.
- The process used for neutralizing and/or disposing of high pH stormwater from the site must be documented in the Construction Stormwater Pollution Prevention Plan (SWPPP).

### **Causes of High pH**

High pH at construction sites is most commonly caused by the contact of stormwater with poured or recycled concrete, cement, mortars, and other Portland cement or lime containing construction materials. (See [BMP C151E: Concrete Handling](#) for more information on concrete-handling procedures.) The principal caustic agent in cement is calcium hydroxide (free lime).

Calcium hardness can contribute to high pH values and cause toxicity that is associated with high pH conditions. A high level of calcium hardness in waters of the state is not allowed. Ground water standard for calcium and other dissolved solids in Washington State is < 500 milligrams per liter (mg/L).

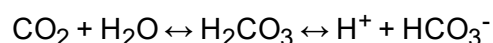
### **Treating High pH Stormwater by Carbon Dioxide Sparging**

#### *Advantages of Carbon Dioxide Sparging*

- Rapidly neutralizes water with a high pH.
- Cost effective and safer to handle than acid compounds.
- Carbon dioxide (CO<sub>2</sub>) is self-buffering. It is difficult to overdose and create harmfully low pH levels.
- Material is readily available.

#### *Chemical Process of Carbon Dioxide Sparging*

When CO<sub>2</sub> is added to water (H<sub>2</sub>O), carbonic acid (H<sub>2</sub>CO<sub>3</sub>) is formed, which can further dissociate into a proton (H<sup>+</sup>) and a bicarbonate anion (HCO<sub>3</sub><sup>-</sup>) as shown:



The free proton is a weak acid that can reduce the pH. Water temperature has an effect on the reaction as well. The colder the water temperature is, the slower the reaction. The warmer the water temperature is, the quicker the reaction. Most construction applications in Washington State have water temperatures of  $\geq 50^{\circ}\text{F}$ ; therefore, the reaction is almost simultaneous.

### *Treatment Process of Carbon Dioxide Sparging*

High pH water may be treated using continuous treatment, continuous discharge systems. These manufactured systems continuously monitor influent and effluent pH to ensure that pH values are within an acceptable range before being discharged. All systems must have fail-safe automatic shutoff switches in the event that pH is not within the acceptable discharge range. Only trained operators may operate manufactured systems. System manufacturers often provide trained operators or training on their devices.

The following procedure may be used when not using a continuous discharge system:

1. Prior to treatment, the appropriate jurisdiction should be notified in accordance with the regulations set by the jurisdiction.
2. Every effort should be made to isolate the potential high pH water in order to treat it separately from other stormwater on-site.
3. Water should be stored in an acceptable storage facility, detention pond, or containment cell prior to pH treatment.
4. Transfer water to be treated for pH to the pH treatment structure. Ensure that the pH treatment structure size is sufficient to hold the amount of water that is to be treated. Do not fill the pH treatment structure completely; allow  $\geq 2$  feet of freeboard.
5. The operator samples the water within the pH treatment structure for pH and notes the clarity of the water. As a rule of thumb, less  $\text{CO}_2$  is necessary for clearer water. The results of the samples and water clarity observations should be recorded.
6. In the pH treatment structure, add  $\text{CO}_2$  until the pH falls into the range of 6.9 to 7.1. Adjusting pH to within 0.2 standard units of receiving water (background pH) is recommended. It is unlikely that pH can be adjusted to within 0.2 standard units using dry ice. Compressed  $\text{CO}_2$  gas should be introduced to the water using a  $\text{CO}_2$  diffuser located near the bottom of the pH treatment structure, this will allow  $\text{CO}_2$  to bubble up through the water and diffuse more evenly.
7. Slowly discharge the water, making sure water does not get stirred up in the process. Release about 80% of the water from the pH treatment structure, leaving any sludge behind. If turbidity remains above the maximum allowable, consider adding filtration to the treatment train. See [BMP C251E: Construction Stormwater Filtration](#).
8. Discharge treated water through a pond or drainage system.
9. Excess sludge needs to be disposed of properly as concrete waste. If several batches of water are undergoing pH treatment, sludge can be left in the treatment structure for the next batch treatment. Dispose of sludge when it fills 50% of the treatment structure volume. Disposal must comply with applicable local, state, and federal regulations.



## **Treating High pH Stormwater by Food-Grade Vinegar**

Food-grade vinegar that meets Food and Drug Administration standards may be used to neutralize high pH water. Food-grade vinegar is only 4% to 18% acetic acid with the remainder being water. Food-grade vinegar may be used if the dose is just enough to lower pH sufficiently. Use a treatment process as described above for CO<sub>2</sub> sparging, but add food-grade vinegar instead of CO<sub>2</sub>.

This treatment option for high pH stormwater does not apply to anything but food-grade vinegar. Acetic acid does not equal vinegar. Any other product or waste containing acetic acid must go through the evaluation process in Appendix G of *Whole Effluent Toxicity Testing Guidance and Test Review Criteria* ([Marshall, 2016](#)).

## **Disposal of High pH Stormwater**

### *Sanitary Sewer Disposal*

- Local sewer authority approval is required prior to disposal via the sanitary sewer.

### *Concrete Batch Plant Disposal*

- Only permitted facilities may accept high pH water.
- Contact the facility to ensure it can accept the high pH water.

## ***Maintenance Standards***

### **Safety and Materials Handling**

- All equipment should be handled in accordance with Occupational Safety and Health Administration (OSHA) rules and regulations.
- Follow manufacturer's guidelines for materials handling.

Each operator should provide the following:

- A diagram of the monitoring and treatment equipment
- A description of the pumping rates and capacity the treatment equipment is capable of treating

Each operator should keep a written record of the following:

- Client name and phone number
- Date of treatment
- Weather conditions
- Project name and location
- Volume of water treated
- pH of untreated water
- Amount of CO<sub>2</sub> or food-grade vinegar needed to adjust water to a pH range of 6.9 to 7.1

- pH of treated water
- Discharge point location and description

A copy of this record should be given to the client/contractor, who should retain the record for 3 years.

## **Appendix 7-A: Recommended Standard Notes for Construction SWPPP Drawings**

The standard notes provided in this appendix are suggested for use in Construction Stormwater Pollution Prevention Plans (SWPPPs) also referred to as erosion and sediment control (ESC) plans. Local jurisdictions may have other mandatory notes that are applicable. Drawings should also identify, with phone numbers, the person or firm responsible for the preparation of and maintenance of the Construction SWPPP drawings.

The following are recommended as standard notes for Construction SWPPP drawings:

- Approval of this ESC plan does not constitute an approval of permanent road or drainage design (e.g., size and location of roads, pipes, restrictors, channels, retention facilities, utilities, etc.).
- The implementation of this ESC plan and the construction, maintenance, replacement, and upgrading of these ESC BMPs is the responsibility of the applicant until all construction is completed and approved and vegetation/landscaping is established.
- Clearly flag the boundaries of the clearing limits shown on this plan in the field prior to construction. During the construction period, no disturbance beyond the flagged clearing limits shall be permitted. The flagging shall be maintained by the applicant for the duration of construction.
- Construct the ESC BMPs shown on this plan in conjunction with all clearing and grading activities, and in such a manner as to ensure that sediment and sediment laden water do not enter the drainage system, roadways, or violate applicable water standards.
- The ESC BMPs shown on this plan are the minimum requirements for anticipated site conditions. During the construction period, upgrade these ESC BMPs as needed for unexpected storm events and to ensure that sediment and sediment-laden water do not leave the site.
- The applicant shall inspect the ESC BMPs daily and maintain them as necessary to ensure their continued functionality.
- Inspect and maintain the ESC BMPs on inactive sites a minimum of once a month or within the 48 hours following a major storm event (24-hour storm event with a 10-year or greater recurrence interval).
- At no time shall the sediment exceed 60 percent of the sump depth or have less than 6 inches of clearance from the sediment surface to the invert of the lowest pipe. All catch basins and conveyance lines shall be cleaned prior to paving. The cleaning operation shall not flush sediment laden water into the downstream system.
- Install stabilized construction entrances at the beginning of construction and maintain for the duration of the project. Additional measures may be required to ensure that all paved areas are kept clean for the duration of the project.

*This page has been intentionally left blank for double-sided printing.*

# Chapter 8 - Source Control

## 8.1 Introduction

### 8.1.1 Purpose

This chapter provides guidance for selecting source control Best Management Practices (BMPs) to meet [2.7.4 Core Element #3: Source Control of Pollution](#).

BMPs are schedules of activities, prohibitions of practices, maintenance procedures, and structural and/or managerial practices that when used singly or in combination, prevent or reduce the release of pollutants and other adverse impacts on waters of Washington State. BMPs can be used singularly or in combination.

Facilities covered under the Washington State Department of Ecology's (Ecology's) Industrial Stormwater General Permit (ISGP), Boatyard General Permit, or Sand and Gravel General Permit should also consult this chapter to identify applicable and recommended operational and structural BMPs. All three permits require permittees to develop and implement Stormwater Pollution Prevention Plans (SWPPPs). Industrial SWPPPs and Boatyard SWPPPs must include operational source control BMPs and source control BMPs listed as "applicable" in this chapter.

Applying the source control BMPs in this chapter can also help local jurisdictions and businesses to control urban sources of pollutants in stormwater (see [Appendix 8-C: Stormwater Pollutants and Their Adverse Impacts](#)) and aid them in meeting state water quality standards to protect beneficial uses of receiving waters.

Local jurisdictions may require commercial, industrial, and multifamily properties to implement the source control BMPs in this chapter through ordinances or other documents. Operators of these property types should check with the local jurisdiction regarding local requirements related to source control BMPs and SWPPPs

### 8.1.2 Content and Organization of This Chapter

This chapter consists of two sections and three appendices:

- [8.1 Introduction](#) serves as an introduction and provides descriptions of operational and structural source control BMPs. It distinguishes between applicable BMPs and recommended BMPs and describes the relationship between the source control BMPs in this chapter and regulatory requirements.
- [8.2 Selection of Operational and Structural Source Control BMPs](#) presents operational and structural BMPs designed to address specific types of pollutant sources.
  - [8.2.2 Source Control BMPs Applicable to All Sites](#) presents source control BMPs that are applicable to all sites.
  - [8.2.3 Pollutant Source-Specific BMPs](#) presents pollutant source-specific BMPs, which are typically structural BMPs.

- [Appendix 8-A: Urban Land Uses and Pollution-Generating Sources](#) identifies pollution-generating sources at various land uses.
- [Appendix 8-B: Management of Street Waste Solids and Liquids](#) presents BMPs for managing street waste.
- [Appendix 8-C: Stormwater Pollutants and Their Adverse Impacts](#) identifies stormwater pollutants and their adverse impacts.

### 8.1.3 Operational and Structural Source Control BMPs

There are two categories of source control BMPs: operational and structural.

Operational source control BMPs are nonstructural practices that prevent or reduce pollutants from entering stormwater. Examples include formation of a pollution prevention team, good housekeeping practices, preventive maintenance procedures, spill prevention and cleanup, employee training, inspections of pollutant sources, and record keeping. They can also include process changes, raw material/product changes, and recycling wastes. [8.2 Selection of Operational and Structural Source Control BMPs](#) contains a general discussion of operational source controls that are frequently used.

Most stormwater experts consider operational source control BMPs the most cost-effective practice to reduce pollution.

Structural source control BMPs are physical, structural, or mechanical devices intended to prevent pollutants from entering stormwater. Examples of structural source control BMPs typically include the following:

- Enclosing and/or covering the pollutant source (e.g., within a building or other enclosure, a roof over storage and working areas, or temporary tarpaulin)
- Physically segregating the pollutant source to prevent run-on of uncontaminated stormwater
- Devices that direct contaminated stormwater to appropriate runoff treatment BMPs (e.g., discharge to a sanitary sewer if allowed by the local jurisdiction)

### 8.1.4 Runoff Treatment BMPs for Specific Pollutant Sources

This chapter also identifies specific runoff treatment BMPs that apply to specific pollutant sources, such as fueling stations, railroad yards, and material storage and transfer areas.

Runoff treatment BMPs are intended to remove pollutants from stormwater. Examples include settling basins or vaults, oil and water separators, biofiltration swales, filter strips, wetponds, constructed wetlands, infiltration systems, and emerging technologies.

Facilities required to install additional runoff treatment BMPs to comply with Ecology's ISGP (or other Stormwater General Permits) should consider the runoff treatment BMPs identified in [Chapter 5 - Runoff Treatment BMP Design](#) when selecting and designing runoff treatment BMPs. In addition, facilities should consider the source control, runoff conveyance, and treatment BMPs in [Chapter 7 - Construction Stormwater Pollution Prevention](#) if turbidity and/or sediment reduction is required.

## **8.1.5 Distinction Between Applicable BMPs and Recommended BMPs**

This chapter uses the terminology “applicable BMPs” and “recommended BMPs” to address an important distinction. This section explains the use of these terms.

### ***Applicable BMPs***

The National Pollutant Discharge Elimination System (NPDES) Stormwater General Permits for municipal, industrial, and construction stormwater discharges require the adoption or use of Ecology’s *Stormwater Management Manual for Eastern Washington* (manual) or an equivalent manual.

BMPs identified in this chapter, as applicable, must be included in local jurisdiction manuals to be considered equivalent to this manual. Ecology expects local jurisdictions to require those BMPs described as applicable at new development and redevelopment sites.

Local jurisdictions may require commercial, industrial, and multifamily properties to implement the source control BMPs in this chapter through ordinances or other documents. Operators of these property types should check with the local jurisdiction regarding local requirements related to source control BMPs and SWPPPs.

All sites covered under the ISGP must include and implement the applicable BMPs in their Industrial SWPPP.

Industrial sites covered by individual industrial stormwater permits must comply with the specific source control and runoff treatment BMPs listed in their permits. Operators under individual industrial stormwater permits may include additional BMPs from this manual, if desired.

All sites covered under the Boatyard General Permit must include and implement the applicable BMPs in their Boatyard SWPPP.

Facilities covered under the Sand and Gravel General Permit must include source control BMPs as necessary in their Sand and Gravel SWPPP to achieve all known, available, and reasonable methods of prevention, control, and treatment (AKART) and compliance with the stormwater discharge limits in their permit.

Other facilities that are not required by an NPDES Stormwater General Permit or local jurisdiction to use the BMPs described in this chapter are encouraged to implement both applicable and recommended BMPs.

Regulatory programs such as that associated with the State Environmental Policy Act, water quality certification under Section 401 of the Clean Water Act, and Hydraulic Project Approvals (HPAs) may require use of the BMPs described in this chapter.

### ***Recommended BMPs***

Ecology offers these recommended BMPs as approaches that go beyond or complement the applicable BMPs. Implementing the recommended BMPs may improve control of pollutants and provide a more comprehensive and environmentally effective stormwater management program.

Ecology encourages all operators to review their SWPPPs and use recommended BMPs where possible.

Facilities covered under the ISGP that trigger a corrective action should consider implementing one or more recommended BMPs as a means to fulfill their corrective action requirements and achieve benchmark values.

## **8.2 Selection of Operational and Structural Source Control BMPs**

### **8.2.1 Introduction**

Urban stormwater pollutant sources include manufacturing and commercial areas; high-use vehicle parking lots; material (including wastes) storage and handling; vehicle/equipment fueling, washing, maintenance, and repair areas; erodible soil; streets/highways; and the handling/application of deicing chemicals and lawn care products.

Operators can achieve reduction or elimination of stormwater pollutants by implementing “operational source control Best Management Practices (BMPs). Operational source control BMPs include formation of a pollution prevention team, good housekeeping practices, preventive maintenance procedures, spill prevention and cleanup, employee training, regular inspections, and record keeping. These BMPs can be combined with impervious containments and covers, i.e., structural source control BMPs. If operational and structural source control BMPs are not feasible or adequate, then runoff treatment BMPs will be necessary.

The Washington State Department of Ecology’s Industrial Stormwater General Permit (ISGP), Boatyard General Permit, and Sand and Gravel General Permit require the use of the BMPs described in this chapter in Stormwater Pollution Prevention Plans (SWPPPs). Local jurisdictions may also require the use of the BMPs described in this chapter. See [8.1.5 Distinction Between Applicable BMPs and Recommended BMPs](#) for more information regarding the applicable use of BMPs in SWPPPs.

Under the ISGP, if a facility’s sampling triggers Level 1 or Level 2 Corrective Action requirements, operators should consider the recommended operational (Level 1) and structural (Level 2) source control BMPs to fulfill permit requirements and reduce pollutant concentrations.

Base the initial selection of source control BMPs on land use and the pollution-generating sources. Appendix 8A describes various land uses, activities and the potential pollutant-generating sources associated with those activities. The BMPs described herein may also be applicable for land uses not listed in [Appendix 8-A: Urban Land Uses and Pollution-Generating Sources](#).

For example, if a commercial printing business conducts weed control with herbicides, loading and unloading of materials, and vehicle washing, it should see the following subsections in [8.2.3 Pollutant Source-Specific BMPs](#) for these activities:

- [S404E: BMPs for Commercial Printing Operations](#)
- [S411E: BMPs for Landscaping and Lawn/Vegetation Management](#)



- [S412E: BMPs for Loading and Unloading Areas for Liquid or Solid Material](#)
- [S431E: BMPs for Washing and Steam Cleaning Vehicles/Equipment/Building Structures](#)

Operators under the ISGP or Boatyard General Permit should take special care to review this chapter in its entirety to ensure that all of the applicable source control BMPs are included within their industrial or boatyard SWPPP (regardless of the listings in [Appendix 8-A: Urban Land Uses and Pollution-Generating Sources](#)).

**For more information:** See [8.1.5 Distinction Between Applicable BMPs and Recommended BMPs](#) to determine which BMPs are required for inclusion in your SWPPP.

## **8.2.2 Source Control BMPs Applicable to All Sites**

### **Introduction**

Where required by local code or by a NPDES Stormwater General Permit, implement the applicable source control BMPs at:

- Commercial properties,
- Industrial properties,
- Multifamily properties,
- Boatyards, and
- Sand and gravel mining operations.

### ***BMPs in this Section***

- [S101E: BMPs for Formation of a Pollution Prevention Team](#)
- [S102E: BMPs for Preventive Maintenance/Good Housekeeping](#)
- [S104E: BMPs for Spill Prevention and Cleanup](#)
- [S105E: BMPs for Employee Training](#)
- [S106E: BMPs for Inspections](#)
- [S107E: BMPs for Record Keeping](#)
- [S108E: BMPs for Correcting Illicit Connections to Storm Drains](#)

### **S101E: BMPs for Formation of a Pollution Prevention Team**

The pollution prevention team should be responsible for implementing and maintaining all BMPs and treatment for the site. This team should be able to address any corrective actions needed on site to mitigate potential stormwater contamination. All team members should:

- Consist of those people who are familiar with the facility and its operations;
- Possess the knowledge and skills to assess conditions and activities that could impact stormwater quality at your facility, and who can evaluate the effectiveness of control measures;
- Be located on-site on a daily basis;
- Have the primary responsibility for developing and overseeing facility activities necessary to comply with stormwater requirements;
- Have access to all applicable permit, monitoring, Stormwater Pollution Prevention Plan, and other records;
- Be trained in the operation, maintenance and inspections of all BMPs and reporting procedures;
- Establish responsibilities for inspections, operation, maintenance, and emergencies; and
- Regularly meet to review overall facility operations and BMP effectiveness.

## **S102E: BMPs for Preventive Maintenance/Good Housekeeping**

Preventive maintenance and good housekeeping practices reduce the potential for stormwater to come into contact with pollutants and can reduce maintenance intervals for the drainage system and sewer system.

### ***Applicable BMPs***

- Prevent the discharge of unpermitted liquid or solid wastes, process wastewater, and sewage to ground water or surface water, or to storm drains that discharge to surface water or to the ground. Conduct all oily parts cleaning, steam cleaning, or pressure washing of equipment or containers inside a building, or on an impervious contained area, such as a concrete pad. Direct contaminated stormwater from such an area to a sanitary sewer where allowed by local sewer authority, or to other approved treatment.
- Promptly contain and clean up solid and liquid pollutant leaks and spills, including oils, solvents, fuels, and dust from manufacturing operations on any exposed soil, vegetation, or paved area.
- If a contaminated surface must be pressure washed, collect the resulting washwater for proper disposal (usually involves plugging storm drains or otherwise preventing discharge, and pumping or vacuuming up washwater for discharge to sanitary sewer or for Vactor truck transport to a wastewater treatment plant for disposal).
- Do not hose down pollutants from any area to the ground, storm drains, conveyance ditches, or receiving water. Discharges/conveyances associated with dust control to meet air quality regulations shall be conveyed to a treatment system approved by the local jurisdiction prior to discharge.
- Sweep all appropriate surfaces (e.g., paved material handling and storage areas) with

vacuum sweepers quarterly or more frequently as needed for the collection and disposal of dust and debris that could contaminate stormwater.

- Do not pave over contaminated soil unless it has been determined that ground water has not been and will not be contaminated by the soil. Call the Washington State Department of Ecology (Ecology) for assistance.
- Construct impervious areas that are compatible with the materials handled. Portland cement concrete, asphalt, or equivalent material may be considered.
- Use drip pans to collect leaks and spills from industrial/commercial equipment such as cranes at ship/boat building and repair facilities, log stackers, industrial parts, and trucks and other vehicles stored outside.
- At industrial and commercial facilities, drain oil and fuel filters before disposal. Discard empty oil and fuel filters, oily rags, and other oily solid waste into appropriately closed and properly labeled containers, and in compliance with the Uniform Fire Code or International Building Code.
- For the storage of liquids use containers, such as steel and plastic drums, that are rigid and durable, corrosion resistant to the weather and fluid content, nonabsorbent, water tight, rodent-proof, and equipped with a close fitting cover.
- For the temporary storage of solid wastes contaminated with liquids or other potential polluted materials use dumpsters, garbage cans, drums and comparable containers, which are durable, corrosion resistant, nonabsorbent, nonleaking, and equipped with either a solid cover or screen cover to prevent littering. If covered with a screen, the container must be stored under a roof or other form of adequate.
- Where exposed to stormwater, use containers, piping, tubing, pumps, fittings, and valves that are appropriate for their intended use and for the contained liquid.
- Clean oils, debris, sludge, etc., from all stormwater BMPs regularly, including catch basins, settling/detention basins, oil and water separators, boomed areas, and conveyance systems, to prevent the contamination of stormwater. See Ecology Requirements for Generators of Dangerous Wastes at the following web address to assist in determining if a waste must be handled as hazardous waste:  
  
<https://ecology.wa.gov/Regulations-Permits/Guidance-technical-assistance/Dangerous-waste-guidance>
- Promptly repair or replace all substantially cracked or otherwise damaged paved secondary containment, high-intensity parking, and any other contributing areas, subjected to pollutant material leaks or spills. Promptly repair or replace all leaking connections, pipes, hoses, valves, etc., that can contaminate stormwater.
- Do not connect floor drains in potential pollutant source areas to storm drains, receiving water, or the ground.

## **Recommended BMPs**

- Where feasible, store potential stormwater pollutant materials inside a building or under a cover and/or containment.
- Minimize use of toxic cleaning solvents, such as chlorinated solvents, and other toxic chemicals.
- Use environmentally safe raw materials, products, additives, etc., such as substitutes for zinc used in rubber production.
- Recycle waste materials such as solvents, coolants, oils, degreasers, and batteries to the maximum extent feasible. Contact Ecology's Hazardous Waste and Toxics Reduction Program at the following web address, or your local jurisdiction, for recommendations on recycling or disposal of vehicle waste liquids and other waste materials:

<https://ecology.wa.gov/About-us/Get-to-know-us/Our-Programs/Hazardous-Waste-Toxics-Reduction>

- Empty drip pans immediately after a spill or leak is collected in an uncovered area.
- Stencil warning signs at catch basins and drains, e.g., "Dump no waste – Drains to water body."

**For more information:** See [S442E: BMPs for Labeling Storm Drain Inlets on Your Property](#).

- Use solid absorbents, e.g., clay and peat absorbents and rags for cleanup of liquid spills/leaks, where practicable.
- Promptly repair/replace/reseal damaged paved areas at industrial facilities.
- Recycle materials, such as oils, solvents, and wood waste, to the maximum extent practicable.

**Note:** Evidence of stormwater contamination can include the presence of visible sheen, color, or turbidity in the runoff; or present or historical operational problems at the facility. Operators can use simple pH tests, for example with litmus or pH paper. These tests can screen for high or low pH levels (anything outside the 6.5 to 8.5 range) due to contamination of stormwater.

## **S104E: BMPs for Spill Prevention and Cleanup**

### **Description of Pollutant Sources**

Spills and leaks can damage public infrastructure, interfere with sewage treatment, and cause a threat to human health or the environment. Spills are often preventable if appropriate chemical and waste handling techniques are practiced effectively and the spill response plan is immediately implemented. Additional spill control requirements may be required based on the specific activity occurring on site.

### **Applicable BMPs**

#### **Spill Prevention**

- Clearly label all containers that contain potential pollutants.
- Store and transport liquid materials in appropriate containers with tight-fitting lids.
- Place drip pans underneath all containers, fittings, valves, and where materials are likely to spill or leak.
- Use tarpaulins, ground clothes, or drip pans in areas where materials are mixed, carried, and applied to capture any spilled materials.
- Train employees on the safe techniques for handling materials used on the site and to check for leaks and spills.

### **Spill Plan**

- Develop and implement a spill plan and update it annually or whenever there is a change in activities or staff responsible for spill cleanup. Post a written summary of the plan at areas with a high potential for spills, such as loading docks, product storage areas, waste storage areas, and near a phone. The spill plan may need to be posted at multiple locations. Describe the facility, including the owner's name, address, and telephone number; the nature of the facility activity; and the general types of chemicals used at the facility.
- Designate spill response employees to be on-site during business activities. Provide a current list of the names and telephone numbers (home and office) of designated spill response employees who are responsible for implementing the spill plan.
- Provide a site plan showing the locations of storage areas for chemicals, inlets/catch basins, spill kits and other relevant infrastructure or materials information.
- Describe the emergency cleanup and disposal procedures. Note the location of all spill kits in the spill plan.
- List the names and telephone numbers of public agencies to contact in the event of a spill.

### **Spill Cleanup Kits**

- Store all cleanup kits near areas with a high potential for spills so that they are easily accessible in the event of a spill. The contents of the spill kit must be appropriate to the types and qualities of materials stored or otherwise used at the facility, and refilled when the materials are used. Facilities covered under the Industrial Stormwater General Permit must provide secondary containment for all chemical liquids, fluids, and petroleum products stored on-site. Spill kits must be located within 25 feet of all fueling/fuel transfer areas, including on-board mobile fuel trucks.
- Ecology recommends that the kit(s) be stored in an impervious container and include the following:
  - Salvage drums or containers, such as high-density polyethylene polypropylene, or polyethylene sheet-lined steel
  - Polyethylene or equivalent disposal bags

- An emergency response guidebook
- Safety gloves/clothes/equipment
- Shovels or other soil removal equipment
- Oil containment booms and absorbent pads

### **Spill Cleanup and Proper Disposal of Material**

- Stop, contain, and clean up all spills immediately upon discovery.
- Implement the spill plan immediately.
- Contact the designated spill response employees.
- Block off and seal nearby inlets/catch basins to prevent materials from entering the drainage system or combined sewer.
- Use the appropriate material to clean up the spill.
- Do not use emulsifiers or dispersants such as liquid detergents or degreasers.
- Immediately report all spills, discharges, or releases that could impact a drainage system, a combined sewer, a sanitary sewer, or a receiving water.
- Do not wash absorbent material into interior floor drains or inlets/catch basins.
- Place used spill control materials in appropriate containers and dispose of according to regulations.

### **S105E: BMPs for Employee Training**

Train all employees that work in pollutant source areas about the following topics:

- Identifying Pollution Prevention Team members
- Identifying pollutant sources
- Understanding pollutant control measures
- Spill prevention and response
- Emergency response procedures
- Handling practices that are environmentally acceptable. Particularly those related to vehicle/equipment liquids, such as fuels, and vehicle/equipment cleaning

Additional specialized training may be needed for staff who will be responsible for handling hazardous materials.

## **S106E: BMPs for Inspections**

Qualified personnel shall conduct visual inspections monthly. Make and maintain a record of each inspection on-site. The following requirements apply to inspections:

- Be conducted by someone familiar with the facility's site, operations, and BMPs.
- Verify of the accuracy of the pollutant source descriptions in the Stormwater Pollution Prevention Plan.
- Assess all BMPs that have been implemented for effectiveness and needed maintenance and locate areas where additional BMPs are needed.
- Reflect current conditions on the site.
- Include written observations of the presence of floating materials, suspended solids, oil and grease, discoloration, turbidity and odor in the stormwater discharges; in outside vehicle maintenance/repair; and liquid handling, and storage areas. In areas where acid or alkaline materials are handled or stored use a simple litmus or pH paper to identify those types of stormwater contaminants where needed.
- Eliminate or obtain a permit for unpermitted non-stormwater discharges to storm drains or receiving waters, such as process wastewater and vehicle/equipment washwater.

## **S107E: BMPs for Record Keeping**

See the applicable permit for specific record-keeping requirements and retention schedules for the following reports, at a minimum:

- Visual inspection reports which should include:
  - Time and date of the inspection,
  - Locations inspected,
  - Statement on status of compliance with the permit,
  - Summary report of any remediation activities required, and
  - Name, title, and signature of person conducting the inspection.
- Reports on spills of oil or hazardous substances in greater than the reportable quantities (40 [CFR 302.4](#) and 40 [CFR Part 117](#)). Report spills of antifreeze, oil, gasoline, or diesel fuel that cause:
  - A violation of the Washington State water quality standards,
  - A film or sheen upon or discoloration of the waters of the state or adjoining shorelines, or
  - A sludge or emulsion to be deposited beneath the surface of the water or upon adjoining shorelines.

To report a spill or to determine if a spill is a substance of a reportable quantity, call the Washington State Department of Ecology regional office and ask for an oil spill operations or a dangerous waste specialist:

- Eastern region 509-329-3400
- Central region 509-575-2490

In addition, call the Washington Emergency Management Division at 1-800-258-5990 or 1-800-OILS-911 and the National Response Center at 1-800-424-8802.

Also, see *Focus on Emergency Spill Response* ([Ecology, 2013](#)).

### ***Additional Recommended Record-Keeping Procedure***

Maintain records of all related pollutant control and pollution-generating activities, such as training, materials purchased, material use and disposal, maintenance performed, etc.

## **S108E: BMPs for Correcting Illicit Connections to Storm Drains**

### ***Description of Pollutant Sources***

Illicit connections are unpermitted sanitary or process wastewater discharges to a storm drain or to surface water, rather than to a sanitary sewer, industrial process wastewater, or other appropriate treatment. They can also include swimming pool water, filter backwash, cleaning solution-s/washwaters, cooling water, etc. Experience has shown that illicit connections are common, particularly in older buildings.

### ***Pollutant Control Approach***

Identify and eliminate unpermitted discharges or obtain a National Pollutant Discharge Elimination System Stormwater General Permit, where necessary, particularly at industrial and commercial facilities.

### ***Applicable Operational BMPs***

- Eliminate unpermitted wastewater discharges to storm drains, ground water, or surface water.
- Convey unpermitted discharges to a sanitary sewer if allowed by the local sewer authority, or to other approved treatment.
- Obtain appropriate state and local permits for these discharges.

### ***Recommended Operational BMPs***

At commercial and industrial facilities, conduct a survey of wastewater discharge connections to storm drains and to surface water as follows:

- Conduct a field survey of buildings, particularly older buildings, and other industrial areas to locate storm drains from buildings and paved surfaces. Note where these join the public storm drain(s).
- During non-stormwater conditions inspect each storm drain for non-stormwater discharges.



Record the locations of all non-stormwater discharges. Include all permitted discharges.

- If useful, prepare a map of each area. Show on the map the known location of storm drains, sanitary sewers, and permitted and unpermitted discharges. Aerial photos may be useful. Check records such as piping schematics to identify known side sewer connections and show these on the map. Consider using smoke, dye, or chemical analysis tests to detect connections between two conveyance systems (e.g., process water and stormwater). If desirable, conduct Closed Circuit Television (CCTV) inspections of the storm drains and record the footage.
- Compare the observed locations of connections with the information on the map and revise the map accordingly. Note suspect connections that are inconsistent with the field survey.
- Identify all connections to storm drains or to surface water and take the actions specified above as applicable BMPs.

*This page has been intentionally left blank for double-sided printing.*

## 8.2.3 Pollutant Source-Specific BMPs

### Introduction

Where required by local code or by a Washington State Department of Ecology (Ecology) National Pollutant Discharge Elimination System Stormwater General Permit (e.g., the Industrial Stormwater General Permit [ISGP]), implement the applicable source control BMPs at:

- Commercial properties,
- Industrial properties,
- Multifamily properties,
- Boatyards, and
- Sand and gravel mining operations.

The ISGP requires covered facilities to consider the recommended source control BMPs for Level 1 and 2 corrective actions.

Industrial sites covered by individual industrial stormwater permits must comply with the specific source control and runoff treatment BMPs listed in their permits. Operators under individual industrial stormwater permits may include additional BMPs from this manual, if desired.

The source-specific BMPs described in this section may be applied to control the sources of pollutants identified in [Appendix 8-A: Urban Land Uses and Pollution-Generating Sources](#). Ecology encourages all operators of facilities that implement pollution-generating sources in [Appendix 8-A: Urban Land Uses and Pollution-Generating Sources](#) to review their Stormwater Pollution Prevention Plans and use both the applicable and recommended BMPs where possible.

### ***BMPs in this Section***

[Table 8.1: Applicable Categories for Pollutant-Specific Source Control BMPs](#) groups various source control BMPs into seven applicable categories:

- Storage and stockpiling BMPs
- Cleaning or washing BMPs
- Transfer of liquid or solid materials BMPs
- Soil erosion, sediment control, and landscaping BMPs
- Roads, ditches, and parking lot BMPs
- Building maintenance BMPs
- Residential source control BMPs

**Table 8.1: Applicable Categories for Pollutant-Specific Source Control BMPs**

Source Control BMP	Storage and Stockpiling BMPs	Cleaning or Washing BMPs	Transfer of Liquid or Solid Material BMPs	Soil Erosion, Sediment Control, and Landscaping BMPs	Roads, Ditches, and Parking Lot BMPs	Building Maintenance BMPs	Residential BMPs
<a href="#">S401E: BMPs for the Building, Repair, and Maintenance of Boats and Ships</a>		✓	✓				
<a href="#">S402E: BMPs for Commercial Animal Handling Areas</a>	✓	✓					
<a href="#">S403E: BMPs for Commercial Composting</a>	✓		✓				
<a href="#">S404E: BMPs for Commercial Printing Operations</a>	✓		✓				
<a href="#">S405E: BMPs for Deicing and Anti-Icing Operations – Airports</a>	✓		✓		✓		
<a href="#">S406E: BMPs for Streets/Highways</a>	✓		✓		✓		
<a href="#">S407E: BMPs for Dust Control at Disturbed Land Areas and Unpaved Roadways and Parking Lots</a>				✓	✓		
<a href="#">S408E: BMPs for Dust Control at Manufacturing Areas</a>				✓	✓		
<a href="#">S409E: BMPs for Fueling at Dedicated Stations</a>			✓				
<a href="#">S411E: BMPs for Landscaping and Lawn/Vegetation Management</a>	✓		✓	✓			✓
<a href="#">S412E: BMPs for Loading and Unloading Areas for Liquid or Solid Material</a>			✓				
<a href="#">S413E: BMPs for Log Sorting and Handling</a>	✓		✓				
<a href="#">S414E: BMPs for Maintenance and Repair of Vehicles and Equipment</a>		✓	✓				
<a href="#">S415E: BMPs for Maintenance of Public and Private Utility Corridors and Facilities</a>				✓	✓		
<a href="#">S416E: BMPs for Maintenance of Roadside Ditches</a>			✓	✓	✓		
<a href="#">S417E: BMPs for Maintenance of Drainage Systems and Runoff Treatment BMPs</a>			✓		✓		
<a href="#">S418E: BMPs for Manufacturing Activities – Outside</a>	✓		✓		✓		

**Table 8.1: Applicable Categories for Pollutant-Specific Source Control BMPs (continued)**

Source Control BMP	Storage and Stockpiling BMPs	Cleaning or Washing BMPs	Transfer of Liquid or Solid Material BMPs	Soil Erosion, Sediment Control, and Landscaping BMPs	Roads, Ditches, and Parking Lot BMPs	Building Maintenance BMPs	Residential BMPs
<a href="#">S419E: BMPs for Mobile Fueling of Vehicles and Heavy Equipment</a>			✓				
<a href="#">S420E: BMPs for Painting/Finishing/Coating of Vehicles/Boats/Buildings/Equipment</a>	✓		✓				
<a href="#">S421E: BMPs for Parking and Storage of Vehicles and Equipment</a>					✓		
<a href="#">S422E: BMPs for Railroad Yards</a>	✓		✓				
<a href="#">S423E: BMPs for Recyclers and Scrap Yards</a>	✓		✓				
<a href="#">S424E: BMPs for Roof/Building Drains at Manufacturing and Commercial Buildings</a>						✓	
<a href="#">S425E: BMPs for Soil Erosion and Sediment Control at Industrial Sites</a>				✓			
<a href="#">S426E: BMPs for Spills of Oil and Hazardous Substances</a>			✓				
<a href="#">S427E: BMPs for Storage of Liquid, Food Waste, or Dangerous Waste Containers</a>	✓						
<a href="#">S428E: BMPs for Storage of Liquids in Permanent Aboveground Tanks</a>	✓						
<a href="#">S429E: BMPs for Storage or Transfer (Outside) of Solid Raw Materials, By-Products, or Finished Products</a>	✓		✓				
<a href="#">S430E: BMPs for Urban Streets</a>			✓		✓		
<a href="#">S431E: BMPs for Washing and Steam Cleaning Vehicles/Equipment/Building Structures</a>		✓					
<a href="#">S432E: BMPs for Wood Treatment Areas</a>	✓						
<a href="#">S433E: BMPs for Pools, Spas, Hot Tubs, and Fountains</a>		✓					
<a href="#">S434E: BMPs for Dock Washing</a>		✓					
<a href="#">S435E: BMPs for Pesticides and an Integrated Pest Management Program</a>				✓			

**Table 8.1: Applicable Categories for Pollutant-Specific Source Control BMPs (continued)**

Source Control BMP	Storage and Stockpiling BMPs	Cleaning or Washing BMPs	Transfer of Liquid or Solid Material BMPs	Soil Erosion, Sediment Control, and Landscaping BMPs	Roads, Ditches, and Parking Lot BMPs	Building Maintenance BMPs	Residential BMPs
<a href="#">S436E: BMPs for Color Events</a>	✓	✓	✓		✓		
<a href="#">S438E: BMPs for Construction Demolition</a>	✓		✓				
<a href="#">S439E: BMPs for In-Water and Over-Water Fueling</a>			✓				
<a href="#">S440E: BMPs for Pet Waste</a>							✓
<a href="#">S441E: BMPs for Potable Water Line Flushing, Water Tank Maintenance, and Hydrant Testing</a>		✓					
<a href="#">S442E: BMPs for Labeling Storm Drain Inlets on Your Property</a>			✓		✓		
<a href="#">S443E: BMPs for Fertilizer Application</a>				✓			
<a href="#">S444E: BMPs for the Storage of Dry Pesticides and Fertilizers</a>	✓		✓	✓			
<a href="#">S445E: BMPs for Temporary Fruit Storage</a>	✓		✓				
<a href="#">S446E: BMPs for Well, Utility, Directional, and Geotechnical Drilling</a>			✓	✓			
<a href="#">S447E: BMPs for Roof Vents</a>						✓	
<a href="#">S449E: BMPs for Nurseries and Greenhouses</a>	✓		✓	✓			
<a href="#">S450E: BMPs for Irrigation</a>				✓			
<a href="#">S451E: BMPs for Building, Repair, Remodeling, Painting, and Construction</a>	✓	✓	✓			✓	✓
<a href="#">S452E: BMPs for Goose Waste</a>							✓

## **S401E: BMPs for the Building, Repair, and Maintenance of Boats and Ships**

### ***Description of Pollutant Sources***

Sources of pollutants for the building, repair, and maintenance of boats and ships at boatyards, shipyards, ports, and marinas include pressure washing, surface preparation, paint removal, sanding, painting, engine maintenance and repairs, and material handling and storage, if conducted outdoors.

Potential pollutants include spent abrasive grits, solvents, oils, ethylene glycol, washwater, paint overspray, cleaners/detergents, anticorrosion compounds, paint chips, scrap metal, welding rods, resins, glass fibers, dust, and miscellaneous trash. Pollutant constituents include total suspended solids, oil and grease, organics, copper, lead, tin, and zinc.

### ***Pollutant Control Approach***

Apply good housekeeping, conduct routine preventive maintenance, and cover and contain Best Management Practices (BMPs) in and around work areas.

### ***NPDES Permit Requirements***

The Washington State Department of Ecology's (Ecology's) National Pollutant Discharge Elimination System (NPDES) Boatyard General Permit requires coverage of all boatyards in Washington State that engage in the construction, repair, and maintenance of small vessels, 85% of which are  $\leq 65$  feet in length, or revenues from which constitute  $> 85\%$  of gross receipts. Ecology may require coverage under an individual NPDES stormwater permit for large boatyards and shipyards in Washington State not covered by the Boatyard General Permit or the Industrial Stormwater General Permit (ISGP).

### ***Applicable Operational BMPs***

- Clean regularly all accessible work, service and storage areas to remove debris, spent sandblasting material, and any other potential stormwater pollutants.
- Whenever the boat is in the water, avoid the use of soaps, detergents, and other chemicals that need to be rinsed or hosed off. If necessary, consider applying sparingly so that a sponge, towel, or rag can be used to remove residuals. Instead consider washing the boat in a suitable controlled area (see [S431E: BMPs for Washing and Steam Cleaning Vehicles/Equipment/Building Structures](#)) while it is out of the water.
- Sweep rather than hose debris on the dock. Collect and convey hose water to treatment if hosing is unavoidable,
- Collect spent abrasives regularly and store them under cover to await proper disposal.
- Dispose of greasy rags, oil filters, air filters, batteries, spent coolant, and degreasers properly.
- Drain oil filters before disposal or recycling.
- Immediately repair or replace leaking connections, valves, pipes, hoses, and other equipment

that may cause the contamination of stormwater.

- Use drip pans, drop cloths, tarpaulins, or other protective devices in all paint mixing and solvent operations, unless carried out in impervious contained and covered areas.
- Convey sanitary sewage to pump-out stations, portable on-site pump-outs, commercial mobile pump-out facilities, or other appropriate onshore facilities.
- Maintain automatic bilge pumps in a manner that will prevent automatic pumping of waste material into surface water.
- Prohibit uncontained spray-painting, blasting, or sanding activities over open water.
- Do not dump or pour waste materials down floor drains, sinks, or outdoor storm drain inlets that discharge to surface water. Plug floor drains connected to storm drains or to surface water. If necessary, install a regularly operated sump pump.
- Prohibit outside spray-painting, blasting, or sanding activities during windy conditions that render containment ineffective.
- Do not burn paint and/or use spray guns on topsides or above decks.
- Immediately clean up any spillage on the pier, wharf, boat, ship deck, or adjacent surface areas and dispose of the wastes properly.
- Apply source control BMPs for other activities conducted at the marina, boat yard, shipyard, or port facility

**For more information:** [S409E: BMPs for Fueling at Dedicated Stations](#); [S431E: BMPs for Washing and Steam Cleaning Vehicles/Equipment/Building Structures](#); and [S426E: BMPs for Spills of Oil and Hazardous Substances](#)).

- Locate spill kits on all piers and docks.

### ***Applicable Structural Source Control BMPs***

- Use fixed platforms with appropriate plastic or tarpaulin barriers as work surfaces and for containment when performing work on a vessel in the water to prevent blast material or paint overspray from contacting stormwater or the receiving water. Keep the use of such platforms to a minimum and do not perform extensive repair, modification, surface preparation, or coating while the boat is in the water (anything in excess of 25% of the surface area of the vessel above the waterline).
- Use plastic or tarpaulin barriers beneath the hull and between the hull and dry dock walls to contain and collect waste and spent materials. Clean and sweep regularly to remove debris.
- Enclose, cover, or contain blasting and sanding activities to the maximum extent practicable to prevent abrasives, dust, and paint chips, from reaching storm drains or receiving waters. Use plywood and/or plastic sheeting to cover open areas between decks when sandblasting (scuppers, railings, freeing ports, ladders, and doorways).



- Direct deck drainage to a collection system sump for settling and/or additional treatment.
- Store cracked batteries in covered secondary containers.

### ***Recommended Operational BMPs***

- Consider recycling paint, paint thinner, solvents, used oils, oil filters, pressure wash wastewater, and any other recyclable materials.
- Perform paint and solvent mixing, fuel mixing, etc., on shore.

## **S402E: BMPs for Commercial Animal Handling Areas**

### ***Description of Pollutant Sources***

Animals at racetracks, kennels, fenced pens, veterinarians, and businesses that provide boarding services for horses, dogs, cats, etc., can generate pollutants from the following activities: manure deposits, animal washing, grazing, and any other animal handling activity that could contaminate stormwater. Pollutants can include coliform bacteria, nutrients, and total suspended solids. Individual stormwater permits covering commercial animal handling facilities include additional applicable source controls.

### ***Pollutant Control Approach***

To prevent, to the maximum extent practicable, the discharge of contaminated stormwater from animal handling and keeping areas.

### ***Applicable Operational BMPs***

- Regularly sweep and clean animal keeping areas to collect and properly dispose of droppings, uneaten food, and other potential stormwater contaminants.
- Do not hose down areas that contain potential stormwater contaminants where they drain into storm drains or to receiving waters.
- Do not discharge any washwater to storm drains or to receiving water without proper treatment.
- If the operator keeps animals in unpaved and uncovered areas, the ground must have either a vegetative cover or some other type of ground cover such as mulch.
- Surround the area where animals are kept with a fence or other means to prevent animals from moving away from the controlled area where BMPs are used.
- For outside surface areas that must be disinfected, use an unsaturated mop to spot clean the area. Do not allow wastewater runoff to enter the drainage system.
- Do not stockpile manure in areas where runoff is allowed to flow into a storm drain or to nearby receiving waters or wetlands.

## **S403E: BMPs for Commercial Composting**

### ***Description of Pollutant Sources***

Commercial composting facilities, operating outside without cover, require large areas to decompose wastes and other feedstocks. Design these facilities to separate stormwater from leachate (i.e., industrial wastewater) to the greatest extent possible. When stormwater contacts any active composting areas, including waste receiving and processing areas, it becomes leachate. Pollutants in leachate include nutrients, biochemical oxygen demand, organics, coliform bacteria, acidic pH, color, and suspended solids. Stormwater at composting facilities includes runoff from areas not associated with active processing and curing, such as product storage areas, vehicle maintenance areas, and access roads.

### ***NPDES and State Solid Waste Permit Requirements***

Composting facilities are regulated under [WAC 173-350-220](#). These regulations require the collection and containment of all leachate produced from activities at commercial composting facilities. Composting facilities that propose to discharge to surface water, municipal sewer system, or ground water must obtain the appropriate permits. Zero discharge is possible by containing all leachate from the facility (in tanks or ponds) for use early in the composting process or preventing production of leachate (by composting under a roof or in an enclosed building).

### ***Pollutant Control Approach***

Consider zero leachate discharge.

### ***Applicable Operational, Structural, and Treatment BMPs***

- See [WAC 173-350-220](#), Composting Facilities
- See Siting and Operating Composting Facilities in Washington State: Good Management Practices (Ecology, 2013b) for common sense actions that can be implemented at a facility to help run a successful program.
- See the Washington State Department of Ecology's (Ecology's) Organic Materials Management Law and Rule web page at the following address for the most up-to-date information:  
  
<https://ecology.wa.gov/Waste-Toxics/Reducing-recycling-waste/Organic-materials>
- All composting facilities shall obtain the appropriate state and local permits. Contact your local permitting authority and jurisdictional health department or district for more information.
- Apply for coverage under the Industrial Stormwater General Permit (ISGP) if the facility discharges stormwater to surface water or a municipal drainage system. If all stormwater from the facility properly infiltrates to ground water, the ISGP is not required. There are some cases where an Individual State Waste Discharge permit is required (see <https://ecology.wa.gov/Water-Shorelines/Water-quality/Water-quality-permits/Water-Quality-individual-permits>). Check with your local Ecology office and jurisdictional health department or district to discuss your permitting options.
- Screen incoming wastes for dangerous materials and solid wastes. These materials may not

be accepted for composting and must be properly disposed of.

- Locate composting areas on impervious surfaces.
- Drain all leachate from composting operations to a sanitary sewer, holding tank, or on-site treatment system. Leachate may not go to the storm drain or groundwater.
- Collect the leachate with a dike or berm, or with intercepting drains placed on the down slope side of the compost area.
- Direct outside runoff away from the composting areas.
- Clean up debris from yard areas as needed to prevent stormwater contamination.

### ***Recommended BMPs***

- Install catch basin inserts to collect excess sediment and debris if necessary. Inspect and maintain catch basin inserts to ensure they are working correctly.
- Locate stored residues in areas designed to collect leachate and limit storage times of residues to prevent degradation and generation of leachate.

## **S404E: BMPs for Commercial Printing Operations**

### ***Description of Pollutant Sources***

Materials used in the printing process include inorganic and organic acids, resins, solvents, polyester film, developers, alcohol, vinyl lacquer, dyes, acetates, and polymers. Waste products may include waste inks and ink sludge, resins, photographic chemicals, solvents, acid and alkaline solutions, chlorides, chromium, zinc, lead, spent formaldehyde, silver, plasticizers, and used lubricating oils. With indoor printing operations, the only likely points of potential contact with stormwater are the outside temporary storage of waste materials and offloading of chemicals at external unloading bays. Pollutants can include total suspended solids, pH, heavy metals, oil and grease, and chemical oxygen demand.

### ***Pollutant Control Approach***

Ensure appropriate disposal and National Pollutant Discharge Elimination System Stormwater General Permit coverage of process wastes. Cover and contain stored raw and waste materials.

### ***Applicable Operational BMPs***

- Discharge process wastewaters to a sanitary sewer, if approved by the local sewer authority, or to an approved process wastewater treatment system.
- Do not discharge process wastes or wastewaters into storm drains or receiving water.
- Determine whether any of these wastes qualify for regulation as dangerous wastes and dispose of them accordingly.
- Store raw materials or waste materials that could contaminate stormwater in covered and contained areas.

- Train all employees in pollution prevention, spill response, and environmentally acceptable materials handling procedures.
- Store materials in proper, appropriately labeled containers. Identify and label all chemical substances.
- Regularly inspect all stormwater management devices and maintain as necessary.
- Try to use press washes without listed solvents, and with the lowest content of volatile organic compounds possible. Do not evaporate ink cleanup trays to the outside atmosphere.
- Place cleanup sludges into a container with a tight lid and dispose of it as dangerous waste. Do not dispose of cleanup sludges in the garbage or in containers of soiled towels.

**For more information:** For additional information on pollution prevention, the Washington State Department of Ecology recommends the following publication: *A Guide for Lithographic Printers* (Ecology, 2001).

## **S405E: BMPs for Deicing and Anti-Icing Operations – Airports**

See [40 CFR Part 449](#) for U.S. Environmental Protection Agency (U.S. EPA) effluent limitation guidelines and new source performance standards to control discharges of pollutants from airport deicing operations.

### ***Description of Pollutant Sources***

Operators use deicing and/or anti-icing compounds on airport runways, taxiways, and on aircraft to control ice and snow. Typically, ethylene glycol and propylene glycol are the deicing chemicals used on aircraft. Deicing chemicals commonly used on runways, taxiways, and other hard surfaces include calcium magnesium acetate (CMA), calcium chloride, magnesium chloride, sodium chloride, urea, and potassium acetate. The deicing and anti-icing compounds become pollutants when conveyed to storm drains or to receiving water after application. Leaks and spills of these chemicals can also occur during their handling and storage.

### ***Pollutant Control Approach for Aircraft***

Spent glycol discharges in aircraft application areas are regulated process wastewaters under the Washington State Department of Ecology's Industrial Stormwater General Permit. BMPs for aircraft deicing/anti-icing chemicals must be consistent with aviation safety and the operational needs of the aircraft operator.

### ***Applicable BMPs for Aircraft***

- Conduct aircraft deicing or anti-icing applications in impervious containment areas. Collect spent aircraft deicing or anti-icing chemicals, such as glycol, draining from aircraft in deicing or anti-icing application areas and convey them to a sanitary sewer, treatment, or other approved disposal or recovery method. Divert deicing runoff from paved gate areas to appropriate collection areas or conveyances for proper treatment or disposal.
- Do not discharge spent deicing or anti-icing chemicals or stormwater contaminated with aircraft deicing or anti-icing chemicals from application areas, including gate areas, into storm

drains. No discharge to receiving water, or ground water, directly or indirectly should occur.

- Transfer deicing and anti-icing chemicals on an impervious containment pad, or equivalent spill/leak containment area, and store in secondary containment areas. See [S428E: BMPs for Storage of Liquids in Permanent Aboveground Tanks](#).

**Note:** Applicable containment BMPs for aircraft deicing/anti-icing applications, and applicable runoff treatment BMPs for spent deicing/anti-icing chemicals such as glycols, apply.

### ***Recommended BMPs for Aircraft***

- Establish a centralized aircraft deicing/anti-icing facility, if practicable, or in designated areas of the tarmac equipped with separate collection drains for the spent deicing liquids.
- Consider installing an aircraft deicing/anti-icing chemical recovery system, or contract with a chemical recycler.

### ***Applicable BMPs for Airport Runways/Taxiways***

- Avoid excessive application of all deicing/anti-icing chemicals, which could contaminate stormwater.
- Store and transfer deicing/anti-icing materials on an impervious containment pad or an equivalent containment area and/or under cover in accordance with [S429E: BMPs for Storage or Transfer \(Outside\) of Solid Raw Materials, By-Products, or Finished Products](#). Consider other material storage and transfer approaches only if the deicing/anti-icing material will not contaminate stormwater.

### ***Recommended BMPs for Airport Runways/Taxiways***

- Include limits on toxic materials and phosphorus in the specifications for deicing/anti-icing chemicals, where applicable.
- Consider using anti-icing materials rather than deicing chemicals if their use will result in less adverse environmental impact.
- Select cost-effective deicing/anti-icing chemicals that cause the least adverse environmental impact.

## **S406E: BMPs for Streets/Highways**

### ***Description of Pollutant Sources***

These BMPs apply to the maintenance and deicing/anti-icing of streets and highways. Deicing products can be conveyed during storm events to inlets/catch basins or to receiving waters after application. Leaks and spills of these products can also occur during their handling and storage. Equipment and processes used during maintenance can contribute pollutants such as oil and grease, suspended solids, turbidity, high pH, and metals.

### ***Pollutant Control Approach***

Apply good housekeeping practices, preventive maintenance, properly train employees, and use materials that cause less adverse effects on the environment.

## **Applicable BMPs**

### **Deicing and Anti-Icing Operations**

- Select deicing and anti-icing chemicals that cause the least adverse environmental impact. Apply only as needed using minimum quantities.
- Where feasible and practicable, use roadway deicing chemicals that cause the least adverse environmental impact.
- Adhere to manufacturer's guidelines and industry standards of use and application.
- Store and transfer deicing/anti-icing materials on an impervious containment pad in accordance with [S429E: BMPs for Storage or Transfer \(Outside\) of Solid Raw Materials, By-Products, or Finished Products](#).
- Sweep/clean up accumulated deicing/anti-icing materials and grit from roads as soon as practicable after the road surface clears.
- Minimize use in areas where runoff or spray from the roadway immediately enters sensitive areas such as fish-bearing streams.

### **Maintenance Operations**

- Use drip pans or absorbents wherever concrete, asphalt, asphalt emulsion, paint product, and drips are likely to spill, such as beneath discharge points from equipment.
- Cover and contain nearby storm drains to keep runoff from entering the storm drainage system.
- Collect and contain all solids, slurry, and rinse water. Do not allow these to enter gutters, storm drains, or drainage ditches or onto the paved surface of a roadway or driveway.
- Designate an area onsite for washing hand tools and collect that water for disposal.
- Conduct all fueling of equipment in accordance with [S419E: BMPs for Mobile Fueling of Vehicles and Heavy Equipment](#).
- Do not use diesel fuel for cleaning or prepping asphalt tools and equipment.
- Sweep areas as frequently as needed. Collect all loose aggregate and dust for disposal. Do not hose down areas into storm drains.
- Store all fuel, paint, and other products on secondary containment.
- Conduct paint striping operations during dry weather.

## **Recommended BMPs**

- Intensify roadway cleaning in early spring to help remove particulates from road surfaces.
- Include limits on toxic metals in the specifications for deicing/anti-icing chemicals.
- Research admixtures (e.g., corrosion inhibitors and surfactants) to determine what additional

pollutants may be an issue. Verify with the local jurisdiction if there are any restrictions on admixtures.

- Install catch basin inserts to collect excess sediment and debris as necessary. Inspect and maintain catch basin inserts to ensure they are working correctly.

## **S407E: BMPs for Dust Control at Disturbed Land Areas and Unpaved Roadways and Parking Lots**

**Note:** Contact the local air quality authority for appropriate and required BMPs for dust control to implement at your project site. See the following web address for more information:

**Note:** <https://ecology.wa.gov/About-us/Our-role-in-the-community/Partnerships-committees/Clean-air-agencies>

### ***Description of Pollutant Sources***

Dust can cause air and water pollution problems, particularly at demolition sites and in arid areas where reduced rainfall exposes soil particles to transport by air.

### ***Pollutant Control Approach***

Minimize dust generation and apply environmentally friendly and government-approved dust suppressant chemicals, if necessary.

### ***Applicable Operational BMPs***

- Sprinkle or wet down soil or dust with water as long as it does not result in a wastewater discharge.
- Use only dust suppressant chemicals that are approved by the local jurisdiction and/or state government, such as those listed in *Methods for Dust Control* ([Ecology, 2016c](#)).
- Avoid excessive and repeated applications of dust suppressant chemicals. Time the application of dust suppressants to avoid or minimize their wash-off by rainfall or human activity, such as irrigation.
- Apply stormwater containment to prevent the conveyance of sediment into storm drains or receiving waters.
- Protect inlets/catch basins during application of dust suppressants.
- Ecology prohibits the use of motor oil for dust control. Take care when using lignin derivatives and other chemicals with a high biochemical oxygen demand in areas susceptible to contamination of surface water or ground water.
- Consult with the Washington State Department of Ecology and the local permitting authority on discharge permit requirements if the dust suppression process results in a wastewater discharge to the ground, ground water, storm drain, or surface water.
- Street gutters, sidewalks, driveways, and other paved surfaces in the immediate area of the activity must be swept regularly to collect and properly dispose of loose debris and garbage.

- Install catch basin filter socks on site and in surrounding catch basins to collect sediment and debris. Maintain the filters regularly to prevent plugging.

### ***Recommended Operational BMPs for Roadways and Other Trafficked Areas***

- Consider limiting use of off-road recreational vehicles on dust-generating land.
- Consider graveling or paving unpaved permanent roads and other trafficked areas at municipal, commercial, and industrial areas.
- Consider paving or stabilizing shoulders of paved roads with gravel, vegetation, or chemicals approved by the local jurisdiction.
- Encourage use of alternate paved routes, if available.
- Vacuum sweep fine dirt and skid control materials from paved roads soon after winter weather ends or when needed.
- Consider using prewashed traction sand to reduce dust emissions.

### ***Recommended Operational BMPs for Dust-Generating Areas***

- Prepare a dust control plan. Helpful references include *Control of Open Fugitive Dust Sources* ([Cowherd et al., 1988](#)) and *Fugitive Dust Background Document and Technical Information Document for Best Available Control Measures* ([U.S. EPA, 1992](#)).
- Limit exposure of soil (dust source) as much as feasible.
- Stabilize dust-generating soil by growing and maintaining vegetation, mulching, topsoiling, and/or applying rock, sand, or gravel.
- Apply windbreaks in the soil, such as trees, board fences, tarpaulin curtains, bales of hay, etc.

## **S408E: BMPs for Dust Control at Manufacturing Areas**

**For more information:** Contact the local air quality authority for appropriate and required BMPs for dust control to implement at your project site. See the following web address for more information:

**Note:** <https://ecology.wa.gov/About-us/Our-role-in-the-community/Partnerships-committees/Clean-air-agencies>

### ***Description of Pollutant Sources***

Industrial material handling activities can generate considerable amounts of dust that is typically removed using exhaust systems. Mixing cement and concrete products and handling powdered materials can also generate dust. Particulate materials that can cause air pollution include grain dust, sawdust, coal, gravel, crushed rock, cement, and boiler fly ash. Air emissions can contaminate stormwater. The objective of this BMP is to reduce the stormwater pollutants caused by dust generation and control.



## ***Pollutant Control Approach***

Prevent dust generation and emissions where feasible, regularly clean up dust that can contaminate stormwater, and convey dust-contaminated stormwater to proper treatment.

### ***Applicable BMPs***

- Clean, as needed, powder-material-handling equipment and vehicles.
- Regularly sweep dust accumulation areas that can contaminate stormwater. Conduct sweeping using vacuum filter equipment to minimize dust generation and to ensure optimal dust removal.
- Use dust filtration/collection systems such as baghouse filters, cyclone separators, etc. to control vented dust emissions that could contaminate stormwater. Control of zinc dusts in rubber production is one example.
- Maintain on-site controls to prevent vehicle track-out.
- Maintain dust collection devices on a regular basis.

### ***Recommended BMPs***

- In manufacturing operations, train employees to handle powders carefully to prevent generation of dust.
- Use dust filtration/collection systems such as bag house filters, cyclone separators, etc., to control vented dust emissions that could contaminate stormwater. Control of zinc dusts in rubber production is one example.
- Use water spray to flush dust accumulations to sanitary sewers where allowed by the local sewer authority or to other appropriate treatment system.
- Use approved dust suppressants such as those listed in *Methods for Dust Control* ([Ecology, 2016c](#)). Application of some products may not be appropriate in proximity to receiving waters or conveyances close to receiving waters. For more information, check with the Washington State Department of Ecology or the local jurisdiction.

### ***Recommended Runoff Treatment BMPs***

Install sedimentation basins, wetponds, wetvaults, catch basin filters, vegetated filter strips, or equivalent sediment removal BMPs.

## **S409E: BMPs for Fueling at Dedicated Stations**

### ***Description of Pollutant Sources***

A fueling station is a facility dedicated to the transfer of fuels from a stationary pumping station to mobile vehicles or equipment. It includes aboveground or underground fuel storage facilities. Fueling may occur at the following:

- General service gas stations
- 24-hour convenience stores

- Construction sites
- Maintenance yards
- Warehouses
- Car washes
- Manufacturing establishments
- Port facilities
- Marinas
- Boatyards
- Businesses with fleet vehicles.

Typical causes of stormwater contamination at fueling stations include leaks/spills of fuels, lubrication oils, radiator coolants, and vehicle washwater.

### ***Pollutant Control Approach***

New or substantially remodeled fueling stations must be constructed on an impervious concrete pad under a roof to keep out rainfall and stormwater run-on. The facility must use a runoff treatment BMP for contaminated stormwater and wastewaters in the fueling containment area.

*Substantial remodeling* refers to replacing the canopy or relocating or adding one or more fuel dispensers in a way that modifies the Portland cement concrete (or equivalent) paving in the fueling area.

### ***Applicable Operational BMPs***

For new or substantially remodeled fueling stations:

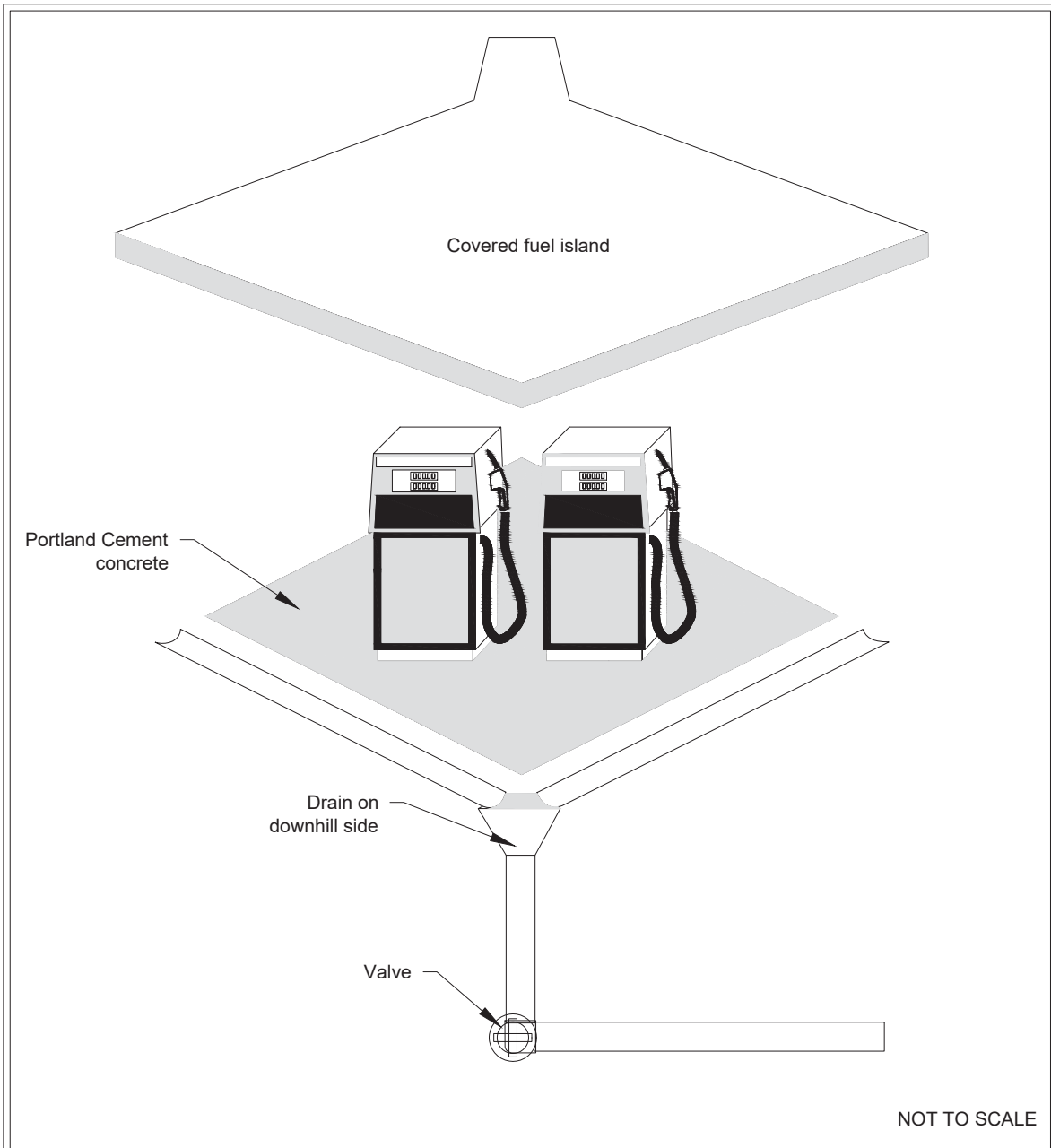
- Prepare a spill prevention control and countermeasures (SPCC) plan (per [S426E: BMPs for Spills of Oil and Hazardous Substances](#)).
- Train employees on the proper use of fuel dispensers and on the spill plan.
- Have designated trained person(s) available either on-site or on call at all times to promptly and properly implement the spill plan and immediately cleanup all spills.
- If the fueling station is unattended by a trained person during operating hours, the spill plan must be visible to all customers and untrained employees using the station, and the spill kit must also be accessible and fully stocked at all times.
- The person conducting the fuel transfer must be present at the fueling pump during fuel transfer, particularly at unattended or self-serve stations.
- Keep suitable cleanup materials, such as dry adsorbent materials, on-site to allow prompt cleanup of a spill.
- Do not use dispersants to clean up spills or sheens.

- Post signs in accordance with the Uniform Fire Code (UFC) or International Fire Code (IFC). For example, post “No Topping Off” signs (topping off gas tanks causes spillage and vents gas fumes to the air).
- Make sure that the automatic shut-off on the fuel nozzle is functioning properly.
- See [S439E: BMPs for In-Water and Over-Water Fueling](#).

### **Applicable Structural Source Control BMPs**

- Design the fueling island to:
  - Minimize stormwater contamination,
  - Control spills (dead-end sump or spill control separator in compliance with the UFC or IFC), and
  - Collect stormwater and/or wastewater and direct it to an appropriate treatment system.
- Slope the concrete containment pad around the fueling island toward drains; either trench drains, catch basins and/or a dead-end sump. The slope of the drains shall not be < 1% (Section 7901.8 of the UFC or Section 5703.6.8 of the IFC).
- Drains to runoff treatment BMPs must have a normally closed shutoff valve, which must be closed in the event of a spill. The spill control sump must be sized in compliance with Section 7901.8 of the UFC or Section 5703.6.8 of the IFC.
- Design the fueling island as a spill containment pad with a sill or berm raised to a minimum of 4 inches (Section 7901.8 of the UFC or Section 5703.6.8 of the IFC) to prevent the runoff of spilled liquids and to prevent run-on of stormwater from the surrounding area. Raised sills are not required at the open-grate trenches that connect to an approved drainage-control system.
- The fueling pad must be paved with Portland cement concrete, or equivalent. Ecology does not consider asphalt an equivalent material.
- The fueling island must have a roof or canopy to prevent the direct entry of precipitation onto the spill containment pad (see [Figure 8.1: Covered Fuel Island](#)). The roof or canopy should, at a minimum, cover the spill containment pad (within the grade break or fuel dispensing area) and preferably extend 3 feet on each side for roofs and canopies ≤ 10 feet in height and 5 feet on each side for roofs and canopies > 10 feet in height. Overhangs reduce the introduction of windblown rain. Measure the overhang relative to the berm or other hydraulic grade break for the spill containment pad.

**Figure 8.1: Covered Fuel Island**



## Covered Fuel Island

Revised June 2016

Please see <http://www.ecy.wa.gov/copyright.html> for copyright notice including permissions, limitation of liability, and disclaimer.

- Convey all roof drains to storm drains outside the fueling containment area.
- Convey stormwater collected on the fuel island containment pad to a sanitary sewer system, if approved by the sanitary authority, or to an approved runoff treatment BMP such as an oil and water separator and a basic treatment BMP. (Basic treatment BMPs are listed in Chapter 5.) Discharges from runoff treatment BMPs to storm drains or surface water or to the ground must not display ongoing or recurring visible sheen and must not contain oil and grease (O&G).
- Alternatively, collect stormwater from the fuel island containment pad and hold for proper off-site disposal.
- Approval from the local sewer authority is required for conveyance of any fuel-contaminated stormwater to a sanitary sewer. The discharged stormwater must comply with pretreatment regulations ([WAC 173-216-060](#)). These regulations prohibit discharges that could “cause fire or explosion.” State and federal pretreatment regulations define an explosive or flammable mixture based on a flash point determination of the mixture. Stormwater could be conveyed to a sanitary sewer system if it is determined not to be explosive.
- Transfer the fuel from the delivery tank trucks to the fuel storage tank in impervious contained areas and ensure that appropriate overflow protection is used. Alternatively, cover nearby storm drains during the filling process and use drip pans under all hose connections.

### ***Additional BMP for Vehicles 10 Feet in Height or Greater***

A roof or canopy may not be feasible at fueling stations that regularly fuel vehicles that are  $\geq 10$  feet in height, particularly at industrial or Washington State Department of Transportation sites. At those types of fueling facilities, the following BMPs apply, as well as the applicable BMPs and fire prevention (UFC or IFC requirements) of this BMP for fueling stations:

- If a roof or canopy is impractical the concrete fueling pad must be equipped with emergency spill control including a shutoff valve for the drainage from the fueling area. Maintain the valve in closed position in the event of a spill. An electronically actuated (automatic) valve is preferred to minimize the time lapse between spill and containment. Clean up spills and dispose of materials off-site in accordance with [S426E: BMPs for Spills of Oil and Hazardous Substances](#).
- The valve may be opened to convey contaminated stormwater to a sanitary sewer, if approved by the sewer authority, or to oil removal treatment such as an American Petroleum Institute or coalescing plate oil and water separator, catch basin insert, or equivalent treatment, and then to a basic treatment BMP. Discharges from treatment systems to storm drains or surface water or to the ground must not display ongoing or recurring visible sheen and must not contain greater than a significant amount of O&G.

## **S411E: BMPs for Landscaping and Lawn/Vegetation Management**

### ***Description of Pollutant Sources***

Landscaping can include grading, soil transfer, vegetation planting, and vegetation removal. Examples include weed control on golf course lawns, access roads, and utility corridors and during landscaping; and residential lawn/plant care. Proper management of vegetation can minimize excess nutrients and pesticides.

### ***Pollutant Control Approach***

Maintain appropriate vegetation to control erosion and the discharge of stormwater pollutants. Prevent debris contamination of stormwater. Where practicable, grow plant species appropriate for the site, or adjust the soil properties of the site to grow desired plant species.

### ***Applicable Operational BMPs***

- Amend soils to improve the infiltration and regulation of stormwater in landscaped areas.
- Select the right plants for the planting location based on soil conditions, sun exposure, water availability, height, sight factors, and space available.
- Ensure that plants selected for planting are not on the Washington State Noxious Weed Control Board's noxious weed list. See <https://www.nwcb.wa.gov/>

For example, butterfly bush often gets planted as an ornamental but is on the noxious weed list.

- Do not dispose of collected vegetation into receiving waters or drainage systems.
- Do not blow vegetation or other debris into the drainage system.
- Dispose of collected vegetation such as grass clippings, leaves, sticks by composting or recycling.
- Remove, bag, and dispose of class A and B noxious weeds in the garbage immediately.
- Do not compost noxious weeds as it may lead to spreading through seed or fragment if the composting process is not hot enough.
- Use manual and/or mechanical methods of vegetation removal (pincer-type weeding tools, flame weeders, or hot water weeders as appropriate) rather than applying herbicides, where practical.
- Use  $\geq 8$ -inches of topsoil with  $\geq 8\%$  organic matter to provide a sufficient vegetation-growing medium.
  - Organic matter is the least water-soluble form of nutrients that can be added to the soil. Composted organic matter generally releases only between 2% and 10% of its total nitrogen each year, and this release corresponds closely to the plant growth cycle.

Return natural plant debris and mulch to the soil, to continue recycling nutrients indefinitely.

- Select the appropriate turfgrass mixture for the climate and soil type.
  - Certain tall fescues and rye grasses resist insect attack because the symbiotic endophytic fungi found naturally in their tissues repel or kill common leaf and stem-eating lawn insects.
    - The fungus causes no known adverse effects on the host plant or humans.
    - Tall fescues and rye grasses do not repel root-feeding lawn pests such as crane fly larvae.
    - Tall fescues and rye grasses are toxic to ruminants such as cattle and sheep.
  - Endophytic grasses are commercially available; use them in areas such as parks or golf courses where grazing does not occur.
  - Local agricultural or gardening resources such as Washington State University Extension offices can provide advice on which types of grass are best suited to the area and soil type.
- Use the following seeding and planting BMPs in [Chapter 7 - Construction Stormwater Pollution Prevention](#), or equivalent BMPs, to obtain information on grass mixtures, temporary and permanent seeding procedures, maintenance of a recently planted area, and fertilizer application rates:
  - [BMP C120E: Temporary and Permanent Seeding](#)
  - [BMP C121E: Mulching](#)
  - [BMP C123E: Plastic Covering](#)
  - [BMP C124E: Sodding](#)
- Adjusting the soil properties of the subject site can assist in selection of desired plant species. Consult a soil restoration specialist for site-specific conditions. Aerate lawns regularly in areas of heavy use where the soil tends to become compacted. Conduct aeration while the grasses in the lawn are growing most vigorously. Remove layers of thatch > 0.75 inches deep.
- Set the mowing height at the highest acceptable level and mow at times and intervals designed to minimize stress on the turf. Generally mowing only one-third of the grass blade height will prevent stressing the turf.
  - Mowing is a stress-creating activity for turfgrass.
  - The productivity of grass decreases when it is mowed too short and there is less growth of roots and rhizomes. The turf becomes less tolerant of environmental stresses, more disease prone, and more reliant on outside means such as pesticides, fertilizers, and irrigation to remain healthy.

## **Recommended Operational BMPs**

- Conduct mulch-mowing whenever practicable.
- Use native plants in landscaping. Native plants do not require extensive fertilizer or pesticide applications. Native plants may also require less watering.
- Use mulch or other erosion control measures on soils exposed for > 1 week during the dry season (July 1 to September 30) or 2 days during the wet season (October 1 to June 30).
- Till a topsoil mix or composted organic material into the soil to create a well-mixed transition layer that encourages deeper root systems and drought-resistant plants.
- Apply an annual topdressing of 3/8 inches of compost. Amending existing landscapes and turf systems by increasing the percentage of organic matter and depth of topsoil can:
  - Substantially improve the permeability of the soil,
  - Increase the disease and drought resistance of the vegetation, and
  - Reduce the demand for fertilizers and pesticides.
- Disinfect gardening tools after pruning diseased plants to prevent the spread of disease.
- Prune trees and shrubs in a manner appropriate for each species.
- If specific plants have a high mortality rate, assess the cause and replace with another more appropriate species.
- When working around and below mature trees, follow the most current American National Standards Institute (ANSI) A300 standards (see [http://www.tcia.org/TCIA/BUSINESS/ANSI\\_A300\\_Standards\\_/TCIA/BUSINESS/A300\\_Standards/A300\\_Standards.aspx?hkey=202ff566-4364-4686-b7c1-2a365af59669](http://www.tcia.org/TCIA/BUSINESS/ANSI_A300_Standards_/TCIA/BUSINESS/A300_Standards/A300_Standards.aspx?hkey=202ff566-4364-4686-b7c1-2a365af59669)) and International Society of Arboriculture (ISA) BMPs to the extent practicable (e.g., take care to minimize any damage to tree roots and avoid compaction of soil).
- Monitor tree support systems (stakes, guys, etc.) and take the following actions:
  - Repair and adjust as needed to provide support and prevent tree damage.
  - Remove tree supports after one growing season or maximum of 1 year.
  - Backfill stake holes after removal.
- When continued, regular pruning (more than one time during the growing season) is required to maintain visual sight lines for safety or clearance along a walk or drive, consider relocating the plant to a more appropriate location.
- Make reasonable attempts to remove and dispose of class C noxious weeds.
- Reseed bare turf areas until the vegetation fully covers the ground surface.
- Watch for and respond to new occurrences of especially aggressive weeds such as Himalayan blackberry, Japanese knotweed, morning glory, English ivy, and reed canarygrass



to avoid invasions.

- Plant and protect trees per [BMP F6.62: Trees](#).

### **Additional BMP Information**

- The ISA is a group that promotes the professional practice of arboriculture and fosters a greater worldwide awareness of the benefits of trees through research, technology, and education. ISA standards used for managing trees, shrubs, and other woody plants are the ANSI A300 standards. The ANSI A300 standards are voluntary industry consensus standards developed by the Tree Care Industry Association and written by the Accredited Standards Committee. The ANSI standards can be found on the ISA website at the following address:

<http://www.isa-arbor.com/education/publications/index.aspx>

- Washington State University's Gardening in Washington State web page contains Washington State-specific information about vegetation management based on the type of landscape:

<http://gardening.wsu.edu/>

- Washington State University County Extension offices, see the following website:

<http://extension.wsu.edu/locations/>

- See the *Pacific Northwest Plant Disease Management Handbook* ([Pscheidt and Ocamb, 2016](#)) for information on disease recognition and for additional resources.

## **S412E: BMPs for Loading and Unloading Areas for Liquid or Solid Material**

### ***Description of Pollutant Sources***

Operators typically conduct loading/unloading of liquid and solid materials at industrial and commercial facilities at shipping and receiving, outside storage, fueling areas, etc. Materials transferred can include products, raw materials, intermediate products, waste materials, fuels, scrap metals, etc. Leaks and spills of fuels, oils, powders, organics, heavy metals, salts, acids, alkalis, etc., during transfer may cause stormwater contamination. Spills from hydraulic line breaks are a common problem at loading docks.

### ***Pollutant Control Approach***

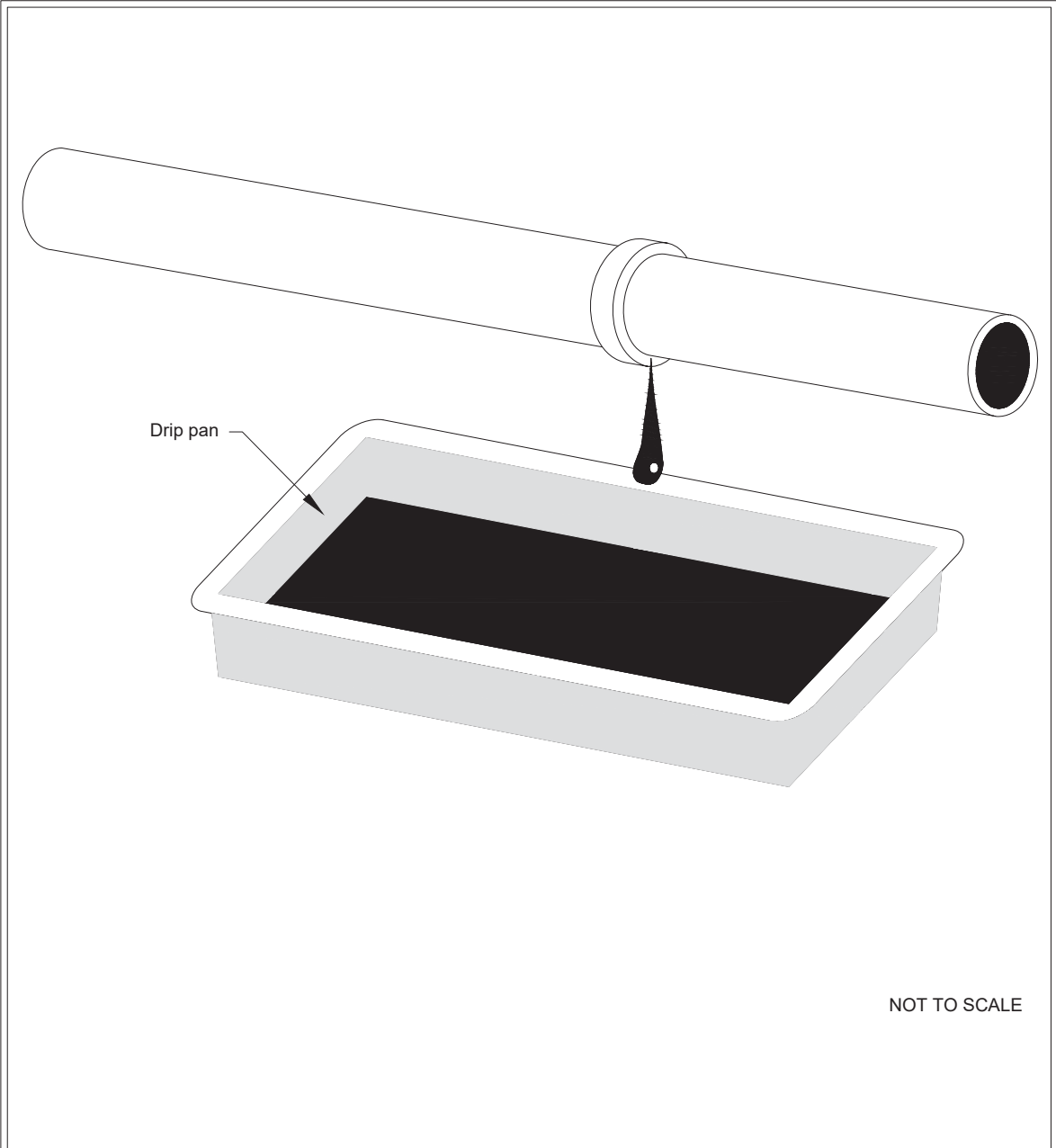
Cover and contain the loading/unloading area where necessary to prevent run-on of stormwater and runoff of contaminated stormwater.

### ***Applicable Operational BMPs***

#### **At All Loading/Unloading Areas**

- A significant amount of debris can accumulate at outside, uncovered loading/unloading areas. Sweep these surfaces frequently to remove loose material that could contaminate stormwater. Sweep areas temporarily covered after removal of the containers, logs, or other material covering the ground.
- Place drip pans, or other appropriate temporary containment device, at locations where leaks or spills may occur such as hose connections, hose reels, and filler nozzles. Always use drip pans when making and breaking connections (see [Figure 8.2: Drip Pan](#)). Check loading/unloading equipment such as valves, pumps, flanges, and connections regularly for leaks and repair as needed.

**Figure 8.2: Drip Pan**



DEPARTMENT OF  
**ECOLOGY**  
State of Washington

### Drip Pan

Revised June 2016

Please see <http://www.ecy.wa.gov/copyright.html> for copyright notice including permissions, limitation of liability, and disclaimer.

### **At Tanker Truck and Rail Transfer Areas to Aboveground/Belowground Storage Tanks**

- To minimize the risk of accidental spillage, prepare an “operations plan” that describes procedures for loading/unloading. Train the employees, especially forklift operators, in its execution and post it or otherwise have it readily available to all employees.
- Report spills of reportable quantities to Ecology.
- Prepare and implement a spill prevention control and countermeasures (SPCC) plan for the facility (see [S426E: BMPs for Spills of Oil and Hazardous Substances](#)), which includes the following BMPs:
  - Ensure the cleanup of liquid/solid spills in the loading/unloading area immediately, if a significant spill occurs, and, upon completion of the loading/unloading activity, or, at the end of the workday.
  - Retain and maintain an appropriate oil spill kit on-site for rapid cleanup of material spills. (See [S426E: BMPs for Spills of Oil and Hazardous Substances](#).)
  - Ensure that an employee trained in spill containment and cleanup is present during loading/unloading.

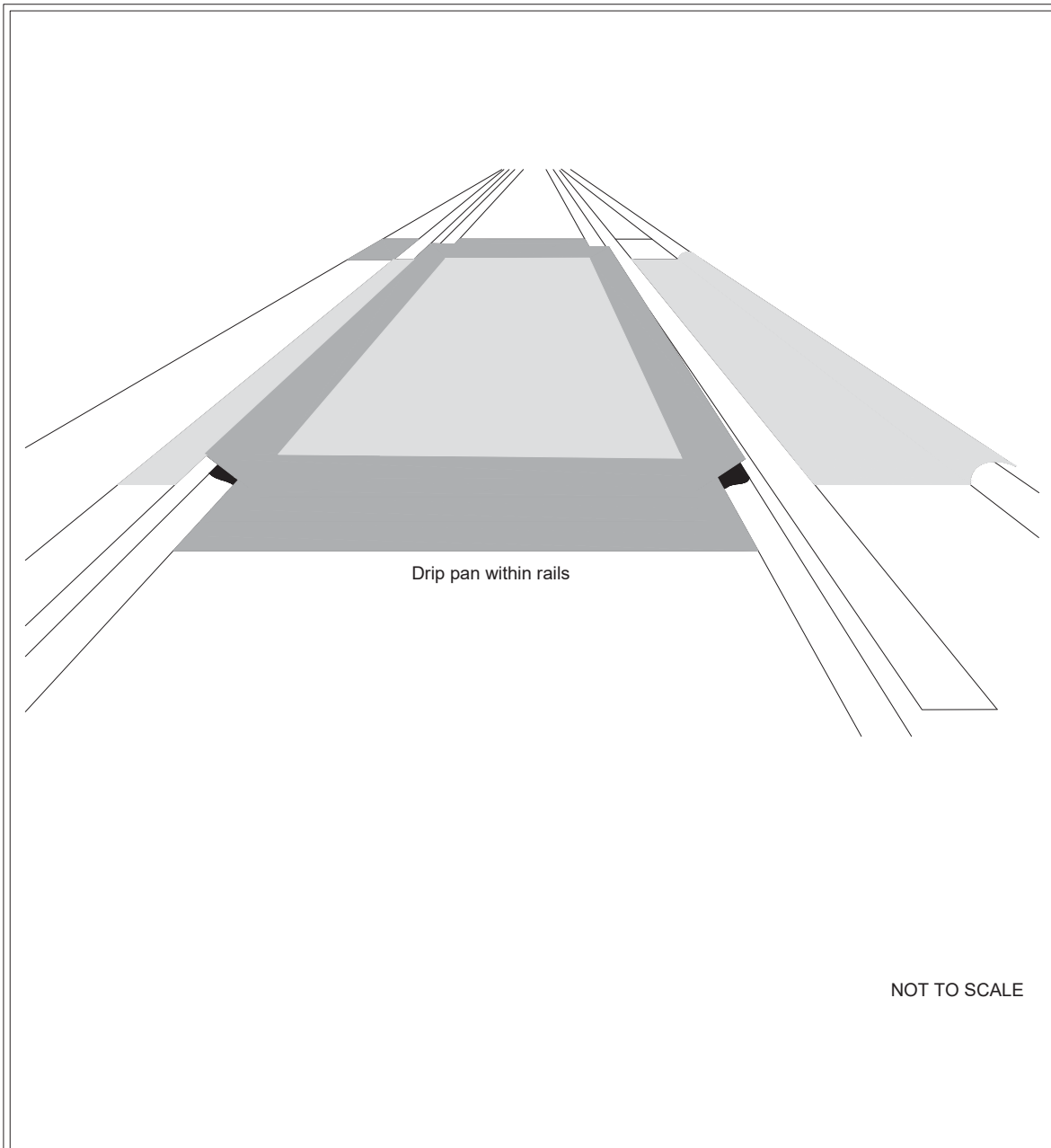
### **At Rail Transfer Areas to Aboveground/Belowground Storage Tanks**

Install a drip pan system as illustrated (see [Figure 8.3: Drip Pan within Rails](#)) within the rails to collect spills/leaks from tank cars and hose connections, hose reels, and filler nozzles.

### ***Transfer of Small Quantities from Tanks and Containers***

See [S428E: BMPs for Storage of Liquids in Permanent Aboveground Tanks](#) and [S427E: BMPs for Storage of Liquid, Food Waste, or Dangerous Waste Containers](#) for requirements related to the transfer of small quantities from tanks and containers, respectively.

**Figure 8.3: Drip Pan within Rails**



## Drip Pan within Rails

Revised June 2016

Please see <http://www.ecy.wa.gov/copyright.html> for copyright notice including permissions, limitation of liability, and disclaimer.

## ***Applicable Structural Source Control BMPs***

### **At All Loading/Unloading Areas**

Storage of flammable, ignitable, and reactive chemicals and materials must comply with the stricter of the local zoning codes, the local fire codes, the Uniform Fire Code (UFC), the UFC standards, or the National Electric Code. Consistent with UFC requirements and to the extent practicable, conduct unloading or loading of solids and liquids in a manufacturing building or under a roof, lean-to, or other appropriate cover.

- Berm, dike, and/or slope the loading/unloading area to prevent run-on of stormwater and to prevent the runoff or loss of any spilled material from the area.
- Place curbs along the edge of the loading/unloading areas or slope the edge such that the stormwater can flow to an internal drainage system that leads to an approved runoff treatment BMP. Avoid draining directly to the surface water from loading/unloading areas.
- Pave and slope loading/unloading areas to prevent the pooling of water. Minimize the use of catch basins and drain lines within the interior of the paved area or place catch basins in designated “alleyways” that are not covered by material, containers, or equipment.
- Retain on-site the necessary materials for rapid cleanup of spills.

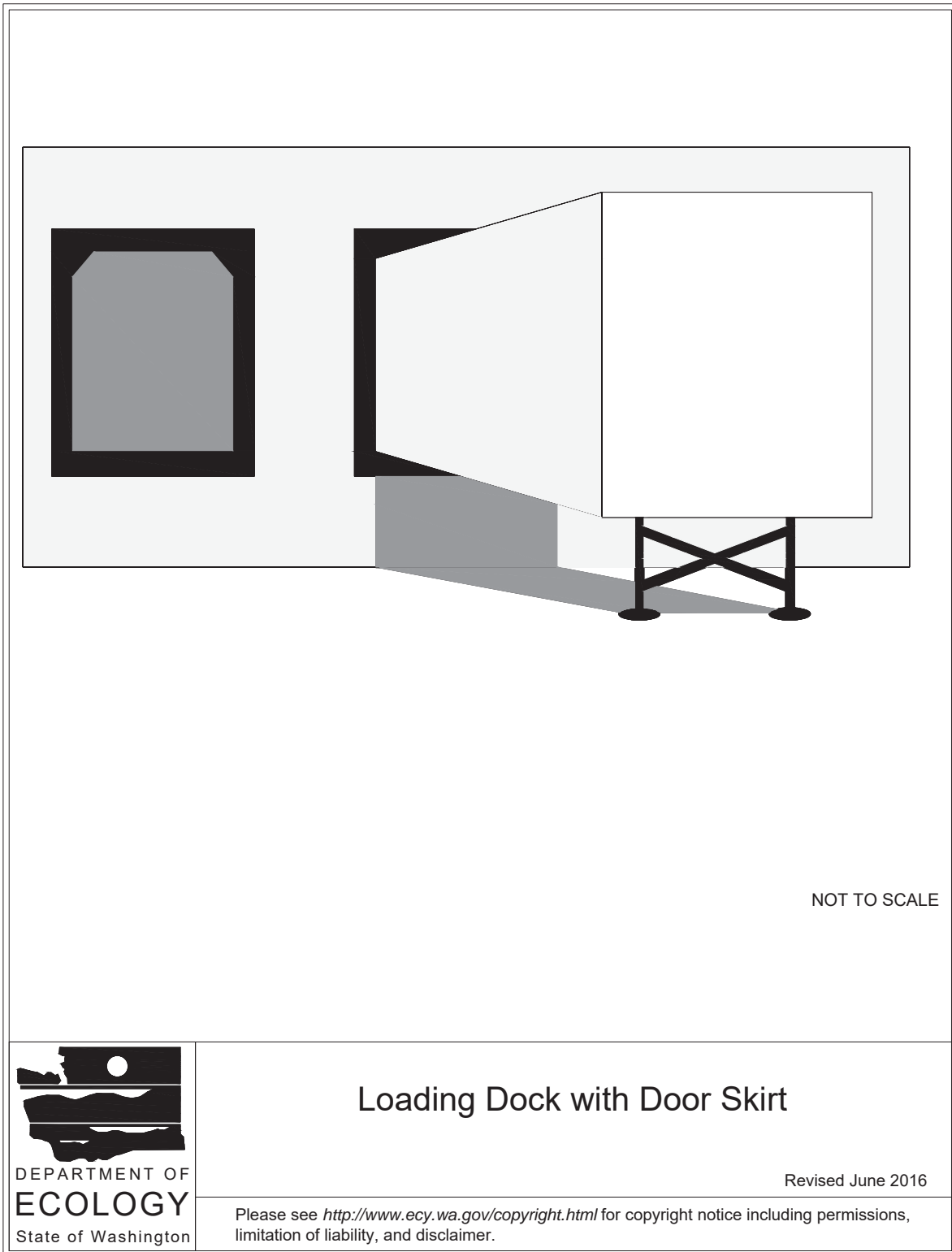
### ***Recommended Structural Source Control BMP***

For the transfer of pollutant liquids in areas that cannot contain a catastrophic spill, install an automatic shutoff system in case of unanticipated off-loading interruption (e.g., coupling break, hose rupture, overfill, etc.).

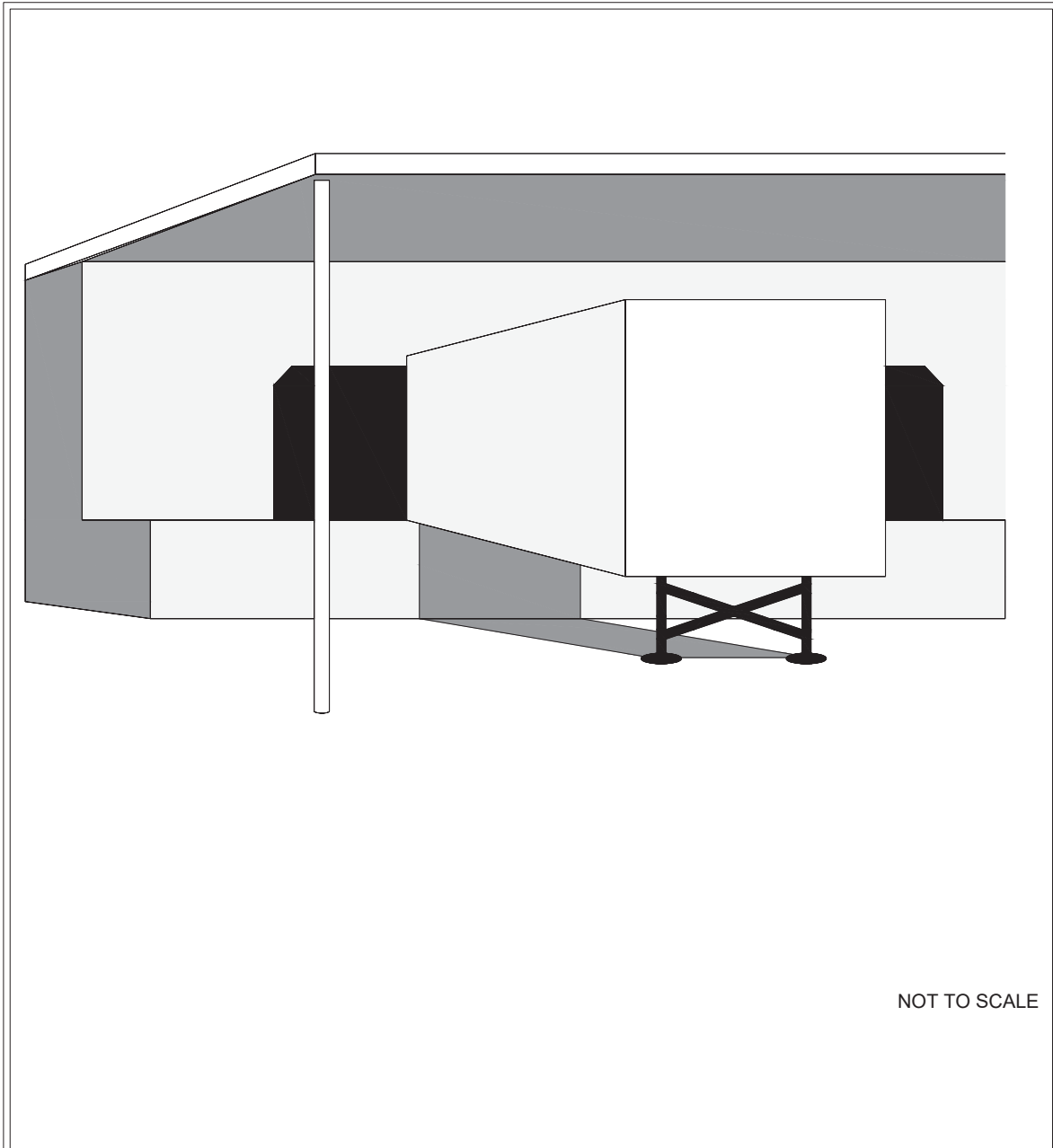
### **At Loading and Unloading Docks**

- Install/maintain overhangs or door skirts that enclose the trailer end (see [Figure 8.4: Loading Dock with Door Skirt](#) and [Figure 8.5: Loading Dock with Overhang](#)) to prevent contact with rainwater.
- Design the loading/unloading area with berms, sloping, etc., to prevent the run-on of stormwater.

**Figure 8.4: Loading Dock with Door Skirt**



**Figure 8.5: Loading Dock with Overhang**



NOT TO SCALE



## Loading Dock with Overhang

Revised June 2016

Please see <http://www.ecy.wa.gov/copyright.html> for copyright notice including permissions, limitation of liability, and disclaimer.



## **At Tanker Truck Transfer Areas to Aboveground/Belowground Storage Tanks**

- Pave the area on which the transfer takes place. If any transferred liquid, such as gasoline, is reactive with asphalt, pave the area with Portland cement concrete.
- Slope, berm, or dike the transfer area to a dead-end sump, spill containment sump, an oil and water separator, or other spill control device. The minimum spill retention time should be 15 minutes at the greater flow rate of the highest fuel dispenser nozzle through-put rate, or the peak flow rate of the 6-month, 24-hour storm event over the surface of the containment pad, whichever is greater. The capacity of the spill containment sump should be a minimum of 50 gallons with additional capacity provided for grit sedimentation.

## **S413E: BMPs for Log Sorting and Handling**

### ***Description of Pollutant Sources***

Log yards are paved or unpaved areas where logs are transferred, sorted, debarked, cut, and stored to prepare them for shipment or for the production of dimensional lumber, plywood, chips, poles, or other products. Log yards are generally maintained at sawmills, shipping ports, and pulp mills. Typical pollutants include oil and grease, biochemical oxygen demand, settleable solids, total suspended solids, high and low pH, heavy metals, pesticides, wood-based debris, and leachate.

The following are pollutant sources:

- Log storage, rollout, sorting, scaling, and cutting areas
- Log and liquid loading areas
- Log sprinkling
- Debarking, bark bin and conveyor areas
- Bark, ash, sawdust and wood debris piles, and solid wastes
- Metal salvage areas
- Truck, rail, ship, stacker, and loader access areas
- Log trucks, stackers, loaders, forklifts, and other heavy equipment
- Maintenance shops and parking areas
- Cleaning areas for vehicles, parts, and equipment
- Storage and handling areas for hydraulic oils, lubricants, fuels, paints, liquid wastes, and other liquid materials
- Pesticide usage for log preservation and surface protection
- Application of herbicides for weed control
- Contaminated soil resulting from leaks or spills of fluids

## ***Ecology's Baseline General Permit Requirements***

Industries with log yards or areas where logs are sorted or loaded are required to obtain coverage under the Industrial Stormwater General Permit for discharges of stormwater associated with industrial activities to receiving water. The permit requires preparation and on-site retention of an Industrial Stormwater Pollution Prevention Plan (SWPPP). The SWPPP must identify operational, source control, erosion and sediment control and, if necessary, runoff treatment BMPs. Required and recommended operational source control, structural source control, and runoff treatment BMPs are presented in detail in *Industrial Stormwater General Permit Implementation Manual for Log Yards* ([Ecology, 2016b](#)).

### **S414E: BMPs for Maintenance and Repair of Vehicles and Equipment**

#### ***Description of Pollutant Sources***

Pollutant sources include parts/vehicle cleaning, spills/leaks of fuel and other liquids, replacement of liquids, outdoor storage of batteries/liquids/parts, and vehicle parking.

#### ***Pollutant Control Approach***

Control of leaks and spills of fluids using good housekeeping and cover and containment BMPs.

#### ***Applicable Operational BMPs***

- Inspect all incoming vehicles, parts, and equipment stored temporarily outside for leaks.
- Use drip pans or containers under parts or vehicles that drip or that are likely to drip liquids, such as during dismantling of liquid containing parts, or removal or transfer of liquids.
- Remove batteries and liquids from vehicles and equipment in designated areas designed to prevent stormwater contamination. Store cracked batteries in a covered nonleaking secondary containment system.
- Remove liquids from vehicles retired for scrap.
- Empty oil and fuel filters before disposal. Provide for proper disposal of waste oil and fuel.
- Do not pour/convey washwater, liquid waste, or other pollutants into storm drains or receiving water. Check with the local sanitary sewer authority for approval to convey water to a sanitary sewer.
- Do not connect maintenance and repair shop floor drains to storm drains or to surface water.
- To allow for snowmelt during the winter, install a drainage trench with a sump for particulate collection. Use the drainage trench for draining the snowmelt only. Do not discharge any vehicular or shop pollutants to the trench drain.

#### ***Applicable Structural Source Control BMPs***

- Conduct all maintenance and repair of vehicles and equipment in a building or other covered impervious containment area that is sloped to prevent run-on of uncontaminated stormwater

and runoff of contaminated water.

- Operators may conduct maintenance of refrigeration engines in refrigerated trailers in the parking area. Exercise due caution to avoid the release of engine or refrigeration fluids to storm drains or receiving water.
- Park large mobile equipment, such as log stackers, in a designated contained area.

### ***Additional Applicable BMPs***

- [S409E: BMPs for Fueling at Dedicated Stations](#)
- [S108E: BMPs for Correcting Illicit Connections to Storm Drains](#)
- [S412E: BMPs for Loading and Unloading Areas for Liquid or Solid Material](#)
- [S426E: BMPs for Spills of Oil and Hazardous Substances](#)
- [S427E: BMPs for Storage of Liquid, Food Waste, or Dangerous Waste Containers](#)
- [S428E: BMPs for Storage of Liquids in Permanent Aboveground Tanks](#)
- [S429E: BMPs for Storage or Transfer \(Outside\) of Solid Raw Materials, By-Products, or Finished Products](#)
- [S431E: BMPs for Washing and Steam Cleaning Vehicles/Equipment/Building Structures](#)

### ***Applicable Runoff Treatment BMPs***

Convey contaminated stormwater runoff from vehicle staging and maintenance areas to a sanitary sewer, if allowed by the local sewer authority, or to an American Petroleum Institute or coalescing plate oil and water separator followed by a basic treatment BMP (see [Chapter 5 - Runoff Treatment BMP Design](#)), applicable filter, or other equivalent oil treatment system.

**Note:** A runoff treatment BMP may be necessary for contaminated stormwater.

### ***Recommended Operational BMPs***

- Store damaged vehicles inside a building or other covered containment, until successfully removing all liquids.
- Clean parts with aqueous detergent based solutions or nonchlorinated solvents such as kerosene or high-flash mineral spirits, and/or use wire brushing or sand blasting whenever practicable. Avoid using toxic liquid cleaners such as methylene chloride, 1,1,1-trichloroethane, trichloroethylene, or similar chlorinated solvents. Choose cleaning agents that can be recycled.
- Inspect all BMPs regularly, particularly after a significant storm. Identify and correct deficiencies to ensure that the BMPs are functioning as intended.
- Avoid hosing down work areas. Use dry methods for cleaning leaked fluids.
- Recycle greases, used oil, oil filters, antifreeze, cleaning solutions, automotive batteries,

hydraulic fluids, transmission fluids, and engine oils. See the Washington State Department of Ecology's Hazardous Waste and Toxics Reduction Program at the following web address for recommendations on recycling or disposal of vehicle waste liquids and other waste materials:

<https://ecology.wa.gov/About-us/Get-to-know-us/Our-Programs/Hazardous-Waste-Toxics-Reduction>

- Do not mix dissimilar or incompatible waste liquids stored for recycling.

## **S415E: BMPs for Maintenance of Public and Private Utility Corridors and Facilities**

### ***Description of Pollutant Sources***

Corridors and facilities at petroleum product pipelines, natural gas pipelines, water pipelines, and electrical power transmission corridors and rights-of-way can be sources of pollutants such as herbicides used for vegetation management, and eroded soil particles from unpaved access roads. At pump stations, waste materials generated during maintenance activities may be temporarily stored outside. Additional potential pollutant sources include the leaching of preservatives from wood utility poles, polychlorinated biphenyls (PCBs) in older transformers, water removed from underground transformer vaults, and leaks/spills from petroleum pipelines. The following are potential pollutants: oil and grease, total suspended solids, biochemical oxygen demand, organics, PCBs, pesticides, and heavy metals.

### ***Pollutant Control Approach***

Implementation of spill control plans as well as control of fertilizer and pesticide applications, soil erosion, and site debris that can contaminate stormwater.

### ***Applicable Operational BMPs***

- Minimize the amount of herbicides and other pesticides used to maintain access roads and facilities.
- Implement [S411E: BMPs for Landscaping and Lawn/Vegetation Management](#) and the requirements in [1.4.12 WSDA Pesticide Regulations](#).
- When removing water or sediments are removed from electric transformer vaults, determine the presence of contaminants before disposing of the water and sediments.
  - This includes inspecting for the presence of oil or sheen and determining from records or testing if the transformers contain PCBs.
  - If records or tests indicate that the sediments or water are contaminated above applicable levels, manage these media in accordance with applicable federal and state regulations, including the federal PCB rules ([40 CFR Part 761](#)) and the state Model Toxics Control Act (MTCA) cleanup regulations ([Chapter 173-340 WAC](#)).
  - Water removed from the vaults can be discharged in accordance with the federal regulations [40 CFR 761.79](#) and state regulations ([Chapter 173-201A WAC](#) and [Chapter 173-200 WAC](#)) or via the sanitary sewer if the requirements, including

applicable permits, for such a discharge are met. (See [1.4.13 Stormwater Discharges to Public Sanitary Sewers, Septic Systems, Dead-End Sumps, and Industrial Waste Treatment Systems.](#))

- Stabilize access roads or areas of bare ground with gravel, crushed rock, or another method to prevent erosion. Use and manage vegetation to minimize bare ground/soils that may be susceptible to erosion.
- Provide maintenance practices to prevent stormwater from accumulating and draining across and/or onto roadways. Convey stormwater through roadside ditches and culverts. The road should be crowned, sloped outward, water barred, or otherwise left in a condition not conducive to erosion. Appropriately maintaining grassy roadside ditches discharging to surface waters is an effective way of removing some pollutants associated with sediments carried by stormwater.
- Maintain ditches and culverts at an appropriate frequency to ensure that plugging and flooding across the roadbed, with resulting overflow erosion, does not occur.
- Apply the appropriate BMPs in this chapter for the storage of waste materials that can contaminate stormwater.

### ***Recommended Operational BMPs***

- When selecting utility poles for a specific location, consider the potential environmental effects of the pole or poles during storage, handling, and end-use, as well as its cost, safety, efficacy, and expected life. Use wood products treated with chemical preservatives made in accordance with generally accepted industry standards such as the American Wood Preservers Association Standards. Consider alternative materials or technologies if placing poles in or near an environmentally sensitive area, such as a wetland or a drinking water well. Alternative technologies include poles constructed with material(s) other than wood such as fiberglass composites, metal, or concrete. Consider other technologies and materials, such as sleeves or caissons for wood poles, when they are determined to be practicable and available.
- As soon as practicable remove all litter from wire cutting/replacing operations.
- Implement temporary erosion and sediment control in areas cleared of trees and vegetation and during the construction of new roads.

## **S416E: BMPs for Maintenance of Roadside Ditches**

### ***Description of Pollutant Sources***

Common road debris including eroded soil, oils, vegetative particles, and heavy metals can be a source of stormwater pollutants.

### ***Pollutant Control Approach***

Maintain roadside ditches to preserve the condition and capacity for which they were originally constructed, and to minimize bare or thinly vegetated ground surfaces. Maintenance practices should provide for erosion and sediment control (see [S411E: BMPs for Landscaping and Lawn/Vegetation Management](#)).

## ***Additional Regulations***

Note that work in wet areas may be regulated by local, state, or federal regulations that impose additional obligations on the responsible party. Check with the appropriate authorities prior to beginning work in those areas.

## ***Applicable Operational BMPs***

- Inspect roadside ditches regularly to identify sediment accumulations and localized erosion.
- Clean ditches on a regular basis, as needed. Keep ditches free of rubbish and debris.
- Vegetation in ditches often prevents erosion and cleanses runoff waters. Remove vegetation only when flow is blocked or excess sediments have accumulated. Conduct ditch maintenance (seeding, fertilizer application, harvesting) in late spring and/or early fall, where possible. This allows reestablishment of vegetative cover by the next wet season thereby minimizing erosion of the ditch as well as making the ditch effective as a biofiltration swale or filter strip.
- Do not apply fertilizer unless needed to maintain vegetative growth.
- In the area between the edge of the pavement and the bottom of the ditch, commonly known as the “bare earth zone,” use grass vegetation, wherever possible. Establish vegetation from the edge of the pavement, if possible, or at least from the top of the slope of the ditch.
- Maintain diversion ditches on top of cut slopes that are constructed to prevent slope erosion by intercepting surface drainage to retain their diversion shape and capability.
- Use temporary erosion and sediment control measures or revegetate as necessary to prevent erosion during ditch reshaping.
- Do not leave ditch cleanings on the roadway surfaces. Sweep, collect, and dispose of dirt and debris remaining on the pavement at the completion of ditch cleaning operations.
  - Consider screening roadside ditch cleanings, not contaminated by spills or other releases and not associated with a runoff treatment BMP such as a biofiltration swale, to remove litter. Separate screenings into soil and vegetative matter (leaves, grass, needles, branches, etc.) categories. Compost or dispose of the vegetative matter in a municipal waste landfill. Consult with the jurisdictional health department to discuss use or disposal options for the soil portion. For more information, see [Appendix 8-B: Management of Street Waste Solids and Liquids](#).
  - Roadside ditch cleanings contaminated by spills or other releases known or suspected, to contain dangerous waste must be handled following the Dangerous Waste Regulations ([Chapter 173-303 WAC](#)). If testing determines materials are not dangerous waste but contaminants are present, consult with the jurisdictional health department for disposal options.
- Examine culverts on a regular basis for scour or sedimentation at the inlet and outlet, and repair as necessary. Give priority to those culverts conveying perennial and/or salmon-bearing streams and culverts near streams in areas of high sediment load, such as those near

subdivisions during construction. Maintain trash racks to avoid damage, blockage, or erosion of culverts.

### ***Recommended Runoff Treatment BMPs***

- Install biofiltration swales and filter strips (see [Chapter 5 - Runoff Treatment BMP Design](#)) to treat roadside runoff, wherever practicable, and use engineered topsoil wherever necessary to maintain adequate vegetation. These systems can improve infiltration and stormwater pollutant control upstream of roadside ditches.

## **S417E: BMPs for Maintenance of Drainage Systems and Runoff Treatment BMPs**

### ***Description of Pollutant Sources***

Facilities include roadside catch basins on arterials and within residential areas, drainage systems, detention BMPs such as ponds and vaults, oil and water separators, biofiltration swales, filter strips, settling basins, infiltration systems, and all other types of runoff treatment BMPs presented in [Chapter 5 - Runoff Treatment BMP Design](#). Oil and grease, hydrocarbons, debris, heavy metals, sediments, and contaminated water are found in catch basins, oil and water separators, and settling basins.

### ***Pollutant Control Approach***

Provide maintenance and cleaning of debris, sediments, and oil from drainage systems and runoff treatment BMPs to obtain proper operation.

### ***Applicable Operational BMPs***

Maintain runoff treatment BMPs per the operation and maintenance (O&M) procedures presented in [Appendix 5-A: Recommended Maintenance Criteria for Runoff Treatment BMPs](#) and [Appendix 6-A: Recommended Maintenance Criteria for Flow Control BMPs](#) of this manual in addition to the following BMPs:

- Inspect and clean runoff treatment BMPs, drainage systems, and catch basins, as needed, and determine necessary O&M improvements.
- Promptly repair any deterioration threatening the structural integrity of stormwater BMPs. These include replacement of clean-out gates, catch basin lids, and rocks in emergency spillways.
- Ensure adequacy of storm drain capacities and prevent heavy sediment discharges to the drainage system.
- Regularly remove debris and sludge from BMPs used for peak-rate control, treatment, etc., and discharge to a sanitary sewer, if approved by the local sewer authority, or truck to a disposal site that is approved by the local jurisdiction or state government.
- Clean catch basins when the depth of deposits reaches 60% of the sump depth as measured from the bottom of basin to the invert of the lowest pipe into or out of the basin. However, in no case should there be < 6 inches clearance from the debris surface to the invert of the lowest

pipe. Some catch basins (e.g., Washington State Department of Transportation Type 1L basins) may have as little as 12 inches sediment storage below the invert. These catch basins need frequent inspection and cleaning to prevent scouring. Where these catch basins are part of a drainage system, the system owner/operator may choose to concentrate maintenance efforts on downstream control devices as part of a systems approach.

- Clean woody debris in a catch basin as frequently as needed to ensure proper operation of the catch basin.
- Post warning signs “Dump No Waste – Drains to Ground Water,” “Streams,” “Lakes,” or emboss on or adjacent to all storm drain inlets where possible (see [S442E: BMPs for Labeling Storm Drain Inlets on Your Property](#)).
- Disposal of sediments and liquids from the catch basins must comply with BMPs for Managing Street Waste (see [Appendix 8-B: Management of Street Waste Solids and Liquids](#)).

### ***Additional Applicable BMPs***

Depending on the pollutant sources and activities conducted at the facility, select additional applicable BMPs from this list:

- [S425E: BMPs for Soil Erosion and Sediment Control at Industrial Sites](#)
- [S427E: BMPs for Storage of Liquid, Food Waste, or Dangerous Waste Containers](#)
- [S426E: BMPs for Spills of Oil and Hazardous Substances](#)
- [S108E: BMPs for Correcting Illicit Connections to Storm Drains](#)
- [S430E: BMPs for Urban Streets](#)

## **S418E: BMPs for Manufacturing Activities – Outside**

### ***Description of Pollutant Sources***

Manufacturing pollutant sources include outside process areas, stack emissions, and areas where manufacturing activity has taken place in the past and significant exposed pollutant materials remain.

### ***Pollution Control Approach***

Cover and contain outside manufacturing and prevent stormwater run-on and contamination, where feasible.

### ***Applicable Operational BMP***

- Sweep paved areas regularly, as needed, to prevent contamination of stormwater.
- Alter the activity by eliminating or minimizing the contamination of stormwater.

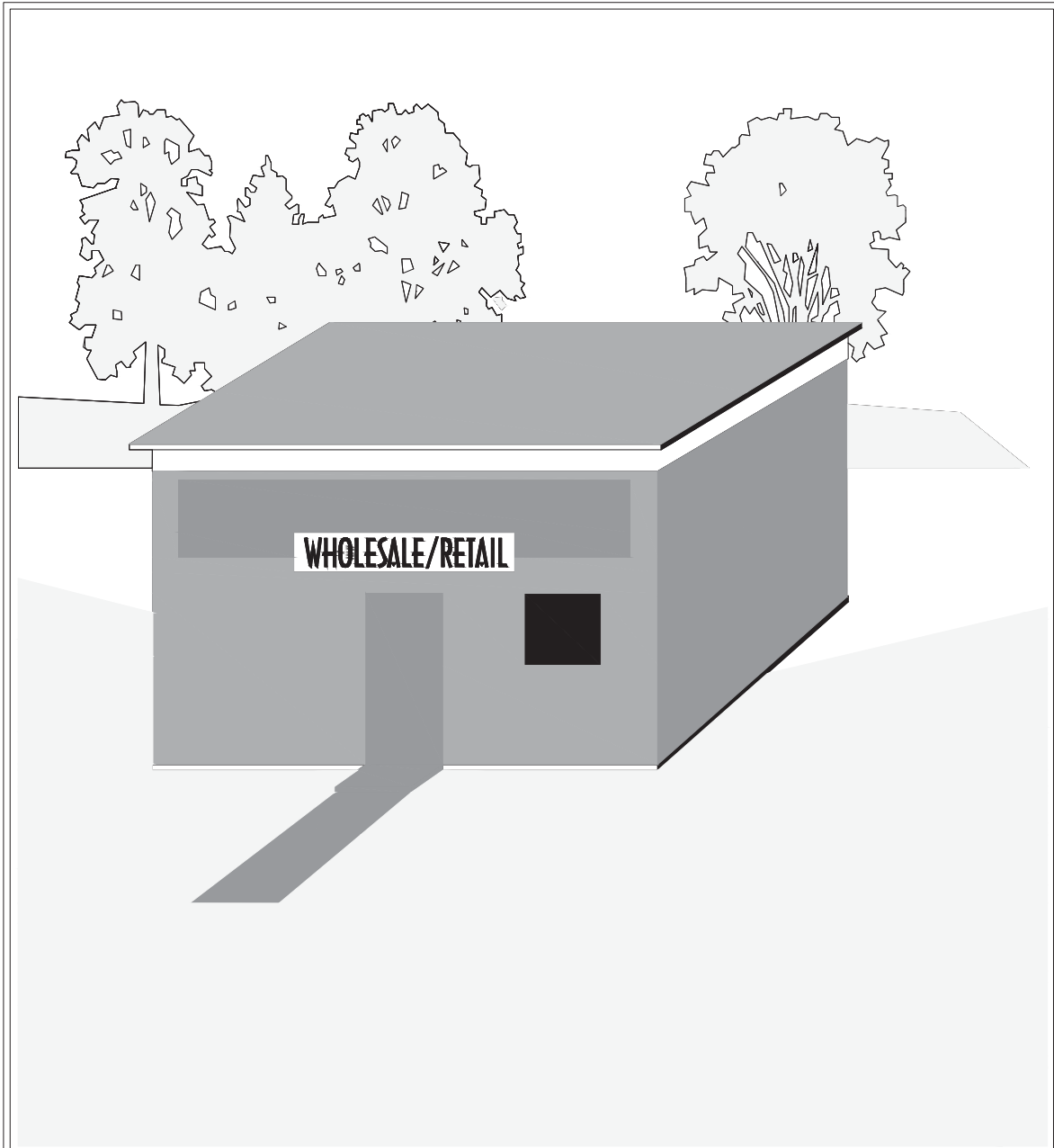
### ***Applicable Structural Source Control BMPs***

- Enclose the activity (see [Figure 8.6: Enclose the Activity](#)). If possible, enclose the manufacturing activity in a building.



- Cover the activity and connect floor drains to a sanitary sewer, if approved by the local sewer authority. Berm or slope the floor, as needed, to prevent drainage of pollutants to outside areas (see [Figure 8.7: Cover the Activity](#)).
- Isolate and segregate pollutants, as feasible. Convey the segregated pollutants to a sanitary sewer, process treatment, or a dead-end sump, depending on available methods and applicable permit requirements.

**Figure 8.6: Enclose the Activity**

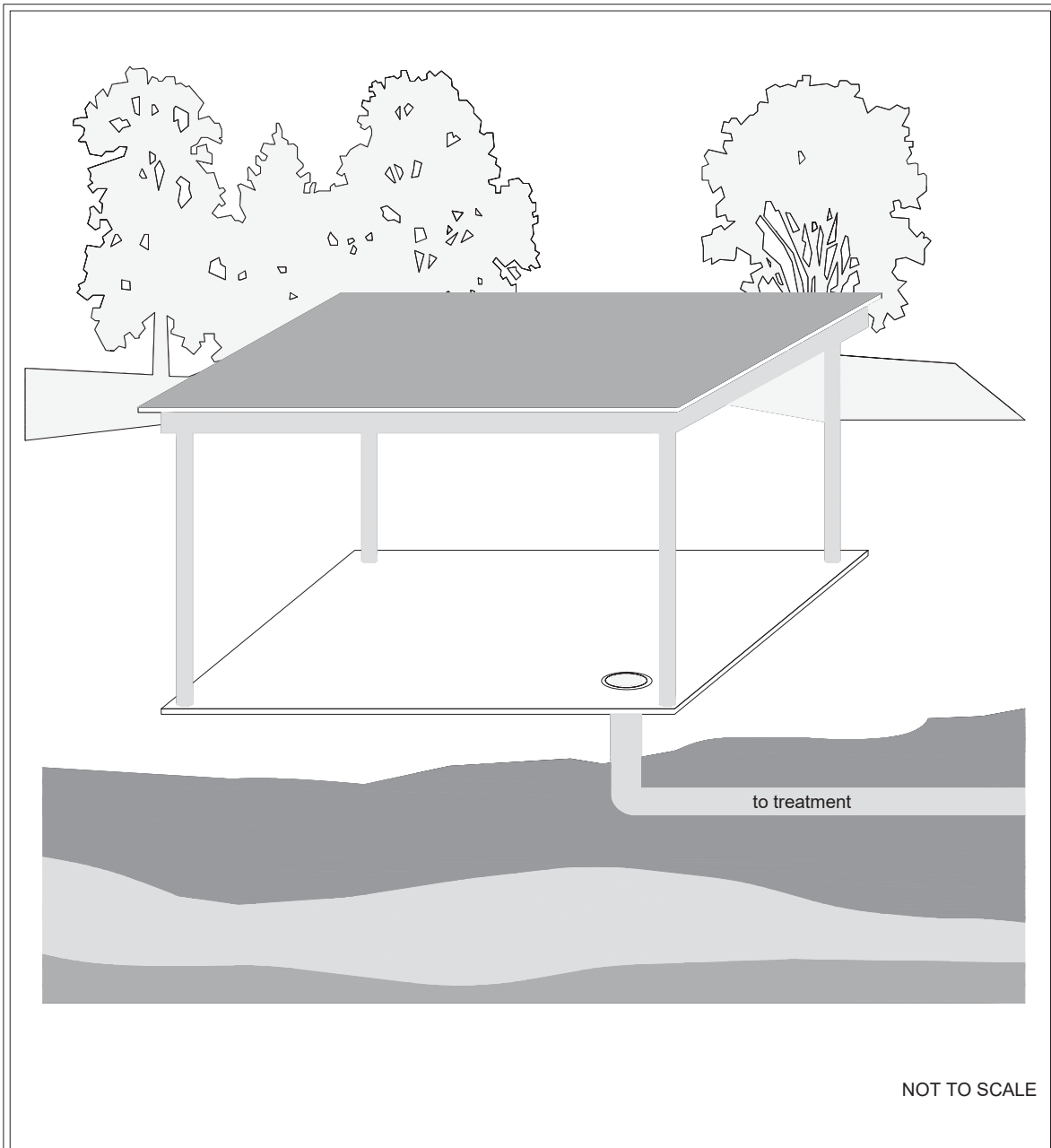


## Enclose the Activity

Revised June 2016

Please see <http://www.ecy.wa.gov/copyright.html> for copyright notice including permissions, limitation of liability, and disclaimer.

**Figure 8.7: Cover the Activity**



## Cover the Activity

Revised June 2016

Please see <http://www.ecy.wa.gov/copyright.html> for copyright notice including permissions, limitation of liability, and disclaimer.

## **S419E: BMPs for Mobile Fueling of Vehicles and Heavy Equipment**

### ***Description of Pollutant Sources***

Mobile fueling, also known as fleet fueling, wet fueling, or wet hosing, is the practice of filling fuel tanks of vehicles by tank trucks that are driven to the yards or sites where the vehicles to be fueled are located. Diesel fuel is categorized as a Class II combustible liquid, whereas gasoline is categorized as a flammable liquid ([49 CFR 173.2](#)).

**Note:** Some local fire departments may have restrictions on mobile fueling practices.

Historically organizations conducted mobile fueling for off-road vehicles operated for extended periods in remote areas. This includes construction sites, logging operations, and farms. Some organizations conduct mobile fueling of on-road vehicles is also conducted commercially in the state of Washington.

### ***Pollutant Control Approach***

Fueling operators need proper training of fueling operations, the use of spill/drip control, and fuel transfer procedures.

### ***Applicable Operational BMPs***

Organizations and individuals conducting mobile fueling operations must implement the BMPs in the following list. The operating procedures for the driver/operator should be simple, clear, effective, and their implementation verified by the organization liable for environmental and third-party damage.

- Ensure that the local fire department approves all mobile fueling operations. Comply with local and Washington State fire codes.
- In fueling locations that are in proximity to sensitive aquifers, designated wetlands, wetland buffers, or other waters of the state, approval by local jurisdictions is necessary to ensure compliance with additional local requirements.
- Ensure the compliance with all [49 CFR Part 178](#) requirements for a U.S. Department of Transportation (DOT) 406 cargo tanker. Documentation from a DOT-registered inspector provides proof of compliance.
- Ensure the presence and the constant observation/monitoring of the driver/operator at the fuel transfer location at all times during fuel transfer, and ensure implementation of the following procedures at the fuel transfer locations:
  - Locate the point of fueling  $\geq 25$  feet from the nearest storm drain or inside an impervious containment with a volumetric holding capacity  $\geq 110\%$  of the fueling tank volume, or covering the storm drain to ensure no inflow of spilled or leaked fuel. Covers are not required for storm drains that convey the inflow to a spill control separator, approved by the local jurisdiction and the fire department. Potential spill/leak conveyance surfaces must be impervious and in good repair. Do not remove the drain cover if sheen is present. Properly collect and dispose of any contaminated material.
  - Place a drip pan or an absorbent pad under each fueling location prior to and during all

dispensing operations. The pan (must be liquid tight), and the absorbent pad must have a capacity of  $\geq 5$  gallons. There is no need to report spills retained in the drip pan or the pad.

- Manage the handling and operation of fuel transfer hoses and nozzle, drip pan(s), and absorbent pads as needed to prevent spills/leaks of fuel from reaching the ground, storm drains, and receiving waters.
- Avoid extending the fueling hoses across a traffic lane without fluorescent traffic cones, or equivalent devices, conspicuously placed to prevent all traffic from crossing the fuel hose.
- Remove the fill nozzle and cease filling the tank when the automatic shutoff valve engages. Do not lock automatic shutoff fueling nozzles in the open position.
- Do not “top off” the fuel receiving equipment.
- Provide the driver/operator of the fueling vehicle with the following:
  - Adequate flashlights or other mobile lighting to view fuel fill openings with poor accessibility. Consult with local fire department for additional lighting requirements.
  - Two-way communication with his/her home base.
- Train the driver/operator annually in spill prevention and cleanup measures and emergency procedures. Make all employees aware of the significant liability associated with fuel spills.
- The responsible manager shall properly sign and date the fueling operating procedures. Distribute procedures to the operators, retain them in the organization files, and make them available in the event an authorized government agency requests a review.
- Immediately notify the local fire department (911) and the appropriate regional office of the Washington State Department of Ecology in the event of any spill entering surface or ground waters. Establish a “call down list” to ensure the rapid and proper notification of management and government officials should any significant amount of product be lost off-site. Keep the list in a protected but readily accessible location in the mobile fueling truck. The “call down list” should also identify spill response contractors available in the area to ensure the rapid removal of significant product spillage into the environment.
- In all fueling vehicles, maintain a minimum of the following spill cleanup materials:
  - Non-water-absorbents capable of absorbing  $\geq 15$  gallons of fuel
  - A storm drain plug or cover kit
  - A non-water-absorbent containment boom of a minimum 10 feet in length with a 12-gallon minimum absorbent capacity
  - A non-spark-generating shovel (a steel shovel could generate a spark and cause an explosion in the right environment around a spill)
  - Two 5-gallon buckets with lids

- Use automatic shutoff nozzles for dispensing the fuel. Replace automatic shutoff nozzles as recommended by the manufacturer.
- Maintain and replace equipment on fueling vehicles, particularly hoses and nozzles, at established intervals to prevent failures.
- Immediately remove and properly dispose of soils with visible surface contamination to prevent the spread of chemicals to ground water or receiving waters via stormwater runoff.
- Do not use dispersants to clean up spills or sheens.

### ***Applicable Structural Source Control BMPs***

Include the following fuel transfer site components:

- Automatic fuel transfer shutoff nozzles
- An adequate lighting system at the filling point

## **S420E: BMPs for Painting/Finishing/Coating of Vehicles/Boats/Buildings/Equipment**

### ***Description of Pollutant Sources***

Surface preparation and the application of paints, finishes and/or coatings to vehicles, boats, buildings, and/or equipment outdoors can be sources of pollutants. Potential pollutants include organic compounds, oils and greases, heavy metals, and suspended solids.

### ***Pollutant Control Approach***

Cover and contain painting and sanding operations and apply good housekeeping and preventive maintenance practices to prevent the contamination of stormwater with painting over sprays and grit from sanding.

### ***Applicable Operational BMPs***

- Train employees in the careful application of paints, finishes, and coatings to reduce misuse and over spray. Use drop cloths underneath outdoor painting, scraping, sandblasting work, and properly clean and temporarily store collected debris daily.
- Do not conduct spraying, blasting, or sanding activities over open water, or where wind may blow paint into water.
- Wipe up spills with rags and other absorbent materials immediately. Do not hose down the area to a storm drain, receiving water, or conveyance ditch.
- On dock areas sweep rather than hose down debris. Collect any hose water generated and convey to appropriate treatment and disposal.
- Use a catch basin cover, filter sock, or other effective runoff control device if dust, grit, washwater, or other pollutants may escape the work area and enter a catch basin. The containment device(s) must be in place at the beginning of the workday. Collect contaminated

runoff and solids and properly dispose of such wastes before removing the containment device(s) at the end of the workday.

- Use a ground cloth, pail, drum, drip pan, tarpaulin, or other protective device for activities such as outdoor paint mixing and tool cleaning or where spills can contaminate stormwater.
- Properly dispose of all wastes and prevent all uncontrolled releases to the air, ground, or water.
- Clean paintbrushes and tools covered with water-based paints in sinks connected to sanitary sewers.
- Clean brushes and tools covered with non-water-based paints, finishes, or other materials in a manner that allows collection of used solvents (e.g., paint thinner, turpentine, and xylol) for recycling or proper disposal.
- Store toxic materials under cover (e.g., tarpaulin) during precipitation events and when not in use to prevent contact with stormwater.

### ***Applicable Structural Source Control BMPs***

- Enclose and/or contain all work while using a spray gun or conducting sand blasting and in compliance with applicable air pollution control, Occupational Safety and Health Administration (OSHA), and Washington Industrial Safety and Health Act (WISHA) requirements.
- Do not conduct outside spraying, grit blasting, or sanding activities during windy conditions that render containment ineffective.

### ***Recommended Operational BMPs***

- Dispose of water-based paints by drying them out and then placing them in the garbage. Do not dump pollutants collected in portable containers into a sanitary sewer drain or a storm drain.
- Recycle paint, paint thinner, solvents, pressure wash wastewater, and any other recyclable materials.
- Use efficient spray equipment such as electrostatic, air-atomized, high-volume/low-pressure, or gravity-feed spray equipment.
- Purchase recycled paints, paint thinner, solvents, and other products, if feasible.

## **S421E: BMPs for Parking and Storage of Vehicles and Equipment**

### ***Description of Pollutant Sources***

Public and commercial parking lots such as retail store, fleet vehicle (including rent-a-car lots and car dealerships), equipment sale and rental parking lots, and parking lot driveways can be sources of toxic hydrocarbons and other organic compounds, including oil and grease, metals, and suspended solids.

## ***Pollutant Control Approach***

If the parking lot is a high-use site for vehicles as defined under Applicable Runoff Treatment BMPs, provide appropriate oil removal equipment for the contaminated stormwater runoff.

## ***Applicable Operational BMPs***

- If a parking lot must be washed, discharge the washwater to a sanitary sewer, if allowed by the local sewer authority or other approved wastewater treatment system, or collect washwater for off-site disposal.
- Do not hose down the area to a storm drain or receiving water. Vacuum sweep parking lots, storage areas, and driveways regularly to collect dirt, waste, and debris.
- Clean up vehicle and equipment fluid drips and spills immediately.
- Place drip pans below inoperative or leaking vehicles and equipment in a manner that catches leaks or spills, including employee vehicles.

## ***Recommended Operational BMPs***

- Encourage employees to repair leaking personal vehicles.
- Encourage employees to carpool or use public transit through incentives.
- Encourage customers to use public transit by rewarding valid transit pass holders with discounts.
- Install catch basin inserts to collect excess sediment and oil if necessary. Inspect and maintain catch basin inserts to ensure they are working correctly.

## ***Applicable Runoff Treatment BMPs***

Establishments subjected to high-use intensity are significant sources of oil contamination of stormwater. Examples of potential high-use areas include customer parking lots at fast food stores, grocery stores, taverns, restaurants, large shopping malls, discount warehouse stores, quick-lubrication (lube) shops, and banks. If the pollution-generating impervious surface for a high-use site is > 5,000 square feet (sf), an oil control BMP from the oil control options in [5.1.3 Runoff Treatment Methods and BMPs](#) is necessary. A high-use site at a commercial or industrial establishment has one of the following characteristics ([Gaus, 1994](#)):

- Subjected to an expected average daily traffic count  $\geq$  100 vehicles per 1,000 sf of gross building area
- Subjected to storage of a fleet of  $\geq$  25 diesel vehicles that are > 10 tons gross weight (trucks, buses, trains, heavy equipment, etc.).

## **S422E: BMPs for Railroad Yards**

### ***Description of Pollutant Sources***

Pollutant sources can include the following:



- Drips/leaks of vehicle fluids onto the railroad bed
- Human waste disposal
- Litter
- Locomotive/railcar/equipment cleaning areas
- Fueling areas
- Outside material storage areas
- Erosion and loss of soil particles from the railroad bed
- Maintenance and repair activities at railroad terminals
- Switching and maintenance yards
- Herbicides used for vegetation management

Waste materials can include waste oil, solvents, degreasers, antifreeze solutions, radiator flush, acids, brake fluids, soiled rags, oil filters, sulfuric acid and battery sludges, and machine chips with residual machining oil and toxic fluids/solids lost during transit. Potential pollutants include oil and grease, total suspended solids, biochemical oxygen demand, organics, pesticides, and metals.

### ***Pollutant Control Approach***

Apply good housekeeping and preventive maintenance practices to control leaks and spills of liquids in railroad yard areas.

### ***Applicable Operational and Structural Source Control BMPs***

- Implement the applicable Best Management Practices (BMPs) in this chapter depending on the pollution-generating activities/sources at a railroad yard facility.
- Do not allow discharge to outside areas from toilets while a train is in transit. Use pump-out facilities to service these units.
- Use drip pans at hose/pipe connections during liquid transfer and other leak-prone areas.
- Discharge locomotive cooling systems only after the locomotive has stopped and at a location where the coolant can be collected, managed, and then disposed of properly.
- During maintenance, do not discard debris or waste liquids along the tracks or in railroad yards.
- Handle wastes generated from large-scale equipment cleaning, such as locomotive, track equipment, or axle cleaning operations, properly to avoid harming the environment and to comply with state and federal environmental regulations.
- Store any metal scrap generated from metal punching or other mechanical operations out of contact with stormwater. For larger metal scrap, see Applicable Runoff Treatment BMPs.
- Do not dump any water-based coolant from multipunch presses into storm drains.

- Place track mats under each rail/flange lubricator that is in service (see [Figure 8.8: Installed Railroad Track Mats](#)).
- Select cost-effective rail/flange lubricant that causes the least adverse environmental impact. Consider both the chemical composition of the lubricant and the likelihood of transfer off the rail during rain events.
- Record the date of installation of track mats and replace them once the outdoor life of the track mats has been reached or there are signs that pollutants are being transported off the mats. Routinely inspect all track mats for tears or saturation. Replace track mats as necessary due to tears or saturation. Dispose of saturated track mats properly.
- Install spill containment pans/trays at locomotive and railcar maintenance facilities, fueling areas, and switching yards to collect all spills under locomotives and other track equipment. Direct spills to an oil and water separator for treatment or collect spilled chemicals for proper disposal.
- During locomotive fueling and inspection, use drip pans to capture any fuel or oil seepage.
- Place oil absorbent track mats beneath engines when they are parked outdoors.
- Do not conduct heavy/major locomotive engine repairs on the rail line. Conduct heavy/major engine repairs at an established railroad maintenance facility.
- Store creosote-treated railroad ties in railroad freight cars, in a building, or on an impervious surface covered by a tarpaulin.

**Figure 8.8: Installed Railroad Track Mats**



## Installed Railroad Track Mats

Revised June 2016

Please see <http://www.ecy.wa.gov/copyright.html> for copyright notice including permissions, limitation of liability, and disclaimer.

## **Recommended Operational and Structural Source Control BMPs**

At each rail/flange lubricator that is in service, use rain sensors to adjust the lubrication cycle accordingly to limit the amount of lubricant exposed to stormwater.

## **Applicable Runoff Treatment BMPs**

- In areas subjected to leaks/spills of oils or other chemicals, convey stormwater to appropriate treatment such as a sanitary sewer, if approved by the appropriate sewer authority, or to [BMP T5.100: API Separator Bay](#), [BMP T5.110: Coalescing Plate \(CP\) Separator Bay](#), or other runoff treatment BMP, as approved by the local jurisdiction.
- Store large metal scrap and materials that cannot be stored in covered areas because of their size, volume, and/or weight (for example rail and tie plates) in locations where stormwater runoff is managed, controlled, and directed to a runoff treatment BMP that meets the metals treatment performance goal.

## **S423E: BMPs for Recyclers and Scrap Yards**

### **Description of Pollutant Sources**

Includes businesses that reclaim various materials for resale or for scrap, such as vehicles and vehicle/equipment parts, construction materials, metals, beverage containers, and papers.

Potential sources of pollutants include paper, plastic, metal scrap debris, engines, transmissions, radiators, batteries, and other materials that are contaminated or that contain fluids. Other pollutant sources include leachate from metal components, contaminated soil, and the erosion of soil. Activities that can generate pollutants include the transfer, dismantling, and crushing of vehicles and scrap metal; the transfer and removal of fluids; maintenance and cleaning of vehicles, parts, and equipment; the storage of fluids, parts for resale, solid wastes, and scrap parts; and materials, equipment, and vehicles that contain fluids, generally in uncovered areas.

Potential pollutants typically found at vehicle recycle and scrap yards include oil and grease, ethylene and propylene glycol, polychlorinated biphenyls (PCBs), total suspended solids, biochemical oxygen demand, heavy metals, and acidic pH.

### **Applicable BMPs**

- For facilities subject to the Washington State Department of Ecology's Industrial Stormwater General Permit, see Ecology's automotive recyclers web page (<https://ecology.wa.gov/Regulations-Permits/Guidance-technical-assistance/Dangerous-waste-guidance/Common-dangerous-waste/Automotive-recyclers>) and *Vehicle and Metal Recyclers: A Guide for Implementing the Industrial Stormwater General National Pollutant Discharge Elimination System Permit Requirements* (Ecology, 2011). Apply the BMPs in that guidance document to scrap material recycling facilities depending on the pollutant sources at those facilities.
- Check incoming scrap materials, vehicles, and equipment for potential fluid contents and batteries.
- Drain and transfer fluids from vehicles and other equipment only in a designated area with a

waste collection system or over drip pans.

- Remove batteries and store on the ground in a leak proof container and under cover.
- Cover and raise any materials that may contaminate stormwater. A tarp and pallet are acceptable.
- Cover and contain stockpiles of any material that has the potential to contaminate stormwater runoff.
- All containers used to store fluids must comply with secondary containment requirements. Storage of gasoline must comply with the appropriate fire codes.

### **Required Routine Maintenance**

- Inspect storage areas regularly and promptly clean up any leaks, spills, or contamination.
- Sweep scrap storage areas as needed. Do not hose down anything to a storm drain.
- Keep spill cleanup materials in a location known to all. Ensure that employees are familiar with the site's spill control plan and/or proper spill cleanup procedures.
- If you are involved in transporting any of these materials, you must carry spill cleanup material in the vehicle to capture any spilled liquids and have an impermeable liner in the bed of your truck to capture any spilled or leaked materials. Properly dispose of or reuse any collected fluids.

### **Recommended BMPs**

Install catch basin inserts to collect excess sediment and debris if necessary. Inspect and maintain catch basin inserts to ensure they are working correctly.

## **S424E: BMPs for Roof/Building Drains at Manufacturing and Commercial Buildings**

### **Description of Pollutant Sources**

Stormwater runoff from roofs and sides of manufacturing and commercial buildings can be sources of pollutants caused by leaching of roofing materials, building vents, and other air emission sources. Research has identified vapors, entrained liquid, and solid droplets/particles as potential pollutants in roof/building runoff. Metals, solvents, acidic/alkaline pH, biochemical oxygen demand, and organics are some of the pollutant constituents identified.

The Washington State Department of Ecology has performed a study on zinc in industrial stormwater. The study results are presented in *Suggested Practices to Reduce Zinc Concentrations in Industrial Stormwater Discharges* ([Ecology, 2008](#)). See ([Ecology, 2008](#)) for more details on addressing zinc in stormwater.

### **Pollutant Control Approach**

Evaluate the potential sources of stormwater pollutants and apply source control BMPs where feasible.

## ***Applicable Operational Source Control BMPs***

- If leachates and/or emissions from buildings are suspected sources of stormwater pollutants, sample and analyze the stormwater draining from the building.
- Sweep the area routinely to remove any zinc residuals.
- If a roof/building stormwater pollutant source is identified, implement appropriate source control measures such as air pollution control equipment, selection of materials, operational changes, material recycle, process changes, etc.

## ***Applicable Structural Source Control BMPs***

Paint/coat the galvanized surfaces as described in *Suggested Practices to Reduce Zinc Concentrations in Industrial Stormwater Discharges* ([Ecology, 2008](#)).

## ***Applicable Runoff Treatment BMPs***

Treat runoff from roofs to the appropriate level. The facility may use metals treatment BMPs as described in [Chapter 5 - Runoff Treatment BMP Design](#). Some facilities regulated by the Industrial Stormwater General Permit, or local jurisdiction, may have requirements that cannot be achieved with metals treatment BMPs. In these cases, additional treatment measures may be required. A treatment method for meeting stringent requirements such as chitosan-enhanced sand filtration may be appropriate.

## **S425E: BMPs for Soil Erosion and Sediment Control at Industrial Sites**

### ***Description of Pollutant Sources***

Industrial activities on soil areas, exposed and disturbed soils, steep grading, etc., can be sources of sediments that can contaminate stormwater runoff.

### ***Pollutant Control Approach***

Limit the exposure of erodible soil, stabilize or cover erodible soil where necessary to prevent erosion, and/or provide treatment for stormwater contaminated with total suspended solids caused by eroded soil.

### ***Applicable BMPs***

- Limit the exposure of erodible soil.
- Stabilize entrances/exits to prevent track-out. See [BMP C105E: Stabilized Construction Access](#).
- Stabilize or cover erodible soil to prevent erosion. Cover practice options include the following:
  - Use of vegetative cover such as grass, trees, or shrubs on erodible soil areas.
  - Coverage with mats such as clear plastic, jute, or synthetic fiber. See [BMP C122E: Nets and Blankets](#) and [BMP C123E: Plastic Covering](#).

- Preservation of natural vegetation including grass, trees, shrubs, and vines when possible. See [BMP C101E: Preserving Natural Vegetation](#).
- If stabilizing or covering the erodible soil is not possible, then structural controls must be implemented. Structural practice options include the following:
  - Vegetated swale
  - [BMP C200E: Interceptor Dike and Swale](#)
  - [BMP C233E: Silt Fence](#)
  - [BMP C207E: Check Dams](#)
  - [BMP C232E: Gravel Filter Berm](#)
  - Sedimentation basin
  - Proper grading
  - Paving

**For more information:** For design information, see [Chapter 7 - Construction Stormwater Pollution Prevention](#).

## **S426E: BMPs for Spills of Oil and Hazardous Substances**

### ***Description of Pollutant Sources***

Federal law requires owners or operators of facilities engaged in drilling, producing, gathering, storing, processing, transferring, distributing, refining, or consuming oil and/or oil products to have a spill prevention control and countermeasures (SPCC) plan. The SPCC plan is required if the facility has:

- Aboveground storage of a single container > 660 gallons,
- An aggregate capacity > 1,320 gallons, or
- A total belowground capacity > 42,000 gallons.

Additionally, the SPCC plan is required if the facility due to its location could reasonably be expected to discharge oil in harmful quantities, as defined in [40 CFR Part 110](#), into or on the navigable waters of the United States or adjoining shorelines ([40 CFR 112.1 \[b\]](#)). Onshore and offshore facilities that due to their location could not reasonably be expected to discharge oil into or on the navigable waters of the United States or adjoining shorelines are exempt from these regulations ([40 CFR 112.1\[1\]\[i\]](#)). State law requires owners of businesses that produce dangerous wastes to have a SPCC plan. These businesses should refer to [Chapter 90.56 RCW](#), [Chapter 173-182 WAC](#), and [WAC 173-303-350](#) for specific contingency planning and emergency procedures.

### ***Pollutant Control Approach***

Maintain, update, and implement a SPCC plan.

## ***Applicable Operational BMPs***

The businesses and public agencies identified in [Appendix 8-A: Urban Land Uses and Pollution-Generating Sources](#) that are required to prepare and implement a SPCC plan shall implement the following:

- Prepare a SPCC plan, which includes the following:
  - A description of the facility including the owner's name and address.
  - The nature of the activity at the facility.
  - The general types of chemicals used or stored at the facility.
  - A site plan showing the location of storage areas for chemicals, the locations of storm drains, the areas draining to them, and the location and description of any devices to stop spills from leaving the site such as positive control valves.
  - Cleanup procedures.
  - Notification procedures to be used in the event of a spill, such as notifying key personnel. Agencies such as the Washington State Department of Ecology (Ecology), the local fire department, the Washington State Patrol, the local jurisdiction, and the local sewer authority, shall be notified.
  - The name of the designated person with overall spill cleanup and notification responsibility.
- Train key personnel in the implementation of the SPCC plan. Prepare a summary of the plan and post it at appropriate points in the building, identifying the spill cleanup coordinators, location of spill kits, and phone numbers of regulatory agencies to be contacted in the event of a spill.
- Update the SPCC plan regularly.
- Immediately notify Ecology, the local jurisdiction, and the local sewer authority if a spill may reach sanitary or storm drains, ground water, or surface water, in accordance with federal and Ecology spill reporting requirements;
- Immediately clean up spills. Do not use emulsifiers for cleanup unless there is an appropriate disposal method for the resulting oily wastewater. Do not wash absorbent material down a floor drain or storm drain.
- Locate emergency spill containment and cleanup kit(s) in high-potential spill areas. The contents of the kit shall be appropriate for the type and quantities of chemical liquids stored at the facility.

## ***Recommended Operational BMP***

Spill kits should include appropriately lined drums, absorbent pads, and granular or powdered materials for neutralizing acids or alkaline liquids, where applicable. In fueling areas, package absorbent material in small bags for easy use and make available small drums for storage of



absorbent and/or used absorbent. Deploy spill kits in a manner that allows rapid access and use by employees.

## **S427E: BMPs for Storage of Liquid, Food Waste, or Dangerous Waste Containers**

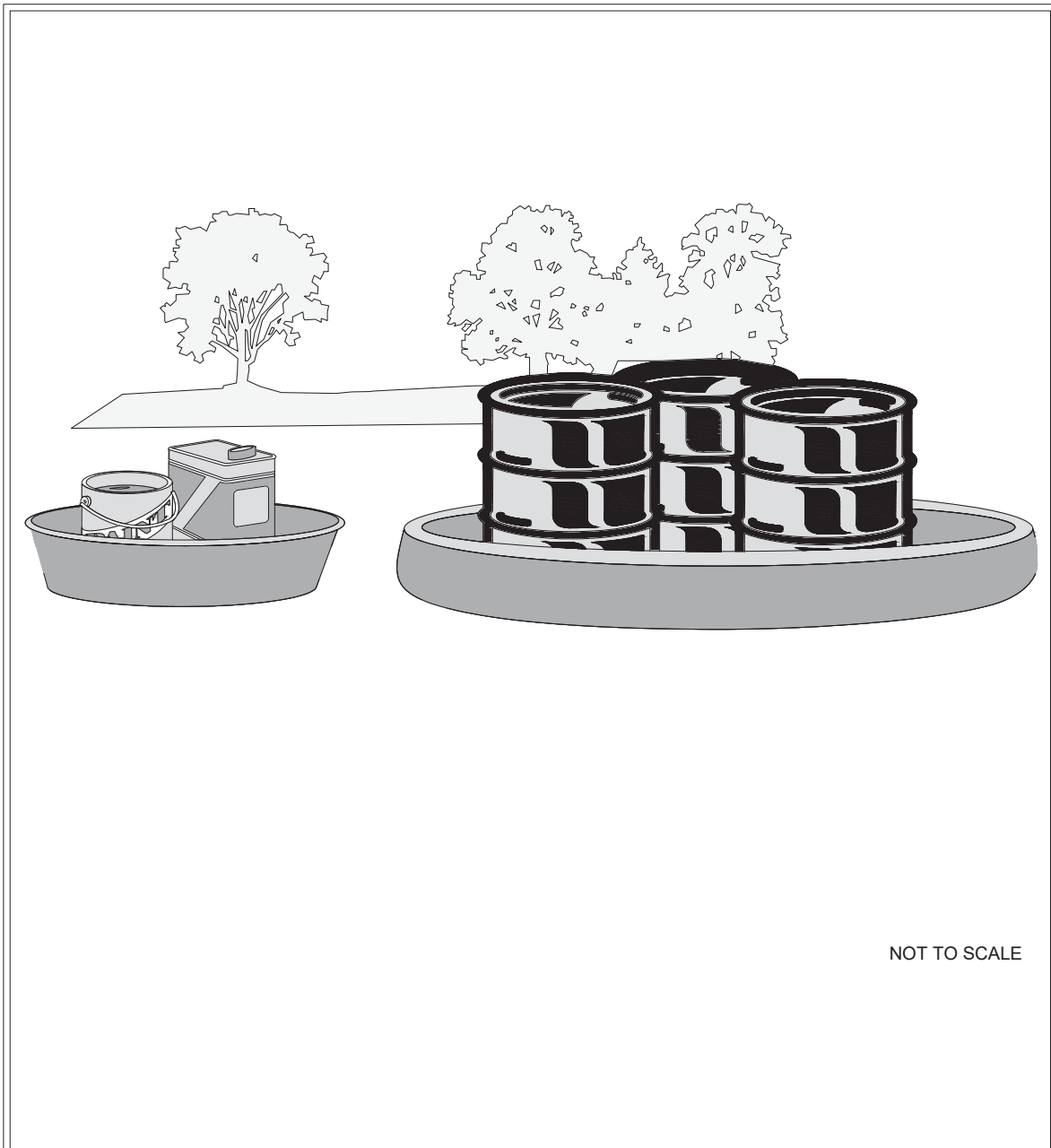
### ***Description of Pollutant Sources***

Steel and plastic drums with volumetric capacities of  $\leq 55$  gallons are typically used at industrial facilities for container storage of liquids and powders. The BMPs specified in this section apply to container(s) located outside a building. Use these BMPs when temporarily storing accumulated food wastes, vegetable or animal grease, used oil, liquid feedstock, cleaning chemicals, or dangerous wastes (liquid or solid). These BMPs do not apply when the Washington State Department of Ecology (Ecology) has permitted the business to store the wastes. Standards for solids waste containers are identified in the On-Site Storage, Collection, and Transportation Standards ([WAC 173-350-300](#)). Leaks and spills of pollutant materials during handling and storage are the primary sources of pollutants. Oil and grease, acid/alkali pH, biochemical oxygen demand, and chemical oxygen demand are potential pollutant constituents.

### ***Pollutant Control Approach***

Store containers in impervious containment under a roof or other appropriate cover or in a building. When collection trucks directly pick up roll-containers, ensure that a filet is placed on both sides of the curb to facilitate movement of the dumpster. For on-site storage areas to be used  $< 30$  days, consider using a portable temporary secondary system like that shown in [Figure 8.9: Secondary Containment System](#) in lieu of a permanent system.

**Figure 8.9: Secondary Containment System**



NOT TO SCALE



## Secondary Containment System

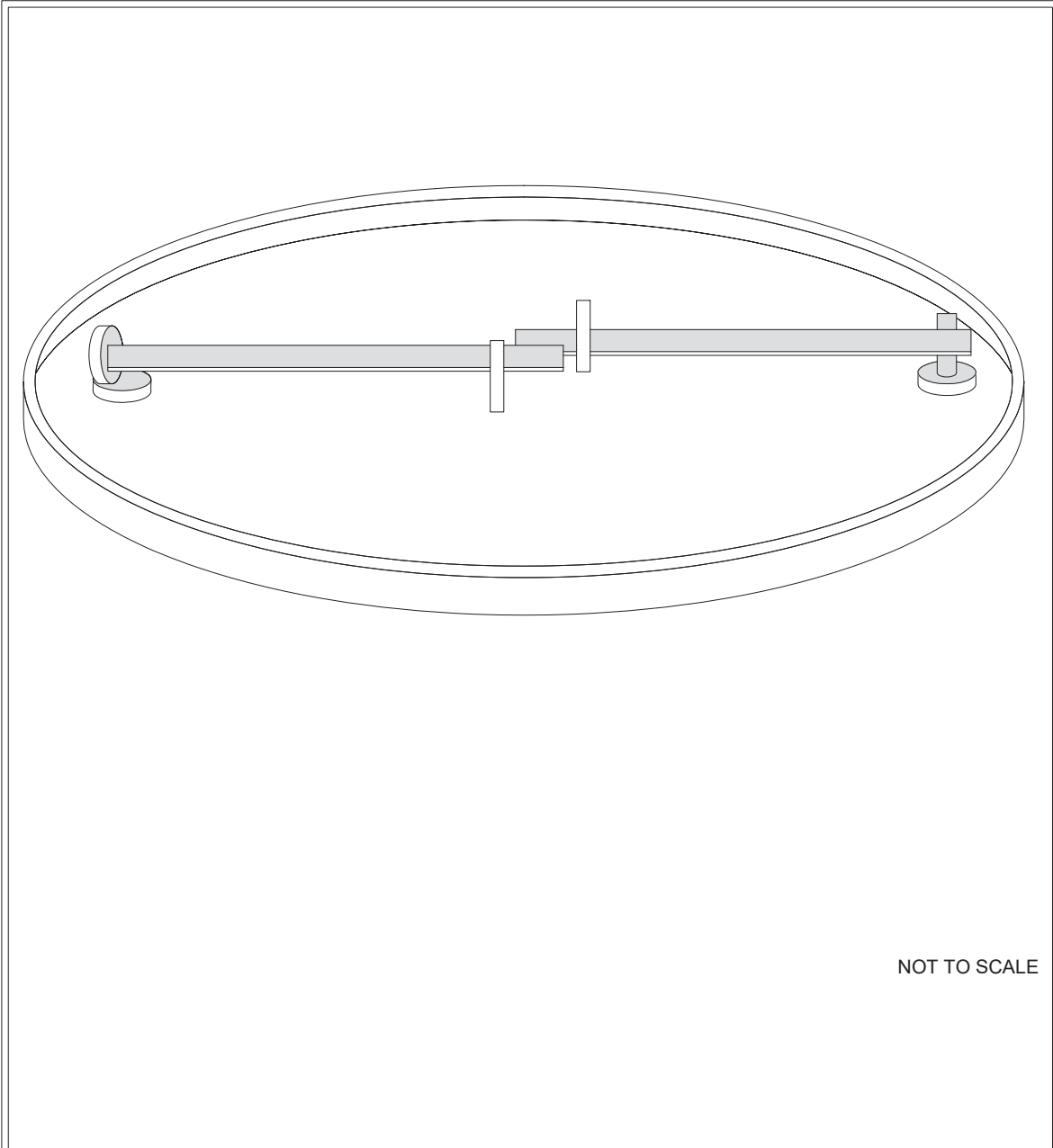
Revised June 2016

Please see <http://www.ecy.wa.gov/copyright.html> for copyright notice including permissions, limitation of liability, and disclaimer.

## ***Applicable Operational BMPs***

- Place tight-fitting lids on all containers.
- Label all containers with their contents, accumulation start date, and owner information.
- Place drip pans beneath all mounted container taps and at all potential drip and spill locations during filling and unloading of containers.
- Inspect container storage areas regularly for corrosion, structural failure, spills, leaks, overfills, and failure of piping systems. Check containers daily for leaks/spills. Replace containers, and replace and tighten bungs in drums, as needed.
- Businesses accumulating dangerous wastes that do not contain free liquids need only to store these wastes in a sloped designated area with the containers elevated or otherwise protected from stormwater run-on. Secure drums when stored in an area where unauthorized persons may gain access in a manner that prevents accidental spillage, pilferage, or any unauthorized use (see [Figure 8.10: Locking System for Drum Lid](#)).

**Figure 8.10: Locking System for Drum Lid**



NOT TO SCALE



## Locking System for Drum Lid

Revised June 2016

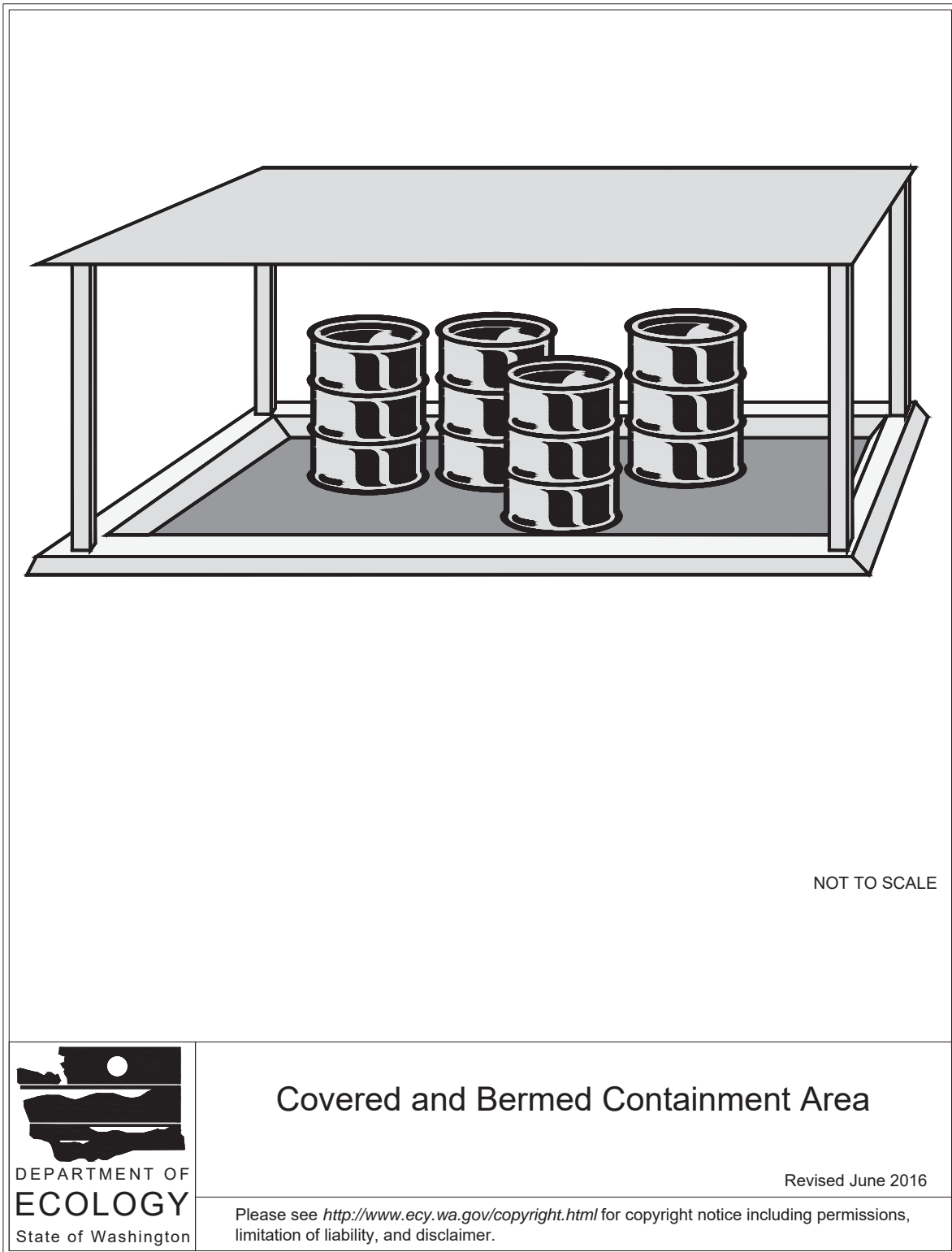
Please see <http://www.ecy.wa.gov/copyright.html> for copyright notice including permissions, limitation of liability, and disclaimer.

- If the material is a dangerous waste, the business owner must comply with the Dangerous Waste Regulations ([Chapter 173-303 WAC](#)) and Ecology's *Step by Step Fact Sheet for Hazardous Waste Generators* ([Ecology, 2003](#)).
- Storage of flammable, ignitable, and reactive chemicals and materials must comply with the stricter of the local zoning codes, local fire codes, Uniform Fire Code (UFC), UFC standards, or the National Electric Code.
- Provide spill kits or cleanup materials near container storage areas.
- Clean up all spills immediately.
- Cover dumpsters, or keep them under cover, such as a lean-to, to prevent the entry of stormwater. Replace or repair leaking garbage dumpsters.
- Drain dumpsters and/or dumpster pads to sanitary sewer. Keep dumpster lids closed. Install waterproof liners.

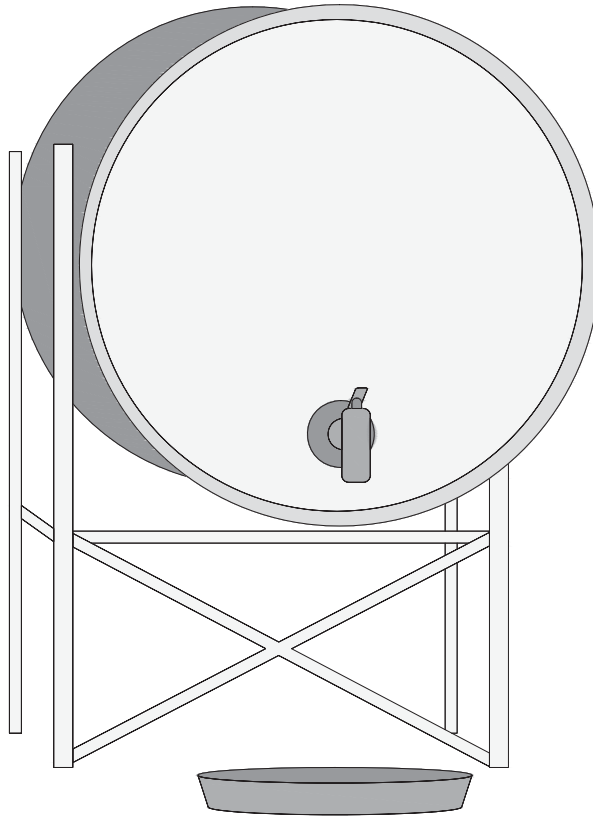
### ***Applicable Structural Source Control BMPs***

- Keep containers with dangerous waste, food waste, or other potential pollutant liquids inside a building, unless this is not feasible due to site constraints or UFC/International Fire Code requirements.
- Store containers in a designated area that is covered, bermed or diked, paved, and impervious, in order to contain leaks and spills (see [Figure 8.11: Covered and Bermed Containment Area](#)). Slope the secondary containment to drain into a dead-end sump for the collection of leaks and small spills.
- For liquid wastes, surround the containers with a dike as illustrated in [Figure 8.11: Covered and Bermed Containment Area](#). The dike must be of sufficient height to provide a volume of either 10% of the total enclosed container volume or 110% of the volume contained in the largest container, whichever is greater.
- Where material is temporarily stored in drums, use a containment system as illustrated (see [Figure 8.9: Secondary Containment System](#)), in lieu of the above system.
- Place containers mounted for direct removal of a liquid chemical for use by employees inside a containment area as described above. Use a drip pan during liquid transfer (see [Figure 8.12: Mounted Container – with Drip Pan](#)).

**Figure 8.11: Covered and Bermed Containment Area**



**Figure 8.12: Mounted Container – with Drip Pan**



\*Note that the secondary containment is not shown in this figure

NOT TO SCALE



## Mounted Container - with Drip Pan

Revised June 2016

Please see <http://www.ecy.wa.gov/copyright.html> for copyright notice including permissions, limitation of liability, and disclaimer.

## ***Applicable Runoff Treatment BMP***

**Note:** This treatment BMP applies to contaminated stormwater from drum storage areas.

- For contaminated stormwater in the containment area, connect the sump outlet to a sanitary sewer, if approved by the local sewer authority, or to appropriate treatment, such as an American Petroleum Institute or coalescing plate oil and water separator or other appropriate system (see [Chapter 5 - Runoff Treatment BMP Design](#)). Equip the sump outlet with a normally closed valve to prevent the release of spilled or leaked liquids, especially flammables (compliance with fire codes), and dangerous liquids. Open this valve only for the conveyance of contaminated stormwater to treatment.
- Another option for discharge of contaminated stormwater is to pump it from a dead-end sump or catchment to a tank truck or other appropriate vehicle for off-site treatment and/or disposal.

## **S428E: BMPs for Storage of Liquids in Permanent Aboveground Tanks**

### ***Description of Pollutant Sources***

Aboveground tanks containing liquids (excluding uncontaminated water) may be equipped with a valved drain, vent, pump, and bottom hose connection. Aboveground tanks may be heated with steam heat exchangers equipped with steam traps, if required. Leaks and spills can occur at connections and during liquid transfer. Oil and grease, organics, acids, alkalis, and heavy metals in tank water and condensate drainage can also cause stormwater contamination at storage tanks.

### ***Pollutant Control Approach***

Install secondary containment or a double-walled tank. Slope the containment area to a drain with a sump. Operators may need to discharge stormwater collected in the containment area to treatment such as an American Petroleum Institute (API) or coalescing plate (CP) oil and water separator, or equivalent BMP. Add safeguards against accidental releases, including protective guards around tanks to protect against vehicle or forklift damage, and tagging valves to reduce human error. Tank water and condensate discharges are process wastewater that may need a National Pollutant Discharge Elimination System Stormwater General Permit.

### ***Applicable Operational BMPs***

- Inspect the tank containment areas regularly for leaks/spills, cracks, corrosion, etc., to identify problem components, such as fittings, pipe connections, and valves.
- Place adequately sized drip pans beneath all mounted taps and drip/spill locations during filling/unloading of tanks. Operators may need valved drain tubing in mounted drip pans.
- Vacuum sweep and clean the tank storage area regularly, if paved.
- Replace or repair tanks that are leaking, corroded, or otherwise deteriorating.
- Storage of flammable, ignitable, and reactive chemicals and materials must comply with the stricter of local zoning codes, local fire codes, the Uniform Fire Code (UFC), UFC standards, or the National Electric Code.



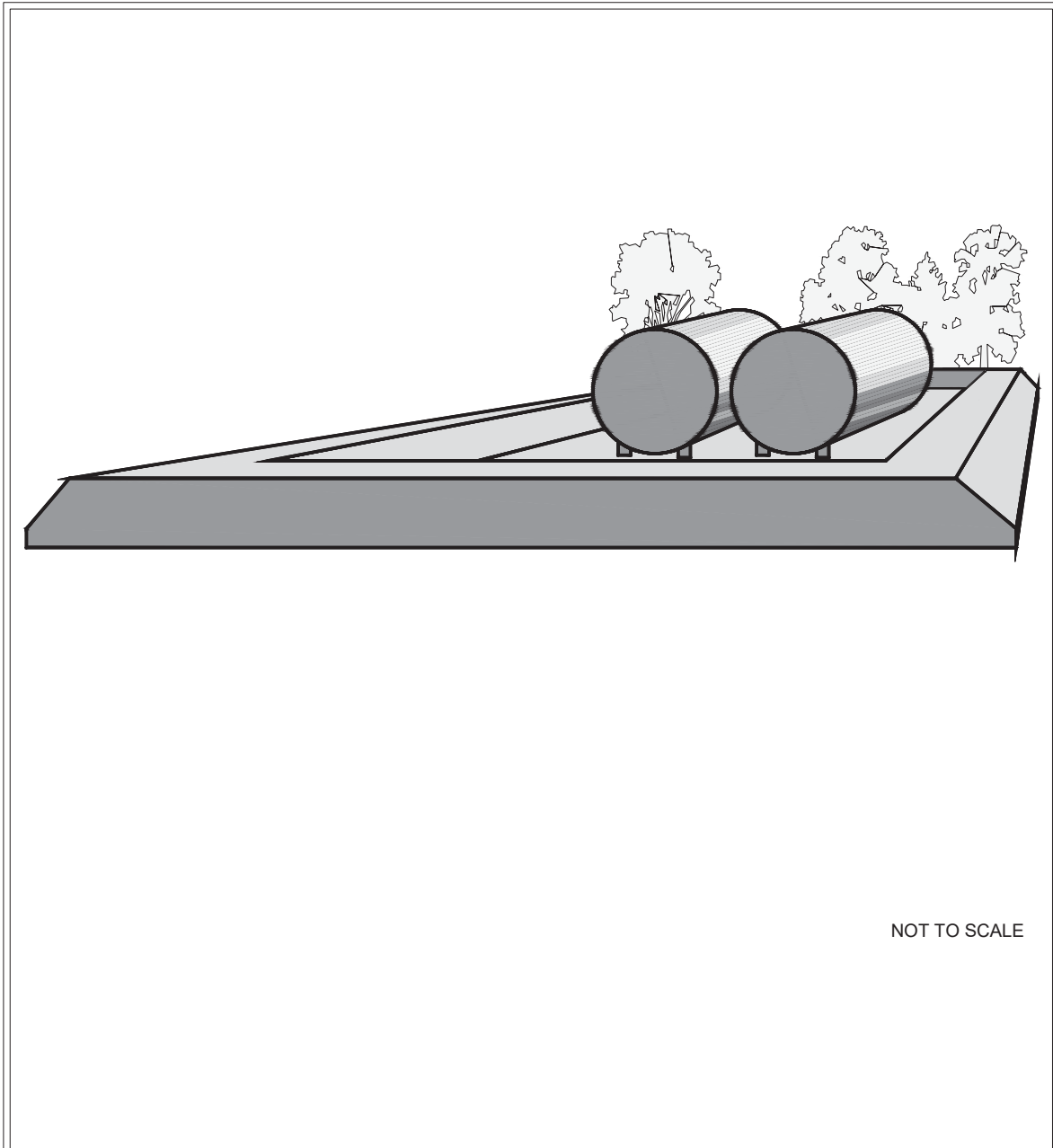
## ***Applicable Structural Source Control BMPs***

- Locate permanent tanks in impervious (Portland cement concrete or equivalent) secondary containment surrounded by dikes as illustrated in [Figure 8.13: Above-Ground Tank Storage](#) or use UL-approved double-walled tanks. The dike must be of sufficient height to provide a containment volume of either 10% of the total enclosed tank volume or 110% of the volume contained in the largest tank, whichever is greater.
- Slope the secondary containment to drain to a dead-end sump (optional), or equivalent, for the collection of small spills.
- Include a tank overflow protection system to minimize the risk of spillage during loading.

## ***Applicable Runoff Treatment BMPs***

- Depending on the kind of liquid being stored, the potential and type of stormwater contamination will vary and may require specialized treatment.
- For an uncovered tank containment area is uncovered, equip the outlet from the spill-containment sump with a normally closed shutoff valve. Operators may open this valve manually or automatically, only to convey contaminated stormwater to approved treatment or disposal, or to convey uncontaminated stormwater to a storm drain. Evidence of contamination can include the presence of visible sheen, color, or turbidity in the runoff, or existing or historical operational problems at the facility. Use simple pH tests with litmus or pH paper can be used for areas subject to acid or alkaline contamination.
- At petroleum tank farms, convey stormwater contaminated with floating oil or debris in the contained area through an API or CP oil and water separator ([Chapter 5 - Runoff Treatment BMP Design](#)), or other approved treatment prior to discharge to storm drain or surface water.

**Figure 8.13: Above-Ground Tank Storage**



NOT TO SCALE



## Above-Ground Tank Storage

Revised June 2016

Please see <http://www.ecy.wa.gov/copyright.html> for copyright notice including permissions, limitation of liability, and disclaimer.

## **S429E: BMPs for Storage or Transfer (Outside) of Solid Raw Materials, By-Products, or Finished Products**

### ***Description of Pollutant Sources***

Some pollutant sources stored outside in large piles, stacks, etc. at commercial or industrial establishments include the following:

- Solid raw materials
- Byproducts
- Gravel
- Sand
- Salts
- Topsoil
- Compost
- Logs
- Sawdust
- Wood chips
- Lumber
- Concrete
- Metal products

Contact between outside bulk materials and stormwater can cause leachate and/or erosion of the stored materials. Contaminants may include total suspended solids (TSS), biochemical oxygen demand, organics, and dissolved salts (sodium, calcium, and magnesium chloride, etc.).

### ***Pollutant Control Approach***

Provide impervious containment with berms, dikes, etc., and/or cover to prevent run-on and discharge of leachate pollutant(s) and TSS.

### ***Applicable Operational BMP***

Do not hose down the contained stockpile area to a storm drain, to a conveyance to a storm drain, or to a receiving water.

### ***Recommended Operational BMPs***

- Maintain contributing areas in and around storage of solid materials with a minimum slope of 1.5% to prevent pooling and minimize leachate formation. Areas should be sloped to drain stormwater to the perimeter for collection or to internal drainage “alleyways” where no

stockpiled material exists.

- Sweep paved storage areas regularly for collection and disposal of loose solid materials.
- If and when feasible, collect and recycle water-soluble materials (leachates).
- Stock cleanup materials, such as brooms, dustpans, and vacuum sweepers near the storage area.

### ***Applicable Structural Source Control BMPs***

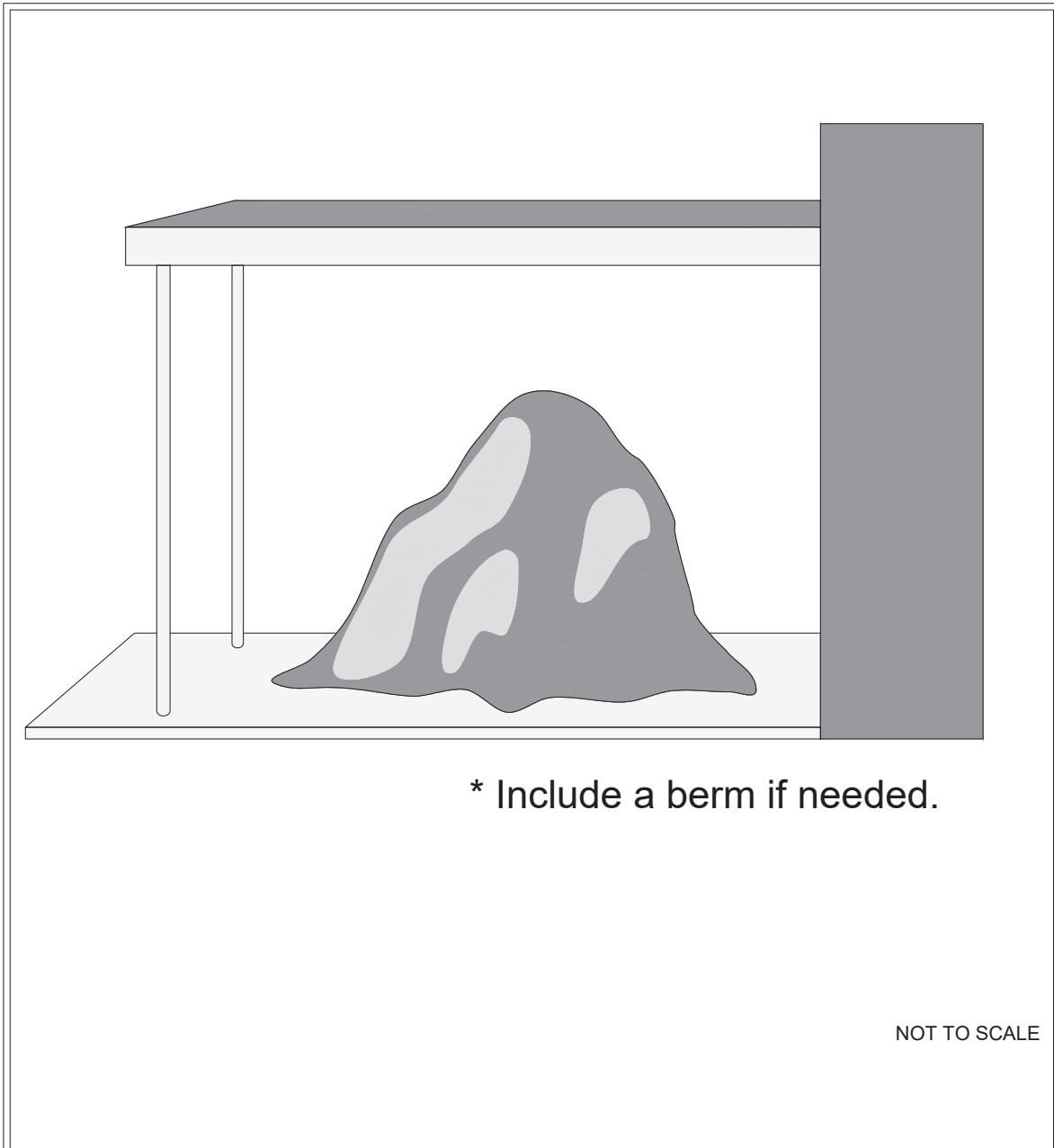
The source control BMP options listed in this section are applicable to the following:

- Stockpiles containing > 5 cubic yards of erodible or water-soluble materials such as:
  - Soil,
  - Road deicing salts,
  - Compost,
  - Unwashed sand and gravel, and
  - Sawdust.
- Outside storage areas for solid materials such as:
  - Logs,
  - Bark,
  - Lumber, and
  - Metal products.

Choose one or more of the following source control BMPs:

- Store in a building or a paved, bermed, and covered area as shown in [Figure 8.14: Covered Storage Area for Bulk Solids \(include berm if needed\)](#).
- Place temporary plastic sheeting (polyethylene, polypropylene, Hypalon, or equivalent) over the material as illustrated (see [Figure 8.15: Material Covered with Plastic Sheetting](#)).
- Pave the area and install a drainage system. Place curbs or berms along the perimeter of the area to prevent the run-on of uncontaminated stormwater and to collect and convey runoff to treatment. Slope the paved area in a manner that minimizes the contact between stormwater (e.g., pooling) and leachable materials in compost, logs, bark, wood chips, etc.
- For large uncovered stockpiles, implement containment practices at the perimeter of the site and at any catch basins as needed to prevent erosion and discharge of the stockpiled material off-site or to a storm drain. Ensure that no direct discharge of contaminated stormwater to catch basins exists to catch basins without conveying runoff through an appropriate runoff treatment BMP.

**Figure 8.14: Covered Storage Area for Bulk Solids (include berm if needed)**



\* Include a berm if needed.

NOT TO SCALE

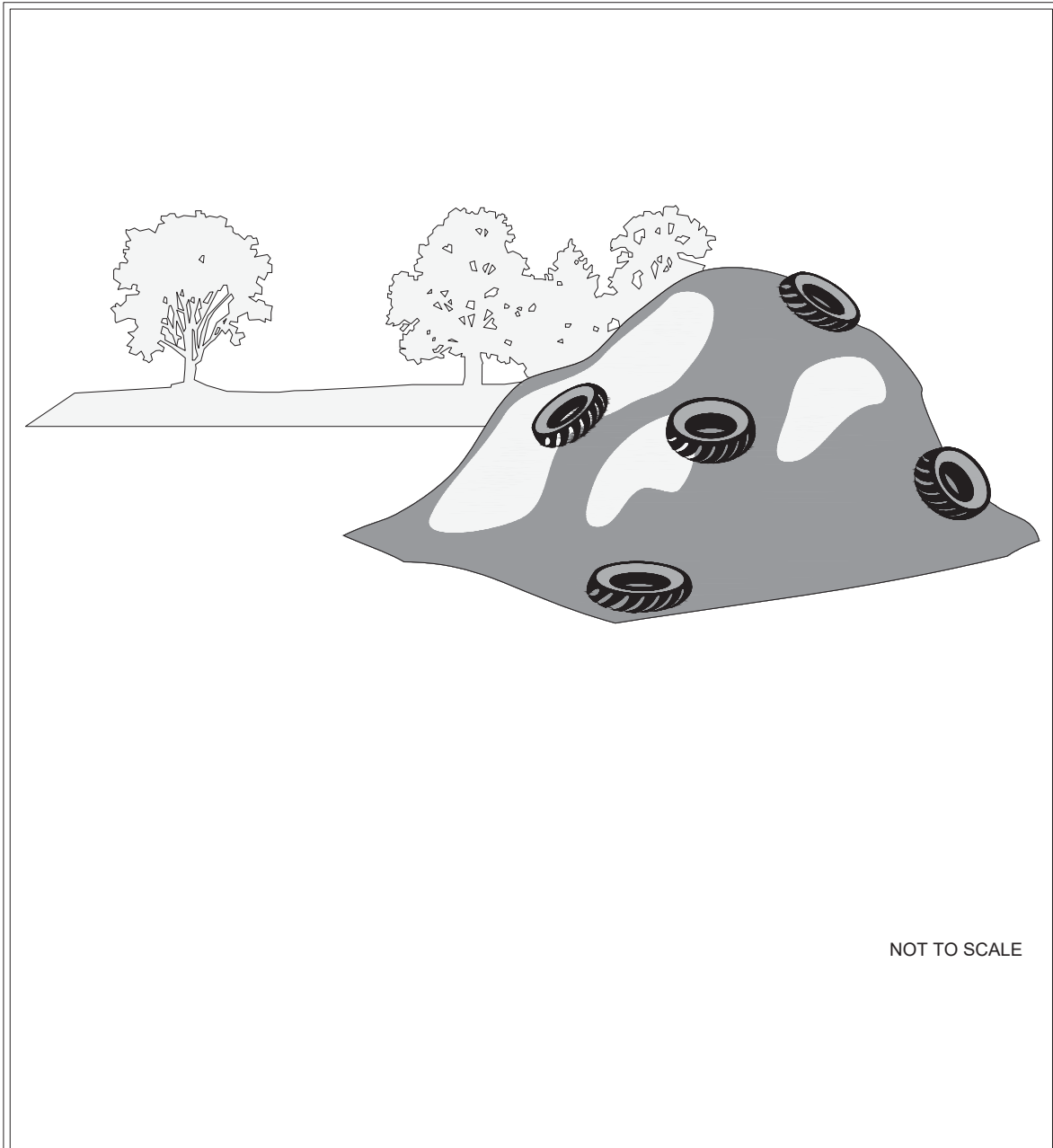


**Covered Storage Area for Bulk Solids  
(include berm if needed)**

Revised June 2016

Please see <http://www.ecy.wa.gov/copyright.html> for copyright notice including permissions, limitation of liability, and disclaimer.

**Figure 8.15: Material Covered with Plastic Sheeting**



## Material Covered with Plastic Sheeting

Revised June 2016

Please see <http://www.ecy.wa.gov/copyright.html> for copyright notice including permissions, limitation of liability, and disclaimer.

## ***Applicable Runoff Treatment BMP***

Convey contaminated stormwater from the stockpile area to the following:

- [BMP T5.70: Basic Wetpond](#)
- [BMP T5.71: Large Wetpond](#)
- [BMP T5.72: Wetvaults](#)
- Settling basin
- Other appropriate runoff treatment BMP depending on the contamination

## **S430E: BMPs for Urban Streets**

### ***Description of Pollutant Sources***

Urban streets can be the source of vegetative debris, paper, fine dust, vehicle liquids, tire and break wear residues, heavy metals (lead and zinc), soil particles, ice control salts, domestic wastes, lawn chemicals, and vehicle combustion products. Street surface contaminants contain significant concentrations of particle sizes < 250 microns ([Sartor and Boyd, 1972](#)).

### ***Pollutant Control Approach***

Conduct efficient street sweeping where and when appropriate to minimize the contamination of stormwater. Do not wash street debris into storm drains.

Facilities not covered under the Industrial Stormwater General Permit may consider a minimum amount of water washing of streets. All facilities must comply with their local stormwater requirements for discharging to storm drains. Municipal Stormwater permittees are required to limit street washwater discharges and may have special conditions or treatment requirements.

### ***Recommended BMPs***

- For maximum stormwater pollutant reductions on curbed streets and high-volume parking lots use efficient vacuum sweepers.

**Note:** High-efficiency street sweepers use strong vacuums and the mechanical action of main and gutter brooms combined with an air filtration system that only returns clean air to the atmosphere (i.e., filters very fine particulates). They sweep dry and use no water, because they do not emit any dust.

High-efficiency vacuum sweepers have the capability of removing 80% or more of the accumulated street dirt particles whose diameters are < 250 microns, from pavements under good condition ([Sutherland et al., 1998](#)). This assumes pavements under good condition and reasonably expected accumulation conditions.

- For moderate stormwater pollutant reductions on curbed streets use regenerative air sweepers or tandem sweeping operations.

**Note:** A tandem sweeping operation involves a single pass of a mechanical sweeper followed immediately by a single pass of a vacuum sweeper or regenerative air sweeper.

- A regenerative air sweeper blows air down on the pavement to entrain particles and uses a return vacuum to transport the material to the hopper.
- These operations usually use water to control dust. This reduces their ability to pick up fine particulates.

These types of sweepers have the capability of removing approximately 25% to 50% of the accumulated street dirt particles whose diameters are < 250 microns ([Sutherland et al., 1998](#)). This assumes pavements under good condition and typical accumulation conditions.

- For minimal stormwater pollutant reductions on curbed streets use mechanical sweepers.

**Note:** The industry refers to mechanical sweepers as broom sweepers and uses the mechanical action of main and gutter brooms to throw material on a conveyor belt that transports it to the hopper.

These sweepers usually use water to control dust. This reduces their ability to pick up fine particulates.

It has been reported that mechanical sweepers have the capability of removing only 10% to 20% of the accumulated street dirt particles whose diameters are < 250 microns ([Sutherland et al., 1998](#)). This assumes the most favorable accumulation conditions and pavement in good condition.

- Conduct vacuum sweeping at optimal frequencies. Optimal frequencies are those scheduled sweeping intervals that produce the most cost-effective annual reduction of pollutants normally found in stormwater and can vary depending on land use, traffic volume, and rainfall patterns.
- Train operators in those factors that result in optimal pollutant removal. These factors include sweeper speed, brush adjustment and rotation rate, sweeping pattern, maneuvering around parked vehicles, and interim storage and disposal methods.
- Consider the use of periodic parking restrictions in low- to medium-density single-family residential areas to ensure the sweeper's ability to sweep along the curb.
- Establish programs for prompt vacuum sweeping, removal, and disposal of debris from special events that will generate higher than normal loadings.
- Disposal of street sweeping solids must comply with [Appendix 8-B: Management of Street Waste Solids and Liquids](#).
- Consider developing ordinances that prohibit citizens from putting yard debris in the street gutters or doing vehicle maintenance on the street.
- Provide incentives to property owners for installing permeable pavement parking areas and driveways.
- Consider installing catch basin inserts in high use areas to remove trash and yard debris before it enters the system.



- Implement a storm drain stenciling program to label and educate the public not to dump materials into storm drains or onto sidewalks, streets, parking lots, and gutters.
- Provide household hazardous waste collection and used oil recycling for citizens to avoid illegal dumping.

## **S431E: BMPs for Washing and Steam Cleaning Vehicles/ Equipment/Building Structures**

### ***Description of Pollutant Sources***

Pollutant sources include the commercial cleaning of vehicles, aircraft, vessels, and other transportation, restaurant kitchens, carpets, and industrial equipment, and large buildings with low- or high- pressure water or steam. This includes “charity” car washes at gas stations and commercial parking lots. The cleaning can include hand washing, scrubbing, sanding, etc. Washwater from cleaning activities can contain oil and grease, suspended solids, heavy metals, soluble organics, soaps, and detergents that can contaminate stormwater.

### ***Permitting Requirements***

Obtain all necessary permits for installing, altering, or repairing onsite drainage and side sewers. Restrictions on certain types of discharges may require pretreatment before they enter the sanitary sewer.

### ***Pollutant Control Approach***

The preferred approach is to cover and/or contain the cleaning activity, or conduct the activity inside a building, to separate the uncontaminated stormwater from the washwater sources. Convey washwater to a sanitary sewer after approval by the local sewer authority. Provide temporary storage before proper disposal, or recycling. Under this preferred approach, no discharge to the ground, to a storm drain, or to surface water should occur.

The Industrial Stormwater General Permit (ISGP) prohibits the discharge of process wastewater (e.g., vehicle washing wastewater) to ground water or surface water. Stormwater that commingles with process wastewater is considered process wastewater.

Facilities not covered under the ISGP that are unable to follow one of the preferred approaches listed above may discharge washwater to the ground only after proper treatment in accordance with *Vehicle and Equipment Washwater Discharges/Best Management Practices Manual* ([Ecology, 2012](#)).

The quality of any discharge to the ground after proper treatment must comply with the Washington State Department of Ecology (Ecology) Water Quality Standards for Ground, [Chapter 173-200 WAC](#).

Facilities not covered under the ISGP that are unable to comply with one of the preferred approaches and want to discharge to storm drain, must meet their local stormwater requirements. Local jurisdictions may require treatment prior to discharge.

Contact the local Ecology regional office (<https://ecology.wa.gov/About-us/Get-to-know-us/Contact-us>) to discuss permitting options for a National Pollutant Discharge Elimination System (NPDES)

Stormwater General Permit application for discharge of washwater to a receiving water or to a storm drain after on-site treatment.

### **Applicable Structural Source Control BMPs**

Conduct vehicle/equipment washing in one of the following locations:

- At a commercial washing facility in which the washing occurs in an enclosure and drains to the sanitary sewer
- In a building constructed specifically for washing of vehicles and equipment, which drains to a sanitary sewer

Conduct outside washing operation in a designated wash area with the following features:

- In a paved area, construct a spill containment pad to prevent the run-on of stormwater from adjacent areas. Slope the spill containment area to collect washwater in a containment pad drain system with perimeter drains, trench drains, or catchment drains. Size the containment pad to extend out a minimum of 4 feet on all sides of the washed vehicles and/or equipment.
- Convey the washwater to a sump (like a grit separator) and then to a sanitary sewer (if allowed by the local sewer authority), or other appropriate wastewater treatment or recycle system. The containment sump must have a positive control outlet valve for spill control with live containment volume and oil and water separation. Size the minimum live storage volume to contain the maximum expected daily washwater flow plus the sludge storage volume below the outlet pipe. Shut the outlet valve during the washing cycle to collect the washwater in the sump. The valve should remain shut for  $\geq 2$  hours following the washing operation to allow the oil and solids to separate before discharge to a sanitary sewer.
- Close the inlet valve in the discharge pipe when washing is not occurring, thereby preventing the entry of uncontaminated stormwater into the pretreatment/treatment system. The stormwater can then drain into the conveyance/discharge system outside of the wash pad (essentially bypassing the sanitary sewer or recycle system). Post signs to inform people of the operation and purpose of the valve. Clean the concrete pad thoroughly until there is no foam or visible sheen in the washwater prior to closing the inlet valve and allowing uncontaminated stormwater to overflow and drain off the pad (see [Figure 8.16: Uncovered Wash Area](#)).

**Note:** The purpose of the valve is to convey only washwater and contaminated stormwater to a treatment system.

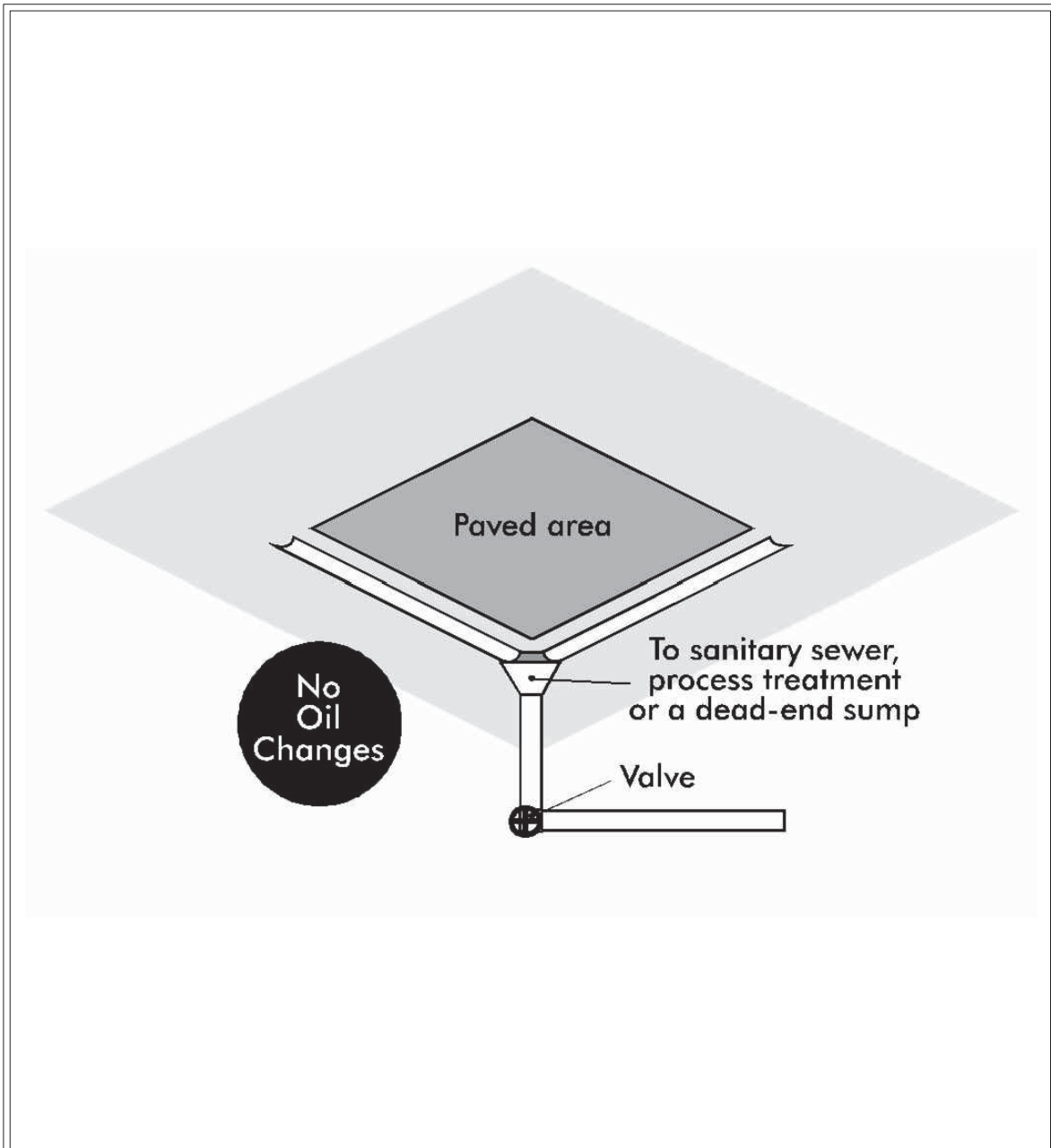
- Collect the washwater from building structures and convey it to appropriate treatment, such as a sanitary sewer system if it contains oils, soaps, or detergents. If the washwater does not contain oils, soaps, or detergents (in this case only a low-pressure, clean, cold water rinse is allowed) then it could drain to soils that have sufficient natural attenuation capacity for dust and sediment.
- Sweep surfaces prior to cleaning/washing to remove excess sediment and other pollutants.
- If roof equipment or hood vents are cleaned, ensure that no washwater or process water is discharged to the roof drains or drainage systems.

- Label all mobile cleaning equipment as follows: “Properly dispose of all wastewater. Do not discharge to an inlet/catch basin, ditch, stream, or on the ground.”

### ***Recommended BMPs***

- Mark the wash area at gas stations, multifamily residences, and any other business where non-employees wash vehicles.
- Operators may use a manually operated positive control valve for uncovered wash pads, but a pneumatic or electric valve system is preferable. The valve may be on a timer circuit and opened upon completion of a wash cycle. After draining the sump or separator, the timer would then close the valve.
- Minimize the use of water and detergents in washing operations when practicable.
- Use phosphate-free biodegradable detergents when practicable.
- Use the least hazardous cleaning products available.
- Consider recycling the washwater.
- Operators may use soluble/emulsifiable detergents in the wash medium and should use with care and the appropriate treatment. Carefully consider the selection of soaps and detergents and runoff treatment BMPs. Oil and water separators are ineffective in removing emulsified or water-soluble detergents. Another treatment appropriate for emulsified and water-soluble detergents may be required.

**Figure 8.16: Uncovered Wash Area**



## Uncovered Wash Area

Revised September 2004

Please see <http://www.ecy.wa.gov/copyright.html> for copyright notice including permissions, limitation of liability, and disclaimer.

## **Exceptions**

- At gas stations (for charity car washes) or commercial parking lots, where it is not possible to discharge the washwater to a sanitary sewer, a temporary plug or a temporary sump pump can be used at the storm drain to collect the washwater for off-site disposal, such as to a nearby sanitary sewer.
- New and used car dealerships may wash vehicles in the parking stalls if employees use a temporary plug system to collect the washwater for disposal as stated above, or an approved treatment system for the washwater is in place.

At industrial sites, contact Ecology for NPDES Stormwater General Permit requirements even when not using soaps, detergents, and/or other chemical cleaners in washing trucks.

## **S432E: BMPs for Wood Treatment Areas**

### ***Description of Pollutant Sources***

Wood treatment includes both antistaining and wood preserving using pressure processes or by dipping or spraying. Wood preservatives include creosote, creosote/coal tar, pentachlorophenol, copper naphthenate, arsenic trioxide, malathion, or inorganic arsenicals such as chromated copper arsenate, acid copper chromate, chromate zinc chloride, and fluor-chrome-arsenate-phenol. Antistaining chemical additives include iodo-prophenyl-butyl carbamate, dimethyl sulfoxide, didecyl dimethyl ammonium chloride, sodium azide, 8-quinolinol, copper (II) chelate, sodium orthophenylphenate, 2-(thiocyanomethylthio)-benzothiazole, methylene bis- (thiocyanate), and zinc naphthenate.

Pollutant sources include: drips of condensate or preservative after pressurized treatment; product washwater (in the treatment or storage areas), spills and leaks from process equipment and preservative tanks, fugitive emissions from vapors in the process, blowouts and emergency pressure releases, and kick-back from lumber (phenomenon where preservative leaks as it returns to normal pressure). Potential pollutants typically include the wood treating chemicals, biochemical oxygen demand, suspended solids, oil and grease, benzene, toluene, ethylbenzene, phenol, chlorophenols, nitrophenols, heavy metals, and polycyclic aromatic hydrocarbons, depending on the chemical additive used.

### ***Pollutant Control Approach***

Cover and contain all wood treating areas and prevent all leaching of and stormwater contamination by wood treating chemicals. Wood treating facilities may be covered by the Industrial Stormwater General Permit (ISGP) or by an individual permit. Individual permits covering wood treatment areas include applicable source control BMPs or require the development of BMPs or a Stormwater Pollution Prevention Plan (SWPPP). Facilities covered under the ISGP must prepare and implement a SWPPP. When developing a SWPPP or BMPs, wood treating facilities should include the applicable operational and structural source control BMPs.

### ***Applicable Operational BMPs***

- Use dedicated equipment for treatment activities to prevent the tracking of treatment chemicals to other areas on the site.

- Eliminate nonprocess traffic on the drip pad. Scrub down nondedicated lift trucks on the drip pad.
- Immediately remove and properly dispose of soils with visible surface contamination (green soil) to prevent the spread of chemicals to ground water and/or surface water via stormwater runoff.
- Relocate the wood to a concrete chemical containment structure until the surface is clean and until it is drip free and surface dry if the wood contributes chemicals to the environment in the treated wood storage area.

### ***Recommended Operational BMP***

Consider using preservative chemicals that do not adversely affect receiving surface water and ground water.

### ***Applicable Structural Source Control BMPs***

- Cover and/or enclose and contain with impervious surfaces all wood treatment areas. Slope and drain areas around dip tanks, spray booths, retorts, and any other process equipment in a manner that allows return of treatment chemicals to the wood treatment process.
- Cover storage areas for freshly treated wood to prevent contact of treated wood products with stormwater. Segregate clean stormwater from process water. Convey all process water to an approved treatment system.
- Seal any holes or cracks in the asphalt areas that are subject to wood treatment chemical contamination.
- Elevate stored, treated wood products to prevent contact with stormwater run-on and runoff.
- Place dipped lumber over the dip tank, or on an inclined ramp for a minimum of 30 minutes to allow excess chemical to drip back to the dip tank.
- Place treated lumber from dip tanks or retorts in a covered paved storage area for  $\geq 24$  hours before placement in outside storage. Use a longer storage period during cold weather unless the temporary storage building is heated. Prior to moving wood outside, ensure that the wood is drip free and surface dry.

## **S433E: BMPs for Pools, Spas, Hot Tubs, and Fountains**

### ***Description of Pollutant Sources***

This section includes BMPs for pools, spas, hot tubs, and fountains used for recreational/decorative purposes that use chemicals and/or that are heated. Permittees that use pools, spas, hot tubs, and fountains as part of an industrial process should see their Industrial Stormwater General Permit.

Discharge from pools, spas, hot tubs, and fountains can degrade ambient water quality. The waters from these sources typically contain bacteria that contaminate the receiving waters. Chemicals lethal to aquatic life such as chlorine, bromine and algaecides can be found in pools, spas, hot tubs, and fountains. These waters may be at an elevated temperature and can have adverse effects on

receiving waters and to aquatic life. Diatomaceous earth backwash from swimming pool filters can clog gills and suffocate fish.

Routine maintenance activities generate a variety of wastes. Chlorinated water, backwash residues, algaecides, and acid washes are a few examples. Direct disposal of these waters to drainage systems and waters of the state is not permitted without prior treatment and approval.

The quality of any discharge to the ground after proper treatment must comply with the Washington State Department of Ecology Water Quality Standards for Groundwater, [Chapter 173-200 WAC](#).

The Washington State Department of Health and local health authorities regulate water recreation facilities, which include pools, spas, and hot tubs. Owners and operators of those facilities must comply with those regulations, policies, and procedures. Following the guidelines here does not exempt or supersede any requirements of the regulatory authorities.

### ***Pollutant Control Approach***

Many manufacturers do not recommend draining pools, spas, hot tubs, or fountains; see the facility's operation and maintenance manual. If the water feature must be drained, convey discharges (within hoses or pipes) to a sanitary sewer if approved by the local sewer authority or to a storm drain following the conditions outlined under Applicable Operational BMPs. Do not discharge to a septic system, since it may cause the system to fail. No discharge to the ground, or to surface water should occur, unless permitted by the proper regulatory authority.

### ***Applicable Operational BMPs***

- Clean the pool, spa, hot tub, or fountain regularly; maintain proper chlorine levels; and maintain water filtration and circulation. Doing so will limit the need to drain the facility.
- Manage pH and water hardness to reduce copper pipe corrosion that can stain the facility and pollute receiving waters.
- Before using copper algaecides, try less toxic alternatives. Use copper algaecides only if the other alternatives do not work. Ask a pool/spa/hot tub/fountain maintenance service or store for help resolving persistent algae problems without using copper algaecides.
- Develop and regularly update a facility maintenance plan that follows all discharge requirements.
- Dispose of unwanted chemicals properly. Many of them are hazardous wastes when discarded.
- Discharge waters originating from a pool/spa/hot tub/fountain to a sanitary sewer, if approved by the local sewer authority, local health authority or both. Do not discharge waters containing copper-based algaecides to drainage systems.
- Do not discharge water directly from a pool, spa, hot tub, fountain, process wastes, or wastewaters into storm drains except if the following conditions apply to the discharge water:
  - Dechlorinated/debrominated to  $\leq 0.1$  part per million (ppm). (Some guidance on dechlorination is provided in the *Water System Design Manual* ([DOH, 2009](#)), which also references the American Water Works Association [AWWA] standards for disinfecting water mains ([AWWA, 1999b](#)) and water storage facilities ([AWWA, 2002](#))).

Contact a supplier of pool chemicals to obtain the necessary neutralizing chemicals.

- pH-adjusted.
  - Reoxygenated if necessary.
  - Free of any coloration, dirt, suds, or algae.
  - Free of any filter media.
  - Free of acid cleaning wastes.
  - At a temperature that will prevent an increase in temperature in the receiving water. Cool heated water prior to discharge.
  - Released at a rate that can be accommodated by the receiving body (i.e., can infiltrate or be safely conveyed).
- Do not discharge swimming pool cleaning wastewater and filter backwash to the storm drain.
  - Bag diatomaceous earth (pool filtering agent) and dispose of it at a landfill.

### ***Applicable Structural Source Control BMPs***

- Ensure that the pool/spa/hot tub/fountain system is free of leaks and operates within the design parameters.
- Do not provide any permanent links to drainage systems. All connections should be visible and carefully controlled.
- If the dechlorination or selected cooling process requires the water to be stored for a time, it should be contained within the pool or appropriate temporary storage container.

## **S434E: BMPs for Dock Washing**

### ***Description of Pollutant Sources***

Washing docks (or wharves, piers, floats, and boat ramps) can result in the discharge of soaps and detergents that can be toxic to aquatic life, especially after they take on contaminants while cleaning. The Best Management Practices (BMPs) in this section do not address dry docks, graving docks, or railway cleaning operations.

### ***Pollutant Control Approach***

Use dry methods and equipment (scraping, sweeping, vacuuming) to remove debris and contaminants prior to cleaning with water to prevent these substances from entering surface water.

### ***Applicable Operational BMPs***

- Sweep or vacuum docks to minimize the need for chemical cleaners. Sweep, capture, and dispose of debris from the dock at least once per week or as needed.
- On dock areas, sweep or vacuum rather than hose down debris. Collect any hose water



generated and convey to appropriate treatment and disposal.

The following video, provided courtesy of the Port of Seattle, highlights the methods they have developed to collect hose water generated during dock washing.

Video: Dock Scrubbing at Port of Seattle (YouTube Link): <https://www.youtube.com/watch?v=7RBFdjC3K1Q>

- Try cleaning with water and a coarse cloth before using soaps or detergents.
- Use degreasers or absorbent material to remove residual grease by hand and do not allow this material to enter surface water.
- Try pressure washing using light pressure. This uses less water and decreases the need for soap and scrubbing when washing the dock. Avoid using excessive pressure, which may damage the dock or send flakes of paint and other material into the water.
- Avoid or minimize the use of petroleum distillates, chlorinated solvents, and ammoniated cleaning agents.
- If you need a cleaner, mix it in a bucket and use it to scrub down only the areas that need extra attention. Properly dispose of the dirty bucket water on shore.
- If a cleaner is needed, start with vinegar and baking soda and move to other options as needed. Spot clean using a rag if harsher cleaning products are needed.
- Keep cleaners in sealed containers. Keep cleaner containers closed securely when transporting between the shore and docks.
- During cleaning activities, if debris, substances, or washwater could enter surface waters through drains, temporarily block the drains to route water to the landward end(s) of the structure and onto vegetative areas.
- Minimize the scour impact of washwater to any exposed soil at the landward end(s) of the dock or below the dock. Place a tarpaulin over exposed soil, plant vegetation, or put berms to contain eroded soil.
- Do not place any debris and substances resulting from cleaning activities in shoreline areas, riparian areas, or on adjacent land where these substances may erode into waters of the state.
- Where treated wood associated with the structure being washed are present, use non-abrasive methods and tools that, to the maximum extent practicable, minimize removal of the creosote or treated wood fibers.
- Do not discharge emulsifiers, dispersants, solvents, or other toxic deleterious materials to waters of the state.

## **S435E: BMPs for Pesticides and an Integrated Pest Management Program**

### ***Description of Pollutant Sources***

Pesticides include herbicides, rodenticides, insecticides, and fungicides. The following are examples of pesticide uses:

- Weed control on golf course lawns, access roads, utility corridors and landscaping
- Sap stain and insect control on lumber and logs
- Rooftop moss removal
- Killing of nuisance rodents
- Fungicide application to patio decks

It is possible to release toxic pesticides such as pentachlorophenol, carbamates, and organo-metallics to the environment by leaching and dripping from treated parts, container leaks, product misuse, and outside storage of pesticide contaminated materials and equipment. Poor management of pesticides can cause appreciable stormwater contamination and unintended impacts on nontargeted organisms.

### ***Pollutant Control Approach***

Control pesticide applications to prevent contamination of stormwater. Develop and implement an integrated pest management (IPM) plan. Carefully apply pesticides, in accordance with label requirements.

### ***Applicable Operational BMPs***

- Choose the least toxic pesticide available that can reduce the infestation to acceptable levels. The pesticide should readily degrade in the environment and/or have properties that strongly bind it to the soil.
- Choose pesticides categorized by U.S. Environmental Protection Agency as reduced risk, for example, the herbicide imazamox.
- Train employees on proper application of pesticides and disposal practices.
- Follow manufacturers' application guidelines and label requirements.
- Do not apply pesticides in quantities that exceed the limits on the Federal Insecticide, Fungicide, and Rodenticide Act (FIFRA) label. Avoid excessive application of chemical.
- Conduct spray applications during weather conditions as specified in the label requirements and applicable local and state regulations. Do not apply during rain or immediately before expected rain (unless the label directs such timing).
- When possible apply pesticides during the dry season so that the pesticide residue is degraded prior to the next rain event.

- Clean up any spilled pesticides immediately. Do not hose down to a storm drain, conveyance ditch, or water body.
- Remove weeds/vegetation in stormwater ditches, stormwater facilities, and drainage systems by hand or other mechanical means and only use pesticides as a last resort.
- If possible, do not spray pesticides within 100 feet of water bodies. Spraying pesticides within 100 feet of water bodies including any drainage ditch or channel that leads to open water may have additional regulatory requirements beyond just following the pesticide product label. Additional requirements may include the following:
  - Obtaining a discharge permit from the Washington State Department of Ecology (Ecology)
  - Obtaining a permit from the local jurisdiction
  - Using an aquatic labeled pesticide and adjuvant
- Flag all sensitive areas including wells, creeks, and wetlands prior to spraying.
- Post notices and delineate the spray area prior to the application, as required by the local jurisdiction, or by Ecology.
- See [S411E: BMPs for Landscaping and Lawn/Vegetation Management](#) and use pesticides only as a last resort.
- Conduct any pest control activity at the life stage when the pest is most vulnerable. For example, if it is necessary to apply *Bacillus thuringiensis* to control tent caterpillars, apply it to the material before the caterpillar's cocoon is formed, or it will be ineffective. Any method used should be site-specific and not used wholesale over a wide area.
- Mix pesticides and clean the application equipment under cover in an area where accidental spills will not enter surface or ground waters and will not contaminate the soil.
- The pesticide application equipment must be capable of immediate shutoff in the event of an emergency.
- Implement a pesticide-use plan and include the following at a minimum:
  - A list of selected pesticides and their specific uses
  - Brands and formulations of the pesticides
  - Application methods and quantities to be used
  - Equipment use and maintenance procedures
  - Safety, storage, and disposal methods
  - Monitoring, record keeping, and public notice procedures. All procedures shall conform with the requirements of [Chapter 17.21 RCW](#) and [Chapter 16-228 WAC](#).
- Develop and implement an IPM program. The following steps are adapted from *Least Toxic*

*Pest Management for Lawns* ([Daar, 1992](#)):

1. Correctly identify problem pests and understand their life cycle.
  - Learn more about the pest.
  - Observe it and pay attention to any damage that may be occurring.
  - Learn about the life cycle.
    - Many pests are only a problem during certain seasons or can only be treated effectively in certain phases of the life cycle.
2. Establish tolerance thresholds for pests.
  - Decide on the level of infestation that must be exceeded before treatment needs to be considered. Pest populations under this threshold should be monitored but do not need treatment.
3. Monitor to detect and prevent pest problems.
  - Monitor regularly to anticipate and prevent major pest outbreaks.
  - Conduct a visual evaluation of the lawn or landscape's condition. Take a few minutes before mowing to walk around and look for problems.
  - Keep a notebook, record when and where a problem occurs, then monitor for it at about the same time in future years.
  - Specific monitoring techniques can be used in the appropriate season for some potential problem pests, such as European crane fly.
4. Modify the maintenance program to promote healthy plants and discourage pests.
  - Review your landscape maintenance practices to see if they can be modified to prevent or reduce the problem.
  - A healthy landscape is resistant to most pest problems. Lawn aeration and overseeding along with proper mowing height, fertilization, and irrigation will help the grass out-compete weeds.
  - Correcting drainage problems and letting soil dry out between waterings in the summer may reduce the number of crane fly larvae that survive.
5. If pests exceed the tolerance thresholds:
  - Consider the most effective management options concurrent with reducing impacts on the environment. This may mean chemical pesticides are the best option in some circumstances.
  - Consider the use of physical, mechanical, or biological controls.
  - Study to determine what products are available and choose a product that is the least toxic and has the least nontarget impact.

6. Evaluate and record the effectiveness of the control and modify maintenance practices to support lawn or landscape recovery and prevent recurrence.
  - Keep records
  - Note when, where, and what symptoms occurred or when monitoring revealed a potential pest problem.
  - Note what controls were applied and when and the effectiveness of the control.
  - Monitor next year for the same problems.

### **Recommended Operational BMPs**

- Use manual pest control strategies such as physically scraping moss from rooftops, high-pressure sprayers to remove moss, and rodent traps.
- Consider alternatives to the use of pesticides such as covering or harvesting weeds, substitute vegetative growth, and manual weed control/moss removal.
- Consider the use of soil amendments, such as compost, that are known to control some common diseases in plants, such as *Pythium* root rot, ashy stem blight, and parasitic nematodes.
- Once a pesticide is applied, evaluate its effectiveness for possible improvement. Records should be kept showing the effectiveness of the pesticides applied.
- Follow the FIFRA label requirements for disposal. If the FIFRA label does not have disposal requirements, the rinsate from equipment cleaning and/or from triple-rinsing of pesticide containers should be used as product or recycled into product.
- Develop an adaptive management plan and annual evaluation procedure that includes the following (adapted from [Daar, 1992](#)):
  - A review of the effectiveness of pesticide applications.
  - Impact on buffers and sensitive areas, including potable wells. If individual or public potable wells are located in the proximity of commercial pesticide applications, contact the regional Ecology hydrogeologist to determine if additional pesticide application control measures are necessary.
  - Public concerns.
  - Recent toxicological information on pesticides used/proposed for use.

### **Additional Information**

Washington pesticide law requires most businesses that commercially apply pesticides to the property of another to obtain a Commercial Applicator license from the Washington State Department of Agriculture.

**For more information:** See the Pesticide Information Center Online (PICOL) databases at the following web address:

<http://picol.cahe.wsu.edu/LabelTolerance.html>

## **S436E: BMPs for Color Events**

### ***Description of Pollutant Sources***

Color events are charity, religious, or commercial events that involve the use of powdered (typically cornstarch based) and/or liquid dyes (see [Figure 8.17: Powdered Dyes at Color Events](#)). Because they typically occur outside, there is a high likelihood of the color material entering drainage systems and surface water unless measures are taken to prevent these illicit discharges from occurring.

“Biodegradable” and “nontoxic” do NOT mean that a substance can go into storm drains or water bodies. The dye material can harm aquatic organisms by altering water quality and chemistry. State and federal environmental laws require local jurisdictions to prohibit non-stormwater discharges to storm drains. Dye material and any washwater are prohibited discharges.

### ***Pollutant Control Approach***

Plan for the event. Control the application areas for the powder or liquid dyes. Block off storm drain inlets prior to the event. Clean up the areas immediately after the event.

**Figure 8.17: Powdered Dyes at Color Events**



## Powdered Dyes at Color Events

Revised June 2016

Please see <http://www.ecy.wa.gov/copyright.html> for copyright notice including permissions, limitation of liability, and disclaimer.

## ***Applicable Operational BMPs***

### **Pre-Event**

- Create a map of your event that includes the following:
  - Event route
  - Nearby streams, lakes, and ponds
  - Start and finish areas
  - Color application stations/areas
  - Storm drains and open drainage system features (e.g., ditches, swales, bioretention) at the color application start and finish areas
- Create a pollution plan that details the following:
  - Measures taken to ensure that NO dye material, either during or after the event, will enter the drainage system
  - How all dye material will be removed and disposed of
  - What will happen in the event of rain (including addressing localized flooding, runoff, and collection of the stormwater)
  - Emergency numbers for the local jurisdiction in case dye material does enter the storm drain or water body
- Use handheld brooms to complete the initial cleanup of paved surfaces. Follow with use of a vacuum sweeper truck on roads.
- Contract with a commercial street sweeping firm to clean paved surfaces. Have a storm drain cleaning contractor on call for discharges to storm drains or emergency cleanup if necessary.
- Ensure that the commercial street sweeping firm has a plan in place for the proper disposal of sweepings from the event and associated air filters.
- Ensure that all cleanup will be completed prior to the next forecasted rainfall, or no later than 24 hours after the race event, and that the contractor will have enough equipment and staff on hand for the cleanup.
- Request a copy of the dye product's Safety Data Sheet (SDS) from the manufacturer or supplier. Review the SDS for potential safety and environmental hazards.
- Comply with local jurisdiction event permit requirements that contain stormwater pollution prevention BMPs. If no local event permit is required, provide to the local jurisdiction in charge of stormwater drainage and/or surface water management, in plenty of time ( $\geq 2$  weeks) prior to the event:
  - Copies of the map
  - Pollution prevention plan



- Commercial cleaning contract
- Dye SDSs
- Names and contact information of the event officials for both during and after the event

### **Preventing Runoff From Entering Drainage Systems and Water Bodies**

- Protect storm drains by using berms, covering the drains, and using catch basin covers.
- Use care when removing berms, covers, and tarpaulins to ensure no dye enters the storm drains.
- Prohibit participants from throwing dye within 100 feet of any stream or other surface water body.
- Prohibit participants from throwing dye within 100 feet of any open stormwater feature (e.g., ditch, swale, bioretention, detention pond)
- Set up color stations  $\geq$  100 feet away from any surface water or open stormwater BMP.
- The route, start, finish, and color application stations must be  $\geq$  100 feet away from any permeable pavement or the permeable pavement must be completely covered.
- If the event will be held on a small, contained area, cordon off the area and place enough covers on the ground to cover the entire site. If possible, contain the color application to grassy areas where ground covers are unnecessary.

### **Event Cleanup**

- Dry off tarpaulins and stained wet pavement with towels or absorbent pads.
- Use brooms or street sweepers to clean up paved areas. The fineness of the material may require sweepers with dust control systems.
- Do not use blowers to move dye material.
- Do not use hoses or pressure washers to rinse excess dye off of tarpaulins, sidewalks or paved areas. If it becomes necessary to use water to clean surfaces, all the water must be collected and disposed of to the sanitary sewer system, with approval from the local sewer agency.
- Call the local spill response hotline immediately (24 hours per day, 7 days per week) if any colored water enters a storm drain or water body.
- Dispose of the collected sweeping materials, cleaning materials, and air filters appropriately.
- All litter and debris must be picked up and properly disposed of.
- All cleanup must be done within 24 hours of the race event.

## **S438E: BMPs for Construction Demolition**

### ***Description of Pollutant Sources***

This activity applies to removal of existing buildings and other structures by controlled explosions, wrecking balls, or manual methods, and subsequent clearing of the rubble. The loose debris may contaminate stormwater.

Pollutants of concern include toxic organic compounds, hazardous wastes, high pH, heavy metals, and suspended solids.

### ***Pollutant Control Approach***

Do not expose hazardous materials to stormwater. Regularly clean up debris that can contaminate stormwater. Protect the stormwater drainage system from dirty runoff and loose particles. Sweep paved surfaces daily. Educate employees about the need to control site activities.

### ***Applicable Operational BMPs***

- Identify, remove, and properly dispose of hazardous substances from the building before beginning construction demolition activities that could expose them to stormwater. Such substances could include polychlorinated biphenyls (PCBs), asbestos, lead paint, mercury switches, and electronic waste.
- Educate employees about the need to control site activities to prevent stormwater pollution, and also train them in spill cleanup procedures.
- Keep debris containers, dumpsters, and debris piles covered.
- Place storm drain covers, or a similarly effective containment device, on all nearby drains to prevent dirty runoff and loose particles from entering the stormwater drainage system.
  - Place the covers (or devices) at the beginning of the workday.
  - Collect and properly dispose of the accumulated materials before removing the covers (or devices) at the end of the workday.
  - Use dikes, berms, or other methods to protect overland discharge paths from runoff if stormwater drains are not present.
- Sweep street gutters, sidewalks, driveways, and other paved surfaces in the immediate area of the demolition at the end of each workday. Collect and properly dispose of loose debris and garbage.
- Lightly spray water (such as from a hydrant or water truck) throughout the site to help control windblown fine materials such as soil, concrete dust, and paint chips. Control the amount of dust control water so that runoff from the site does not occur, yet dust control is achieved. Do not use oils for dust control.

### ***Recommended Operational BMPs***

- Construct a wall to prevent stray building materials and dust from escaping the area during demolition.

- Schedule demolition to take place at a dry time of the year to prevent stormwater runoff from the demolition site.

## **S439E: BMPs for In-Water and Over-Water Fueling**

### ***Description of Pollutant Sources***

The BMPs in this section apply to businesses and public agencies that operate a facility used for the transfer of fuels from a stationary pumping station to vehicles or equipment in water. This type of fueling station includes aboveground or underground fuel storage facilities, which may be permanent or temporary. Fueling stations include facilities such as, but not limited to, commercial gasoline stations, port facilities, marinas, private fleet fueling stations, and boatyards.

Typically, stormwater contamination at fueling stations is caused by leaks or spills of fuels, lubrication oils, and fuel additives. These materials contain organic compounds, oil and grease, and metals that can be harmful to humans and aquatic life.

Most fuel dock spills are small and result from overfilling boat fuel tanks, burps from air vent lines, and drips from the pump nozzle as it is being returned to the pump.

### ***Pollutant Control Approach***

Provide employees with proper training and use spill control devices to prevent the discharge of pollutants in the receiving water or the drainage system.

### ***Applicable Operational BMPs***

#### **Applicable Operational BMPs for Fuel Docks**

- Have an employee supervise the fuel dock.
- Use automatic shutoff nozzles and promote the use of “whistles” and fuel/air separators on air vents or tank stems of inboard fuel tanks to reduce the amount of fuel spilled into receiving waters during fueling of boats.
- Have the boat operator place an absorbent pad or suction cup bottle under the vent(s) to capture fuel spurts from the vent.
- Never block open the fuel nozzle trigger and always disable hands-free clips to ensure the boater remains with the nozzle to prevent overfilling. Hands-free clips are not allowed in Washington, per [WAC 296-24-33015](#).
- Always keep the nozzle tip pointing up and hang the nozzle vertically when not in use.
- Discourage operators from “topping off” ( $\leq 90\%$  capacity). Fuel expands and can slosh out of the vent when temperatures rise or waters become choppy.
- When handing over the nozzle, wrap an absorbent pad around the nozzle end or plug inside the nozzle end to prevent fuel in the nozzle from spilling.
- Create a regular inspection, maintenance, and replacement schedule for fuel hoses, pipes, and tanks. Have staff walk the dock fuel lines from dispenser to tank to look for signs of

leakage at joints and determine hose condition from end to end.

- Train staff on proper fueling procedures.
- Post readable refueling directions, BMPs, and emergency protocols.
- Always have a “Spills Aren’t Slick” sign with emergency spill reporting numbers clearly visible. Marinas on land leased from the Washington State Department of Natural Resources are required to post these signs.
- Use of detergents to disperse a fuel spill is illegal, and the fines are expensive. Ensure that customers do not use soaps in the event of a spill. Use oil absorbent pads instead.
- Display “No Smoking” signs on fuel docks.
- Do not allow self-service on a marina dock without some means of controlling the dock activity. According to *NFPA 30A, Code for Motor Fuel Dispensing Facilities and Repair Garages*, each facility must have an attendant on duty to supervise, observe, and “control” the operation when open for business ([NFPA, 2018](#)). This can be done by camera, intercom, and shutoff abilities in the office. However, this can lead to complacency, and nothing can replace having an attendant on the dock to attend to emergencies when they occur.
- Install a tank and leak detection monitoring system that shuts off the pump and fuel line when a leak is sensed.
- Install personal watercraft floats at fuel docks to help boaters stabilize their vessel and refuel without spilling.
- Provide a spill containment equipment storage area where materials are easily accessible and clearly marked.
- During fueling operations, visually monitor the liquid level indicator to prevent the tank from being overfilled.
- The maximum amount of product received must not exceed 95% capacity of the receiving tank.

### **Applicable Operational BMPs for Fueling by Portable Container**

- Have boats fuel on shore or at a fuel dock rather than transport fuel from an upland facility to the boats. Use handheld fueling containers or “jerry cans” only when necessary, when on shore, or when at-dock fueling is not practical.
- Always refill portable fuel containers on the pavement or dock to ensure a good electrical ground. Although the deck of the boat may seem stable, static electricity can build up and cause a spark.
- On the dock, put an absorbent pad under the container and wrap an absorbent pad around the fuel fill—this can easily be done by putting a hole in the pad.
- Ensure the nozzle stays in contact with the tank opening.
- When transferring fuel from a portable can, use a fuel siphon with a shutoff feature. If a siphon

is not available, a nozzle/spout with a shutoff is a good alternative.

- Since fueling boats with a portable container can take time, make sure the container is comfortable to carry, hold, and balance.
- Use a high-flow funnel. Funnels can help prevent spills by making a larger opening for fueling.
- Place a plug of absorbent pad or paper towel in the nozzle when not in use to capture any extra drops that accumulate.
- Fuel slowly and pour deliberately and watch the container (especially the nozzle mechanism) for signs of wear.
- Store portable fuel tanks out of direct sunlight and keep in a cool, dry place to minimize condensation.

## **S440E: BMPs for Pet Waste**

### ***Description of Pollutant Sources***

Pets and pet-care can generate pollutants from waste, animal washing, and cage or kennel cleaning. Pet waste that washes into lakes or streams begins to decay, using up oxygen and releasing ammonia. Low oxygen levels and ammonia combined with warm water can kill fish. Pet waste also contains nutrients that encourage weed and algae growth, and contribute to low oxygen and high pH in waters we use for swimming, boating and fishing. Most importantly, pet waste can carry viruses and bacteria that could cause disease and lead to beach or shellfish harvesting closures.

### ***Pollutant Control Approach***

Use a plastic bag or pooper scooper to clean up after pets. Properly dispose of pet waste.

### ***Recommended Operational BMPs for Pet Owners***

- Regularly pick up and dispose of pet waste deposited on walks and at home.
- Put pet waste in a securely closed bag and deposit it in the trash. Do not place pet waste in yard waste containers because pet waste may carry diseases, and composting may not kill disease-causing organisms.
- Do not compost or use pet waste as fertilizer. Harmful bacteria, worms, and parasites that can transmit disease can live in the soil for years even after the solid portion of the pet waste has dissolved.
- Do not dispose of unused pet pharmaceuticals in a storm drain, in a toilet, or down a sink. Check with your local refuse collector for proper disposal locations of pet medications.
- When cleaning out cages and kennels, dispose of wash water down the toilet or a mop sink. Otherwise, wash directly over lawn areas or make sure the wash water drains to a vegetated area.
- Bathe pets indoors or in a manner that wash water won't be discharged to storm drains, ditches, or surface waters of the state.

## ***Recommended Operational BMPs for Recreation Areas and Multi-Family Properties***

- Post signs at recreation areas and multi-family properties (that allow pets) reminding residents and visitors to pick up after their pets.
- Carefully consider the placement of pet waste stations at recreation sites and near multi-family properties that allow pets. Choose locations convenient for dog walkers to pick up a bag at the start of their walk and locations for them to dispose of it at mid-walk or at the end of their walk.
- Check pet waste stations on a regular basis to keep pet waste bags stocked and disposal stations empty. Consider signage to keep regular trash out of pet waste disposal stations to avoid filling them too quickly. Make sure pet waste disposal stations have a cover to keep out water.
- At multi-family properties with roof-top dog runs, ensure that stormwater from the dog run is not discharged to the stormwater system. Check with the local jurisdiction regarding roof-top dog run connections to sanitary sewer.

**Figure 8.18: Example of a Pet Waste Baggie Station**



### Example of a Pet Waste Baggie Station

Revised November 2017

Please see <http://www.ecy.wa.gov/copyright.html> for copyright notice including permissions, limitation of liability, and disclaimer.

**Figure 8.19: Examples of Pet Waste Signs**



## Examples of Pet Waste Signs

Revised July 2019



## **S441E: BMPs for Potable Water Line Flushing, Water Tank Maintenance, and Hydrant Testing**

### ***Description of Pollutant Sources***

Flushing is a common maintenance activity used to improve pipe hydraulics and to remove pollutants in systems. Flushing done improperly can result in the discharge of solids to receiving waters. Hydrant testing may result in the discharge of rust particles.

**Note:** Chemicals used in line flushing and tank maintenance are highly toxic to aquatic organisms and can degrade receiving waters.

### ***Pollutant Control Approach***

Dechlorinate and pH adjust water used for flushing, tank maintenance, or hydrant testing. Dispose of the water to the sanitary sewer if possible.

### ***Applicable Operational BMPs***

- Remove solids from associated curbs and gutters before flushing water. Use erosion and sediment control BMPs such as [BMP C235E: Wattles](#) and [BMP C220E: Inlet Protection](#) to collect any solids resulting from flushing activities.
- If using super chlorination or chemical treatment as part of flushing, discharge water to the sanitary sewer. If sanitary sewer is not available, the water may be allowed to infiltrate the ground as long as all of the following apply:
  - The water is dechlorinated to a total residual chlorine of  $\leq 0.1$  parts per million (ppm).
  - The water quality standards are met.
  - A diffuser is used to prevent erosion.
  - The water does not cross property lines.
- Discharging water to a drainage system requires approval from the local jurisdiction. Check with the local jurisdiction to determine its requirements for approval. Most jurisdictions will require the water to be dechlorinated to a total residual chlorine concentration of  $\leq 0.1$  ppm and pH adjusted if necessary. Water must be volumetrically and velocity controlled to prevent resuspension of sediments in the drainage system.

### ***Recommended Operational BMPs***

- Have fire hydrant flushing coincide with storm drain flushing to make the best use of water.
- If possible, design flushing to convey accumulated material to strategic locations, such as to the sanitary sewer or to a runoff treatment BMP; thus, preventing resuspension and overflow of a portion of the solids during storm events.
- If possible, conduct flushing and tank maintenance activities on nonrainy days and during the time of year that poses the least risk to aquatic biota.

## **Recommended Treatment BMPs**

- Treatment for dechlorinating can include an application of a stoichiometric quantity of the following:
  - Ascorbic acid, sodium ascorbate (vitamin C)
  - Calcium thiosulfate
  - Sodium sulfite tablets
  - Sodium thiosulfate
  - Sodium bisulfite
  - Alternative dechlorination solutions
- Do not overapply dechlorination agents. This can deplete the dissolved oxygen concentration and reduce the pH in discharge/receiving waters.

## **S442E: BMPs for Labeling Storm Drain Inlets on Your Property**

### **Description of Pollutant Sources**

Waste materials dumped into storm drain inlets can have severe impacts on receiving waters. Posting notices regarding discharge prohibitions at storm drain inlets can prevent waste dumping. Storm drain signs and stencils are highly visible source controls that are typically placed directly adjacent to storm drain inlets.

### **Pollutant Control Approach**

The stencil, affixed sign, or metal grate contains a brief statement that prohibits dumping of improper materials into the urban runoff conveyance system. Storm drain messages have become a popular method of alerting the public about the effects of and the prohibitions against waste disposal.

### **Applicable Operational BMPs**

- Label storm drain inlets in residential, commercial, industrial areas, and any other areas where contributions or dumping to storm drains is likely (see [Figure 8.20: Storm Drain Inlet Labels](#)).
- Stencil or apply storm drain markers adjacent to storm drains to help prevent the improper disposal of pollutants. Or, use a storm drain grate stamped with warnings against polluting.
- Place the marker in clear sight facing toward anyone approaching the inlet from either side.
- Use a brief statement and/or graphical icons to discourage illegal dumping. Examples:
  - “No Dumping – Drains to Stream”
  - “Dump No Waste – Drains to Lake”
- Check with your local jurisdiction to find out if they have approved specific signage and / or

storm drain message placards for use. Consult the local jurisdiction to determine specific requirements for placard types and methods of application.

- Maintain the legibility of markers and signs. Signage on top of curbs tends to weather and fade. Signage on face of curbs tends to be worn by contact with vehicle tires and sweeper brooms.
- When painting stencils or installing markers, temporarily block the storm drain inlet so that no pollutants are discharged from the labeling activities.

### ***Recommended Operational BMPs***

Use a stencil in addition to a storm drain marker or grate to increase visibility of the message.

**Figure 8.20: Storm Drain Inlet Labels**



## Storm Drain Inlet Labels

Revised October 2017

Please see <http://www.ecy.wa.gov/copyright.html> for copyright notice including permissions, limitation of liability, and disclaimer.

## **S443E: BMPs for Fertilizer Application**

### ***Description of Pollutant Sources***

Poor application of fertilizers can cause appreciable stormwater contamination. Fertilizers can leach phosphorus, nitrogen, and coliform bacteria. Fertilizers can contribute to algae blooms, increase nutrient concentrations, and deplete oxygen in receiving waters.

### ***Pollutant Control Approach***

Minimize the amount of fertilizer necessary to maintain vegetation. Control the application of fertilizer to prevent the discharge of stormwater pollution.

### ***Applicable Operational BMPs***

- Apply the minimum amount of slow-release fertilizer necessary to achieve successful plant establishment.
- Do not fertilize when the soil is dry or during a drought.
- Never apply fertilizers if it is raining or about to rain.
- Do not apply fertilizers within 3 days prior to predicted rainfall. The longer the period between fertilizer application and either rainfall or irrigation, the less fertilizer runoff occurs. Determine the proper fertilizer application for the types of soil and vegetation involved.
- Follow manufacturers' recommendations and label directions.
- Train employees on the proper use and application of fertilizers.
- Keep fertilizer granules off impervious surfaces. Clean up any spills immediately. Do not hose down to a storm drain, conveyance ditch, or water body.
- If possible, do not fertilize areas within 100 feet of water bodies including wetlands, ponds, and streams.
- Avoid fertilizer applications in stormwater ditches, stormwater facilities, and drainage systems.
- In areas that drain to sensitive water bodies, apply no fertilizer at commercial and industrial facilities, to grass swales, filter strips, or buffer areas unless approved by the local jurisdiction.
- Turfgrass is most responsive to nitrogen fertilization, followed by potassium and phosphorus.
- Use slow-release fertilizers such as methylene urea, isobutylidene, or resin-coated fertilizers when appropriate, generally in the spring. Use of slow-release fertilizers is especially important in areas with sandy or gravelly soils.
- Apply fertilizers in amounts appropriate for the target vegetation and at the time of year that minimizes losses to surface and ground waters.
- Time the fertilizer application to periods of maximum plant uptake. The Washington State Department of Ecology generally recommends application in the fall and spring, although

Washington State University turf specialists recommend four fertilizer applications per year.

Do not use turf fertilizers containing phosphorus unless a soil sample analysis taken within the past 36 months indicates the soil of the established lawn is deficient in phosphorus. For more information about restrictions on turf fertilizers containing phosphorus, see the Washington State Department of Agriculture Restrictions on Turf Fertilizers Containing Phosphorus web page at the following address:

<https://agr.wa.gov-/pestfert/fertilizers/phosturffert.aspx#UseTurfFertilizersContainingPhosphorous>

### ***Recommended Operational BMPs***

Test soils to determine the correct fertilizer application rates.

- Evaluation of soil nutrient levels through regular testing ensures the best possible efficiency and economy of fertilization.
- Fertilization needs vary by site depending on plant, soil, and climate conditions.
- Choose organic fertilizers when possible.
- For details on soils testing, contact the local conservation district, a soils testing professional, or a Washington State University Extension office.

## **S444E: BMPs for the Storage of Dry Pesticides and Fertilizers**

### ***Description of Pollutant Sources***

Pesticides such as pentachlorophenol, carbonates, and organometallics can be released to the environment as a result of container leaks and outside storage of pesticide-contaminated materials and equipment. Inappropriate management of pesticides or fertilizers can result in stormwater contamination. Runoff contaminated by pesticides and fertilizers can severely degrade streams and lakes and adversely affect fish and other aquatic life.

### ***Pollutant Control Approach***

Store fertilizer and pesticide properly to prevent stormwater contamination.

### ***Applicable Structural BMPs***

Store pesticides and fertilizers in enclosed or covered impervious containment areas.

### ***Applicable Operational BMPs***

- Containers and bags must be covered, intact, and off the ground.
- Store all material so that it cannot come into contact with water.
- Immediately clean up any spilled fertilizer or pesticides.
- Keep pesticide and fertilizer contaminated waste materials in designated covered and contained areas and dispose of properly.

- Store and maintain spill cleanup materials near the storage area.
- Sweep paved storage areas as needed. Collect and dispose of spilled materials. Do not hose down the area.
- Do not discharge pesticide contaminated stormwater or spills/leaks of pesticides to storm drains.
- Comply with [WAC 16-228-1220](#) and [Chapter 16-229 WAC](#).

## **S445E: BMPs for Temporary Fruit Storage**

### ***Description of Pollutant Sources***

This activity applies to businesses that temporarily store fruits and vegetables outdoors prior to or after packing, processing, or sale, or that crush, cut, or shred fruits or vegetables for wines, frozen juices, and other food and beverage products.

Activities involving the storage or processing of fruits, vegetables, and grains can potentially result in the delivery of pollutants to stormwater. Potential pollutants of concern from all fruit and vegetable storage and processing activities include nutrients, suspended solids, substances that increase biochemical oxygen demand, and color. These pollutants must not be discharged to the drainage system or directly into receiving waters.

### ***Pollutant Control Approach***

Store and process fruits and vegetables indoors or under cover whenever possible. Educate employees about proper procedures. Cover and contain operations and apply good housekeeping and preventive maintenance practices to prevent the contamination of stormwater.

### ***Applicable Operational BMPs***

- Educate employees on the benefits of maintaining a clean storage area.
- Keep fruits, vegetables, and grains stored outside for longer than a day in plastic bins or in bins lined with plastic. The edge of the plastic liner should be higher than the amount of fruit stored or should drape over the side of the bin.
- Dispose of rotten fruit, vegetables, and grains in a timely manner (typically, within a week).
- Make sure all outside materials that have the potential to leach or spill to the drainage system are covered, contained, or moved to an indoor location. For fruits, vegetables, and grains stored outside for a week or more, cover with a tarpaulin or other waterproof material. Make sure coverings are secured from wind.
- Minimize the use of water when cleaning produce to avoid excess runoff.
- Sweep or shovel storage and processing areas daily to collect dirt and fruit and vegetable fragments for proper disposal. Keep hosing to a minimum.
- Keep cleanup materials, such as brooms and dustpans, near the storage area.
- If a holding tank is used for the storage of wastewater, pump out the contents before the tank

is full and dispose of wastewater to a sanitary sewer or approved wastewater treatment system.

### ***Applicable Structural BMPs***

Enclose the processing area in a building or shed or cover the area with provisions for stormwater run-on prevention. Alternatively, pave and slope the area to drain to the sanitary sewer, holding tank, or process treatment system collection drain.

### ***Recommended Structural BMPs***

- Cover outdoor storage areas for fruits and vegetables.
- Use a containment curb, dike, or berm to prevent off-site runoff from storage or processing areas and to prevent stormwater run-on.

## **S446E: BMPs for Well, Utility, Directional, and Geotechnical Drilling**

### ***Description of Pollutant Sources***

This activity applies to drilling water wells and utilities, environmental protection and monitoring wells, and geotechnical borings that use machinery in the drilling. It does not apply to the use of devices such as hand augers, or for large structural drilling such as drilled shafts.

Drilling activities can expose soil and contaminated soil. These activities may cause the discharge of stormwater contaminated with sediments and other contaminants. This risk increases when drilling in areas with contaminated soils.

### ***Pollutant Control Approach***

Reduce sediment runoff from drilling operations.

### ***Applicable Operational BMPs***

- Obtain permits for drilling activities, and for clearing and grading the access routes and the work site.
- Protect environmentally sensitive areas (streams, wetlands, floodplains, floodways, erosion hazards, and landslide hazards) within the area of influence of the work site.
- Mitigate potential impacts on surrounding areas and/or the drainage system.
- For horizontal directional drilling, take measures to capture and contain drilling fluids.
- Equip the driller to quickly respond to unusual conditions that may arise.
- Locate and prepare access roadways to minimize the amount of excavation and the potential for erosion.
- Contain accumulated uncontaminated water and sediment on-site and pump into a storage tank or direct through a geotextile filtration system (or equivalent system) before discharging to the surrounding ground surface. Contaminants may include, but are not limited to, hydraulic



fluids, contaminants in the soil and/or ground water, polymers, and other drilling fluid additives.

- Keep all sediment-laden water out of storm drains and surface waters. If sediment-laden water does escape from the immediate drilling location, block flow to any nearby receiving waters or catch basins using fabric, inlet protections, sand bags, erosion fences, or other similar methods.
- Divert any concentrated flows of water into the site using sandbags or check dams upslope from the site.
- Dispose of soil cuttings and accumulated sediment appropriately. If cuttings or other soils disturbed in the drilling process are to be temporarily stockpiled on site, they must be covered and surrounded by a berm or filter device.
- Stabilize exposed soils at the end of the job, using mulch or other erosion control measures.
- Contain spent drilling slurry on-site and allow it to dewater, or haul to an appropriate, approved disposal site.
- Restore disturbed areas with mulch (see [BMP C121E: Mulching](#)) and seeding or hydroseeding (see [BMP C120E: Temporary and Permanent Seeding](#)).

## **S447E: BMPs for Roof Vents**

### ***Description of Pollutant Sources***

This activity applies to processes that vent emissions to the roof and/or the accumulation of pollutants on roofs. Processes of special concern are stone cutting, metal grinding, spray painting, paint stripping, galvanizing and electroplating. Pollutants from these processes may build up on roofs and may pollute stormwater roof runoff.

### ***Pollutant Control Approach***

Evaluate the potential sources of stormwater pollutants and apply source control BMPs where feasible.

### ***Applicable Operational BMPs***

- Identify processes that are vented and may contribute pollutants to the roof. Pollutants of concern include and are not limited to the following:
  - Metal dust
  - Grease from food preparation
  - Solvents
  - Hydrocarbons
  - Fines
  - Stone dust

- Look for chemical deposition around vents, pipes, and other surfaces.
- Install and maintain appropriate source control measures such as air pollution control equipment (filters, scrubbers, and other treatment). ([City of San José, 2004](#))
  - Check that your scrubber solution is appropriate for the chemistry of the fumes.
  - Install vent covers and drip pans where there are none.
  - Prevent leaks in pipefittings and containment vessels with routine maintenance.
- Consider instituting operational or process changes to reduce pollution.
- If proper installation and maintenance of air pollution control equipment does not prevent pollutant fallout on your roof, additional treatment of the roof runoff may be necessary.
  - Install/provide appropriate devices for roof runoff before it is discharged off-site. This may include approved runoff treatment BMPs or structural stormwater treatment BMPs.
- Maintain air filters and pollution control equipment on a regular basis to ensure they are working properly. (An odor inside the building that originated outside the building indicates that the pollution control equipment may need maintenance or evaluation.)
- When cleaning accumulated emissions from rooftops, collect the washwater and loose materials using a sump pump, wet vacuum, or similar device. Discharge the collected runoff to the sanitary sewer after approval by the local sewer authority or have a waste disposal company remove it.

## **S449E: BMPs for Nurseries and Greenhouses**

### ***Description of Pollutant Sources***

These BMPs are for use by commercial container plant, greenhouse grown, and cut foliage production operations. Common practices at nurseries and greenhouses can cause elevated levels of phosphorus, nitrogen, sediment, bacteria, and organic material that can contribute to the degradation of water quality.

### ***Pollutant Control Approach***

Minimize the pollutants that leave the site by controlling the placement of materials, stabilizing the site, and managing irrigation water.

### ***Applicable Operational BMPs***

- Establish nursery composting areas, soil storage, and mixing areas  $\geq 100$  feet away from any stream or other surface water body and as far away as possible from drainage systems.
- Do not dispose of collected vegetation into receiving waters or drainage systems.
- Do not blow, sweep, or otherwise allow vegetation or other debris into the drainage system.
- Regularly clean up spilled potting soil to prevent its movement, especially if fertilizers and

pesticides are incorporated ([Haver, 2014](#)).

- Use soil mixing and layering techniques with composted organic material to reduce herbicide use and watering.
- Use soil incorporated with fertilizers and/or pesticides immediately; do not store for extended periods ([Haver, 2014](#)).
- Cover soil storage and compost storage piles. See [S429E: BMPs for Storage or Transfer \(Outside\) of Solid Raw Materials, By-Products, or Finished Products](#).
- Dispose of pathogen-laced potting substrate and diseased plants appropriately.
- Place plants on gravel, geotextile, or weed cloth to allow infiltration and minimize erosion, including inside greenhouse structures ([Haver, 2014](#)).
- Properly reuse, recycle, or dispose of used polyfilm, containers, and other plastic-based products so that they do not collect stormwater ([FDACS, 2014](#)).
- Evaluate and manage irrigation to reduce runoff, sediment transport, and erosion.
  - Place irrigation inputs to keep moisture primarily in the plant's root zone. This will significantly reduce nutrient-related impacts from fertilizers ([FDACS, 2014](#)).
  - Avoid overirrigating. This may exceed the soil's water-holding capacity and lead to runoff or leaching ([FDACS, 2014](#)).
  - Consider and adjust as needed the uniformity of application, the amount of water retained within the potting substrate, and the amount of water that enters containers compared to that which exits the containers and/or falls between containers ([FDACS, 2014](#)).
  - Consolidate containers and turn off irrigation in areas not in production. This may require individual on/off valves at each sprinkler head ([Haver, 2014](#)).
  - Based on the stage of plant growth, space containers and flats as close as possible to minimize the amount of irrigation water that falls between containers ([FDACS, 2014](#)).
  - Group plants of similar irrigation needs together ([FDACS, 2014](#)).
  - Consider minimizing water losses by using cyclic irrigation (multiple applications of small amounts) ([FDACS, 2014](#)).
  - Consider using subirrigation systems (e.g., capillary mat, ebb-and-flow benches, and trays or benches with liners); these systems can conserve water and reduce nutrient loss, particularly when nutrients are supplied in irrigation water that is reused ([FDACS, 2014](#)).
  - Refer to [S450E: BMPs for Irrigation](#) for additional BMP considerations.
- Refer to [S443E: BMPs for Fertilizer Application](#) and [S435E: BMPs for Pesticides and an Integrated Pest Management Program](#).

## **Applicable Structural BMPs**

- Use windbreaks or other means (e.g., pot in pot) to minimize plant blowover ([FDACS, 2014](#)).
- Cover potting areas with a permanent structure to minimize movement of loose soil. Use a temporary structure if a permanent structure is not feasible ([Haver, 2014](#)).
- Control runoff from central potting locations that have a watering station used to irrigate plants immediately after potting. Implement one of the following actions:
  - Collect runoff in a small basin and reuse the runoff.
  - Route runoff through an on-site vegetative treatment area.
  - Use a graveled area and allow runoff to infiltrate.
- Surround soil storage and compost storage areas with a berm or wattles.
- Use a synthetic (geotextile) ground cover material to stabilize disturbed areas and prevent erosion in areas where vegetative cover is not an option ([FDACS, 2014](#)).
- In areas with a large amount of foot traffic, use appropriate aggregate such as rock and gravel for stabilization ([FDACS, 2014](#)).
- Store potting substrate that contains fertilizer in a dedicated area with an impermeable base. If the storage area is not under a roof to protect it from rainfall, manage runoff by directing it to a stormwater treatment area ([FDACS, 2014](#)).

## **S450E: BMPs for Irrigation**

### **Description of Pollutant Sources**

Irrigation consists of discharges from irrigation water lines, landscape irrigation, and lawn or garden watering. Excessive watering can lead to discharges of chlorinated potable water runoff into drainage systems; it can also cause erosion; and adversely affect plant health. Improper irrigation can encourage pest problems, result in leaching of nutrients, and make a lawn completely dependent on artificial watering. Mosquito breeding habitats may form a result of excessive watering.

### **Pollutant Control Approach**

Limit the amount and location of watering to prevent runoff and discharges to drainage systems.

### **Applicable Operational BMPs**

- Irrigate with the minimum amount of water needed. Never water at rates that exceed the infiltration rate of the soil.
- Maintain all irrigation systems so that irrigation water is applied evenly and where it is needed.
- Ensure sprinkler systems do not overspray vegetated areas resulting in excess water discharging into the drainage system.
- Inspect irrigated areas for excess watering. Adjust watering times and schedules to ensure

that the appropriate amount of water is being used to minimize runoff. Consider factors such as soil structure, grade, time of year, and type of plant material in determining the proper amounts of water for a specific area.

- Inspect irrigated areas regularly for signs of erosion and/or discharge.
- Place sprinkler systems appropriately so that water is not being sprayed on impervious surfaces instead of vegetation.
- Repair broken or leaking sprinkler nozzles as soon as possible.
- Appropriately irrigate lawns based on the species planted, the available water holding capacity of the soil, and the efficiency of the irrigation system.
  - The depth from which a plant normally extracts water depends on the rooting depth of the plant. Appropriately irrigated lawn grasses normally root in the top 6 to 12 inches of soil; lawns irrigated on a daily basis often root in only the top 1 inch of soil.
- Do not irrigate plants during or immediately after fertilizer application. The longer the period between fertilizer application and irrigation, the less fertilizer runoff.
- Do not irrigate plants during or immediately after pesticide application (unless the pesticide label directs such timing).
- Reduce frequency and/or intensity of watering as appropriate for the wet season (October 1 to June 30).
- Place irrigation systems to ensure that plants receive water where they need it. For example, do not place irrigation systems downgradient of plant's root zones on hillsides.

### ***Recommended Operational BMPs***

- Add a tree bag or slow-release watering device (e.g., bucket with a perforated bottom) for watering newly installed trees when irrigation system is not present.
- Water deeply, but infrequently, so that the top 6 to 12 inches of the root zone is moist.
- Use soaker hoses or spot water with a shower-type wand when an irrigation system is not present.
  - Pulse water to enhance soil absorption, when feasible.
  - Premoisten soil to break surface tension of dry or hydrophobic soils/mulch, followed by several more passes. With this method, each pass increases soil absorption and allows more water to infiltrate prior to runoff.
- Identify trigger mechanisms for drought-stress (e.g., leaf wilt, leaf senescence, etc.) of different species and water immediately after initial signs of stress appear.
- Water during drought conditions or more often if necessary to maintain plant cover.
- Adjust irrigation frequency/intensity as appropriate after plant establishment.
- Annually inspect irrigation systems to ensure the following:

- There are no blockages of sprayer nozzles.
- Sprayer nozzles are rotating as appropriate.
- Sprayer systems are still aligned with the plant locations and root zones.
- Consult with the local water utility, conservation district, or Washington State University Extension office to help determine optimum irrigation practices.
- Do not use chemigation and fertigation in irrigation systems. This will help avoid overapplication of pesticides and fertilizers.

## **S451E: BMPs for Building, Repair, Remodeling, Painting, and Construction**

### ***Description of Pollutant Sources***

This activity applies to the following:

- Construction of buildings and other structures
- Remodeling of existing buildings and houses
- General exterior building repair work

Pollutants of concern include toxic hydrocarbons, hazardous wastes, toxic organics, suspended solids, heavy metals, pH, oils, and greases.

### ***Pollutant Control Approach***

Educate employees about the need to control site activities. Control leaks, spills, and loose material. Implement good housekeeping practices. Regularly clean up debris that can contaminate stormwater. Protect the drainage system from dirty runoff and loose particles.

### ***Applicable Operational BMPs***

- Identify, remove, and properly dispose of hazardous substances from the building before beginning repairing or remodeling activities that could expose them to stormwater. Such substances could include polychlorinated biphenyls (PCBs), asbestos, lead paint, mercury switches, and electronic waste.
- Educate employees about the need to control site activities to prevent stormwater pollution, and also train them in spill cleanup procedures.
- At all times, have available at the work site spill cleanup materials appropriate to the chemicals used on site.
- Clean up the work site at the end of each workday. Put away materials (such as solvents) indoors or cover and secure them so that unauthorized individuals will not have access to them.
- Sweep the area daily to collect loose litter, paint chips, grit, and dirt.

- Do not dump any substance on pavement, on the ground, in the storm drain, or toward the storm drain, regardless of its content, unless it is clean water only.
- Place a drop cloth, where space and access permits, before beginning wood treating activities. Use drip pans in areas where drips are likely to occur if the area cannot be protected with a drop cloth.
- Use ground or drop cloths underneath scraping and sandblasting work. Use ground cloths, buckets, or tubs anywhere that work materials are laid down.
- Clean paint brushes and other tools covered with water-based paints in sinks connected to sanitary sewers or in portable containers that can subsequently be dumped into a sanitary sewer drain.
- Clean brushes and tools covered with non-water-based finishes or other materials in a manner that enables collection of used solvents for recycling or proper disposal. Do not discharge non-water-based finishes or paints or used solvents into the sanitary sewer, or any other drain.
- Use storm drain covers, or similarly effective devices, to prevent dust, grit, washwater, or other pollutants from escaping the work area. Place the cover or containment device over the storm drain at the beginning of the work day. Collect and properly dispose of accumulated dirty runoff and solids before removing the cover or device at the end of each work day.
- Refer to [S431E: BMPs for Washing and Steam Cleaning Vehicles/Equipment/Building Structures](#) for information associated with power washing buildings.

### ***Recommended Operational BMPs***

- Lightly spray water on the work site to control dust and grit that could blow away. Do not use oils for dust control. Never spray to the point of water runoff from the site.
- Clean tools over a ground cloth or within a containment device such as a tub.

## **S452E: BMPs for Goose Waste**

### ***Description of Pollutant Sources***

Goose waste deposited near water or in water can contribute nutrients and algae growth. Goose feces may contain pathogens and contribute to the spread of diseases. Swimmers itch (schistosomiasis or cercarial dermatitis) is caused by a parasite that can be spread by goose droppings, but does not mature or reproduce in humans.

### ***Pollutant Control Approach***

To help decrease geese pollution to water sources, remove waste periodically and use deterrent management practices.

### ***Applicable Operational BMPs***

This BMP is for areas of chronic accumulation of goose waste that impact stormwater systems.

- If possible, pick up goose waste using shovels, brooms, rakes, power sweepers, and trash cans. Properly dispose of goose waste in the garbage.
- Do not blow, sweep, or wash goose waste into waterways or storm sewer systems.
- Regularly clean goose waste from areas of chronic deposition where deterrence measures are impractical.
- Do not feed wild geese or any other wild animals.
- In recreational areas post signs discouraging the feeding of geese and other wild animals.

### ***Optional Operational BMPs***

- Change the habitat from goose friendly to goose resistant. Reduce lawn areas and increase the height of shoreline vegetation (tall grass, shrubs); as geese are reluctant to walk through tall vegetation.
- Create a natural geese barrier. 20 to 100 feet of herbaceous vegetation at least 3 feet in height to discourage geese . A narrow, winding path through the plantings will allow for beach access, while preventing geese from having a direct line of sight through the planted area.
- Make bank slopes steeper than 4:1 to discourage geese by preventing a clear view of the bank top and potential predators . Or, separate the beach from the grass with a few steep steps, which makes the ascent too difficult for most geese.
- Narrow ponds to limit takeoff and landing opportunities .
- Where space is limited use one or two rows of shrub plantings combined with a fence. Fences can be made from woven wire, poultry netting, plastic netting, plastic snow fencing, monofilament line, or electrified wire. Fences should be at least 24 inches tall (3 feet may be better), firmly constructed, and installed to prevent the geese from walking around the ends. Lower openings should be no larger than 4 inches from the ground to prevent goslings from walking under or through the fence.
- Construct a grid of wire or line above the water's surface to prevent geese from flying into a pond that they have been accustomed to using. The grid should be one to two feet above the water surface, but may be taller if humans need access to the area under the grid. There should be no more than five feet of space between grid lines. To prevent geese from walking under the grid install a perimeter fence. Regularly monitor the grid for holes, trapped wildlife, and sagging.
- Canada geese are protected under federal and state law and a hunting license and open season are required to hunt them. Where lethal control of Canada geese is necessary outside of hunting seasons, it should be carried out only after the above nonlethal control techniques have proven unsuccessful and only under permits issued by the U.S. Fish and Wildlife Service. Currently, the only agency permitted for lethal removal is the U.S. Department of Agriculture's Wildlife Services. Lethal control techniques include legal hunting, shooting out of season by permit, egg destruction by permit, and euthanasia of adults by government officials.
- Scare geese away when they are around. Geese often learn quickly to ignore scare devices



that are not a real physical danger. Vary the use, timing, and location of tactics. Take advantage of geese being fearful of new objects. Examples of harassment and scare tactics:

- **Dog patrols:** When directed by a handler, dogs are the method of choice for large open areas. Results are often immediate. After an aggressive initial use (several times a day for one or two weeks), geese get tired of being harassed and will use adjacent areas instead. A dog can be tethered to a long lead (which may require relocating the dog and tether frequently to cover more area), be allowed to chase and retrieve a decoy thrown over a large flock of geese, or be periodically released to chase the birds (if this is not against leash laws).
  - **Eyespot Balloons:** Large, helium-filled balloons with large eye-like images. Tether balloons on a 20 to 40 foot monofilament line attached to a stake or heavy object. Locate balloons where they will not tangle with trees or utility lines.
  - **Flags and Streamers:** Simple flags from plastic mounted on tall poles or mylar tape to make 6-foot streamers attached to the top of 8 foot long poles. Flags and streamers work best in areas where there is steady wind.
  - **Scarecrows:** Effective in areas where geese view humans as dangerous predators. For maximum effect, the arms and legs should move in the wind, use bright colors, and large eyes. Large, blow-up toy snakes are reported to work as a type of scarecrow.
  - **Noisemakers:** Devices that make a loud bang such as propane cannons, blanks, and whistle bombs can scare geese. Making the noise as soon as geese arrive and persistence are the keys to success when using these devices. Consult noise ordinances and other permitting authorities (such as the local police department) before using.
  - **Lasers:** Relatively low-power, long-wavelength lasers provide an effective means of dispersing geese under low light conditions. The birds view the light as a physical object or predator coming toward them and generally fly away to escape. Never aim lasers in the direction of people, roads, or aircraft.
- Geese's favorite food is new shoots of grass. Low lying grass also allows easy access to the water for protection from predators. Let grass grow to six inches or taller. Stop fertilizing and watering the lawn to reduce the palatability of the lawn.
  - Minimize open sight lines for geese to less than 30 feet.
  - Plant shrubs or trees along ponds to limit takeoff and landing opportunities.

Refer to: [http://www.humanesociety.org/assets/pdfs/wild\\_neighbors/canada\\_goose\\_guide.pdf](http://www.humanesociety.org/assets/pdfs/wild_neighbors/canada_goose_guide.pdf) and <https://wdfw.wa.gov/species-habitats/species/branta-canadensis> for additional information.

*This page has been intentionally left blank for double-sided printing.*

# Appendix 8-A: Urban Land Uses and Pollution-Generating Sources

## 8.A.1 Introduction

Use this appendix to identify pollution-generating sources at various land uses (manufacturing, transportation, communication, wholesale, retail, service—based on the *North American Industry Classification System* (NAICS) ([U.S. Census Bureau, 2017](#))). Public agency activities that do not have a NAICS code are also summarized at the end of this appendix. Applicable operational source control, structural source control, and treatment Best Management Practices (BMPs) for each pollutant source can then be selected by referring to [8.2.3 Pollutant Source-Specific BMPs](#). Other land uses not included in this appendix should also consider implementing applicable BMPs for their pollutant sources. Note that potentially polluting operations may not be limited to those examples identified with NAICS codes.

## 8.A.2 Manufacturing Businesses

### Cement

**NAICS 3273XX:** Cement and Concrete Product Manufacturing

#### Description

These businesses primarily produce Portland cement, the binder used in concrete for paving, buildings, pipe, and other structural products. The three basic steps in cement manufacturing are (1) proportioning, grinding, and blending raw materials; (2) heating raw materials to produce a hard, stony substance known as clinker; and (3) combining the clinker with other materials and grinding the mixture into a fine powdery form. The raw materials include limestone, silica, alumina, iron, chalk, oyster shell marl, or shale. Waste materials from other industries are often used, such as slag, fly ash, and spent blasting sand. Raw materials are crushed, mixed, and heated in a kiln to produce the correct chemical composition. Kilns typically are coal, gas, or oil fired. The output of the kiln is a clinker that is ground to produce the final product.

The basic process may be wet or dry. In the wet process water is mixed with the raw ingredients in the initial crushing operation and in some cases, is used to wash the material prior to use. Water may also be used in the air pollution control scrubber. The most significant waste material from cement production is the kiln dust. Concrete products may also be produced at ready-mix concrete facilities. Refer to [Concrete Products](#) for a description of the Best Management Practices (BMPs) appropriate for these activities.

#### Potential Pollution-Generating Sources

Stormwater may be contaminated during the crushing, grinding, storage, and handling of kiln dust, limestone, shale, clay, coal, clinker, gypsum, anhydrite, slag, sand, and product; and at the vehicle and equipment maintenance, fueling, and cleaning areas. Total suspended solids (TSS), aluminum, iron and other heavy metals, pH, chemical oxygen demand (COD), potassium, sulfate, and oil and grease are some of the potential pollutants.

## **Chemicals Manufacturing**

**NAICS 325XXX:** Chemical Manufacturing

### **Description**

This group is engaged in the manufacture of chemicals, or products based on chemicals, such as acids, alkalis, inks, chlorine, industrial gases, pigments, chemicals used in the production of synthetic resins, fibers and plastics, synthetic rubber, soaps and cleaners, pharmaceuticals, cosmetics, paints, varnishes, resins, photographic materials, chemicals, organic chemicals, agricultural chemicals, adhesives, sealants, and ink.

### **Potential Pollution-Generating Sources**

Activities that can contaminate stormwater include bagging, blending, packaging, crushing, milling, shredding, granulation, grinding, storage, distribution, loading/unloading, and processing of materials; equipment storage; application of fertilizers; foundries; lime application; use of machinery; material handling and warehousing; cooling towers; fueling; boilers; hazardous waste treatment, storage and disposal; wastewater treatment; plant yard areas of past industrial activity; access roads and tracks; drum washing; and maintenance and repair.

Chemical businesses in the Seattle area surveyed for dangerous wastes have been found to produce waste caustic solutions, soaps, heavy metal solutions, inorganic and organic chemicals, solvents, acids, alkalis, paints, varnishes, pharmaceuticals, and inks. The potential pollutants include biochemical oxygen demand (BOD), total suspended solids (TSS), chemical oxygen demand (COD), oil and grease (O&G), pH, total phosphorus, nitrates (NO<sub>3</sub>), nitrites (NO<sub>2</sub>), total Kjeldahl nitrogen (TKN), ammonia, specific organics, and heavy metals.

## **Concrete Products**

**NAICS 3273XX:** Cement and Concrete Product Manufacturing

**NAICS 3274XX:** Lime and Gypsum Product Manufacturing

### **Description**

Businesses that manufacture ready-mix concrete, gypsum products, concrete blocks and bricks, concrete sewer or drainage pipe, septic tanks, and prestressed concrete building components. Concrete is prepared on-site and poured into molds or forms to produce the desired product. The basic ingredients of concrete are sand, gravel, Portland cement, crushed stone, clay, and reinforcing steel for some products. Admixtures, including fly ash, calcium chloride, triethanolamine, lignosulfonic acid, sulfonated hydrocarbon, fatty acid glyceride, or vinyl acetate, may be added to obtain desired characteristics such as slower or more rapid curing times.

The first stage in the manufacturing process is proportioning cement, aggregate, admixtures and water, and then transporting the product to a rotary drum, or pan mixer. The mixture is then fed into an automatic block-molding machine that rams, presses, or vibrates the mixture into its final form. The final product is then stacked on iron framework cars where it cures in 4 hours. After being mixed in a central mixer, concrete is molded in the same manner as concrete block. The concrete cures in

the forms for a number of hours. Forms are washed for reuse, and the concrete products are stored until they can be shipped.

### **Potential Pollution-Generating Sources**

Pollution-generating activities/sources include stockpiles; washing of waste concrete from trucks, forms, equipment, and the general work area; and water from the curing of concrete products. Besides the basic ingredients for making concrete products, chemicals used in the curing of concrete and the removal of forms may end up in stormwater. These chemicals can include latex sealants, bitumastic coatings, and release agents. Trucks and equipment maintained on-site may generate waste oil and solvents, and other waste materials. Potential pollutants include total suspended solids (TSS), chemical oxygen demand (COD), biochemical oxygen demand (BOD), pH, lead, iron, zinc, and oil and grease.

### ***Electrical Products***

**NAICS 33324x:** Industrial Machinery Manufacturing

**NAICS 33331x:** Commercial and Service Industry Machinery Manufacturing

**NAICS 33341x:** Ventilation, Heating, Air Conditioning, and Commercial Refrigeration Equipment Manufacturing

**NAICS 3339xx:** Other General Purpose Machinery Manufacturing

**NAICS 334xxx:** Computer and Electronic Product Manufacturing

**NAICS 335xxx:** Electrical Equipment, Appliance, And component Manufacturing

**NAICS 336xxx:** Transportation Equipment Manufacturing

**NAICS 339xxx:** Miscellaneous Manufacturing

### **Description**

A variety of products are produced including electrical transformers and switchgear, motors, generators, relays, and industrial controls; communications equipment for radio and TV stations and systems; electronic components and accessories including semiconductors; printed board circuits; electromedical and electrotherapeutic apparatus; and electrical instrumentation. Manufacturing processes include electroplating, machining, fabricating, etching, sawing, grinding, welding, and parts cleaning. Materials used include metals, ceramics, quartz, silicon, inorganic oxides, acids, alkaline solutions, arsenides, phosphides, cyanides, oils, fuels, solvents, and other chemicals.

### **Potential Pollution-Generating Sources**

Most of the actual manufacturing and processing activity at the types of facilities discussed here normally occur indoors and will not be exposed to stormwater. The types of activities where exposure to stormwater may occur consist primarily of loading and unloading activities, and the storage and handling of raw materials, by-products, final products, or waste products. A wide variety of materials are used at these facilities, including metals, acids used for chemical etching, alkaline solutions, solvents, various oils and fuels, and miscellaneous chemicals. Tanks or drums of these

materials may be exposed to stormwater during loading/ and un-loading operations, or through outdoor storage or handling.

Liquid wastes which may be exposed at least temporarily include spent solvents and acids, miscellaneous chemicals, and oily wastes. These wastes may be contaminated with a variety of heavy metals and chlorinated hydrocarbons. Used equipment, scrap metal and wire, soiled rags, and sanding materials may also be exposed to stormwater and constitute a potential source of pollutants. In addition, some facilities may have dumpsters containing nonhazardous wastes or manufacturing debris that may be exposed to stormwater.

Wastewater consists of solutions and rinses from electroplating operations, and the wastewaters from cleaning operations. Water may also be used to cool saws and grinding machines. Sludges are produced by the wastewater treatment process. Potential pollutants include total suspended solids (TSS), oil and grease, organics, pH, biochemical oxygen demand (BOD), chemical oxygen demand (COD), total Kjeldahl nitrogen, nitrate and nitrite nitrogen, copper, zinc, lead, and silver.

### ***Food and Kindred Products***

**NAICS 115114:** Postharvest Crop Activities (except Cotton Ginning)

**NAICS 311xxx:** Food Manufacturing

**NAICS 312xxx:** Beverage and Tobacco Product Manufacturing

#### **Description**

Businesses in this category include facilities manufacturing or processing foods, beverages, and related products for human consumption, and prepared feeds for animals and fowls. Facilities engaged in manufacturing cigarettes, cigars, and other tobacco products are also included. Food processing typically occurs inside buildings. Exceptions are meat packing plants where live animals may be kept outside, and fruit and vegetable plants where the raw material may be temporarily stored outside. Meat production facilities include stockyards, slaughtering, cutting and deboning, meat processing, rendering, and materials recovery. Dairy production facilities include receiving stations, clarification, separation, and pasteurization followed by culturing, churning, pressing, curing, blending, condensing, sweetening, drying, milling, and packaging. Canned frozen and preserved fruits and vegetables are typically produced by washing, cutting, blanching, and cooking followed by drying, dehydrating, and freezing.

Grain mill products are processed during washing, milling, debranning, heat treatment, screening, shaping, and vitamin and mineral supplementing. Bakery products processing includes dough mixing and shaping, cooling, and decorating. Operations at an edible oil manufacturer include refining, bleaching, hydrogenation, fractionation, emulsification, deodorization, filtration, and blending. Beverage production includes brewing, distilling, fermentation, blending, and packaging. Wine processors often crush grapes outside the process building and/or store equipment outside when not in use. Some wine producers use juice from grapes crushed elsewhere. Some vegetable and fruit processing plants use caustic solutions.

#### **Potential Pollution-Generating Sources**

The nature of the business, and the required sanitary conditions, require that raw and processed materials be protected from stormwater. As such, the contamination of stormwater from these activities is primarily from the loading and unloading of products and raw materials; spillage and leaks from tanks and containers stored outdoors; waste management practices; pest control; and improper connections to the drainage system. The following are the pollutants typically expected from this industry segment: biochemical oxygen demand (BOD), total suspended solids (TSS), oil and grease, pH, total Kjeldahl nitrogen, copper, manganese, fecal coliform bacteria, and pesticides.

## ***Glass Products***

**NAICS 32721x:** Glass and Glass Product Manufacturing

### **Description**

The glass form produced may be flat or window, safety, or container; tubing; glass wool; or fibers. The raw materials are sand mixed with a variety of oxides, such as aluminum, antimony, arsenic, lead, copper, cobalt oxide, and barium. The raw materials are mixed and heated in a furnace. Processes that vary with the intended product shape the resulting molten material. The cooled glass may be edged, ground, polished, annealed, and/or heat-treated to produce the final product. Air emissions from the manufacturing buildings are scrubbed to remove particulates.

### **Potential Pollution-Generating Sources**

Raw materials are generally stored in silos, except for crushed recycled glass and materials washed off recycled glass. Contamination of stormwater and/or ground water can be caused by raw materials lost during unloading operations, errant flue dust, equipment/vehicle maintenance, and engine fluids from mobile lifting equipment that is stored outside. The maintenance of the manufacturing equipment will produce waste lubricants and cleaning solvents. The flue dust is likely to contain heavy metals, such as arsenic, cadmium, chromium, mercury, and lead. Potential pollutants include suspended solids, oil and grease, high/low pH, and heavy metals, such as arsenic, cadmium, chromium, mercury, and lead.

## ***Industrial Machinery and Equipment, Trucks and Trailers, Aircraft, Aerospace, and Railroad***

**NAICS 333xxx:** Machinery Manufacturing

**NAICS 336xxx:** Transportation Equipment Manufacturing

### **Description**

This category includes the manufacture of a variety of equipment, including engines and turbines, farm and garden equipment, construction and mining machinery, metal working machinery, pumps, computers and office equipment, automatic vending machines, refrigeration and heating equipment, and equipment for the manufacturing industries. This group also includes many small machine shops; and the manufacturing of trucks, trailers and parts, airplanes and parts, missiles, spacecraft, and railroad equipment and instruments.

Manufacturing processes include various forms of metal working and finishing, such as electroplating, anodizing, chemical conversion coating, etching, chemical milling, cleaning, machining, grinding, polishing, sand blasting, laminating, hot dip coating, descaling, degreasing, paint stripping, painting, and the production of plastic and fiberglass parts. Raw materials include ferrous and nonferrous metals, such as aluminum, copper, iron, steel, and their alloys; paints, solvents, acids, alkalis, fuels, lubricating and cutting oils; and plastics.

### **Potential Pollution-Generating Sources**

Potential pollutant sources include fuel islands, maintenance shops, loading/unloading of materials, and outside storage of gasoline, diesel, cleaning fluids, equipment, solvents, paints, wastes, detergents, acids, other chemicals, oils, metals, and scrap materials. Air emissions from stacks and ventilation systems are potential areas for exposure of materials to rainwater.

### ***Metal Products***

**NAICS 331xxx:** Primary Metal Manufacturing

**NAICS 332xxx:** Fabricated Metal Product Manufacturing

**NAICS 337124:** Metal Household Furniture Manufacturing

**NAICS 337214:** Office Furniture (except Wood) Manufacturing

**NAICS 339xxx:** Miscellaneous Manufacturing

### **Description**

This group includes mills that produce basic metals and primary products, as well as foundries, electroplaters, and fabricators of final metal products. Basic metal production includes steel, copper, and aluminum. Mills that transform metal billets, either ferrous or nonferrous, such as aluminum, to primary metal products are included. Primary metal forms include sheets, flat bar, building components, such as columns, beams and concrete reinforcing bar, and large pipe.

Steel mills in the Pacific Northwest use recycled metal and electric furnaces. The molten steel is cast into billets or ingots that may be reformed on-site or taken to rolling mills that produce primary products. As iron and steel billets may sit outside before reforming, surface treatment to remove scale may occur prior to reforming. Foundries pour or inject molten metal into a mold to produce a shape that cannot be readily formed by other processes. The metal is first melted in a furnace. The mold is made of sand or metal die blocks that are locked together to make a complete cavity. The molten metal is ladled in and the mold is cooled. The rough product is finished by quenching, cleaning, and chemical treatment. Quenching involves immersion in a plain water bath or water with an additive.

Businesses that fabricate metal products from metal stock provide a wide range of products. The raw stock is manipulated in a variety of ways, including machining of various types, grinding, heating, shearing, deformation, cutting and welding, soldering, sand blasting, brazing, and laminating. Fabricators may first clean the metal by sand blasting, descaling, or solvent degreasing. Final finishing may involve electroplating, painting, or direct plating by fusing or vacuum metalizing.



Raw materials, in particular recycled metal, are stored outside prior to use, as are billets before reforming. The descaling process may use salt baths, sodium hydroxide, or acid (pickling).

Primary products often receive a surface coating treatment. Prior to the coating, the product surface may be prepared by acid pickling to remove scale, or alkaline cleaning to remove oils and greases. The two major classes of metallic coating operations are hot and cold coating. Zinc, tin, and aluminum coatings are applied in molten metal baths. Tin and chromium are usually applied electrolytically from plating solutions.

### **Potential Pollution-Generating Sources**

Potential pollution-generating sources include outside storage of chemicals, metal feedstock, byproducts (fluxes), finished products, fuels, lubricants, waste oil, sludge, waste solvents, dangerous wastes, piles of coal, coke, dusts, fly ash, baghouse waste, slag, dross, sludges, sand refractory rubble, and machining waste; unloading of chemical feedstock and loading of waste liquids, such as spent pickle liquor by truck or rail; material handling equipment, such as cranes, conveyors, trucks, and forklifts; particulate emissions from scrubbers, baghouses or electrostatic precipitators; fugitive emissions; maintenance shops; erosion of soil from plant yards; and floor, sink, and process wastewater drains.

## ***Paper, Pulp, and Paperboard Mills***

**NAICS 3221xx:** Pulp, Paper, and Paperboard Mills

### **Description**

Large industrial complexes in which pulp, and/or paper, and/or paperboard are produced. Products also include newsprint, bleached paper, glassine, tissue paper, vegetable parchment, and industrial papers. Raw materials include wood logs, chips, waste paper, jute, hemp, rags, cotton linters, bagasse, and esparto. The chips for pulping may be produced on site from logs, and/or imported.

The following manufacturing processes are typically used raw material preparation, pulping, bleaching, and papermaking. All of these operations use a wide variety of chemicals, including caustic soda, sodium and ammonium sulfites, chlorine, titanium oxide, starches, solvents, adhesives, biocides, hydraulic oils, lubricants, dyes, and many chemical additives.

### **Potential Pollution-Generating Sources**

The large process equipment used for pulping is not enclosed. Thus, precipitation falling over these areas may become contaminated. Maintenance of the process equipment produces waste products similar to that produced from vehicle and mobile equipment maintenance. Logs may be stored, debarked, and chipped on-site. Large quantities of chips are stored outside. Although this can be a source of pollution, the volume of stormwater flow is relatively small because the chip pile retains the majority of the precipitation. Mobile equipment such as forklifts, log stackers, and chip dozers are sources of leaks/spills of hydraulic fluids. Vehicles and equipment are fueled and maintained on-site.

## ***Paper Products***

**NAICS 3222xx:** Converted Paper Product Manufacturing

### **Description**

Included are businesses that take paper stock and produce basic paper products, such as cardboard boxes and other containers, and stationery products, such as envelopes and bond paper. Wood chips, pulp, and paper can be used as feedstock.

### **Potential Pollution-Generating Sources**

- Outside loading/unloading of solid and liquid materials
- Outside storage and handling of dangerous wastes, and other liquid and solid materials
- Maintenance and fueling activities for forklifts and other vehicles and equipment
- Outside processing activities related to paper production

## ***Petroleum Products***

**NAICS 3241xx:** Petroleum and Coal Products Manufacturing

### **Description**

The petroleum refining industry manufactures gasoline, kerosene, distillate and residual oils, lubricants and related products from crude petroleum, asphalt paving, and roofing materials. Although petroleum is the primary raw material, petroleum refineries also use other materials, such as natural gas, benzene, toluene, chemical catalysts, caustic soda, and sulfuric acid. Wastes may include filter clays, spent catalysts, sludges, and oily water.

Asphalt paving products consist of sand, gravel, and petroleum-based asphalt that serves as the binder. Raw materials include stockpiles of sand and gravel and asphalt emulsions stored in aboveground tanks.

### **Potential Pollution-Generating Sources**

- Outside processing such as distillation, fractionation, catalytic cracking, solvent extraction, coking, desulfuring, reforming, and desalting
- Petrochemical and fuel storage and handling
- Outside liquid chemical piping and tankage
- Mobile liquid handling equipment, such as tank trucks, forklifts, etc.
- Maintenance and parking of trucks and other equipment
- Waste piles, handling, and storage of asphalt emulsions, cleaning chemicals, and solvents
- Waste treatment and conveyance systems

The following are potential pollutants at oil refineries: oil and grease, biochemical oxygen demand (BOD), chemical oxygen demand (COD), total organic carbon (TOC), phenolic compounds,

polycyclic aromatic hydrocarbons (PAHs), ammonia nitrogen, total Kjeldahl nitrogen, sulfides, total suspended solids (TSS), low and high pH, and chromium (total and hexavalent).

## **Printing**

**NAICS 323xxx:** Printing and Related Support Activities

### **Description**

This industrial category includes the production of newspapers, periodicals, commercial printing materials, and businesses that do their own printing and those that perform services for the printing industry, for example bookbinding. Processes include typesetting, engraving, photoengraving, and electrotyping.

### **Potential Pollution-Generating Sources**

Various materials used in modifying the paper stock include inorganic and organic acids, resins, solvents, polyester film, developers, alcohol, vinyl lacquer, dyes, acetates, and polymers. Waste products may include waste inks and ink sludge, resins, photographic chemicals, solvents, acid and alkaline solutions, chlorides, chromium, zinc, lead, spent formaldehyde, silver, plasticizers, and used lubricating oils. As the printing operations occur indoors, the only likely points of potential contact with stormwater are the outside temporary storage of waste materials, offloading of chemicals at external unloading bays, and vehicle/equipment repair and maintenance. Pollutants of concern include total suspended solids (TSS), pH, heavy metals, oil and grease, and chemical oxygen demand (COD).

## **Rubber and Plastic Products**

**NAICS 3252xx:** Resin, Synthetic Rubber, and Artificial and Synthetic Fibers and Filaments Manufacturing

**NAICS 326xxx:** Plastics and Rubber Products Manufacturing

### **Description**

Products in this category include: rubber tires, hoses, belts, gaskets, seals; and plastic sheet, film, tubes, pipes, bottles, cups, ice chests, packaging materials, and plumbing fixtures. The rubber and plastics industries use a variety of processes ranging from polymerization to extrusion, using natural or synthetic raw materials. These industries use natural or synthetic rubber, plastics components, pigments, adhesives, resins, acids, caustic soda, zinc, paints, fillers, and curing agents.

### **Potential Pollution-Generating Sources**

Pollution-generating sources/activities include storage of liquids, other raw materials or by-products, scrap materials, oils, solvents, inks and paints; unloading of liquid materials from trucks or rail cars; washing of equipment; waste oil and solvents produced by cleaning manufacturing equipment; used equipment that could drip oil and residual process materials; and maintenance shops.

Potential pollutants are biochemical oxygen demand (BOD), chemical oxygen demand (COD), nitrate and nitrite nitrogen, total Kjeldahl nitrogen (TKN), total phosphorus, total suspended solids (TSS), pH, trichloroethane, methylene chloride, toluene, zinc, and oil and grease.

## ***Ship and Boat Building and Repair Yards***

**NAICS 3366xx:** Ship and Boat Building

### **Description**

Businesses that build or repair ships and boats. Typical activities include hull scraping, sandblasting, finishing, metal fabrication, electrical repairs, engine overhaul, welding, fiberglass repairs, hydroblasting, and steam cleaning.

### **Potential Pollution-Generating Sources**

Outside boatyard activities that can be sources of stormwater pollution include pressure washing, surface preparation, paint removal, sanding, painting, engine/vessel maintenance and repairs, and material handling and storage.

Secondary sources of stormwater contaminants are cooling water, pump testing, gray water, sanitary waste, washing down the work area, and engine bilge water. Engine room bilge water and oily wastes are typically collected and disposed of through a licensed contracted disposal company. Two primary sources of copper are leaching of copper from antifouling paint and wastes from hull maintenance. Wastes generated by boatyard activities include spent abrasive grits, spent solvent, spent oils, fuel, ethylene glycol, washwater, paint overspray, various cleaners/detergents and anticorrosive compounds, paint chips, scrap metal, welding rods, wood, plastic, resins, glass fibers, dust, and miscellaneous trash, such as paper and glass.

The Washington State Department of Ecology, local shipyards, and METRO have sampled pressure wash wastewater. The effluent quality has been variable and frequently exceeds water quality criteria for copper, lead, tin, and zinc. From monitoring results received to date, metal concentrations typically range from 5 to 10 milligrams per liter (mg/L), but have gone as high as 190 mg/L copper with an average 55 mg/L copper.

## ***Wood***

**NAICS 321xxx (except 321114):** Wood Product Manufacturing (except Wood Preservation)

### **Description**

This group includes sawmills and all businesses that make wood products using cut wood, with the exception of wood treatment businesses. Wood treatment and log storage/sorting yards are covered in other sections of this chapter. Included in this group are planing mills, millworks, and businesses that make wooden containers and prefab building components, mobile homes, and glued-wood products, including laminated beams, office and home furniture, partitions, and cabinets. All businesses employ cutting equipment whose by-products are chips and sawdust. Finishing is conducted in many operations.

### **Potential Pollution-Generating Sources**

Businesses may have operations that use paints, solvents, wax emulsions, melamine formaldehyde and other thermosetting resins, and produce waste paints and paint thinners, turpentine, shellac, varnishes and other waste liquids. Outside storage, trucking, and handling of these materials can also be pollutant sources.

Potential pollutants are biochemical oxygen demand (BOD), chemical oxygen demand (COD), nitrate and nitrite nitrogen, total Kjeldahl nitrogen (TKN), total phosphorus, total suspended solids (TSS), arsenic, copper, total phenols, oil & grease, and pH.

## ***Wood Treatment***

**NAICS 321114:** Wood Preservation

### **Description**

This group includes both antistaining and wood preserving. The wood stock must be brought to the proper moisture content prior to treatment, which is achieved by either air-drying or kiln drying. Some wood trimming may occur. After treatment, the lumber is typically stored outside. Forklifts are used to move both the raw and finished product. Wood treatment consists of a pressure process using the chemicals described below. Antistaining treatment is conducted using dip tanks or by spraying. Wood preservatives include creosote, creosote/coal tar, pentachlorophenol, copper naphthenate or inorganic arsenicals such as chromated copper arsenate dissolved in water. The use of pentachlorophenol is declining in the Puget Sound region.

### **Potential Pollution-Generating Sources**

Potential pollution-generating sources/activities include the retort area, handling of the treated wood, outside storage of treated materials/products, equipment/vehicle storage and maintenance, and the unloading, handling, and use of the preservative chemicals. Based on the U.S. Environmental Protection Agency's multi-sector general permit for industrial activities (U.S. EPA, 1995) the following stormwater contaminants have been reported: chemical oxygen demand (COD), total suspended solids (TSS), biochemical oxygen demand (BOD), and the specific pesticide(s) used for the wood preservation.

## ***Other Manufacturing Businesses***

**NAICS 313xxx:** Textile Mills

**NAICS 314xxx:** Textile Product Mills

**NAICS 315xxx:** Apparel Manufacturing

**NAICS 316xxx:** Leather and Allied Product Manufacturing

**NAICS 3253xx:** Pesticide, Fertilizer, and Other Agricultural Chemical Manufacturing

**NAICS 327xxx:** Nonmetallic Mineral Product Manufacturing

### **Description**

Includes manufacturing of textiles and apparel, agricultural fertilizers, leather products, clay products such as bricks and pottery, bathroom fixtures, and nonmetallic mineral products.

### **Potential Pollution-Generating Sources**

Pollution-generating sources at facilities in these categories include fueling, loading and unloading, material storage and handling (especially fertilizers), and vehicle and equipment cleaning and maintenance. Potential pollutants include total suspended solids (TSS), biochemical oxygen demand (BOD), chemical oxygen demand (COD), oil and grease, heavy metals, and fertilizer components including nitrates, nitrites, ammonia nitrogen, total Kjeldahl nitrogen (TKN), and phosphorus compounds.

## **8.A.3 Transportation and Communication**

### ***Airfields and Aircraft Maintenance***

**NAICS 481xxx:** Air Transportation

**NAICS 4881xx:** Support Activities for Air Transportation

### **Description**

Industrial activities include vehicle and equipment fueling, maintenance and cleaning, and aircraft/runway deicing.

### **Potential Pollution-Generating Sources**

Fueling is accomplished by tank trucks at the aircraft and is a source of spills. Dripping of fuel and engine fluids from the aircraft and at vehicle/equipment maintenance/cleaning areas, and application of deicing materials to the aircraft and the runways are potential sources of stormwater contamination. Aircraft maintenance and cleaning produces a wide variety of waste products, similar to those found with any vehicle or equipment maintenance, including used oil and cleaning solvents, paints, oil filters, soiled rags, and soapy wastewater. Deicing chemicals used on aircraft and/or runways include ethylene and propylene glycol and urea. Other chemicals currently considered for ice control are sodium and potassium acetates, isopropyl alcohol, and sodium fluoride. Pollutant constituents include oil and grease, total suspended solids (TSS), biochemical oxygen demand (BOD), chemical oxygen demand (COD), total Kjeldahl nitrogen, pH, and specific deicing components, such as glycol and urea.

### ***Fleet Vehicle Yards***

**NAICS 484xxx:** Truck Transportation

**NAICS 485xxx:** Transit and Ground Passenger Transportation

**NAICS 4871xx:** Scenic and Sightseeing Transportation, Land

**NAICS 4884xx:** Support Activities for Road Transportation

**NAICS 492xxx:** Couriers and Messengers

**NAICS 5321xx:** Automotive Equipment Rental and Leasing

## **NAICS 621910: Ambulance Services**

### **Description**

Includes all businesses that own, operate, and maintain or repair large vehicle fleets, including cars, buses, trucks and taxis, as well as the renting or leasing of cars, trucks, and trailers.

### **Potential Pollution-Generating Sources**

1. Spills/leaks of fuels, used oils, oil filters, antifreeze, solvents, brake fluid, and batteries, sulfuric acid, battery acid sludge, and leaching from empty contaminated containers and soiled rags
2. Leaking underground storage tanks that can cause ground water contamination and is a safety hazard
3. Dirt, oils, and greases from outside steam cleaning and vehicle washing
4. Dripping of liquids from parked vehicles
5. Solid and liquid wastes (noted above) that are not properly stored while awaiting disposal or recycling
6. Loading and unloading area

Potential pollutants from this section may include BOD, heavy metals, oil & grease, TSS, organics, and pH.

## ***Railroads***

**NAICS 482xxx:** Rail Transportation

**NAICS 4882xx:** Support Activities for Rail Transportation

### **Description**

Railroad activities are spread over a large geographic area: along railroad lines, in switching yards, and in maintenance yards. Railroad activity occurs on both property owned or leased by the railroad and at the loading or unloading facilities of its customers. The use of Best Management Practices (BMPs) at commercial or public loading and unloading areas is the responsibility of the particular property owner.

### **Potential Pollution-Generating Sources**

The following are potential sources of pollutants: dripping of vehicle fluids onto the road bed, leaching of wood preservatives from the railroad ties, human waste disposal, litter, locomotive sanding areas, locomotive/railcar/equipment cleaning areas, fueling areas, outside material storage areas, the erosion and loss of soil particles from the bed, and herbicides used for vegetation management.

Maintenance activities include maintenance shops for vehicles and equipment, track maintenance, and ditch cleaning. In addition to the railroad stock, the maintenance shops service highway vehicles

and other types of equipment. Waste materials can include waste oil, solvents, degreasers, antifreeze, radiator flush, acid solutions, brake fluids, soiled rags, oil filters, sulfuric acid and battery sludge, and machine chips with residual machining oil and any toxic fluids or solids lost during transit. The following are potential pollutants at rail yards: oil and grease, total suspended solids (TSS), biochemical oxygen demand (BOD), organics, pesticides, and heavy metals.

## ***Warehouses and Mini-Warehouses***

**NAICS 493xxx:** Warehousing and Storage

### **Description**

Businesses that store goods in buildings and other structures.

### **Potential Pollution-Generating Sources**

The following are potential pollutant sources from warehousing operations: loading and unloading areas, outside storage of materials and equipment, and fueling and maintenance areas. Potential pollutants include oil and grease and total suspended solids (TSS).

## ***Other Transportation and Communication***

**NAICS 2211xx:** Electric Power Generation, Transmission, and Distribution

**NAICS 515xxx:** Broadcasting (except Internet)

**NAICS 517xxx:** Telecommunications

**NAICS 518xxx:** Data Processing, Hosting, and Related Services

**NAICS 519xxx:** Other Information Services

**NAICS 5615xx:** Travel Arrangement and Reservation Services

### **Description**

This group includes travel agencies, communication services such as television and radio stations, cable companies, and electric and gas services. It does not include railroads, airplane transport services, airlines, pipeline companies, and airfields.

### **Potential Pollution-Generating Sources**

Gas and electric services are likely to own vehicles that are washed, fueled, and maintained on-site. Communication service companies can generate used oils and dangerous wastes. The potential pollutants are oil and grease, total suspended solids (TSS), biochemical oxygen demand (BOD), and heavy metals.

## **8.A.4 Retail and Wholesale Businesses**

### ***Gas Stations***

**NAICS 447xxx:** Gasoline Stations



Refer to [S409E: BMPs for Fueling at Dedicated Stations](#) to select the applicable BMPs.

### ***Recyclers and Scrap Yards***

**NAICS 423140:** Motor Vehicle Parts (Used) Merchant Wholesalers

**NAICS 423930:** Recyclable Material Merchant Wholesalers

Refer to [S423E: BMPs for Recyclers and Scrap Yards](#).

### ***Commercial Composting***

**NAICS 325314:** Fertilizer (Mixing Only) Manufacturing

#### **Description**

This typically applies to businesses that have numerous compost piles that require large open areas to break down the wastes. Composting can contribute nutrients, organics, fecal coliform bacteria, low pH, color, and suspended solids to stormwater runoff.

#### **Potential Pollution-Generating Sources**

The compost must be contained, but may be a cause for concern during loading and unloading. Compost can have high levels of nutrients, organics, coliform bacteria, low pH, color concerns and suspended solids. Composting requires heavy equipment such as trucks and loaders. The equipment can generate oil and grease.

### ***Restaurants/Fast Food***

**NAICS 711110:** Theater Companies and Dinner Theaters

**NAICS 722xxx:** Food Services and Drinking Places

#### **Description**

Businesses that provide food service to the general public, including drive-through facilities.

#### **Potential Pollution-Generating Sources**

Potential pollutant sources include high-use customer parking lots and garbage dumpsters. The cleaning of roofs and other outside areas of restaurant and cooking vent filters in the parking lot can cause cooking grease to be discharged to the storm drains. The discharge of washwater or grease to storm drains or receiving water is not allowed.

### ***Retail/General Merchandise***

**NAICS 442xxx:** Furniture and Home Furnishings Stores

**NAICS 443xxx:** Electronics and Appliance Stores

**NAICS 444xxx:** Building Material and Garden Equipment And Supplies Dealers

**NAICS 445xxx:** Food and Beverage Stores

**NAICS 446xxx:** Health and Personal Care Stores

**NAICS 447xxx:** Gasoline Stations

**NAICS 448xxx:** Clothing and Clothing Accessories Stores

**NAICS 451xxx:** Sporting Goods, Hobby, Musical Instrument, and Book Stores

**NAICS 452xxx:** General Merchandise Stores

**NAICS 453xxx:** Miscellaneous Store Retailers

**NAICS 454xxx:** Nonstore Retailers

### **Description**

This group includes general merchandising stores, such as department stores, shopping malls, variety stores, 24-hour convenience stores, and general retail stores that focus on a few product types, such as clothing and shoes. It also includes furniture and appliance stores.

### **Potential Pollution-Generating Sources**

Of particular concern are the high-use parking lots of shopping malls and 24-hour convenience stores. Furniture and appliance stores may provide repair services in which dangerous wastes may be produced.

## ***Retail/Wholesale Vehicle and Equipment Dealers***

**NAICS 423110:** Automobile and Other Motor Vehicle Merchant Wholesalers

**NAICS 4238xx:** Machinery, Equipment, and Supplies Merchant Wholesalers

**NAICS 441xxx:** Motor Vehicle and Parts Dealers

**NAICS 453930:** Manufactured (Mobile) Home Dealers

**NAICS 5321xx:** Automotive Equipment Rental and Leasing

**NAICS 5324xx:** Commercial & Industrial Machinery & Equipment Rental & Leasing

### **Description**

This group includes all retail and wholesale businesses that sell, rent, or lease cars, trucks, boats, trailers, mobile homes, motorcycles, and recreational vehicles. It includes both new and used vehicle dealers. It also includes sellers of heavy equipment for construction, farming, and industry. With the exception of motorcycle dealers, these businesses have large parking lots. Most retail dealers that sell new vehicles and large equipment also provide repair and maintenance services.

### **Potential Pollution-Generating Sources**

Oil and other materials that have dripped from parked vehicles can contaminate stormwater at high-use parking areas. Vehicles are washed regularly, generating vehicle grime and detergent pollutants. The stormwater or washwater runoff will contain oils and various organics, metals, and

phosphorus. Repair and maintenance services generate a variety of waste liquids and solids, including used oils and engine fluids, solvents, waste paint, soiled rags, and dirty used engine parts. Many of these materials are dangerous wastes.

### ***Retail/Wholesale Nurseries and Building Materials***

**NAICS 4233xx:** Lumber and Other Construction Materials Merchant Wholesalers

**NAICS 4237xx:** Hardware and Plumbing and Heating Equipment and Supplies Merchant Wholesalers

**NAICS 4238xx:** Machinery, Equipment, and Supplies Merchant Wholesalers

**NAICS 424930:** Flower, Nursery Stock, & Florists' Supplies Merchant Wholesalers

**NAICS 444xxx:** Building Equipment and Garden Equipment and Supplies Dealers

#### **Description**

These businesses are placed in a separate group because they are likely to store much of their merchandise outside of the main building. They include nurseries and businesses that sell building and construction materials and equipment, paint (5198 and 5230), and hardware.

#### **Potential Pollution-Generating Sources**

Some businesses may have small fueling capabilities for forklifts and may also maintain and repair their vehicles and equipment. Some businesses may have unpaved areas, with the potential to contaminate stormwater by leaching of nutrients, pesticides, and herbicides. Businesses in this group surveyed in the Puget Sound area for dangerous wastes were found to produce waste solvents, paints, and used oil. Stormwater runoff from exposed storage areas can contain suspended solids; oil and grease from vehicles, forklifts and high-use customer parking lots; and other pollutants. Runoff from nurseries may contain nutrients, pesticides, and/or herbicides.

### ***Retail/Wholesale Chemicals and Petroleum***

**NAICS 4246xx:** Chemical and Allied Products Merchant Wholesalers

**NAICS 4247xx:** Petroleum and Petroleum Products Merchant Wholesalers

**NAICS 447xxx:** Gasoline Stations

**NAICS 454310:** Fuel Dealers

#### **Description**

These businesses sell plastic materials, chemicals and related products. This group also includes the bulk storage and selling of petroleum products, such as diesel oil and automotive fuels.

#### **Potential Pollution-Generating Sources**

The general areas of concern are the spillage of chemicals or petroleum during loading and unloading, and the washing and maintenance of tanker trucks and other vehicles. Also, the fire code

requires that vegetation be controlled within a tank farm to avoid a fire hazard. Herbicides are typically used. The concentration of oil in untreated stormwater is known to exceed the water quality effluent guideline for oil and grease. Runoff is also likely to contain significant concentrations of benzene, phenol, chloroform, lead, and zinc.

### ***Retail/Wholesale Foods and Beverages***

**NAICS 4244xx:** Grocery and Related Product Merchant Wholesalers

**NAICS 4248xx:** Beer, Wine, & Distilled Alcoholic Beverage Merchant Wholesalers

**NAICS 445xxx:** Food and Beverage Stores

**NAICS 447110:** Gasoline Stations with Convenience Stores

**NAICS 4523xx:** General Merchandise Stores, including Warehouse Clubs and Supercenters

**NAICS 4542xx:** Vending Machine Operators

**NAICS 454390:** Other Direct Selling Establishments

#### **Description**

These businesses provide retail food stores, including general groceries, with fish and seafood, meats and meat products, dairy products, poultry, soft drinks, and alcoholic beverages.

#### **Potential Pollution-Generating Sources**

Vehicles may be fueled, washed and maintained at the business. Spillage of food and beverages may occur. Waste food and broken contaminated glass may be temporarily stored in containers located outside. High-use customer parking lots may be sources of oil and other contaminants.

### ***Other Retail/Wholesale Businesses***

**NAICS 423xxx:** Merchant Wholesalers, Durable Goods

**NAICS 424xxx:** Merchant Wholesalers, Nondurable Goods

**NAICS 425xxx:** Wholesale Electronic Markets and Agents and Brokers

**NAICS 441xxx:** Motor Vehicle and Parts Dealers

**NAICS 442xxx:** Furniture and Home Furnishing Stores

**NAICS 443xxx:** Electronic and Appliance Stores

**NAICS 444xxx:** Building Material and Garden Equipment and Supplies Dealers

**NAICS 446xxx:** Health and Personal Care Stores

**NAICS 448xxx:** Clothing and Clothing Accessories Stores

**NAICS 451xxx:** Sporting Goods, Hobby, Musical Instrument, and Book Stores

**NAICS 452xxx:** General Merchandise Stores

## **NAICS 453xxx: Miscellaneous Store Retailers**

### **Description**

Businesses in this group include sellers of vehicle parts, tires, furniture and home furnishings, photographic and office equipment, electrical goods, sporting goods and toys, paper products, drugs, and apparel.

### **Potential Pollution-Generating Sources**

Pollutant sources include high-use parking lots and delivery vehicles that may be fueled, washed, and maintained on premises.

## **8.A.5 Service Businesses**

### ***Animal Care Services***

**NAICS 1152xx:** Support Activities for Animal Production

**NAICS 45391x:** Pet and Pet Supplies Stores

**NAICS 54194x:** Veterinary Services

**NAICS 711212:** Racetracks

**NAICS 71329x:** Other Gambling Industries

**NAICS 81291x:** Pet care (except Veterinary) Services

### **Description**

This group includes racetracks, kennels, fenced pens, veterinary clinics, and businesses that provide boarding services for animals, including horses, dogs, and cats.

### **Potential Pollution-Generating Sources**

The primary sources of pollution include animal manure, washwaters, waste products from animal treatment, runoff from pastures where larger livestock are allowed to roam, and vehicle maintenance and repair shops. Pastures may border streams and direct access to the stream may occur. Both surface water and ground water may be contaminated. Potential stormwater contaminants include fecal coliform bacteria, oil and grease, total suspended solids (TSS), biochemical oxygen demand (BOD), and nutrients.

### ***Commercial Car and Truck Washes***

**NAICS 48849x:** Other Support Activities for Road Transportation

**NAICS 488999:** All Other support Activities for Transportation

**NAICS 811192:** Car Washes

### **Description**

Facilities include automatic systems found at individual businesses or at gas stations and 24-hour convenience stores, as well as self-service. There are three main types: tunnels, rollovers, and handheld wands. The tunnel wash, the largest, is housed in a long building through which the vehicle is pulled. At a rollover wash, the vehicle remains stationary while the equipment passes over. Wands are used at self-serve car washes. Some car washing businesses also sell gasoline.

### **Potential Pollution-Generating Sources**

Wash wastewater may contain detergents and waxes. Wastewater should be discharged to sanitary sewers. In self-service operations a drain is located inside each car bay. Although these businesses discharge the wastewater to the sanitary sewer, some washwater can find its way to the storm drain, particularly with the rollover and wand systems. Rollover systems often do not have air-drying. Consequently, as it leaves the enclosure the car sheds water to the pavement. With the self-service system, washwater with detergents can spray outside the building and flow to the storm drain. Users of self-serve operations may also clean engines and change oil, dumping the used oil into the storm drain. Potential pollutants include oil and grease, detergents, soaps, biochemical oxygen demand (BOD), and total suspended solids (TSS).

### ***Equipment Repair***

**NAICS 532xxx:** Rental and Leasing Services

**NAICS 8112xx:** Electronic and Precision Equipment Repair and Maintenance

**NAICS 8113xx:** Commercial and Industrial Machinery and Equipment (except Automotive and Electronic) Repair and Maintenance

**NAICS 8114xx:** Personal and Household Goods Repair and Maintenance

### **Description**

This group includes several businesses that specialize in repairing different equipment including communications equipment, radios, televisions, household appliances, and refrigeration systems. Also included are businesses that rent or lease heavy construction equipment, because miscellaneous repair and maintenance may occur on-site.

### **Potential Pollution-Generating Sources**

Potential pollutant sources include storage and handling of fuels, waste oils and solvents, and loading/unloading areas. Potential pollutants include oil and grease, low/high pH, and suspended solids.

### ***Laundries and Other Cleaning Services***

**NAICS 5612xx:** Facilities Support Services

**NAICS 56174x:** Carpet and Upholstery Cleaning Services

**NAICS 8123xx:** Drycleaning and Laundry Services

### **Description**

This category includes all types of cleaning services, such as laundries, linen suppliers, diaper services, coin-operated laundries and dry cleaners, and carpet and upholstery services. Wet washing may involve the use of acids, bleaches, and/or multiple organic solvents. Dry cleaners use an organic-based solvent, although small amounts of water and detergent are sometimes used. Solvents may be recovered and filtered for further use. Carpets and upholstery may be cleaned with dry materials, hot water extraction process, or in-plant processes using solvents followed by a detergent wash.

### **Potential Pollution-Generating Sources**

Wash liquids are discharged to sanitary sewers. Stormwater pollutant sources include loading and unloading of liquid materials, particularly at large commercial operations, disposal of spent solvents and solvent cans, high-use customer parking lots, and outside storage and handling of solvents and waste materials. Potential stormwater contaminants include oil and grease, chlorinated and other solvents, soaps and detergents, low/high pH, and suspended solids.

## ***Marinas and Boat Clubs***

**NAICS 713930:** Marinas

### **Description**

Marinas and yacht clubs provide moorage for recreational boats. Marinas may also provide fueling and maintenance services. Other activities include cleaning and painting of boat surfaces, minor boat repair, and pumping of bilges and sanitary holding tanks. Not all marinas have a system to receive pumped bilge water.

### **Potential Pollution-Generating Sources**

Both solid and liquid wastes are produced as well as stormwater runoff from high-use customer parking lots. Waste materials include sewage and bilge water. Maintenance by the tenants will produce used oils, oil filters, solvents, waste paints and varnishes, used batteries, and empty contaminated containers and soiled rags. Potential stormwater contaminants include oil and grease, suspended solids, heavy metals, and low/high pH.

## ***Golf and Country Clubs***

**NAICS 713910:** Golf Courses and Country Clubs

### **Description**

Public and private golf courses and parks are included.

### **Potential Pollution-Generating Sources**

Maintenance of grassed areas and landscaped vegetation has historically required the use of fertilizers and pesticides. Golf courses contain small lakes that are sometimes treated with algaecides and/or mosquito larvicides. The fertilizer and pesticide application process can lead to inadvertent contamination of nearby receiving waters by overuse, misapplication, or the occurrence

of storms shortly after application. Heavy watering of surface greens in golf courses may cause pesticides or fertilizers to migrate to receiving waters and shallow ground water resources. The use of pesticides and fertilizers generates waste containers. Equipment must be cleaned and maintained.

### ***Miscellaneous Services***

**NAICS 54192x:** Photographic Services

**NAICS 5617xx:** Services to Buildings and Dwellings

**NAICS 562xxx:** Waste Management and Remediation Services

**NAICS 712xxx:** Museums, Historical Sites, And Similar Institutions

**NAICS 713xxx:** Amusement, Gambling, and Recreation Industries

**NAICS 8122xx:** Death Care Services

**NAICS 8129xx:** Other Personal Services

### **Description**

This group includes photographic studios, commercial photography, funeral services, amusement parks, furniture and upholstery repair, pest control services, and other professional offices.

### **Potential Pollution-Generating Sources**

Pollutants from these activities may include pesticides, waste solvents, heavy metals, pH, suspended solids, soaps and detergents, and oil and grease.

### ***Professional Services***

**NAICS 52xxxx:** Finance and Insurance

**NAICS 54xxxx:** Professional, Scientific, and Technical Services

**NAICS 55xxxx:** Management of Companies and Enterprises

**NAICS 561xxx:** Administrative and Support Services

**NAICS 61xxxx:** Education Services

**NAICS 62xxxx:** Health Care and Social Assistance

**NAICS 71xxxx:** Arts, Entertainment, and Recreation

**NAICS 72xxxx:** Accommodation and Food Services

**NAICS 8121xx:** Personal Care Services

**NAICS 8129xx:** Other Personal Services

**NAICS 813xxx:** Religious, Grantmaking, Civic, Professional, & Similar Organization



## **Description**

The remaining service businesses include theaters, hotels/motels, finance, banking, hospitals, medical/dental laboratories, medical services, nursing homes, schools/universities, and legal, financial, and engineering services.

Stormwater from parking lots will contain undesirable concentrations of oil and grease, suspended particulates, and metals, such as lead, cadmium, and zinc. Dangerous wastes might be generated at hospitals, nursing homes, and other medical services.

## **Potential Pollution-Generating Sources**

Leaks and spills of materials from the following businesses can be sources of stormwater pollutants:

- Building maintenance produces wash and rinse solutions, oils, and solvents.
- Pest control produces rinse water with residual pesticides from washing application equipment and empty containers.
- Outdoor advertising produces photographic chemicals, inks, waste paints, and organic paint sludges containing metals.
- Funeral services produce formalin, formaldehyde, and ammonia.
- Upholstery and furniture repair businesses produce oil, stripping compounds, wood preservatives, and solvents.

## **Other Potential Pollution-Generating Sources**

The primary concern is runoff from high-use parking areas, maintenance shops, and storage and handling of dangerous wastes.

## ***Vehicle Maintenance and Repair***

**NAICS 8111xx:** Automotive Repair and Maintenance

**NAICS 8113xx:** Commercial and Industrial Machinery and Equipment (except Automotive and Electronic) Repair and Maintenance

## **Description**

This category includes businesses that paint, repair and maintain automobiles, motorcycles, trucks, and buses; and battery, radiator, muffler, lubrication, tune-up and tire shops, excluding those businesses listed elsewhere in the Stormwater Management Manual for Eastern Washington.

## **Potential Pollution-Generating Sources**

Pollutant sources include storage and handling of vehicles, solvents, cleaning chemicals, waste materials, vehicle liquids, batteries, and washing and steam cleaning of vehicles, parts, and equipment. Potential pollutants include waste oil, solvents, degreasers, antifreeze, radiator flush,

acid solutions with chromium, zinc, copper, lead and cadmium, brake fluid, soiled rags, oil filters, sulfuric acid and battery sludge, and machine chips in residual machining oil.

### ***Multifamily Residences***

**NAICS 53111x:** Lessors of Residential Buildings and Dwellings

**NAICS 531311:** Residential Property Managers

**NAICS 7213xx:** Rooming and Boarding Houses, Dormitories, and Workers' Camps

#### **Description**

Multifamily residential buildings such as apartments and condominiums. The activities of concern are vehicle parking, vehicle washing and oil changing, minor repairs, and temporary storage of garbage.

#### **Potential Pollution-Generating Sources**

Stormwater contamination can occur at vehicle parking lots and from washing of vehicles. Runoff from parking lots may contain undesirable concentrations of oil and grease, suspended particulates, and metals such as lead, cadmium, and zinc.

### ***Construction Businesses***

**NAICS 23xxxx:** Construction

**NAICS 5617xx:** Services to Buildings and Dwellings

**NAICS 562xxx:** Waste Management and Remediation Services

#### **Description**

This category includes builders of homes, commercial and industrial buildings, and heavy equipment, as well as plumbing, painting and paper hanging, carpentry, electrical, roofing and sheet metal, wrecking and demolition, stonework, drywall, and masonry contractors. It does not include construction sites.

#### **Potential Pollution-Generating Sources**

Potential pollutant sources include leaks/spills of used oils, solvents, paints, batteries, acids, strong acid/alkaline wastes, paint/varnish removers, tars, soaps, coatings, asbestos, lubricants, antifreeze compounds, litter; and fuels at the headquarters, operation, staging, and maintenance/repair locations of the businesses.

Demolition contractors may store reclaimed material before resale. Roofing contractors generate residual tars and sealing compounds, spent solvents, kerosene, and soap cleaners, as well as nonhazardous waste roofing materials. Sheet metal contractors produce small quantities of acids and solvent cleaners, such as kerosene, metal shavings, adhesive residues and enamel coatings, and asbestos residues that have been removed from buildings. Asphalt paving contractors are likely to store application equipment, such as dump trucks, pavers, tack coat tankers, and pavement rollers at their businesses. Stormwater passing through this equipment may be contaminated by the

petroleum residuals. Potential pollutants include oil and grease, suspended solids, biochemical oxygen demand (BOD), heavy metals, pH, chemical oxygen demand (COD), and organic compounds.

## **8.A.6 Public Agency Activities**

Local, state, and federal governments conduct many of the pollution-generating activities conducted at business facilities. Local jurisdictions include cities and counties and also single-purpose entities such as fire, sewer, and water districts.

### ***Public Facilities and Streets***

#### **Description**

Included in this group are public buildings. Also included are maintenance (deicing), and repair of streets and roads.

#### **Potential Pollution-Generating Sources**

Wastes generated include deicing and anti-icing compounds, solvents, paint, acid and alkaline wastes, paint and varnish removers, and debris. Large amounts of scrap materials are also produced throughout the course of construction and street repair. Potential pollutants include suspended solids, oil and grease, and low/high pH.

### ***Maintenance of Open Public Space Areas***

#### **Description**

The maintenance of large open spaces that are covered by expanses of grass and landscaped vegetation. Examples are zoos and public cemeteries. Golf courses and parks are also covered under Golf and Country Clubs: NAICS 713910.

#### **Potential Pollution-Generating Sources**

Maintenance of grassed areas and landscaped vegetation has historically required the use of fertilizers and pesticides. Golf courses contain small lakes that are sometimes treated with algaecides and/or mosquito larvicides. The application of pesticides can lead to inadvertent contamination of nearby receiving waters by overuse, misapplication, or the occurrence of storms shortly after application. Heavy watering of surface greens in golf courses may cause pesticides or fertilizers to migrate to receiving water and shallow ground water resources. The application of pesticides and fertilizers generates waste containers. Equipment must be cleaned and maintained. Maintenance shops where the equipment is maintained must comply with the Best Management Practices (BMPs) specified in [S414E: BMPs for Maintenance and Repair of Vehicles and Equipment](#).

### ***Maintenance of Public Stormwater Facilities***

#### **Description**

Facilities include roadside catch basins on arterials and within residential areas, conveyance pipes, detention BMPs, such as ponds and vaults, oil and water separators, biofiltration swales, filter strips, settling basins, infiltration systems, and all other types of stormwater treatment systems.

### **Potential Pollution-Generating Sources**

Research has shown that roadside catch basins can remove from 5% to 15% of the pollutants present in stormwater. However, to be effective, they must be cleaned. Research has indicated that once catch basins are about 60% full of sediment, they cease removing sediments. Generally in urban areas, catch basins become 60% full within 6 to 12 months.

Water and solids produced during the cleaning of runoff treatment BMPs, including oil and water separators, can adversely affect the quality of both surface water and ground water if disposed of improperly. The Washington State Department of Ecology has documented water quality violations and fish kills due to improper disposal of decant water (water that is removed) and catch basin sediments from maintenance activities. Disposal of decant water and solids shall be conducted in accordance with local, state, and federal requirements.

Historically, decant water from trucks has been placed back in the storm drain. Solids have been disposed of in permitted landfills and in unpermitted vacant land including wetlands. Research has shown that these residuals contain pollutants at concentrations that exceed water quality criteria. For example, limited sampling by King County and the Washington State Department of Transportation of sediments removed from catch basins in residential and commercial areas has found the concentrations of petroleum hydrocarbons to frequently exceed 200 milligrams (mg)/gram. Above this concentration, regulations require disposal at a lined landfill.

## ***Water and Sewer Districts and Departments***

### **Description**

The maintenance of water and sewer systems can produce residual materials that, if not properly handled, can cause short-term environmental impacts in adjacent surface and/or ground waters. With the exception of a few simple processes, both water and sewage treatment produce residual sludge that must be disposed of properly. However, this activity is controlled by other Washington State Department of Ecology regulatory programs and is not discussed in the Stormwater Management Manual for Eastern Washington. Larger water and sewer districts or departments may service their own vehicles.

### **Potential Pollution-Generating Sources**

Maintenance operations of concern include the cleaning of sanitary sewers, water lines, and water reservoirs; general activities around treatment plants, disposal of sludge; and the temporary shutdown of pump stations for either normal maintenance or emergencies. During the maintenance of water transmission lines and reservoirs, water district/departments must dispose of wastewater, both when the line or reservoir is initially emptied and when it is cleaned and then sanitized. Sanitation requires chlorine concentrations of 25 to 100 parts per million (ppm), considerably above the normal concentration used to chlorinate drinking water. These waters are discharged to sanitary sewers where available.

However, transmission lines from remote water supply sources often pass through both rural and urban-fringe areas where sanitary sewers are not available. In these areas, chlorinated water may have to be discharged to a nearby stream or storm drain, particularly since the emptying of a pipe section occurs at low points that frequently exist at stream crossings. Although prior to disposal the water is dechlorinated using sodium thiosulfate or a comparable chemical, malfunctioning of the dechlorination system can kill fish and other aquatic life. The drainage from reservoirs located in areas without sewers is conveyed to storm drains. The cleaning of sewer lines and maintenance holes generates sediments. These sediments contain both inorganic and organic materials are odorous and contaminated with microorganisms and heavy metals. Activities around sewage treatment plants can be a source of nonpoint pollution. Besides the normal runoff of stormwater from paved surfaces, grit removed from the headworks of the plant is stored temporarily in dumpsters that may be exposed to the elements. Maintenance and repair shops may produce waste paints, used oil, cleaning solvents, and soiled rags.

## ***Port Districts***

### **Description**

The port districts considered here include the following business activities: recreational boat marinas and launch ramps; airfields; container trans-shipment; bulk material import/export, including farm products, lumber, logs, alumina, and cement; and break-bulk (piece) material, such as machinery, equipment, and scrap metals. Port districts frequently have tenants whose activities are not marine-dependent.

### **Potential Pollution-Generating Sources**

Marine terminals require extensive use of mobile equipment that may drip liquids. Waste materials associated with containers/vehicle/equipment washing/steam cleaning, maintenance and repair may be generated at a marine terminal. Debris can accumulate in loading/unloading or open storage areas, providing a source of stormwater contamination. Wooden debris from the crating of piece cargo crushed by passing mobile loading equipment leaches soluble pollutants when in contact with pooled stormwater. Log-sorting yards produce large quantities of bark that can be a source of suspended solids and leached pollutants. Potential pollutants include oil and grease, total suspended solids (TSS), heavy metals, and organics.

*This page has been intentionally left blank for double-sided printing.*

# Appendix 8-B: Management of Street Waste Solids and Liquids

## 8.B.1 Introduction

This appendix addresses street waste as defined in [chapter 173-350 WAC](#), Solid waste handling standards. [WAC 173-350](#) is the governing rule for management of typical street waste solids. Ecology adopted revisions to this rule that became effective September 1, 2018, in part to provide clarity on managing soils impacted by release of contaminants, such as street waste. Ecology has solid waste guidance to help ensure handlers of street waste manage it in accordance with [WAC 173-350](#). End users and other authorities may have their own requirements for street waste reuse and handling.

- Per [WAC 173-350](#):
  - **"Street waste"** means solids or dewatered materials collected from stormwater catch basins and similar stormwater treatment and conveyance structures, and materials collected during street and parking lot sweeping.

"Street waste," as defined here, does not include solids and liquids from street washing using detergents, cleaning of electrical vaults, vehicle wash sediment traps, restaurant grease traps, industrial process waste, sanitary sewage, mixed process, or combined sewage/stormwater wastes. Wastes from oil/water separators at sites that load fuel are not included as street waste. Street waste also does not include flood debris, landslide debris, and chip seal gravel.

## 8.B.2 Regulations for Street Waste Management

Street waste is solid waste. While street waste from routine road maintenance is likely not dangerous waste, it is presumed to be solid waste under [WAC 173-350](#). This Rule classifies Street Waste as a likely "contaminated soil," which is included in the definition of "solid waste." Since stormwater conveyance structures are places where contaminants from streets can accumulate at concentrations that could be harmful for indiscriminant placement, material from such structures is presumed to be "contaminated soil."

- Per [WAC 173-350](#):
  - **"Contaminated soil"** means soil containing one or more contaminants from a release and when moved from one location to another for placement on or into the ground:
    - a. Contains contaminants at concentrations that exceed a cleanup level under [chapter 173-340 WAC](#), Model Toxics Control Act—Cleanup, that would be established for existing land use at the location where soil is placed; or
    - b. Contains contaminants that affect pH, and pH of the soil is below 4.5 or above 9.5 or is not within natural background pH limits that exist at the location where soil is placed.

Unless excluded in [WAC 173-350-020](#), contaminated soil is solid waste and must be managed at a solid waste handling facility in conformance with this

chapter or [chapter 173-351 WAC](#), Criteria for municipal solid waste landfills. Characterization of material may be required based on solid waste facility acceptance standards. Examples of potentially contaminated soil may include, but are not limited to, street waste, petroleum contaminated soil, engineered soil, and soil likely to have contaminants from a release associated with industrial or historical activities.

Based on test results, street waste could contain contaminants at concentrations that would require either disposal at a permitted solid waste disposal facility, or treatment at a permitted solid waste handling facility for use.

Owners/operators storing or treating street waste prior to disposal or use are typically subject to permitting under the section in [WAC 173-350](#) dealing with “piles used for storage and treatment,” since most storage and treatment takes place in outdoor piles. Indoor or other storage or treatment is subject to permitting under the section dealing with “transfer stations and drop boxes.” To obtain a permit, an owner/operator will need to meet design standards, operating requirements, including characterization procedures and concentration limits if propose to use materials, and record keeping and reporting.

Note: Decant facilities are not subject to solid waste permitting if they will not have intermediate storage or treatment of decanted solids between the decant part of a facility operating in conformance with water quality rules and placement into transfer vehicles going to permitted solid waste facilities.

Street waste solids may contain contaminants at levels too high to allow unrestricted use. Street waste will need to meet the definition in [WAC 173-350](#) for “clean soil” in order for its management or use outside of permitted solid waste handling facilities. “Clean soil” is tied to meeting contaminant concentrations so as not to create a cleanup site where placement of materials would occur.

- Per [WAC 173-350](#):
  - **"Clean soil"** means soil that does not contain contaminants from a release. It also includes soil that contains one or more contaminants from a release and when moved from one location to another for placement on or into the ground:
    - a. Does not contain contaminants at concentrations that exceed a cleanup level under [chapter 173-340 WAC](#), Model Toxics Control Act—Cleanup, that would be established for existing land use at the location where soil is placed; or
    - b. Contains contaminants that affect pH, but pH of the soil is between 4.5 and 9.5 or within natural background pH limits that exist at the location where soil is placed.

Examples of potentially clean soil may include, but are not limited to, soil from undeveloped lands unlikely to have impacts from release of contaminants associated with area-wide or local industrial or historical activities. This includes similar soils over which development may have occurred but land use is unlikely to have led to a release, such as use for residential housing, or over which development provided protection from impacts from a release, such as coverage by pavement. Soil with substances from natural background conditions, as natural background is defined in [WAC 173-350-100](#), is clean soil under this section.



Street waste that will go directly to a permitted landfill or transfer station is not subject to the standards of [WAC 173-350](#), though operators will need to adhere to receiving facility acceptance criteria. For street waste that will not go directly to a permitted landfill or transfer station, an operator needs to consult with their jurisdictional health department to see what solid waste regulations apply to street waste management. In Washington, [chapter 70.95 RCW](#), Solid waste management – Reduction and recycling, gives jurisdictional health departments primary authority over solid waste handling and permitting.

As stated earlier, guidance will be available soon with more specificity on how to manage “contaminated soil” under the recently revised [WAC 173-350](#).

### **8.B.3 Contaminants in Street Waste Solids**

Street waste does not typically classify as dangerous waste. The owner of the stormwater facility and/or collector of street waste is considered the waste generator and responsible for deciding whether the waste designates as dangerous waste. However, sampling has historically shown that material from routine maintenance of roads and stormwater facilities does not classify as dangerous waste.

It is possible that street waste from spill sites has high enough concentration of contaminants to classify it as dangerous waste. Street waste suspected to be dangerous waste should not be collected with other street waste to avoid creating a larger volume of dangerous waste. Street waste with obvious contamination (unusual color, staining, corrosion, unusual odors, fumes, and oily sheen) should be left in place or segregated until tested. Base testing activities on probable contaminants. If collecting potentially dangerous waste because of emergency conditions, or if the waste becomes suspect after it is collected, an owner/operator should handle and store it separately until a determination as to proper disposal is made. Dangerous waste must be handled following [chapter 173-303 WAC](#), Dangerous waste regulations.

Test results from sampling street waste show that it contains contaminants including total petroleum hydrocarbons (TPH), carcinogenic polycyclic aromatic hydrocarbons (c-PAHs), and several metals. These contaminants can be at concentrations high enough to be harmful to human health and the environment unless managed appropriately. The following tables provide a summary of some past test results.

**Table 8.2: Typical TPH Levels in Street Sweeping and Catch Basin Solids**

Reference	Street Sweeping (mg/kg)	Catch Basin Solid (mg/kg)
Snohomish County (1) (Landau, 1995)	390 - 4300	
King County (1) (Herrera, 1995)		123 - 11049 (Median 1036)
Snohomish County & Selected Cities (1) (W&H Pacific, 1994)	163 - 1500 (Median 760)	163 - 1562 (Median 760)
City of Portland (2) (Bretsch, 2000)		MDL - 1830 (Median 208)
City of Seattle - Diesel Range (2) (Seattle Public Utilities and Herrera, 2009)	330 - 520	780 - 1700
City of Seattle - Motor Oil (2) (Seattle Public Utilities and Herrera, 2009)	2000 - 2800	3500 - 7000
Oregon (1) (Collins, 1998)	1600 - 2380	
Oregon (3) (Collins, 1998)	98 - 125	
(1) Method WTPH 418.1; does not incorporate new methods to reduce background interference due to vegetative material (2) Method NWTPH-Dx (3) Method WTPH - HCID		

**Table 8.3: Typical c-PAH Values in Street Waste Solids and Related Materials**

Sample Source	City of Everett					WSDOT	
	Street Sweepings	Soil	3-Way Topsoil	Vactor Solids	Leaf & Sand	Sweepings - Fresh	Sweepings - Weathered
Benzo (a)anthracene	0.1U	0.076U	0.074U	0.21	0.45	0.56	0.40
Chrysene	0.14	0.09	0.074U	0.32	0.53	0.35	0.35
Benzo(b)fluoranthene	0.11	0.076U	0.074U	0.27	0.52	0.43	0.51
Benzo(k)fluoranthene	0.13	0.076U	0.074U	0.25	0.38	0.39	0.40
Benzo (a)pyrene	0.13	0.076U	0.074U	0.26	0.5	0.41	0.33U
Indeno(1,2,3-cd)pyrene	0.1U	0.076U	0.074U	0.19	0.39	NR	NR
Dibenzo(a,h)anthracene	0.1U	0.076U	0.074U	0.081	0.12	0.39	0.33U
Revised MTCA Benzo (a)pyrene [ND=PQL]	0.215	0.134	0.134	0.388	0.727	0.708	0.597
Benzo (a)pyrene [ND = 1/2 PQL]	0.185	0.069	0.067	0.388	0.727	0.708	0.366
Benzo (a)pyrene [See * below]	0.185	0.069	0	0.388	0.727	0.708	0.366
Benzo (a)pyrene [ND = 0]	0.155	0.001	0	0.388	0.727	0.708	0.135
* If the analyte was not detected for any PAH, then ND=0; If analyte was detected in at least 1 PAH, then ND=1/2PQL; If the average concentration (using ND=1/2 PQL) is greater than the maximum detected value, then ND=Maximum value.							

**Table 8.4: Typical Metals Concentrations in Catch Basin Sediments**

PARAMETER	Ecology 1993	Thurston 1993	King County 1995	King county 1995	City of Seattle 2003 through 2011
Metals: Total (mg/kg)	(Min - Max)	(Min - Max)	(Min - Max)	Mean	Min - Max (Mean)
As	< 3 - 24	.39 - 5.4	4 - 56	0.250	<5 - 50 (9.3)
Cd	0.5 - 2.0	< 0.22 - 4.9	0.2 - 5.0	0.5	
Cr	19 - 241	5.9 - 71	13 - 100	25.8	
Cu	18 - 560	25 - 110	12 - 730	29	9.1 - 3,280 (166)
Pb	24 - 194	42 - 640	4 - 850	80	3 - 3,690 (154)
Ni	33 - 86	23 - 51	14 - 41	23	
Zn	90 - 558	97 - 580	50 - 2000	130	44 - 4170 (479)
Hg	0.04 - 0.16	0.24 - 0.193			<0.03 - 3.8 (0.16)

**Table 8.5: Pollutants in Catch Basin Solids - Comparison to Dangerous Waste Criteria**

PARAMETER	Range of Values in Catch Basin Waste	Range of Values in Catch Basin Waste	Dangerous Waste Criteria
METALS	Total Metals (mg/kg)	TCLP Metals (mg/kg)	TCLP values (mg/l)
As	<3 - 56	< 0.02 - 0.5	5.0
Cd	< 0.22 - 5	0.0002 - 0.03	1.0
Cr	5.9 - 241	0.0025 - 0.1	5.0
Cu	12 - 730	0.002 - 0.88	none
Pb	4 - 850	0.015 - 3.8	5.0
Ni	23 - 86	< 0.01 - 0.36	none
Zn	50 - 2,000	0.04 - 6.7	none
Hg	0.02 - 0.19	0.0001 - 0.0002	0.2

*Data from (Thurston County, 1993), (Herrera, 1995) and (Serdar, 1993)*

### 8.B.4 Street Waste Liquids

#### General Procedures

Street waste collection should emphasize retention of solids in preference to liquids. Street waste solids are the principal objective in street waste collection and are substantially easier to store and treat than liquids.

**Street waste liquids require treatment before their discharge.** Street waste liquids, which include eductor and street sweeping truck decant and drainage from piles and containers, usually contain high amounts of suspended and total solids and adsorbed metals. Treatment requirements depend on the discharge location.

**The entity responsible for operation and maintenance of the system must approve discharges to sanitary sewer and storm sewer systems.** Ecology will not generally require waste discharge permits for discharge of stormwater decant to sanitary sewers or to stormwater treatment BMPs constructed and maintained in accordance with this manual.

**Listed below is the required order of preference for disposal of liquid from collection of Street Wastes.**

1. **Discharge of Street Waste liquids to a municipal sanitary sewer connected to a Public Owned Treatment Works (POTW).** Discharge to a municipal sanitary sewer requires the approval of the sewer authority. Approvals for discharge to a POTW will likely contain pretreatment, quantity, and location conditions to protect the POTW. Following the local sewer authority's conditions is a permit requirement.
2. **Discharge of Street Waste liquids may be allowed into a Basic or Enhanced Runoff Treatment BMP, if option 1 is not available.** Only discharge street waste liquid into the storm sewer system under the following conditions:
  - The preferred disposal option of discharge to sanitary sewer is not reasonably available.
  - The discharge is to a Basic or Enhanced Runoff Treatment BMP. If pretreatment does not remove visible sheen from oils, the Runoff Treatment BMP must be able to prevent the discharge of oils causing a visible sheen.
  - The discharge from the eductor truck is as near to the inlet of the Runoff Treatment BMP as practical, to minimize contamination or recontamination of the collection system.
  - The storm sewer system owner/operator has granted approval and has determined that the Runoff Treatment BMP will accommodate the increased loading. Part of the approval process may include pretreatment conditions to protect the Runoff Treatment BMP. Following local pretreatment conditions is a requirement of this permit.
  - Ecology must approve in advance flocculants for the pretreatment of street waste liquids. The liquids must be non-toxic under the circumstances of use.

The discharger shall determine if reasonable availability of sanitary sewer discharge exists, by evaluating such factors as distance, time of travel, load restrictions, and capacity of the Runoff Treatment BMP.

3. **Operators may return water removed from stormwater ponds, vaults, and oversized catch basins to the storm sewer system.** Stormwater ponds, vaults, and oversized catch basins contain substantial amounts of liquid, which hampers the collection of solids and poses problems in hauling the removed waste away from the site. Water removed from these facilities may be discharged back into the pond, vault, or catch basin provided:

- Operators may discharge clear water removed from a stormwater treatment structure directly to a down gradient cell of a treatment pond or into the storm sewer system.
- Turbid water may be discharged back into the structure it was removed from if the removed water has been stored in a clean container (eductor truck, Baker tank, or other appropriate container used specifically for handling stormwater or clean water); and there will be no discharge from the treatment structure for at least 24 hours.
- The storm sewer system owner/operator must approve the discharge.

**Table 8.6: Typical Street Waste Decant Values Compared to Surface Water Quality Criteria**

PARAMETER	State Surface Water Quality Criteria		Range of Values Reported	
	Freshwater Acute (ug/l - dissolved metals)	Freshwater Chronic (ug/l - dissolved metals)	Total Metals (ug/l)	Dissolved Metals (ug/l)
Arsenic	360	190	100 - 43,000	60 - 100
Cadmium*	2.73	0.84	64 - 2,400	2 - 5
Chromium (total)			13 - 90,000	3 - 6
Chromium (III)*	435	141		
Chromium (VI)	0.5	10		
Copper*	13.04	8.92	81 - 200,000	3 - 66
Lead*	47.3	1.85	255 - 230,000	1 - 50
Nickel*	1114	124	40 - 330	20 - 80
Zinc*	90.1	82.3	401 - 440,000	1,900 - 61,000
Mercury	2.10	0.012	0.5 - 21.9	
<i>*Hardness dependent; hardness assumed to be 75 mg/L</i>				

**Table 8.7: Typical Values for Conventional Pollutants in Street Waste Decant**

PARAMETER	Ecology 1993	(Min - Max)	King County 1995	(Min - Max)
Values as mg/l; except where stated	Mean		Mean	
pH	6.94	6.18 - 7.98	8	6.18 - 11.25
Conductivity (umhos/cm)	364	184 - 1,110	480	129 - 10,100
Hardness (mg/l CaCO <sub>3</sub> )	234	73 - 762		
Fecal Coliform (MPN/100 ml)	3,000			
BOD	151	28 - 1,250		
COD	900	120 - 26,900		
Oil & Grease	11	7.0 - 40	471	15 - 6,242
TOC	136	49 - 7,880	3,670	203 - 30,185
Total Solids	1,930	586 - 70,400		
Total Dissolved Solids	212	95 - 550		
Total Suspended Solids	2,960	265 - 111,000		
Settleable Solids (ml/l/hr)	27	2 - 234	57	1 - 740
Turbidity (ntu)	1,000	55 - 52,000	4,673	43 - 78,000

**Table 8.8: Street Waste Decant Values Following Settling**

PARAMETER; Total Metals in mg/l	Portland - Inverness Site Min - Max	King County - Renton Min - Max	METRO Pretreatment Discharge Limits
Arsenic	0.0027 - 0.015	< MDL - 0.12	4
Cadmium	0.0009 - 0.0150	< MDL - 0.11	0.6
Chromium	0.0046 - 0.0980	0.017 - 0.189	5
Copper	0.015 - 0.8600	0.0501 - 0.408	8
Lead	0.050 - 6.60	0.152 - 2.83	4
Nickel	0.0052 - 0.10	0.056 - 0.187	5
Silver	0.0003 - 0.010	< MDL	3
Zinc	0.130 - 1.90	0.152 - 3.10	10

**Table 8.8: Street Waste Decant Values Following Settling (continued)**

PARAMETER; Total Metals in mg/l	Portland - Inverness Site Min - Max	King County - Renton Min - Max	METRO Pretreatment Discharge Limits
Settleable Solids; ml/L	No Data	0.02 - 2.0	7
Nonpolar FOG	5.7 - 25	5 - 22	100
Ph (std)	6.1 - 7.2	6.74 - 8.26	5.0 - 12.0
TSS	2.8 - 1310		
Recorded Total Monthly Flow; Gallons	Data not available	31,850 - 111,050	
Recorded Max. Daily Flow; Gallons	Data not available	4,500 - 18,600	25,000 GPD
Calculated Average Daily Flow; GPD	Data not available	1,517 - 5,428	
1) Data from King County's Renton Facility (data from 1998 - 1999) and the City of Portland's Inverness Site (data from 1999 - 2001); detention times not provided			

### 8.B.5 Collection Site Assessment

**Ecology suggests a collection site assessment to identify spills or locations that potentially contain dangerous wastes.**

The collection site assessment will aid in determining if waste is a dangerous waste and in deciding what to test for if dangerous waste is suspected. The collection site assessment will also help determine if the waste meets the requirements of the receiving facility.

There are three steps to a collection site assessment:

1. A **historical review** of the site for spills, previous contamination and nearby cleanup sites or dangerous waste facilities.

The historical review will be easier if done on an area wide basis prior to scheduling any waste collection. The historical review should be more thorough for operators who have never collected waste at the site before. At a minimum, the historical review should include operator knowledge of the area's collection history or records from previous waste collections.

Private operators should ask the owner of the site for records of previous contamination and the timing of the most recent cleaning. Ecology's Hazardous Substance Information Office maintains a Toxic Release Inventory and a Facility/Site Database, tracking more than 15,000 sites.

Ecology's online Facility/Site Database is available at [www.ecy.wa.gov/fs/](http://www.ecy.wa.gov/fs/).

The database allows anyone with web-access to search for facility information by address, facility name, town, zip code, and SIC code, etc. It lists why Ecology is tracking each one (NPDES, TSCA, RCRA, Clean Air Act, etc.), as well as who to call within Ecology to find out



more about the given facility. EPA's toxic release website is [http://i-  
aspub.epa.gov/triexplorer/tri\\_release.chemical](http://i-<br/>aspub.epa.gov/triexplorer/tri_release.chemical)

2. A **visual inspection** for potential contaminant sources such as a past fire, leaking tanks and electrical transformers, and surface stains.

Take a look at the area for contaminant sources prior to collection of the waste. If the inspection finds a potential contaminant source, delay the waste collection until the potential contaminant is assessed.

A second portion of the visual inspection is a good housekeeping assessment of the area. Locations with poor housekeeping commonly cut corners in less obvious places. Inspect these sites in greater detail for illegal dumping and other contamination spreading practices.

3. **Sweeping route, catch basin, waste, and container inspection** before and during collection.

The inspection of the waste and catch basin or vault is the last and perhaps most critical step in the collection site assessment.

For example, if the stormwater facility has an unusual color in or around it, then it is possible someone dumped something near it or into it. Some colors to be particularly wary of are yellow/green from antifreeze dumping and black and rainbow sheen from oil and/or grease dumping. In addition, if the inspector observes any staining or corrosion, then a solvent may have been dumped.

Fumes are also good indicators of potential contamination. Avoid deliberate smelling of catch basins for worker safety, but suspicious odors may be encountered from catch basins thought to be safe. Some suspicious odors are rotten eggs (hydrogen sulfide is present), gasoline or diesel fumes, or solvent odors. If unusual odors are noted, contact a dangerous waste inspector before cleaning the basin.

*Finally, operator experience is the best guide to avoid collection of contaminated waste.*

*This page has been intentionally left blank for double-sided printing.*

## **Appendix 8-C: Stormwater Pollutants and Their Adverse Impacts**

The stormwater pollutants of most concern are total suspended solids (TSS), oil and grease, nutrients, pesticides, other organics, pathogens, biochemical oxygen demand (BOD), heavy metals, and salts (chlorides) ([U.S. EPA, 1995](#)), ([Field et al., 1997](#)), ([Strecker et al., 1997](#)).

### ***Total Suspended Solids***

This represents particulate solids such as eroded soil, heavy metal precipitates, and biological solids (all considered as conventional pollutants), which can cause sedimentation in streams and turbidity in receiving surface waters. These sediments can destroy the desired habitat for fish and can impact drinking water supplies. The sediment may be carried to streams, lakes, or other receiving waters where they may be toxic to aquatic life and make dredging necessary.

### ***Oil and Grease***

Oil and grease can be toxic to aquatic life. Concentrations in stormwater from commercial and industrial areas often exceed the Washington State Department of Ecology (Ecology) guidelines of 10 milligrams per liter (mg/L) maximum daily average, 15 mg/L maximum at any time, and no ongoing or frequently recurring visible sheen.

### ***Nutrients***

Phosphorus and nitrogen compounds can cause excessive growth of aquatic vegetation in lakes and marine waters.

### ***Biochemical Oxygen Demand***

BOD is a measure of the oxygen demand from organic, nitrogenous and other materials that are consumed by bacteria present in receiving waters. High levels of BOD indicate that the oxygen content is being depleted by this decomposition process, threatening organisms that are higher on the food chain such as fish.

### ***Toxic Organics***

A study found 19 of the U.S. Environmental Protection Agency's 121 priority pollutants in the runoff from Seattle streets. The most frequently detected pollutants were pesticides, phenols, phthalates, and polycyclic aromatic hydrocarbons (PAHs).

### ***Heavy Metals***

Stormwater can contain heavy metals such as lead, zinc, cadmium, and copper at concentrations that often exceed water quality criteria and that can be toxic to fish and other aquatic life. Research in Puget Sound has shown that metals and toxic organics concentrate in sediments and at the water surface (microlayer) where they interfere with the reproductive cycle of many biotic species and cause tumors and lesions in fish.

## ***pH***

A measure of the alkalinity or acidity, pH can be toxic to fish if it varies appreciably from neutral pH of 7.0.

## ***Bacteria and Viruses***

Stormwater can contain disease-causing bacteria and viruses, although not at concentrations found in sanitary sewage. Shellfish subjected to stormwater discharges near urban areas are usually unsafe for human consumption. Research has shown that the concentrations of pollutants in stormwater from residential, commercial, and industrial areas can exceed the Washington State Department of Ecology water quality standards and guidelines.

# Glossary

The definitions of terms and abbreviations in this glossary are provided for use with the *Stormwater Management Manual for Eastern Washington*. They shall be superseded by any other definitions adopted by ordinance, unless they are defined in the Washington Administrative Code (WAC) or the Revised Code of Washington (RCW).

## A

### **AASHTO classification**

The official classification of soil materials and soil aggregate mixtures for highway construction, used by the American Association of State Highway and Transportation Officials.

### **AASHTO H-20**

The load representing a truck used in design of highways and bridges. The basic design truck is a single unit weighing 40 kips. A kip (often called a kilopound) represents 1,000 pound-force. The subsequent HS-20 designation represents higher loads typical of tractor-semi-trailer combinations.

### **Absorption**

The penetration of a substance into or through another, such as the dissolving of a soluble gas in a liquid.

### **ADA**

Americans With Disabilities Act

### **Adaptive management**

The modification of management practices to address changing conditions and new knowledge. Adaptive management is an approach that incorporates monitoring and research to allow projects and activities, including projects designed to produce environmental benefits, to go forward in the face of some uncertainty regarding consequences. The key provision of adaptive management is the responsibility to change adaptively in response to new understanding or information after an action is initiated.

### **Administrator**

A local jurisdiction official authorized to make decisions regarding adjustments and exceptions/variances.

### **Adsorption**

The adhesion of a substance to the surface of a solid or liquid; often used to extract pollutants by causing them to be attached to such adsorbents as activated carbon or silica gel. Hydrophobic, or water-repulsing adsorbents, are used to extract oil from waterways when oil spills occur. Heavy metals such as zinc and lead often adsorb to sediment particles.

### **ADT**

Average daily traffic

## **Aeration**

The process of supplying or impregnating a substance with air. In waste treatment, the process used to foster biological and chemical purification. In soils, the process by which air in the soil is replenished by air from the atmosphere. In a well-aerated soil, the soil air is similar in composition to the atmosphere above the soil. Poorly aerated soils usually contain a much higher percentage of carbon dioxide and a correspondingly lower percentage of oxygen.

## **AKART**

All known, available, and reasonable methods of prevention, control, and treatment.

## **AMC**

Antecedent moisture condition

## **Animal Feeding Operation**

A lot or facility (other than an aquatic animal production facility) where the following conditions are met:

- i. Animals (other than aquatic animals) have been, are, or will be stabled or confined and fed or maintained for a total of 45 days or more in any 12-month period, and
- ii. (ii) Crops, vegetation, forage growth, or post-harvest residues are not sustained in the normal growing season over any portion of the lot or facility.

## **Annual flood**

The highest peak discharge, on average, that can be expected in any given year.

## **ANSI**

American National Standards Institute

## **Antecedent moisture condition (AMC)**

The degree of wetness of a watershed or within the soil at the beginning of a storm.

## **API**

American Petroleum Institute

## **Applicable BMPs**

As used in Chapters 2 and 8, applicable BMPs are those source control BMPs that are expected to be required by local jurisdictions at new development and redevelopment sites. Applicable BMPs will also be required if they are incorporated into Municipal Stormwater Permits, or if they are included by local jurisdictions in a stormwater program for existing facilities.

## **Aquifer**

A geologic stratum containing ground water that can be withdrawn and used for human purposes.

## **Arid**

Excessively dry; having insufficient rainfall to support agriculture without irrigation.

## **Arterial**

A road or street primarily for through traffic. A major arterial connects an interstate highway to cities and counties. A minor arterial connects major arterials to collectors. A collector connects an arterial to a neighborhood. A collector is not an arterial. A local access road connects individual homes to a collector.

## **ATB**

Asphalt-treated base

## **Average daily traffic (ADT)**

The expected number of vehicles using a roadway is represented by the projected ADT volume considered in designing the roadway. ADT counts must be estimated using the *Trip Generation Manual* published by the Institute of Transportation Engineers or a traffic study prepared by a licensed engineer in the state of Washington or a transportation specialist with expertise in traffic volume estimation. ADT counts shall be made for the design life of the project. For project sites with seasonal or varied use, the highest period of expected traffic impacts should be evaluated.

## **AWWA**

American Water Works Association

## **B**

### **Baffle**

A device for checking, deflecting, or regulating flow.

### **Bankfull discharge**

A flow condition where streamflow completely fills the stream channel up to the top of the bank. In undisturbed watersheds, the discharge conditions occur on average every 1.5 to 2 years and control the shape and form of natural channels.

### **Base flood**

A flood having a 1 percent chance of being equaled or exceeded in any given year. Also referred to as the 100-year flood.

### **Basic treatment**

Treatment of stormwater with the goal of removing at least 80% of the solids in the runoff using one of the runoff treatment BMPs or methods identified in [Chapter 5 - Runoff Treatment BMP Design](#). Basic treatment is required for all discharges that meet the thresholds in [2.7.6 Core Element #5: Runoff Treatment](#). Additional treatment to remove metals, oil, or phosphorus may be required at some sites or for some receiving water bodies.

### **Bedload**

Sediment particles that are transported as a result of shear stress created by flowing water, that move along, and that are in frequent contact with the streambed.

### **Bedrock**

The more or less solid rock in place, either on or beneath the surface of the earth. It may be soft,

medium, or hard, and have a smooth or irregular surface.

### **Beneficial uses**

Those water uses identified in state water quality standards that must be achieved and maintained as required under the federal Clean Water Act. “Beneficial use” and “designated use” are often used interchangeably.

### **Berm**

A constructed barrier of compacted earth, rock, or gravel. In a stormwater BMP, a berm may serve as a vertical divider typically built up from the bottom.

### **Best available science**

The technical provisions in the *Stormwater Management Manual for Eastern Washington* represent common provisions for the protection of waters of the state from adverse impacts of urban stormwater. Implementation of these provisions is necessary to minimize project-specific and cumulative impacts on waters of the state. This manual reflects the best available science and practices related to protection of water quality. The manual will incorporate new information as it becomes available and allow alternative practices that provide equal or greater protection for waters of the state.

### **Best Management Practices (BMPs)**

The schedules of activities, prohibitions of practices, maintenance procedures, and structural and/or managerial practices approved by Ecology that, when used singly or in combination, prevent or reduce the release of pollutants and other adverse impacts on waters of Washington State.

### **BFM**

Bonded fiber matrix

### **Binding Site Plan**

A drawing to a scale specified by local ordinance which (a) identifies and shows the areas and locations of all streets, roads, improvements, utilities, open spaces, and any other matters specified by local regulations; (b) contains inscriptions or attachments setting forth such appropriate limitations and conditions for the use of the land as are established by the local jurisdiction having authority to approve the site plan; and (c) contains provisions making any development be in conformity with the site plan ([RCW 58.17.020](#)).

### **Biochemical oxygen demand (BOD)**

An indirect measure of the concentration of biologically degradable materials present in organic wastes. The amount of free oxygen used by aerobic organisms when allowed to attack the organic material in an aerobically maintained environment at a specified temperature (20°C) for a specific time period (5 days), and thus stated as BOD5. It is expressed in milligrams of oxygen used per liter of liquid waste volume (mg/L) or in milligrams of oxygen per kilogram of waste solution (mg/kg = ppm = parts per million). Also called biological oxygen demand.

### **Biofiltration**

The process of reducing pollutant concentrations in water by filtering the polluted water through biological materials. Pollutant removal mechanisms include sedimentation, filtration, soil



sorption and/or biological uptake. This type of BMP can provide runoff treatment and conveyance, but not flow control.

### **Bioinfiltration**

The process of using a combination of vegetation and soils to remove stormwater pollutants by infiltration into the ground. Pollutant removal mechanisms include filtration, soil sorption, and biological uptake. This type of BMP can provide runoff treatment but not flow control.

### **Biological control**

A method of controlling pest organisms by means of introduced or naturally occurring predatory organisms, sterilization, the use of inhibiting hormones, or other means, rather than by mechanical or chemical means.

### **Bioretention**

Shallow landscaped depressions with a designed soil mix and a variety of plant material, including trees, shrubs, grasses, and/or other herbaceous plants adapted to the local climate and soil moisture conditions that receive stormwater runoff from a small contributing area. This type of BMP can provide runoff treatment, flow control, and conveyance.

### **Biosolids**

Municipal sewage sludge that is a primarily organic, semisolid product resulting from the wastewater treatment process, can be beneficially recycled, and meets all applicable requirements under [Chapter 173-308 WAC](#). Biosolids include a material derived from biosolids and septic tank sludge, also known as septage, that can be beneficially recycled and meets all applicable requirements under [Chapter 173-308 WAC](#). For the purposes of [Chapter 173-308 WAC](#), semisolid products include biosolids or products derived from biosolids ranging in character from mostly liquid to fully dried solids.

### **Biotic integrity**

The condition where the biologic or living community of an aquatic or terrestrial system is unimpaired and the complement of species diversity and richness expected for that system is present.

### **BMP**

Best Management Practice

### **BOD**

Biochemical oxygen demand

### **Bole**

The trunk of a tree.

### **BSM**

Bioretention soil media

### **BST**

Bituminous surface treatment

## **Buffer zone**

The area adjacent to a critical or sensitive area for which location and limits are described by federal, state, or local jurisdictions and intent is ensuring protection of the critical area by separating incompatible use from the critical or sensitive area.

## **C**

### **California bearing ratio**

A test using a plunger of a specific area to penetrate a soil sample to determine the load-bearing strength of a road subgrade.

### **Catch basin**

A chamber or well, usually built at the curb line of a street, for the admission of surface water to a sewer or subdrain, having at its base a sediment sump designed to retain grit and detritus below the point of overflow.

### **Catchment**

Surface drainage area

### **Cation exchange capacity (CEC)**

The amount of exchangeable cations that a soil can adsorb. Units are milliequivalents per 100 grams of soil, typically abbreviated as meq. Soil found to have a CEC of 5 meq at pH 7.0 will have a CEC < 5 meq when pH < 7.0.

### **CAVFS**

Compost-amended vegetated filter strip

### **CEC**

Cation exchange capacity

### **Certified Erosion and Sediment Control Lead (CESCL)**

An individual who is knowledgeable in the principles and practices of erosion and sediment control. The CESCL shall have the skills to assess the site conditions and construction activities that could impact the quality of stormwater and the effectiveness of erosion and sediment control measures used to control the quality of stormwater discharges. The CESCL shall have current certification from an approved erosion and sediment control training program that meets the minimum training standards established by Ecology (see [BMP C160E: Certified Erosion and Sediment Control Lead](#)).

### **CESCL**

Certified Erosion and Sediment Control Lead

### **Channel, constructed**

A reconstructed natural channel or other channel or ditch constructed to convey surface water.

### **Channel, natural**

A stream, creek, or swale that conveys surface water and ground water and has existed long enough to establish a stable route and/or biological community.

**Channel stabilization**

Erosion prevention and stabilization of velocity distribution in a channel using vegetation, jetties, drops, revetments, and/or other measures.

**Channel storage**

Water temporarily stored in channels while enroute to an outlet.

**Channelization**

Alteration of a stream channel by widening, deepening, straightening, cleaning, or paving certain areas to change flow characteristics.

**Check dam**

Small dam constructed in a gully or other small watercourse to decrease the streamflow velocity, minimize channel scour, and promote deposition of sediment.

**Chemical oxygen demand (COD)**

A measure of the amount of oxygen required to oxidize organic and oxidizable inorganic compounds in water. The COD test, like the BOD test, is used to determine the degree of pollution in water.

**CN**

Curve number

**COD**

Chemical oxygen demand

**Coliform bacteria**

Microorganisms common in the intestinal tracts of man and other warm-blooded animals; all the aerobic and facultative anaerobic, gram-negative, non-spore-forming, rod-shaped bacteria that ferment lactose with gas formation within 48 hours at 35°C. Used as an indicator of bacterial pollution.

**Commercial agriculture**

Activities conducted on lands defined in [RCW 84.34.020](#)(2) and activities involved in the production of crops or livestock for wholesale trade. An activity ceases to be considered commercial agriculture when the area on which it is conducted is proposed for conversion to a nonagricultural use or has lain idle for more than 5 years, unless the idle land is registered in a federal or state soils conservation program or unless the activity is maintenance of irrigation ditches, laterals, canals, or drainage ditches related to an existing and ongoing agricultural activity.

**Common plan of development or sale**

A site where multiple separate and distinct construction activities may be taking place at different times on different schedules and/or by different contractors but still under a single plan. Examples include (1) phased projects and projects with multiple filings or lots, even if the separate phases or filings/lots will be constructed under separate contract or by separate owners (e.g., a development where lots are sold to separate builders); (2) a development plan that may be phased over multiple years but is still under a consistent plan for long-term

development; and (3) projects in a contiguous area that may be unrelated but still under the same contract, such as construction of a building extension and a new parking lot at the same facility. If the project is part of a common plan of development or sale, the disturbed area of the entire plan shall be used in determining permit requirements.

### **Compaction**

The densification, settlement, or packing of soil in such a way that permeability of the soil is reduced. Compaction effectively shifts the performance of a hydrologic soil group to a lower permeability hydrologic soil group. For example, a group B hydrologic soil can be compacted and effectively converted to a group C hydrologic soil in the way it performs in terms of runoff. Compaction may also refer to the densification of a fill by mechanical means.

### **Complete Streets Policies**

Complete streets are designed and operated to allow safe access for multimodal users, including pedestrians, bicyclists, motorists, and transit riders of all ages and abilities.

### **Concurrency**

The timely provision of public facilities and services at the time when development occurs or within a specified period. The Growth Management Act requires that public facilities be provided concurrently with new development.

### **Conservation district**

A public organization created under state enabling law as a special-purpose district to develop and carry out a program of soil, water, and related resource conservation, use, and development within its boundaries, usually a subdivision of state government with a local governing body and always with limited authority. Often called a soil conservation district or a soil and water conservation district.

### **Constructed wetland**

Wetlands intentionally created on sites that are not wetlands for the primary purpose of wastewater or stormwater treatment and managed as such. Constructed wetlands are normally considered part of the stormwater collection and treatment system.

### **Construction Stormwater Pollution Prevention Plan (SWPPP)**

A document that describes the potential for pollution problems on a construction project and explains and illustrates the measures to be taken on the construction site to control those problems.

### **Conveyance**

A mechanism for transporting water from one point to another, including pipes, ditches, and channels.

### **Conveyance system**

Drainage facilities, both natural and constructed that collect, contain, and provide for the flow of surface and stormwater from the highest points on the land down to a receiving water. The natural elements of the conveyance system include swales and small drainage courses, streams, rivers, lakes, and wetlands. Constructed elements of the conveyance system include gutters, ditches, pipes, channels, and most retention/detention facilities.

**CP**

Coalescing plate

**CPESC**

Certified Professional in Erosion and Sediment Control

**Critical area**

At a minimum, areas that include wetlands, areas with a critical recharging effect on aquifers used for potable water, fish and wildlife habitat conservation areas, frequently flooded areas, geologically hazardous areas (including unstable slopes), and associated areas and ecosystems.

**Crown projection**

The perimeter of a tree's crown (outermost extent of the branches and foliage) projected vertically to the ground.

**CSBC**

Crushed surfacing base course

**CSO**

Combined sewer overflow

**CSWGP**

Construction Stormwater General Permit

**CTAPE**

Chemical Technology Assessment Protocol–Ecology

**CTRC**

Chemical Technical Review Committee

**CULD**

Conditional Use Level Designation

**Culvert**

Pipe or concrete box structure that drains open channels, swales or ditches under a roadway or embankment, typically, with no catch basins or maintenance holes along its length.

**Cut-and-fill**

Process of earth moving by excavating part of an area and using the excavated material for adjacent embankments or fill areas.

**Custom design storm**

A synthetic rainfall event used to design runoff treatment BMPs in a particular jurisdiction. The design storm must be based on a statistical analysis of local historical precipitation data and reviewed and approved by the local jurisdiction.

## **D**

### **Dangerous waste**

According to [RCW 70.105.010](#), any discarded, useless, unwanted, or abandoned substances, including, but not limited to, certain pesticides, or any residues or containers of such substances that are disposed of in such quantity or concentration as to pose a substantial, present, or potential hazard to human health, wildlife, or the environment. These wastes may have short-lived, toxic properties that may cause death, injury, or illness or have mutagenic, teratogenic, or carcinogenic properties; or be corrosive, explosive, flammable; or may generate pressure through decomposition or other means. See also [Hazardous waste](#).

### **Dead storage**

The volume available in a depression in the ground below any conveyance system, or surface drainage pathway, or outlet invert elevation that could allow the discharge of surface and stormwater runoff.

### **Denitrification**

The reduction of nitrate (commonly by bacteria) to dinitrogen gas.

### **Design deviation**

Project-specific modification of one or more design criteria based on site-specific conditions approved by the local jurisdiction.

### **Design storm**

A prescribed hyetograph or precipitation distribution and the total precipitation amount (for a specific duration recurrence frequency) used to estimate runoff for a hypothetical storm of interest or concern for the purposes of analyzing existing drainage, designing new drainage facilities, or assessing other impacts of a proposed project on the flow of surface water.

Examples include the SCS Type IA and Type II storms, modified Type IA storms, regional storms, long-duration storms, short-duration storms, and custom design storms.

### **Design storm frequency**

The anticipated period in years that will elapse, based on the average probability of storms in the design region, before a storm of a given intensity and/or total volume will recur. Thus a 10-year storm can be expected to occur on the average once every 10 years; the same storm has a 10% chance of occurring each year. Facilities designed to handle flows that occur under such storm conditions would be expected to be surcharged by any storms of greater amount or intensity.

### **Detention**

The release of stormwater runoff from the site at a slower rate than it is collected by the stormwater BMP, the difference being held in temporary storage.

### **Detention BMP**

An aboveground or belowground BMP, such as a pond or tank, that temporarily stores stormwater runoff and subsequently releases it at a slower rate than it is collected by the drainage system. There is little or no infiltration of stored stormwater.

## **Detention time**

The theoretical time required to displace the contents of a runoff treatment BMP at a given rate of discharge (volume divided by rate of discharge).

## **Development**

[New development](#), [Redevelopment](#), or both. See definitions for each.

## **Discharge**

Runoff leaving a new development or redevelopment by overland flow, built conveyance systems, or infiltration facilities. A hydraulic rate of flow, specifically fluid flow; a volume of fluid passing a point per unit of time, commonly expressed as cubic feet per second, cubic meters per second, gallons per minute, gallons per day, or million gallons per day.

## **Dispersion**

Release of surface and stormwater runoff from a drainage system such that the flow spreads over a wide area and is located so as not to allow flow to concentrate anywhere upstream of a drainage channel with erodible underlying granular soils.

## **Ditch**

A long, narrow excavation dug in the earth for drainage with its top width < 10 feet at design flow.

## **DOH**

Washington State Department of Health

## **DNR**

Washington State Department of Natural Resources

## **Drain**

A buried pipe or other conduit (closed drain). A ditch (open drain) for carrying off surplus surface water or ground water.

## **Drainage system**

The system of gutters, pipes, streams, or ditches used to carry surface water and stormwater from surrounding lands to streams or lakes. Includes constructed and natural features that function together as a system to collect, convey, channel, hold, inhibit, retain, detain, infiltrate, divert, treat, or filter stormwater.

## **Drawdown**

Lowering of the water surface (in open-channel flow), water table, or piezometric surface (in ground water flow) resulting from a withdrawal of water.

## **Drywell**

A well completed above the water table so that its bottom and sides are typically dry except when receiving fluids. Drywells are designed to disperse water below the land surface and are commonly used for stormwater management in eastern Washington. See also [UIC](#).

## **E**

### **Easement**

The legal right to use a parcel of land for a particular purpose. It does not include fee ownership but may restrict the owner's use of the land.

### **Ecology**

Washington State Department of Ecology

### **Effective impervious surface**

Impervious surfaces that are connected by means of sheet flow or discrete conveyance to a drainage system or receiving body of water. Most impervious areas are effective. The Washington State Department of Ecology considers impervious areas in residential development to be ineffective if the runoff is dispersed through at least 100 feet of native vegetation using approved dispersion techniques.

### **EIA**

Effective impervious area

### **EMC**

Event mean concentration

### **Embankment**

A structure of earth, gravel, or similar material raised to form a pond bank or foundation for a road.

### **Emergency spillway**

A vegetated earth channel used to safely convey flood discharges in excess of the capacity of the principal spillway.

### **Emerging technology**

Treatment technologies that have not been evaluated with approved protocols but for which preliminary data indicate that they may provide a necessary function(s) in a stormwater treatment system. Emerging technologies need additional evaluation to define design criteria to achieve, or to contribute to achieving, state performance goals and to define the limits of their use.

### **Energy dissipator**

Any means by which the total energy of flowing water is reduced. In stormwater design, they are usually mechanisms that reduce velocity prior to, or at, the point of discharge from an outfall in order to prevent erosion. They include rock splash pads, drop maintenance holes, concrete stilling basins or baffles, and check dams.

### **Erodible or leachable materials**

Substances which, when exposed to rainfall, measurably alter the physical or chemical characteristics of the rainfall runoff. Examples include erodible soils that are stockpiled, uncovered process wastes, manure, fertilizers, oily substances, ashes, kiln dust, and garbage dumpster



leakage.

## **Erosion**

The wearing away of the land surface by running water, wind, ice, or other geological agents, including such processes as gravitational creep. Also, detachment and movement of soil or rock fragments by water, wind, ice, or gravity.

## **Erosion and sediment control (ESC)**

Any temporary or permanent measures taken to reduce erosion, control siltation and sedimentation, and ensure that sediment-laden water does not leave the site.

## **Erosion and sediment control BMP**

A construction BMP designed to hold water for a period to allow sediment contained in the surface and stormwater runoff directed to the BMP to settle out to improve the quality of the runoff.

## **ESA**

Endangered Species Act (federal)

## **ESAL**

Equivalent single-axle load

## **ESC**

Erosion and sediment control

## **Eutrophication**

The process where nutrient over-enrichment of water leads to excessive growth of aquatic plants, especially algae.

## **Evapotranspiration**

The collective term for the processes of water returning to the atmosphere by interception and evaporation from plant surfaces and transpiration through plant leaves.

## **Excavation**

The mechanical removal of earth material.

## **Exception**

Exemption from the application of a Core Element to a project.

## **Exfiltration**

The downward movement of runoff through the bottom of an infiltration BMP into the soil layer or the downward movement of water through soil.

## **Existing condition**

The impervious surfaces, drainage systems, land cover, native vegetation, and soils that exist at a site prior to any changes associated with achieving the proposed development conditions. Approved permits and engineering plans may be required. If sites have impervious areas and drainage systems that were built without approved permits, the existing condition is defined as

those that existed prior to the issue date of the Municipal Stormwater Permit. Existing conditions may be verified using aerial photography or other records.

## **F**

### **FCWA**

Federal Clean Water Act

### **FEMA**

Federal Emergency Management Agency

### **FHWA**

Federal Highway Administration

### **FIFRA**

Federal Insecticide, Fungicide, and Rodenticide Act

### **Filter strip**

A grassy area with gentle slopes that treats stormwater runoff from adjacent paved areas before it concentrates into a discrete channel.

### **First order stream**

An unbranched tributary, which is a continuous perennial stream reach, meaning that the water table is always above the bottom of the stream channel during a year of normal precipitation and the perennial reach continues downstream to a confluence with another perennial stream.

### **Fish-bearing stream**

Determined by the local jurisdiction based on readily available data. According to [WAC 222-16-030](#): Type S, F, and Np waters are fish habitat streams. Until these fish habitat water type maps are available, an interim water typing system applies (see [WAC 222-16-031](#)): Type 1, 2, 3, and 4 waters are fish habitat streams.

### **Flocculation**

The process by which suspended colloidal or very fine particles are assembled into larger masses or floccules that eventually settle out of suspension. This process occurs naturally but can also result from the use of chemicals such as alum.

### **Flood**

An overflow or inundation that comes from a river or any other source, including (but not limited to) streams, tides, wave action, storm drains, or excess rainfall. Any relatively high streamflow overtopping the natural or artificial banks in any reach of a stream.

### **Flood frequency**

The frequency with which the flood of interest may be expected to occur at a site in any average interval of years. Frequency analysis defines the *x*-year flood as being the flood that will, over a long period of time, be equaled or exceeded on the average once every *x* years.

### **Flood routing**

An analytical technique used to compute the effects of system storage dynamics on the shape

and movement of flow represented by a hydrograph.

### **Flow control BMP**

A stormwater BMP designed to mitigate the impacts of increased surface and stormwater runoff flow rates generated by development. Flow control BMPs are designed either to hold water for a considerable length of time and then release it by evaporation, plant transpiration, and/or infiltration into the ground, or to hold runoff for a short period of time, releasing it to the drainage system at a controlled rate.

### **Flow duration**

The aggregate time peak flows are at or above a particular flow rate of interest. For example, the amount of time peak flow is at or above the 2-year peak flow rate for a period of record.

### **Flow frequency**

The inverse of the probability that the flow will be equaled or exceeded in any given year (the exceedance probability). For example, if the exceedance probability is 0.01 or 1 in 100, that flow is referred to as the 100-year flow.

### **Flow path**

The route that stormwater runoff follows between two points of interest.

### **Forebay**

An easily maintained, extra storage area provided near an inlet of a BMP to trap incoming sediments before they accumulate in a pond or wetland BMP.

### **Forest practice**

Any activity conducted on or directly pertaining to forest land and relating to growing, harvesting, or processing timber.

### **Freeboard**

The vertical distance between the highest designed water surface elevation and the elevation of the crest of the BMP. For example, in pond design, freeboard is the vertical distance between the emergency overflow water surface and the top of the pond embankment.

### **Freeway**

A multilane, arterial highway with full access control.

### **Frost-heave**

The upward movement of soil surface due to the expansion of water stored between particles in the first few feet of the soil profile as it freezes. May cause surface fracturing of asphalt or concrete.

### **Fully controlled limited access highway**

A highway where the right of owners or occupants of abutting land or other persons to access, light, air, or view in connection with the highway is controlled to give preference to through traffic by providing access connections with selected public roads only, and by prohibiting crossings or direct private driveway connections at grade ([WAC 468-58-010](#)).

## **Functions**

The ecological (physical, chemical, and biological) processes or attributes of a water body without regard for their importance to society. Functions include food chain support, provision of ecosystem diversity and fish and wildlife habitat, floodflow alteration, ground water recharge and discharge, water quality improvement, and soil stabilization.

## **G**

### **Gabion**

A rectangular or cylindrical wire mesh cage (a chicken wire basket) filled with rock and used as a protecting agent, revetment, etc., against erosion. Soft gabions, often used in streambank stabilization, are made of geotextiles filled with soil, in between which cuttings are placed.

### **Gauge**

A device for registering precipitation, water level, discharge, velocity, pressure, temperature, etc. Also, a measure of the thickness of metal; e.g., diameter of wire or wall thickness of steel pipe.

### **Ground water**

Water in a saturated zone or stratum beneath the land surface or beneath a surface water body ([WAC 173-200-020](#)).

### **Ground water protection area**

A geographic area that is by or close by a surrounding community and nontransient noncommunity water system, that uses ground water as a source of drinking water (40 C.F.R. 144.87) and other sensitive ground water areas critical to protecting underground sources of drinking water from contamination; such as sole source aquifers, highly productive aquifers supplying private wells, critical aquifer recharge areas and/or other state and local areas determined by state and local governments.

### **Ground water recharge**

Inflow to a ground water reservoir or aquifer.

### **Ground water table**

The free surface of the ground water, that surface subject to atmospheric pressure under the ground, generally rising and falling with the season, the rate of withdrawal, the rate of restoration, and other conditions. It is seldom static.

## **GULD**

General Use Level Designation

## **Gully**

A channel caused by the concentrated flow of surface and stormwater runoff over unprotected erodible land.

## **H**

### **Habitat**

The specific area or environment in which a particular type of plant or animal lives. An

organism's habitat must provide all of the basic requirements for life and should be protected from harmful biological, chemical, and physical alterations.

### **Hardpan**

A cemented or compacted and often clay-like layer of soil that is impenetrable by roots. Also known as glacial till.

### **Hazardous waste**

According to [RCW 70.105.010](#), all dangerous and extremely hazardous waste, including substances composed of both radioactive and hazardous components. See also [Dangerous waste](#).

### **Hazardous substance**

Any liquid, solid, gas, or sludge, including any material, substance, product, commodity, or waste, regardless of quantity, that exhibits any of the physical, chemical, or biological properties described in [WAC 173-303-090](#) or [WAC 173-303-100](#). See also [Dangerous waste](#).

### **Head (hydraulics)**

The height of water above any plane of reference. The energy, either kinetic or potential, possessed by each unit weight of a liquid, expressed as the vertical height through which a unit weight would have to fall to release the average energy possessed. Used in various compound terms such as pressure head, velocity head, and head loss.

### **Head loss**

Energy loss due to friction, eddies, changes in velocity, or changes in direction of flow.

### **Heavy metals**

Metals of high specific gravity that are present in municipal and industrial wastes and pose long-term environmental hazards. Heavy metals include cadmium, chromium, cobalt, copper, lead, mercury, nickel, and zinc.

### **High-ADT roadways and parking areas**

Any road with average daily traffic (ADT) > 30,000 vehicles; and parking areas with either more than 100 trip ends per 1,000 square feet of gross building area or > 300 total trip ends are high-use traffic areas. Examples include commercial buildings with a frequent turnover of customers and other visitors.

### **High-use sites**

Sites that generate high concentrations of oil due to high traffic turnover or the frequent transfer of oil and/or other petroleum products (see [Chapter 2 - Core Elements for New Development and Redevelopment](#)).

### **Highway**

A main public road connecting towns and cities.

### **Hog fuel**

Wood-based mulch

**HPA**

Hydraulic Project Approval

**HRM**

Highway Runoff Manual

**HSPF**

Hydrological Simulation Program-Fortran. A continuous simulation hydrologic model that transforms an uninterrupted rainfall record into a concurrent series of runoff or flow data by means of a set of mathematical algorithms that represent the rainfall-runoff process at some conceptual level.

**Hydraulic conductivity**

The quality of saturated soil that enables water or air to move through it. Also known as permeability coefficient.

**Hydraulic gradient**

Slope of the potential head relative to a fixed datum.

**Hydrograph**

A graph of runoff rate, inflow rate, discharge rate, or another characteristic of a body of water during a specific period.

**Hydrologic cycle**

The circuit of water movement from the atmosphere to the earth and return to the atmosphere through various stages or processes as precipitation, interception, runoff, infiltration, percolation, storage, evaporation, and transpiration.

**Hydrologic soil groups**

A soil characteristic classification system defined by the U.S. Soil Conservation Service in which a soil may be categorized into one of four soil groups (A, B, C, or D) based on infiltration rate and other properties.

**Hydrology**

The science of the behavior of water in the atmosphere, on the surface of the earth, and underground.

**Hydroperiod**

A seasonal occurrence of flooding and/or soil saturation; it encompasses depth, frequency, duration, and seasonal pattern of inundation.

**Hyetograph**

A graph or table of percentages of total precipitation for a series of time steps representing the total time in which precipitation occurs.

/

**ICPI**

Interlocking Concrete Pavement Institute

## **IFC**

International Fire Code

## **Illicit discharge**

All nonstormwater discharges to drainage systems that cause or contribute to a violation of state water quality, sediment quality, or ground water quality standards, including, but not limited to, sanitary sewer connections, industrial process water, interior floor drains, car washing, and greywater systems.

## **Impaired waters**

Water bodies that do not fully support their beneficial uses.

## **Impervious surface**

A hard surface area that either prevents or retards the entry of water into the soil mantle as under natural conditions prior to development. A hard surface area that causes water to run off the surface in greater quantities or at an increased rate of flow from the flow present under natural conditions prior to development. Common impervious surfaces include, but are not limited to, rooftops, walkways, patios, driveways, parking lots or storage areas, concrete or asphalt pavement, gravel roads, packed earthen materials, and oiled macadam or other surfaces that similarly impede the natural infiltration of stormwater. For purposes of determining whether the thresholds for application of core elements are exceeded, open, uncovered retention or detention facilities shall not be considered as impervious surfaces. Open, uncovered retention or detention BMP shall be considered impervious surfaces for the purposes of runoff modeling.

## **Impoundment**

A natural or constructed containment for surface water.

## **Improvements**

Improvement projects replace paved or other impervious areas with a better surface, and/or in a way that enhances the traffic-carrying capacity of a road or parking area and/or improves safety.

## **Industrial activities**

Material handling, transportation, or storage; manufacturing; maintenance; treatment; or disposal. Areas with industrial activities include plant yards, access roads and rail lines used by carriers of raw materials, manufactured products, waste material, or by-products; material handling sites; refuse sites; sites used for the application or disposal of process waste waters; sites used for the storage and maintenance of material handling equipment; sites used for residual treatment, storage, or disposal; shipping and receiving areas; manufacturing buildings; storage areas for raw materials and intermediate and finished products; and areas where industrial activity has taken place in the past and significant materials remain and are exposed to stormwater.

## **Ineffective impervious surface**

Impervious surfaces on residential development sites where the runoff is not concentrated and is dispersed by means of sheet flow off the pavement, and then through at least 100 feet of

native vegetation before flowing into a drainage system. An example is a tennis court in the middle of a park.

### **Infiltration**

The downward movement of water from the land surface to the subsoil.

### **Infiltration BMP**

A drainage BMP designed to use the hydrologic process of surface and stormwater runoff soaking into the ground, commonly referred to as a percolation, to dispose of surface and stormwater runoff.

### **Infiltration rate**

The rate, usually expressed in inches per hour, at which water percolates, or moves downward through the soil profile. Short-term infiltration rates may be inferred from soil analysis or texture or derived from field measurements. Long-term infiltration rates are affected by variability in soils and subsurface conditions at the site, the effectiveness of pretreatment or influent control, and the degree of long-term maintenance of the infiltration BMP.

### **Ingress/egress**

The points of access to and from a property.

### **Inlet**

A form of connection between surface of the ground and a stormwater conveyance system for the admission of surface and stormwater runoff.

### **Insecticide**

A substance, usually chemical, that is used to kill insects.

### **Interflow**

The portion of rainfall that infiltrates the soil and moves laterally through the upper soil horizons until intercepted by a stream channel or until it returns to the surface, for example, in a roadside ditch, wetland, spring, or seep. Interflow is a function of the soil system depth, permeability, and water-holding capacity.

### **Intermittent stream or intermittent channel**

A stream or portion of a stream that flows only in direct response to precipitation. Intermittent streams receive little or no water from springs and no long-continued supply from melting snow or other sources and are dry for a large part of the year.

### **Invert**

The lowest point on the inside of a sewer, drainage pipe, or other conduit.

### **IPM**

Integrated pest management

### **Irrigation ditch**

The portion of a designed and constructed conveyance system that serves the purpose of transporting irrigation water from its supply source to its place of use. This may include natural



watercourses or channels incorporated in the system design but does not include the area adjacent to the watercourse or channel.

## **ISA**

International Society of Arboriculture

## **Isopluvial map**

A map with lines representing the constant depth of total precipitation for a given return frequency.

## **ISGP**

Industrial Stormwater General Permit

## **L**

### **Lag time**

The interval between the center of mass of the storm precipitation and the peak flow of the resultant runoff.

### **Land-disturbing activity**

Any activity that results in movement of earth or a change in the existing soil cover (both vegetative and nonvegetative) and/or the existing soil topography. Land-disturbing activities include, but are not limited to, clearing, grading, filling, and excavation. Compaction associated with stabilization of structures and road construction shall also be considered a land-disturbing activity. Vegetation maintenance practices are not considered land-disturbing activity.

### **Leachable materials**

Substances that, when exposed to rainfall, measurably alter the physical or chemical characteristics of the rainfall runoff. Examples include erodible soils, uncovered process wastes, manure, fertilizers, oil substances, ashes, kiln dust, and garbage dumpster leakage.

### **Leachate**

Liquid that has percolated through soil and contains substances in solution or suspension.

### **Level-pool routing**

The basic technique of storage routing used for sizing and analyzing detention storage and determining water levels for ponding water bodies. The level-pool routing technique is based on the continuity equation: inflow minus outflow equals change in storage.

## **LID**

Low impact development

### **Liquefaction**

The temporary transformation of a soil mass of soil or sediment into a fluid mass. Liquefaction occurs when the cohesion of particles in the soil or sediment is lost.

### **Local jurisdiction**

Any county, city, town, or special-purpose district having its own incorporated government for local affairs.

### **Long-duration design storm**

One of the four design storms consisting of two rainfall events separated by a dry period that were developed for climate regions identified in eastern Washington. The storms were based on a statistical analysis of historical precipitation in eastern Washington and have been adapted for use in this manual as single-hump design storms consisting of only one continuous rainfall event. See [Modified SCS Type IA design storm](#) and [Regional design storm](#). Also see further discussion in [Appendix 4-A: Background Information on Design Storms and Selected Modeling Methods](#)

### **Los Angeles (L.A.) abrasion**

The standard L.A. abrasion test subjects a coarse aggregate sample (retained on the No. 12 or 1.70-millimeter [mm] sieve) to abrasion, impact, and grinding in a rotating steel drum containing a specified number of steel spheres. After being subjected to the rotating drum, the weight of aggregate that is retained on a No. 12 (1.70 mm) sieve is subtracted from the original weight to obtain a percentage of the total aggregate weight that has broken down and passed through the No. 12 (1.70 mm) sieve. Therefore, an L.A. abrasion loss value of 40 indicates that 40% of the original sample passed through the No. 12 (1.70 mm) sieve. The standard Los Angeles abrasion test is AASHTO T 96 or ASTM C 131, Resistance to Degradation of Small-Size Coarse Aggregate by Abrasion and Impact in the Los Angeles Machine.

### **Low-ADT roadways and parking areas**

Urban roads with average daily traffic (ADT) fewer than 7,500 vehicles, rural roads and freeways with ADT < 15,000 vehicles, and parking areas with both < 40 trip ends per 1,000 square feet of gross building area and < 100 total trip ends per day are considered low-use traffic areas. Examples include most residential parking and employee-only parking areas for small office parks or other commercial buildings. Urban roads are located within designated Urban Growth Management Areas; rural roads are located outside designated Urban Growth Management Areas. Freeways may be located either inside or outside Urban Growth Management Areas.

### **Low-flow channel**

An incised or paved channel from inlet to outlet in a dry basin that is designed to carry low runoff flows and/or baseflow, directly to the outlet without detention.

### **Low impact development (LID)**

A stormwater and land use management strategy that strives to mimic predisturbance hydrologic processes of infiltration, filtration, storage, evaporation, and transpiration by emphasizing conservation, use of on-site natural features, site planning, and distributed stormwater management practices that are integrated into a project design.

### **Low-permeability liner**

A layer of compacted till or clay or a geomembrane.

## **M**

### **Maintenance**

Repair and maintenance refers to activities conducted on currently serviceable structures, BMPs, and equipment that involve no expansion or use beyond previously existing use and

result in no significant adverse hydrologic impact. It includes the usual activities performed to prevent a decline, lapse, or cessation in the use of structures and systems. It includes replacement of dysfunctional BMPs, including cases where environmental permits require replacing an existing structure with a different type of structure, if the functioning characteristics of the original structure are not changed. For example, replacing a collapsed fish-blocking round culvert with a new box culvert under the same span, or width, of roadway. For further details on the application of this manual to various road management functions, see [2.2 Exemptions](#), [2.3 Partial Exemptions](#), and [2.6 Redevelopment](#).

### **Manning's equation**

An equation used to predict the velocity of water flow in an open channel or pipeline.

### **MAP**

Mean annual precipitation

### **Maximum extent practicable**

Refers to paragraph 402(p)(3)(B)(iii) of the federal Clean Water Act, which reads as follows: "Permits for discharges from municipal storm sewers shall require controls to reduce the discharge of pollutants to the maximum extent practicable, including management practices, control techniques, and system, design, and engineering methods, and other such provisions as the Administrator or the State determines appropriate for the control of such pollutants."

### **MBFM**

Mechanically bonded fiber matrix

### **Metals**

Elements such as lead, mercury, copper, cadmium, and zinc that are of environmental concern because they can be toxic to aquatic life and do not degrade over time.

### **MFD**

Media filter drain

### **Mitigation**

In the following order of preference, mitigation is defined as:

1. Avoiding the impact altogether by not taking a certain action or part of an action
2. Minimizing impacts by limiting the degree or magnitude of the action and its implementation by using appropriate technology or by taking affirmative steps to avoid or reduce impacts
3. Rectifying the impact by repairing, rehabilitating, or restoring the affected environment
4. Reducing or eliminating the impact over time by preservation and maintenance operations during the life of the action
5. Compensating for the impact by replacing, enhancing, or providing substitute resources or environments

### **Moderate-ADT roadways and parking areas**

Urban roads with average daily traffic (ADT) between 7,500 and 30,000 vehicles; rural roads and freeways with ADT between 15,000 and 30,000 vehicles; and parking areas with either between 40 and 100 trip ends per 1,000 square feet of gross building area or between 100 and 300 total trip ends per day are considered moderate-use traffic areas. Examples include visitor parking for small to medium commercial buildings with a limited number of daily customers. Urban roads are located within designated Urban Growth Management Areas; rural roads are located outside designated Urban Growth Management Areas. Freeways may be located either inside or outside Urban Growth Management Areas.

### **Moderate-use sites**

Moderate-use sites include moderate-ADT roadways and parking areas, primary access points for high-density residential apartments, most intersections controlled by traffic signals, and transit center bus stops. These sites are expected to generate sufficient concentrations of metals that additional runoff treatment is needed to protect water quality in nonexempt surface waters.

### **Modified SCS Type IA design storm**

An adapted application of the synthetic SCS Type IA design storm to more closely reflect historical precipitation patterns in eastern Washington. Antecedent moisture conditions and precipitation depths are modified to reflect more typical conditions. See [4.3.5 Modified SCS Type IA and Regional Design Storms](#) for a complete description.

### **Modified wetland**

A wetland where the physical, hydrological, or water quality characteristics have been purposefully altered for a management purpose, such as, by dredging, filling, forebay construction, and inlet or outlet control.

### **Monitoring**

The systematic collection of data by various methods for the purposes of understanding natural systems and features, evaluating the impacts of development proposals on such systems, and assessing the performance of mitigation measures imposed as conditions of development.

### **MS4**

Municipal separate storm sewer system

### **MTCA**

Model Toxics Control Act

### **Municipality**

Every city, county, town, district, or other public agency thereof that is authorized by law to require the execution of public work, except drainage districts, diking districts, diking and drainage improvement districts, drainage improvement districts, diking improvement districts, consolidated diking and drainage improvement districts, consolidated drainage improvement districts, consolidated diking improvement districts, irrigation districts, or any such other districts as shall from time to time be authorized by law for the reclamation or development of waste or undeveloped lands.

## **Municipal Stormwater Permit**

Phase II Municipal Stormwater National Pollutant Discharge Elimination System (NPDES) Permit for eastern Washington

## **Mycorrhizal**

Relating to the symbiotic association of the mycelium of a fungus with the roots of a seed plant.

## **N**

## **National Pollutant Discharge Elimination System (NPDES)**

A provision of the Clean Water Act that prohibits point-source discharges of pollutants into waters of the United States unless a special permit is issued and administered by the U.S. EPA or by Ecology, as the delegated authority in Washington State. Municipal separate storm sewer systems (MS4s) are classified as point-source discharges.

## **Native growth protection easement (NGPE)**

An easement granted for the protection of native vegetation within a sensitive area or its associated buffer. The NPGE shall be recorded on the appropriate documents of title and filed with the county records division.

## **Native vegetation**

Vegetation comprising plant species that are indigenous to eastern Washington and that reasonably could be expected to naturally occur on the site. Plant species classified as noxious weeds are excluded from this definition.

## **Natural conditions**

Surface water quality present before any human-caused pollution. When estimating natural conditions in the headwaters of a disturbed watershed, it may be necessary to use the less disturbed conditions of a neighboring or similar watershed as a reference condition.

## **Natural location**

The location of those channels, swales, and other nonconstructed conveyance systems, as defined by the first documented topographic contours for the subject property, either from maps or photographs, or such other means as appropriate. In the case of outwash soils with relatively flat terrain, no natural location of surface discharge may exist.

## **New development**

Land-disturbing activities, including Class IV general forest practices that are conversions from timber land to other uses; structural development, including construction or installation of a building or other structure; creation of impervious surfaces; and subdivision, short subdivision and binding site plans. Projects meeting the definition of redevelopment shall not be considered new development.

## **NGPE**

Native growth protection easement

## **Nitrate (NO<sub>3</sub>)**

A form of nitrogen that is an essential nutrient for plants. It can cause algal blooms in water if all

other nutrients are present in sufficient quantities. It is a product of bacterial oxidation of other forms of nitrogen; it also comes from the atmosphere during electrical storms and from fertilizer manufacturing.

### **Nitrification**

The process in which ammonium is converted to nitrite and then nitrate by specialized bacteria.

### **Nonendangerment Standard**

Activities that prevent the movement of fluid containing any contaminant into the ground water if the contaminant may cause a violation of the Water Quality Standards for ground waters of the state of Washington, [Chapter 173-200 WAC](#), or may cause health concerns.

### **Non-fish-bearing stream**

According to [WAC 222-16-030](#): Type Ns waters are non-fish-habitat streams. Until fish habitat water type maps are available, an interim water typing system applies (see [WAC 222-16-031](#)): Type 5 waters are non-fish-habitat streams.

### **Non-pollution-generating impervious surface (NPGIS)**

NPGIS are considered insignificant sources of pollutants in stormwater runoff. Roofs that are subjected only to atmospheric deposition or normal heating, ventilation, and air conditioning vents are considered NPGIS, unless the roofing material is uncoated metal. The following may also be considered NPGIS: paved bicycle pathways and pedestrian sidewalks that are separated from and not subjected to drainage from roads for motor vehicles, fenced fire lanes, infrequently used maintenance access roads, and “in-slope” areas of roads. Sidewalks that are regularly treated with sand, salt, or other deicing and anti-icing chemicals are *not* considered NPGIS.

### **Nonpoint-source pollution**

Pollution that enters any waters of the state from any dispersed land-based or water-based activities and does not result from discernible, confined, or discrete conveyances.

### **NPDES**

National Pollutant Discharge Elimination System

### **NPGIS**

Non-pollution-generating impervious surface

### **NRCS Method (formerly the SCS Method)**

A single-event hydrologic analysis technique for estimating runoff based on the Curve Number method. The curve numbers are published by the NRCS in Technical Release No. 55, *Urban Hydrology for Small Watersheds*, 1986. With the change in name from the Soil Conservation Service to the Natural Resources Conservation Service, the method may be referred to as the NRCS Method.

### **NRCS**

Natural Resources Conservation Service (formerly the Soil Conservation Service)

### **Nutrients**

Essential chemicals needed by plants and animals for growth. Excessive amounts of nutrients

can lead to degradation of water quality and algal blooms. Some nutrients can be toxic at high concentrations.

## **O**

### **Off-line facilities**

Water quality treatment facilities to which stormwater runoff is restricted to some maximum flow rate or volume by a flow splitter.

### **Off-system storage**

Facilities for holding or retaining excess flows over and above the carrying capacity of the stormwater conveyance system, in chambers, tanks, lagoons, ponds, or other basins that are not a part of the subsurface sewer system.

### **OHWM**

Ordinary high water mark

### **Oil**

Oil of any kind or any form, including, but not limited to, petroleum, fuel oil, sludge, oil refuse, and oil mixed with wastes other than dredged spoil.

### **Oil and water separator**

A vault, usually underground, designed to provide a quiescent environment to separate oil from water.

### **O&M**

Operation and maintenance

### **Online facilities**

Runoff treatment BMPs that receive all of the stormwater runoff from a drainage area. Flows greater than the water quality design flow rate or volume are passed through at a lower percentage of removal efficiency.

### **On-site stormwater management BMPs**

Development and mitigation techniques that serve to infiltrate, disperse, and retain stormwater runoff on a project site.

### **Operational BMPs**

A type of source control BMP, operational BMPs are schedules of activities, prohibition of practices, and other managerial practices to prevent or reduce pollutants from entering stormwater. They include formation of a pollution prevention team, good housekeeping, preventive maintenance procedures, spill prevention and cleanup, employee training, inspections of pollutant sources and BMPs, and record keeping. They can also include process changes, raw material/product changes, and recycling wastes.

### **Ordinary high water mark (OHWM)**

The line on the shore established by the fluctuations of water and indicated by physical characteristics such as a clear, natural line impressed on the bank; shelving; changes in the character

of soil destruction on terrestrial vegetation or the presence of litter and debris; or other appropriate means that consider the characteristics of the surrounding area. The OHWM is found by examining the bed and banks of a stream and ascertaining where the presence and action of waters are so common and usual, and so long-maintained in all ordinary years, as to mark upon the soil a character distinct from that of the abutting upland, in terms of vegetation. In any area where the OHWM cannot be found, the line of mean high water shall be substituted. In any area where neither can be found, the channel bank shall be substituted. In braided channels and alluvial fans, the OHWM or its substitute shall be measured to include the entire stream feature.

### **Organic matter**

Decomposed animal or vegetable matter measured by ASTM D2974. Organic matter is an important reservoir of carbon and a dynamic component of soil and the carbon cycle. It improves soil and plant efficiency by improving soil physical properties including drainage, aeration, and other structural characteristics. It contains substances necessary for plant growth: nutrients, microbes, and organisms. The maturity of organic matter is a measure of its beneficial properties. Raw organic matter can release water-soluble nutrients (similar to chemical fertilizer). Beneficial organic matter has undergone a humification process, either naturally in the environment or through a composting process.

### **Orifice**

An opening with closed perimeter, usually sharp-edged, and of regular form in a plate, wall, or partition through which water may flow, generally used for the purpose of measurement or control of water.

### **OSHA**

Occupational Safety and Health Administration

### **Outfall**

An opening with closed perimeter, usually sharp-edged, and of regular form in a plate, wall, or partition through which water may flow; generally used for the purpose of measurement or control of water.

### **Outlet**

Point of water disposal from a stream, river, lake, tidewater, or artificial drain.

### **Outlet channel**

A waterway constructed or altered primarily to carry water from structures, such as terraces, tile lines, and diversions.

### **Outwash soils**

Soils formed from highly permeable sands and gravels.

### **Overflow**

A pipeline or conduit device, together with an outlet pipe, that provides for the discharge of portions of combined sewer flows into receiving waters or other points of disposal, after a regular device has allowed the portion of the flow that can be handled by interceptor sewer lines and pumping and treatment facilities to be carried by and to such water pollution control



structures.

### **Overflow rate**

Detention basin release rate divided by the surface area of the basin. It can be thought of as an average flow rate through the basin.

### **Overtopping**

Flow over the limits of a containment or conveyance element.

## **P**

### **PAH**

Polycyclic aromatic hydrocarbon

### **PAM**

Polyacrylamide

### **Partially controlled limited access highway**

A highway where the right of owner or occupants of abutting land or other persons to access, light, air, or view in connection with the highway is controlled to give preference to through traffic to a degree that, in addition to access connections with selected public roads, there may be some crossings and some private driveway connections at grade ([WAC 468-58-010](#)).

### **Particle size**

The effective diameter of a particle as measured by sedimentation, sieving, or micrometric methods.

### **PCB**

Polychlorinated biphenyl

### **Peak discharge**

The maximum instantaneous rate of flow during a storm, usually in reference to a specific design storm event.

### **Peak-shaving**

Controlling postdevelopment peak discharge rates to predevelopment levels by providing temporary detention in a BMP.

### **Percolation**

The movement of water through soil.

### **Percolation rate**

The rate, often expressed in minutes per inch, at which clear water, maintained at a relatively constant depth, will seep out of a standardized test hole that has been previously saturated. The term percolation rate is often used synonymously with infiltration rate or short-term infiltration rate.

### **Perennial stream**

A stream reach that does not go dry during a year of normal precipitation: the elevation of the

water table is always above the bottom of the stream channel during a year of normal precipitation.

### **Permanent Stormwater Control Plan**

A plan that includes permanent BMPs for preventing and controlling pollution of stormwater runoff. These BMPs will remain in place after construction and/or land-disturbing activity has been completed.

### **Permeable pavement**

Pervious concrete, porous asphalt, permeable pavers, or other forms of pervious or porous paving material intended to allow passage of water through the pavement section. It often includes an aggregate base that provides structural support and acts as a stormwater reservoir.

### **Permeable soils**

Soil materials with a sufficiently rapid infiltration rate to greatly reduce or eliminate surface and stormwater runoff. These soils are generally classified as SCS hydrologic soil groups A and B.

### **Pesticide**

A general term used to describe any substance—usually chemical—used to destroy or control organisms, including herbicides, insecticides, algicides, fungicides, and others. Many of these substances are manufactured and are not found in the natural environment. Others, such as pyrethrum, are natural toxins that are extracted from plants and animals.

### **PGIS**

Pollution-generating impervious surfaces

### **PGPS**

Pollution-generating pervious surfaces

### **pH**

A measure of the alkalinity or acidity of a substance represented by the concentration of hydrogen ions in the substance. Water has a neutral pH of 7.0. A pH of 6.5 is slightly acid.

### **Physiography**

Characteristics of the natural physical environment (including hills).

### **PICP**

Permeable interlocking concrete pavement

### **PIF**

Peak intensity factor

### **PIT**

Pilot infiltration test

### **Plan approval authority**

The department within a local jurisdiction that has been delegated authority to approve Stormwater Site Plans.

**Plat**

A map or representation of a subdivision showing the division of a tract or parcel of land into lots, blocks, streets, or other divisions and dedications.

**Point discharge**

The release of collected and/or concentrated surface and stormwater runoff from a pipe, culvert, or channel.

**Point of compliance**

The location at which compliance with a discharge performance standard or a receiving water quality standard is measured.

**Pollution**

Contamination or other alteration of the physical, chemical, or biological properties of waters of the state, including a change in temperature, taste, color, turbidity, or odor; or such discharge of any liquid, gaseous, solid, radioactive, or other substance into any waters of the state as will, or is likely to, create a nuisance or render such waters harmful, detrimental, or injurious to the public health, safety, or welfare, or to domestic, commercial, industrial, agricultural, recreational, or other legitimate beneficial uses, or to livestock, wild animals, birds, fish, or other aquatic life.

**Pollution-generating impervious surface (PGIS)**

Pollution-generating impervious surfaces are considered significant sources of pollutants in stormwater runoff. Such surfaces include those that are subjected to use by vehicles, industrial activities, or storage of erodible or leachable materials that receive direct rainfall or run-on or blow-in of rainfall. Metal roofs are considered to be PGIS, unless coated with an inert, nonleachable material. Roofs that are subject to venting of manufacturing, commercial (such as restaurants or processing facilities where oils and other solid particles are expected to be expelled), or other indoor pollutants are also considered PGIS. A surface, whether paved or not, shall be considered PGIS if it is regularly used by motor vehicles. The following are considered regularly used surfaces: roads, unvegetated road shoulders, bike lanes within the traveled lane of a roadway, driveways, parking lots, unfenced fire lanes, vehicular equipment storage yards, and airport runways.

**Pollution-generating pervious surface (PGPS)**

Any pervious surface subjected to the use of pesticides and fertilizers or a loss of soil. Typical PGPSs include lawns, landscaped areas, golf courses, parks, cemeteries, and sports fields.

**Potholing**

Excavating a hole in the ground to observe buried utilities or facilities. Potholes are typically excavated with the use of a backhoe or by hand, depending on the environment.

**POTW**

Publicly owned treatment works

**Predeveloped condition**

The native vegetation and soils that existed at a site prior to the influence of Euro-American settlement. Jurisdictions may choose to require that either the predeveloped condition or the

“existing condition” be used to calculate runoff volumes to be compared to the runoff generated under the “proposed development condition.” Because there is limited information available to identify and confirm actual predeveloped conditions for many areas of eastern Washington, jurisdictions may choose to apply a reasonably determined set of conservative curve numbers for use in determining the runoff volume compared to that under the proposed development condition.

### **Prediction**

For the purposes of this manual an expected outcome based on the results of hydrologic modeling and/or the judgment of a licensed engineer in the state of Washington or a registered geologist in the state of Washington with hydrogeology specialty.

### **Preservation/maintenance**

A preservation or maintenance project is defined as preserving/protecting infrastructure by rehabilitating or replacing existing structures to maintain operational and structural integrity, and for the safe and efficient operation of the BMP. Traffic area maintenance projects do not increase the traffic-carrying capacity of a roadway or parking area.

### **Pretreatment**

A BMP that removes  $\geq 50\%$  solids. Typically installed upstream of a UIC well or runoff treatment BMP.

### **Process wastewater**

The used water and solids from an industrial source. This water should be directed to a treatment facility and kept separate from the stormwater generated from the site.

### **Project**

Any proposed action to alter or develop a site; or the proposed action of a permit application or an approval that requires drainage review.

### **Project site**

That portion of a property, properties, or right-of-way subjected to land-disturbing activities and new or replaced impervious surfaces.

### **Proposed development condition**

The impervious surfaces, drainage systems, land cover, native vegetation, and soils that are proposed to exist at the site at the completion of the project (complete build-out).

### **Properly functioning soil system**

A natural system that has not been disturbed or modified or an engineered soil/landscape system designed to meet certain criteria.

### **PULD**

Pilot Use Level Designation

### **Q**

### **Qualified personnel**

Someone who has had professional training in the aspects of stormwater management for

which they are responsible and are under the functional control of the Permittee. Qualified personnel may be staff members, contractors, and/or volunteers.

## **R**

### **Rare, threatened, or endangered species**

Native plant or animal species listed in rule by the Washington State Department of Fish and Wildlife pursuant to [RCW 77.12.020](#) as threatened ([WAC 232-12-011](#)) or endangered ([WAC 232-12-014](#)), or that are listed as threatened or endangered species under the federal Endangered Species Act, 16 U.S.C. 1533. Rare plant or animal species are regionally relatively uncommon, are nearing endangered status, or their existence is in immediate jeopardy and is usually restricted to highly specific habitats. Rare species are unofficial species of concern.

### **Rational Method**

A method of computing storm drainage flow rates (Q) using the formula  $Q = CIA$ , where C is a coefficient describing the physical drainage area, I is the rainfall intensity, and A is the area. In this manual, use of the Rational Method is limited to sizing only certain types of runoff treatment BMPs, drywells, and conveyance; see [Chapter 4 - Hydrologic Analysis and Design](#).

### **RCW**

Revised Code of Washington

### **Reach**

A length of a water body with uniform characteristics.

### **Receiving waters**

Bodies of water or surface water systems to which surface runoff is discharged via a point source of stormwater or via sheet flow.

### **Recommended BMPs**

As used in Chapters 2 and 8, recommended BMPs are those that are not expected to be mandatory by local jurisdictions at new development and redevelopment sites. However, they may improve pollutant control efficiency and may provide a more comprehensive and environmentally effective stormwater management program.

### **Redevelopment**

On a site that is already substantially developed, the replacement or improvement of impervious surfaces, including buildings and other structures, and replacement or improvement of impervious parking and road surfaces, that is not part of a routine maintenance activity. Any new impervious surfaces created by a redevelopment project are subject to the requirements for new development.

### **Regional design storm**

A custom synthetic design storm taken from the long-duration design storm that was based on a statistical analysis of historical precipitation data from gauging stations in eastern Washington. The four regional storms consist of the second, or larger precipitation event, of the two contained in each of the four long-duration storms identified for the four climate regions of eastern Washington.

## **Regional detention BMP**

A flow control BMP designed to correct existing stormwater runoff problems of a basin or subbasin. The area downstream has been previously identified as having existing or predicted significant and regional flooding and/or erosion problems. This term is also used when a detention BMP is sited to detain stormwater runoff from multiple new developments or areas within a catchment.

## **Release rate**

The computed peak rate of surface and stormwater runoff from a site.

## **Replaced impervious surface**

For structures, the removal and replacement of any exterior impervious surfaces or foundation. For other impervious surfaces, the removal down to bare soil or base course and replacement.

## **Replaced pollution-generating impervious surface**

A replaced impervious surface that is a pollution-generating impervious surface.

## **Residential density**

The number of dwelling units per unit of surface area. Net density includes only occupied land. Gross density includes unoccupied portions of residential areas, such as roads and open space.

## **Retention**

The process of collecting and holding surface and stormwater runoff with no surface outflow.

## **Retention/detention BMP**

A type of drainage BMP designed either to hold water for a considerable length of time and then release it by evaporation, plant transpiration, and/or infiltration into the ground or to hold surface and stormwater runoff for a short period of time and then release it to the surface and stormwater management system.

## **Retrofit of a UIC Well**

Application of source control activities and/or structural controls such as a treatment BMP or creation of separation between the base of the well and the top of the groundwater table, to reduce the pollutant load to a UIC well so as to meet the nonendangerment standard.

## **Retrofitting**

The renovation of an existing structure or BMP to meet changed conditions or to improve performance.

## **Return frequency or recurrence interval**

A statistical term for the average expected time interval between events (e.g., flows, floods, droughts, or rainfall) that equal or exceed given conditions.

## **Rhizome**

A modified plant stem that grows horizontally underground.

## **Riffles**

Fast sections of a stream where shallow water races over stones and gravel. Riffles usually

support a wider variety of bottom organisms than other stream sections.

### **Rill**

A small intermittent watercourse with steep sides, usually only a few inches deep. Often rills are caused by an increase in surface water flow after the soil has been cleared of vegetation.

### **Riparian**

Pertaining to the banks of streams, wetlands, lakes, or tidewater.

### **Riprap**

A facing layer or protective mound of rocks placed to prevent erosion or sloughing of a structure or embankment due to flow of surface and stormwater runoff.

### **Riser**

A vertical pipe extending from the bottom of a pond BMP that is used to control the discharge rate from a BMP for a specified design storm.

### **Runoff**

Water that travels across the land surface, or laterally through the ground near the land surface, and discharges to water bodies either directly or through a collection and conveyance system. See also [Stormwater](#).

### **Runoff treatment BMP**

A BMP that is intended to remove pollutants from stormwater. Examples include detention ponds, oil and water separators, biofiltration swales, and constructed wetlands.

### **Rural road**

A roadway located outside the boundary of an Urban Growth Area.

### **RUSLE**

Revised Universal Soil Loss Equation.

## **S**

### **Sanitary control area**

The inner circle of a wellhead protection area maintained around a drinking water source to minimize direct contamination at the wellhead and reduce the possibility of surface flows reaching the wellhead and traveling down the casing ([WAC 246-290-135](#)).

### **Saturated hydraulic conductivity**

The ability of a fluid to flow through a porous medium under saturated conditions, which is determined by the size and shape of the pore spaces in the medium and their degree of interconnection and by the viscosity of the fluid. Hydraulic conductivity can be expressed as the volume of fluid that will move during unit of time under a unit hydraulic gradient through a unit area measured at right angles to the direction of flow.

### **Saturation point**

In soils, the point at which a soil or an aquifer will no longer absorb any amount of water without losing an equal amount.

**SBUH**

Santa Barbara Urban Hydrograph

**SC**

Spill control

**Scour**

Erosion of channel banks due to excessive velocity of the flow of surface and stormwater runoff.

**SCS**

Soil Conservation Service (former name of the Natural Resources Conservation Service),  
U.S. Department of Agriculture

**SCS Method**

See [NRCS Method \(formerly the SCS Method\)](#).

**SDS**

Safety Data Sheet

**Seasonal stream**

A stream or segment of a stream that normally dries up during a year of normal rainfall. Seasonal streams often receive water from springs and/or long-continued water supply from melting snow or other sources.

**Sediment**

Fragmented material that originates from weathering and erosion of rocks or unconsolidated deposits and is transported by, suspended in, or deposited by water.

**Semiarid**

A condition characterized by light rainfall; having approximately 10 to 20 inches of annual precipitation.

**Sensitive area**

Any area designated by a federal, state, or local jurisdictions to have unique or important environmental characteristics that may require special additional protective measures. These areas include, but are not limited to, wetlands and their buffer zones, stream riparian areas, wellhead protection areas, and geologic hazard areas. See also [Critical area](#).

**Settleable solids**

Suspended solids in stormwater that separate by settling when the stormwater is held in a quiescent condition for a specified time.

**Sheet flow**

Runoff that flows over the ground surface as a thin, even layer, not concentrated in a channel.

**Short-duration design storm**

A synthetic 3-hour custom design storm that represents rainfall during a typical summer thunderstorm in eastern Washington. The storm is based on a statistical analysis of historical



precipitation data from gauging stations in eastern Washington.

### **Short subdivision**

Division or redivision of land into four or fewer lots, tracts, parcels, sites, or divisions for the purpose of sale, lease, or transfer of ownership ([RCW 58.17.020](#)).

### **Siltation**

The process by which a river, lake, or other water body becomes clogged with sediment. Silt can clog gravel beds and prevent successful salmon spawning.

### **Site**

The area defined by legal boundaries of a parcel or parcels of land that is (are) subjected to new development or redevelopment. For road projects, the length of the project site and the right-of-way boundaries define the site.

### **Site Suitability Criteria**

Eight criteria that must be considered for siting infiltration BMPs for flow control and nine criteria that must be considered for siting infiltration BMPs for runoff treatment.

### **Soil stabilization**

The use of measures, such as rock lining, vegetation, or other engineering structures, to prevent the movement of soil when loads are applied to the soil.

### **Soil stratigraphy**

The sequence, spacing, composition, and spatial distribution of sedimentary deposits and soil strata (layers).

### **Soil bulk density**

The ratio of the mass of a given soil sample to the bulk volume of the sample.

### **Sorption**

The physical or chemical binding of pollutants to sediment or organic particles.

### **Source control BMP**

A structure or operation intended to prevent pollutants from encountering stormwater through physical separation of areas or careful management of activities that are sources of pollutants. This manual separates source control BMPs into two types: structural and operational. Structural source control BMPs are physical, structural, or mechanical devices or facilities that are intended to prevent pollutants from entering stormwater. Operational source control BMPs are nonstructural practices that prevent or reduce pollutants from entering stormwater. See [Chapter 8 - Source Control](#) for details.

### **SPCC**

Spill prevention control and countermeasures

### **Spill control device**

A tee section or turn-down elbow designed to retain a limited volume of pollutant that floats on water, such as oil or antifreeze. Spill control devices are passive and must be cleaned out for

the spilled pollutant to be removed.

### **Spillway**

A passage such as a paved apron or channel for surplus water over or around a dam or similar obstruction. An open or closed channel, or both, used to convey excess water from a reservoir. It may contain gates, either manually or automatically controlled, to regulate the discharge of excess water.

### **SSC**

Site Suitability Criteria (or Criterion)

### **SSP**

Stormwater Site Plan

### **Stage-storage-discharge table**

Relationship between the stage, or water surface elevation inside a stormwater BMP, and the available storage volume and discharge rates from the BMP. Available storage may include subsurface storage (e.g., storage within the voids of bioretention soil mix or aggregate reservoir layers), as well as surface ponding storage (e.g., surface ponding in a bioretention swale). Discharge may include infiltration to native soils, flow through underdrains, and/or flow-through overflow control structures, based on designs. The stage-storage-discharge table is developed by the designer for use in level-pool routing modeling to size LID BMPs.

### **State Environmental Policy Act (SEPA)**

The Washington State law intended to minimize environmental damage. SEPA requires that state agencies and local governments consider environmental factors when making decisions on activities, such as development proposals over a certain size and comprehensive plans. As part of this process, environmental documents are prepared and opportunities for public comment are provided. See [RCW 43.21c](#).

### **Storage routing**

A method to account for the attenuation of peak flows passing through a detention BMP or other storage feature.

### **Storm drain**

A drain that carries stormwater and surface water, street wash, and other wash waters or drainage but excludes sewage and industrial wastes.

### **Stormwater**

Runoff during and following precipitation and snowmelt events, including surface runoff, drainage or interflow.

### **Stormwater BMP**

A constructed component of a drainage system designed or constructed to perform a particular function or multiple functions. Stormwater BMPs include, but are not limited to, pipes, swales, ditches, culverts, street gutters, detention ponds, retention ponds, constructed wetlands, infiltration devices, catch basins, oil and water separators, and biofiltration swales.

## **Stormwater Management Manual for Eastern Washington (referred to herein as the manual)**

Contains BMPs to prevent, control, or treat pollution in stormwater and to reduce other stormwater-related impacts on waters of the state. The manual is intended to provide guidance on measures necessary in eastern Washington to control the quantity and quality of stormwater runoff from new development and redevelopment.

## **Stormwater Management Manual for Western Washington (SWMMWW)**

Contains BMPs to prevent, control or treat pollution in stormwater and to reduce other stormwater-related impacts on waters of the state. The SWMMWW is intended to provide guidance on measures necessary in western Washington to control the quantity and quality of stormwater runoff from new development and redevelopment.

## **Stormwater Site Plan (SSP)**

The comprehensive report containing all of the technical information and analysis necessary for regulatory agencies to evaluate a proposed new development or redevelopment project for compliance with stormwater requirements. Contents of the SSP will vary with the type and size of the project and individual site characteristics. The SSP includes a Construction Stormwater Pollution Prevention Plan (Construction SWPPP) and a Permanent Stormwater Control Plan (PSC Plan). Guidance for preparing an SSP is provided in [Chapter 3 - Preparation of Stormwater Site Plans](#).

## **Stream**

An area where there is sufficient surface water flow to produce a defined channel or bed. A defined channel or bed is an area that demonstrates clear evidence of the passage of water including, but not limited to, hydraulically sorted sediments or the removal of vegetative litter or loosely rooted vegetation by the action of moving water. The channel or bed need not contain water year-round. This definition is not meant to include irrigation ditches, canals, stormwater runoff devices, or other entirely artificial receiving waters, unless they are used to convey streams naturally occurring prior to construction. Topographic features that resemble streams but have no defined channels (i.e., swales) shall be considered streams when hydrologic and hydraulic analyses performed pursuant to a development proposal predict the formation of a defined channel after development.

## **Stream order**

A dimensionless basin characteristic indicating the degree of stream channel branching, used in geomorphology and runoff studies. An  $n$ th order stream is formed by two or more streams of  $(n-1)$  order: a second order stream exists below the confluence of two first order streams, a third order stream exists below the confluence of two second order streams, and so on.

## **Subbasin**

A drainage area that drains to a receiving water that is named and noted on common maps and contained within a basin.

## **Subdivision**

The division or redivision of land into five or more lots, tracts, parcels, sites, or divisions for the purpose of sale, lease, or transfer of ownership ([RCW 58.17.020](#)).

**Subdrain**

A pervious backfilled trench containing aggregate or a pipe for intercepting ground water or seepage.

**Substrate**

The natural soil base underlying a BMP.

**Surface waters of the state**

All waters defined as “waters of the United States” in [40 CFR 122.2](#) that are within the boundaries of the state of Washington. This includes lakes, rivers, ponds, streams, inland waters, wetlands, ocean, bays, estuaries, sounds, and inlets.

**Susceptibility**

The ease with which contaminants can move from the land surface to the aquifer, based solely on the types of surface and subsurface materials in the area. Susceptibility usually defines the rate at which a contaminant will reach an aquifer unimpeded by chemical interactions with the vadose zone media.

**Susceptible drinking water source**

Sources rated highly susceptible by DOH and any drinking water source where a deep injection well will be placed within a ground water protection area.

**Suspended solids**

Organic or inorganic particles suspended in and carried by the water. The term includes sand, mud, and clay particles (and associated pollutants), as well as solids in stormwater.

**Swale**

A shallow drainage conveyance with relatively gentle side slopes, generally with flow depths < 1 foot.

**SWPPP**

Stormwater Pollution Prevention Plan

**T****TAPE**

Technology Assessment Protocol–Ecology

**Terrace**

An embankment or combination of an embankment and channel across a slope to control erosion by diverting or storing surface runoff instead of permitting it to flow uninterrupted down the slope.

**TIA**

Total impervious area.

**Tightline**

A continuous length of pipe that conveys water from one point to another (typically down a

steep slope) with no inlets or collection points in between.

### **Time of concentration**

The time period necessary for surface runoff to reach the outlet of a subbasin from the hydraulically most remote point in the tributary drainage area.

### **Total Maximum Daily Load (TMDL)**

A calculation of the maximum amount of a pollutant that a water body can receive and still meet the water quality standards and an allocation of that amount to the sources of the pollutant. A TMDL (also known as a Water Cleanup Plan) is the sum of the allowable loads of a single pollutant from all contributing point and nonpoint sources. The calculation must include a margin of safety to ensure that the water body can be used for the purposes the state has designated. The calculation must also account for seasonable variation in water quality. Water quality standards are set by states, territories, and tribes. They identify the uses for each water body, for example, drinking water supply, contact recreation (swimming), and aquatic-like support (fishing), and the scientific criteria to support those uses. The Clean Water Act, Section 303, establishes the water quality standards and TMDL programs.

### **TMDL**

Total Maximum Daily Load

### **Topography**

General term to include characteristics of the ground surface, such as plains, hills, mountains, degree of relief, steepness of slopes, and other physiographic features.

### **Total impervious area (TIA)**

The total area of surfaces on a developed site that inhibit infiltration of stormwater. The surfaces include, but are not limited to, conventional asphalt or concrete roads, driveways, parking lots, sidewalks or alleys, and rooftops.

### **TPH**

Total petroleum hydrocarbons

### **Transportation safety improvement projects**

Projects that improve motorized and/or nonmotorized user safety that do not enhance the traffic capacity of a roadway.

### **Travel time**

The estimated time for surface water to flow between two points of interest.

### **TRC**

Technical Review Committee

### **Treatment liner**

A layer of soil that is designed to slow the rate of infiltration and provide sufficient pollutant removal to protect ground water quality.

### **Treatment soil**

Existing or manufactured combination of sands or organics that meet Site Suitability Criteria

(SSC) 6: Soil Physical and Chemical Suitability for Treatment.

### **Treatment train**

A combination of two or more treatment BMPs connected in series.

### **Trip ends**

The expected number of vehicles using a parking area. Projected trip end counts for the parking area are associated with the proposed land use. Trip end counts shall be estimated using the *Trip Generation Manual* published by the Institute of Transportation Engineers or a traffic study prepared by a licensed engineer in the state of Washington or a transportation specialist with expertise in traffic volume estimation. Trip end counts shall be made for the design year or expected life of the project (the intent is for treatment facilities to be added in the earliest period of disruptive construction). For project sites with seasonal or varied use, evaluate the highest period of expected traffic impacts.

### **TSD**

Triangular silt dike

### **TSS**

Total suspended solids

### **Turbidity**

Dispersion or scattering of light in a liquid, caused by suspended solids and other factors; commonly used as a measure of suspended solids in a liquid.

### **U**

### **UFC**

Uniform Fire Code

### **UGA**

Urban Growth Area

### **UIC**

Underground injection control

### **Underdrain**

Plastic pipes with holes drilled through the top that are installed on the bottom of an infiltration BMP to collect and remove excess runoff.

### **Underground Injection Control (UIC) Program**

A federal regulatory program established to protect underground sources of drinking water from UIC well discharges. In Washington, the U.S. EPA has granted Ecology authority to regulate UIC wells, except for UIC wells on tribal land.

### **Underground Injection Control (UIC) Well**

A UIC well is defined as a structure built to discharge fluids from the ground surface into the subsurface; a bored, drilled, or driven shaft whose depth is greater than the largest surface dimension; or a dug hole whose depth is greater than the largest surface dimension; or an

improved sinkhole, which is a natural crevice that has been modified; or a subsurface fluid distribution system that includes an assemblage of perforated pipes, drain tiles, or other similar mechanisms intended to distribute fluids below the surface of the ground. Examples of UIC wells or subsurface infiltration systems include drywells, drain fields, infiltration trenches with perforated pipe, storm chamber systems with the intent to infiltrate, french drains, bioretention systems intended to distribute water to the subsurface by means of perforated pipe installed below the treatment soil, and other similar devices that discharge to the ground.

## **Upgrade**

The replacement of paved areas with a better surface or in a way that enhances the traffic capacity of the road.

## **Urban road**

A roadway located inside the boundary of an Urban Growth Area.

## **Urban runoff**

Stormwater from streets and adjacent domestic or commercial properties that may carry pollutants of various kinds into storm drains or drywells and/or receiving waters.

## **USACE**

U.S. Army Corps of Engineers

## **U.S.C.**

United States Code

## **USDA**

U.S. Department of Agriculture

## **USDW**

Underground source of drinking water

## **U.S. EPA**

U.S. Environmental Protection Agency

## **USGS**

U.S. Geological Survey

## **V**

## **Variance**

See [Exception](#)

## **Vulnerability**

Vulnerability is a water source's potential for contamination. Two factors influence vulnerability:

1. **Physical susceptibility to contaminant infiltration.** Susceptibility depends on conditions that affect the movement of contaminants from the land surface into a water supply. This includes the depth of the well, its construction, the geology of the area, the pumping rate, the source(s) of groundwater recharge, and the aquifer material.

2. **The source's risk of exposure to contaminants.** The risk of exposure is measured by determining whether contaminants were used in the water supply area. However, each type of contaminant may behave differently in the environment, making it difficult to predict groundwater pollution from surface exposure accurately. For this reason, susceptibility is the key factor used in determining vulnerability. See *Washington State Wellhead Protection Program Guidance Document* ([DOH, 2010](#)).

## **W**

### **WAC**

Washington Administrative Code

### **Water body segment**

A stream reach or portion of a water body generally having the same characteristics. Water body segments may be defined by reaches between confluences with major tributaries or by section lines on a 1:24,000-scale topographical map.

### **Watershed**

The land area that drains into a stream, lake, or other body of water. An area of land that contributes runoff to one specific delivery point. Large watersheds may be composed of several smaller subwatersheds, each of which contributes runoff to different runoff locations that ultimately combine at a common delivery point or receiving water. The words *watershed* and *basin* are often used interchangeably.

### **Water quality**

A term used to describe the chemical, physical, and biological characteristics of water, usually in terms of its suitability for a particular purpose.

### **Water quality criteria**

Levels or measures of water quality considered necessary to protect a beneficial use.

### **Water quality standards**

Minimum requirements of purity of water for various uses; levels or measures of water quality considered necessary to protect a beneficial use. In Washington State, Ecology establishes water quality standards.

### **Waters of the state**

Lakes, rivers, ponds, streams, inland waters, underground waters, salt waters, and all other surface waters and watercourses within the jurisdiction of the state of Washington.

### **Water table**

The upper surface or top of the saturated portion of the soil or bedrock layer, indicating the uppermost extent of ground water.

### **WDFW**

Washington State Department of Fish and Wildlife

### **Weir**

Device for measuring or regulating the flow of water.



**Wellhead protection area**

The area surrounding a drinking water source that is focused on protection from potential contamination that typically includes four or five zones: a sanitary control area, Zone 1 (1-year travel time), Zone 2 (5-year travel time, Zone 3 (10-year travel time), and an additional buffer zone (if warranted) ([WAC 246-290-130](#) and [WAC 246-290-135](#)).

**Wetlands**

Areas characterized by saturated or nearly saturated soils most of the year that form an interface between terrestrial (land-based) and aquatic environments. Wetlands include marshes around lakes or ponds and along river or stream channels.

**Wetponds and wetvaults**

Drainage facilities for water quality treatment that contain permanent pools of water that are filled during the initial runoff from a storm event. They are designed to optimize water quality by providing retention time in order to settle out particles of fine sediment to which pollutants such as heavy metals adsorb, and to allow biologic activity that metabolizes nutrients and organic pollutants.

**Wetpool**

A pond or constructed wetland that stores runoff temporarily and whose normal discharge location is elevated to maintain a permanent pool of water between storm events.

**WISHA**

Washington Industrial Safety and Health Act

**WSDOT**

Washington State Department of Transportation

**WTR**

Water treatment residual

*This page has been intentionally left blank for double-sided printing.*

## References

### **(AASHTO, 2011)**

AASHTO (American Association of State Highway and Transportation Officials). 2011. *Highway Policy on Geometric Design of Highways and Streets* (6th Ed.).

### **(Adams, 2003)**

Adams, M.C. 2003. "Porous Asphalt Pavement with Recharge Beds: 20 Years and Still Working." *Stormwater: The Journal for Surface Water Quality Professionals*. No. 4(2).

### **(API, 1990)**

American Petroleum Institute (API). 1990. *Design and Operation of Oil-Water Separators*. Publication 421. February 1990.

### **(Appleyard, 1993)**

Appleyard, S.J. 1993. "Impact of the Stormwater Infiltration Basins on Groundwater Quality, Perth Metropolitan Region, Western Australia." *Environmental Geology* 21(4): 227–236.

### **(ASCE,1992)**

ASCE (American Society of Civil Engineers). 1992. "Design and Construction of Urban Stormwater Management Systems." *ASCE Manuals and Reports of Engineering Practice* No. 77. ASCE. New York, NY.

### **(ASCE and WEF, 1998)**

ASCE and WEF (American Society of Civil Engineers and Water Environment Federation). 1998. *Urban Runoff Quality Management* No. 23. 1998.

### **(ASLA, 2010)**

ASLA (American Society of Landscape Architects). 2010. "The Great Soil Debate Part II: Structural Soils Under Pavement." Annual Meeting, American Society of Landscape Architects (ASLA). September 11, 2010.

### **(Avolio, 2003)**

Avolio, C.M. 2003. *The Local Impacts of Road Crossings on Puget Lowland Creeks*. University of Washington.

### **(AWWA, 1999)**

AWWA (American Water Works Association). 1999. *Residential End Uses of Water*. American Water Works Association Research Foundation.

### **(AWWA, 1999b)**

AWWA (American Water Works Association). 1999b. C651-99: *AWWA Standard for Disinfecting Water Mains*. Denver, CO.

### **(AWWA, 2002)**

AWWA (American Water Works Association). 2002. C652-11: *AWWA Standard for Disinfecting*

*Water Storage Facilities*. Denver, CO.

**(Azous and Horner, 2000)**

Azous, A.L. and R.R. Horner, eds. 2000. *Wetlands and Urbanization: Implications for the Future*. CRC Press, Boca Raton, FL.

**(Bannerman et al., 1993)**

Bannerman, R.T., D.W. Owens, R.B. Dodds, and N.J. Hornewer. 1993. "Sources of Pollutants in Wisconsin Stormwater." *Water Science & Technology* 28: 241–259.

**(Balousek, 2003)**

Balousek, J.D. 2003. *Quantifying Decreases in Stormwater Runoff from Deep Tilling, Chisel Plowing, and Compost-Amendment*. Dane County Conservation Department.

**(Bartens et al., 2009)**

Bartens, J., S.D. Day, J.R. Harris, T.M. Wynn, and J.E. Dove. 2009. "Transpiration and Root Development of Urban Trees in Structural Soil Stormwater Reservoirs." *Environmental Management*. No. 44, 646–657.

**(Bassuk et al., 2005)**

Bassuk, N., J. Grabosky, and P. Trowbridge. 2005. *Using CU-Structural Soil™ in the Urban Environment*. Cornell University Urban Horticulture Institute.

**(Bledsoe and Watson, 2001)**

Bledsoe, B.P. and C.C. Watson. 2001. "Effects of Urbanization on Channel Instability." *Water Pollution Control Federation Journal* 45 (5): 850–869.

**(Bohnhoff, 2001)**

Bohnhoff, B. 2001. *Bill Bohnhoff's White Papers*. Golden, CO: Invisible Structures, Inc.

**(Booth, 1991)**

Booth, D.B. 1991. "Urbanization and the Natural Drainage System – Impacts, Solutions and Prognoses." *The Northwest Environmental Journal*. University of Washington. 7:93–118.

**(Booth, 1997)**

Booth, D.B. 1997. *Rationale for a 'Threshold of Concern' in Stormwater Release Rates*. Center for Urban Water Resources Management, Department of Civil Engineering, University of Washington. 8 pp.

**(Booth et al., 2002)**

Booth, D.B., D. Hartley, and R. Jackson. 2002. "Forest Cover, Impervious-Surface Area, and the Mitigation of Stormwater Impacts." *Journal of the American Water Resources Association* 38(3): 835-846.

**(Buckman and Brady, 1969)**

Buckman, H.O., and N.C. Brady. 1969. *The Nature and Properties of Soils*. Collier Macmillan Ltd. Toronto, ON.

**(Cahill et al., 2003)**

Cahill, T.H., M. Adams, and C. Marm. 2003. *Porous Asphalt: The Right Choice for Porous Pavements*. Hot Mix Asphalt Technology.

**(CMHC, 2007)**

Canadian Mortgage and Housing Corporation (CMHC). 2007. "Residential Street Pattern Design." Research Highlights: Socio-Economic Series. No. 75. Ottawa, ON.

**(Cappuccitti and Page, 2000)**

Cappuccitti, D.J. and W.E. Page. 2000. *Stream Response to Stormwater Management Best Management Practices in Maryland*. Section 319(h) Clean Water Act Report submitted by the Maryland Department of the Environment to U.S. Environmental Protection Agency.

**(Caraco, 2000)**

Caraco, D. 2000. "Stormwater Strategies for Arid and Semi-Arid Watersheds." *Watershed Protection Techniques* 3(3). March 2000.

**(CWP, 1998)**

Center for Watershed Protection (CWP). 1998. *Costs and Benefits of Stormwater BMPs: Final Report*. September 14, 1998.

**(Chang, 2000)**

Chang, G.C. 2000. *Review of Stormwater Manual-Sand Filtration Basins for Department of Ecology, State of Washington*. November 5, 2000.

**(Chow, 1964)**

Chow, V.T. 1964. Section 8, "Frequency Analysis." *Handbook of Applied Hydrology*. McGraw Hill.

**(Chollak, n.d.)**

Chollak, T. n.d. "Guidelines for Landscaping with Compost-Amended Soils." *CH2M Hill Soil Improvement Project: Exploring the Alternatives*. Snohomish County Public Works Solid Waste Division.

**(City of Austin, 1988)**

City of Austin. 1988. "Design Guidelines for Water Quality Control Basins." *Environmental Criteria Manual*. Austin, TX. June 1988.

**(City of San José, 2004)**

City of San José. 2004. *Is Your Roof Runoff Polluted?* Environmental Services Department, San José, CA. March 2004.

**(Colandini et al., 1995)**

Colandini, V., M. Legret, Y. Brosseau, and J. Baladès. 1995. "Metallic Pollution in Clogging Materials of Urban Porous Pavements." *Water Science & Technology*. 32(1), 57–62.

**(Cowherd et al., 1988)**

Cowherd, C., G.E. Muleski, and J.S. Kinsey. 1988. *Control of Open Fugitive Dust Sources. Final*

Report. EPA-450/3-88-088. Prepared for the U.S. Environmental Protection Agency Office of Air Quality Planning and Standards. Research Triangle Park, NC. September 1988.

**(CWP, 1997)**

CWP (Center for Watershed Protection). 1997. *Stormwater BMP Design Supplement for Cold Climates*. Ellicott City, MD. December 1997.

**(Daar, 1992)**

Daar, S. 1992. *Least Toxic Pest Management for Lawns*. Integral Resource Center, Berkeley, CA.

**(Davis et al., 1998)**

Davis, A.P., M. Shokouhian, H. Sharma, and C. Minami. 1998. *Optimization of Bioretention Design for Water Quality and Hydrologic Characteristics. Final Report*. (Project No. 01-4-31032). Landover, MD: The Prince George's County Government, Department of Environmental Resources.

**(Day and Dickinson, 2008)**

Day, S.D. and S.B. Dickinson. 2008. *Managing Stormwater for Urban Sustainability Using Trees and Structural Soils*. Virginia Polytechnic Institute and State University.

**(Diniz, 1980)**

Diniz, E.V. 1980. *Porous Pavement: Phase I – Design and Operational Criteria*. EPA – 600/2-80-135. Prepared by the United States Environmental Protection Agency (U.S. EPA).

**(DOH, 2009)**

DOH (Washington State Department of Health). 2009. *Water System Design Manual*. Publication Number 331-123. Office of Drinking Water. December 2009.

**(DOH, 2010)**

DOH (Washington State Department of Health). 2010. *Washington State Wellhead Protection Program Guidance Document*. June 2010.

**(Dunnett and Kingsbury, 2008)**

Dunnett, N. and N. Kingsbury. 2008. *Planting Green Roofs and Living Walls*. Timber Press.

**(Ecology, 1993)**

Ecology (Washington State Department of Ecology). 1993. *Dam Safety Guidelines, Technical Note 3, Design Storm Construction*. Report 92-55G. Water Resources Program, Dam Safety Office. April 1993.

**(Ecology, 1993b)**

Ecology (Washington State Department of Ecology). 1993b. *Restoring Wetlands in Washington*, Pub. #93-17.

**(Ecology, 2003)**

Washington State Department of Ecology (Ecology). 2003. *Step By Step Fact Sheet for Hazardous*

*Waste Generators*. Publication No. 91-12. Revised May 2003.

**(Ecology, 2008)**

Washington State Department of Ecology (Ecology). 2008. *Suggested Practices to Reduce Zinc Concentrations in Industrial Stormwater Discharges*, Publication Number 08-10-025. Water Quality Program. June 2008.

**(Ecology, 2011)**

Ecology (Washington State Department of Ecology). 2011. *Vehicle and Metal Recyclers: A Guide for Implementing the Industrial Stormwater General National Pollutant Discharge Elimination System Permit Requirements*. Publication Number 94-146. Water Quality Program. Revised March 2011.

**(Ecology, 2012)**

Ecology (Washington State Department of Ecology). 2012. *Vehicle and Equipment Washwater Discharges/Best Management Practices Manual*. Publication Number WQ-95-056. Water Quality Program. Revised November 2012.

**(Ecology, 2013)**

Ecology (Washington State Department of Ecology). 2013. *Focus on Emergency Spill Response*. Publication Number 97-1165-CP. Spill Prevention, Preparedness, and Response Program. Revised August 2013.

**(Ecology, 2014)**

Ecology (Washington State Department of Ecology). 2014. *Washington State Wetland Rating System for Eastern Washington*. Ecology Publication Number 14-06-030.

**(Ecology, 2016)**

Ecology (Washington State Department of Ecology). 2016. *Focus on Bioretention Soil Media*. Publication Number 13-10-017. Revised May 2016.

**(Ecology, 2016b)**

Ecology (Washington State Department of Ecology). 2016b. *Industrial Stormwater General Permit Implementation Manual for Log Yards*. Publication Number 04-10-031. Revised December 2016.

**(Ecology, 2016c)**

Ecology (Washington State Department of Ecology). 2016c. *Methods for Dust Control*. Publication Number 96-433. Revised July 2016.

**(FCPA, n.d.)**

FCPA (Florida Concrete and Products Association, Inc.). N.d. *Construction of Portland Cement Pervious Pavement*.

**(FDACS, 2014)**

FDACS (Florida Department of Agriculture and Consumer Services). 2014. *Water Quality/Quantity Best Management Practices for Florida Nurseries*. DACS-P-1267. April 2014.

**(Ferguson, 2005)**

Ferguson, B.K. 2005. *Porous Pavements: Integrative Studies in Water Management and Land Development*.

**(FHWA, 1989)**

FHWA (Federal Highway Administration). 1989. *Design of Riprap Revetment*. Hydraulic Engineering Circular No. 11. U.S. Department of Transportation, Federal Highway Administration, National Highway Institute (NHI), FHWA-IP-89-016.

**(FHWA, 1998)**

FHWA (Federal Highway Administration). 1998. *Geosynthetic Design and Construction Guidelines*. Participant Notebook. FHWA-HI-95-038. U.S. Department of Transportation, Federal Highway Administration, National Highway Institute (NHI). Revised April 1998.

**(FHWA, 2006)**

FHWA (Federal Highway Administration). 2006. *Hydraulic Design of Energy Dissipators for Culverts and Channels*. Hydraulic Engineering Circular No. 14. Third Edition. FHWA-NHI-06-086. U.S. Department of Transportation, Federal Highway Administration, National Highway Institute (NHI). July 2006.

**(Field et al., 1997)**

Field, R., R.E. Pitt, C-Y Fan, J.P. Heaney, M.K. Stinson, R.N. DeGuida, J.M. Perdek, M. Borst, and K.F. Hsu. 1997. "Urban Wet-Weather Flows." *Water Environment Research Literature Review*.

**(Frederick et al., 1981)**

Frederick R.H., F.P. Richards, and R.W. Schwerdt. 1981. *Interduration Precipitation Relations for Storms - Western United States*. NOAA Technical Memorandum NWS 27. U.S. Department of Commerce, National Oceanic and Atmospheric Administration, National Weather Service, Washington, D.C.

**(Gaus, 1994)**

Gaus, J. 1994. *High Use/Oil Control Decision Paper-Second Draft*. King County Surface Water Management.

**(Grabosky and Gilman, 2004)**

Grabosky, J. and E.F. Gilman. 2004. "Measurement and Prediction of Tree Growth Reduction From Tree Planting Space Design in Established Parking Lots." *Journal of Arboriculture*. No. 30, 154–159.

**(Haffner et al., 2007)**

Haffner, T., N. Bassuk, J. Grabosky, and P. Trowbridge. 2007. *Using Porous Asphalt and CU-Structural Soil™*. Cornell University Urban Horticulture Institute.

**(Hajda et al., 1999)**

Hajda, P., V. Novotny, and A. Bartosova. 1999. *Estimating the Effect of Urbanization on the*



*Discharge-Frequency Relationship*. Technical Report No. 4. Milwaukee: Institute for Urban Environmental Risk Management, Marquette University.

**(Hammer, 1972)**

Hammer, T.R. 1972. "Stream Channel Enlargement Due to Urbanization." *Water Resources Research*8(6).

**(Harvey and Watson, 1986)**

Harvey, D.E. and C.C. Watson. 1986. "Fluvial Processes and Morphological Thresholds in Incised Channel Restoration." *Water Resources Bulletin*22(3).

**(Haver, 2014)**

Haver, D. 2014. *Best Management Practices: A Water Quality Field Guide for Nurseries*. Southern California Edition. The Regents of the University of California, 2014.

**(Herrera, 2011)**

Herrera (Herrera Environmental Consultants). 2011. *Prioritizing Revisions to the Existing TAPE Guidance Document*. Prepared for the Washington Stormwater Center. January 13, 2011.

**(Hinman, 2009)**

Hinman, C. 2009. *Bioretention Soil Mix Review and Recommendations for Western Washington*. Washington State University Extension.

**(Hitchcock and Cronquist, 1973)**

Hitchcock, C.L. and A. Cronquist. 1973. *Flora of the Pacific Northwest*. University of Washington Press, Seattle, WA.

**(Hollis, 1975)**

Hollis, G.E. 1975. "The Effect of Urbanization on Floods of Different Recurrence Intervals." *Water Resources Research* 11(3).

**(Hortus Northwest, 1993)**

Hortus Northwest. 1993. *Wetland Plants for Western Oregon*, Issue 4.

**(Hossain et al., 1992)**

Hossain, M., L.A. Scofield, and W.R. Meier Jr. 1992. *Porous Pavement for Control of Highway Runoff in Arizona: Performance to Date*. Transportation Research Record. No. 1354, 45–54.

**(ICC, 2003)**

ICC (International Code Council). 2003. ICC/ANSI A17.1-2003: *Accessible and Usable Buildings and Facilities*.

**(ICC, 2012)**

ICC (International Code Council). 2012. IFC 503.2: *Fire Apparatus Access Roads*. 2012 International Fire Code.

**(Ingloria et al., 1997)**

Ingloria, R.V., W.E. Hawthorn, and D.R. Yonge. 1997. "Native Organic Matter and Trace Metal Attenuation during Stormwater Infiltration." *Journal of Hydrologic Engineering* 2(3): 120–128.

**(Invisible Structures, 2003)**

Invisible Structures, Inc. 2003. *Technical Specification – Gravelpave2 Porous Paving with Integrated Geotextile Fabric and Anchors*. Golden, CO.

**(Jaisinghani and Sprenger, 1979)**

Jaisinghani, R.A. and G.S. Sprenger. 1979. "A Study of Oil/Water Separation in Corrugated Plate Separators." *Journal of Engineering for Industry*. November 1979.

**(Kim et al., 2003)**

Kim, H., E.A. Seagren, and A.P. Davis. 2003. "Engineered Bioretention for Removal of Nitrate from Stormwater Runoff." *Water Environment Research*. No. 75, 355–367.

**(King County, 2016)**

King County. 2016. *King County Surface Water Design Manual*. April 24, 2016.

**(Koob et al., 1999)**

Koob, T., M.E. Barber, and W.E. Hathhorn. 1999. "Hydrologic Design Considerations of Constructed Wetlands for Stormwater Runoff." *Journal of the American Water Resources Association* 35(2): 323–331.

**(Kulash, 2001)**

Kulash, W.M. 2001. *Residential Streets*. 3rd ed. National Association of Home Builders (NAHB), American Society of Civil Engineers (ASCE), Institute of Transportation Engineers (ITE), and Urban Land Institute, New York, NY.

**(Kulzer, 1997)**

Kulzer, L. 1997. "Stormwater Quality Control." *Urban Stream Protection, Restoration, and Stewardship in the Pacific Northwest, Are We Achieving Desired Results?*, Workshop Proceedings. Douglas College, New Westminster, B.C. March 10–12, 1997.

**(Lindsay and Bussuk, 1992)**

Lindsey, P. and N. Bussuk. 1992. "Redesigning the Urban Forest from the Ground Below: A New Approach to Specifying Adequate Soil Volumes for Street Trees." *Arboricultural Journal*. No. 16, 25–39.

**(Leopold et al., 1964)**

Leopold, L.B., M.G. Wolman, and J.P. Miller. 1964. *Fluvial Processes in Geomorphology*, San Francisco, CA. WH Freeman Co. 511 pp.

### **(Low Impact Development Center, 2012)**

Low Impact Development Center. 2012. *LID Integrated Management Practices (IMP) Standards and Specifications*.

### **(Lucas and Greenway, 2009)**

Lucas, W.C. and M. Greenway. 2009. "Trends in Nutrient Retention by Bioretention Systems: Long-Term Response to Varied Nutrient Loads." 6th International Water Sensitive Urban Design & Hydropolis.

### **(Marsalek, 1991)**

Marsalek, J. 1991. "*Urban Drainage in Cold Climates: Problems, Solutions and Research Needs.*" *New Technologies in Urban Drainage*. Elsevier Applied Science. New York, NY.

### **(Marshall, 2016)**

Marshall, R. 2016. *Whole Effluent Toxicity Testing Guidance and Test Review Criteria*. Department of Ecology Publication WQ-R-95-80. June 2016.

### **(Mason et al., 1999)**

Mason, Y., A.A. Ammann, A. Ulrich, and L. Sigg. 1999. "Behavior of Heavy Metals, Nutrients, and Major Components during Roof Runoff Infiltration." *Environmental Science and Technology* 33 (10): 1588–1597.

### **(Massmann, 2008)**

Massmann, J. 2008. *Infiltration Pond Research Extension Final Report*. Prepared for the Washington State Department of Transportation by Keta Waters LLC, Mercer Island, WA. August 2008.

### **(May et al., 1997)**

May, C.W., R.R. Horner, J.R. Karr, B.W. Mar, and E.B. Welch. 1997. *The Cumulative Effects of Urbanization on Small Streams in the Puget Sound Lowland Ecoregion*. University of Washington.

### **(McPherson et al., 2005)**

McPherson, E.G, J.R. Simpson, P.J. Peper, S.E. Maco, S.L. Gardner, S.K. Cozad, and Q. Xiao. 2005. *City of Minneapolis, Minnesota Municipal Tree Resource Analysis*. Technical Report to Forestry Section. Minneapolis Parks and Recreation Board.

### **(Mikkelsen et al., 1996a)**

Mikkelsen, P.S., M. Haefliger, M. Ochs, P. Jacobsen, J.C. Tjell, and M. Boller. 1996. "Pollution of Soil and Groundwater from Infiltration of Highly Contaminated Stormwater – A Case Study." *Water Science and Technology* 36 (8-9): 325–330.

### **(Mikkelsen et al., 1996b)**

Mikkelsen, P.S., M. Haefliger, M. Ochs, J.C. Tjell, P. Jacobsen, and M. Boller. 1996. "Experimental Assessment of Soil and Groundwater Contamination from Two Old Infiltration Systems for Road Run-Off in Switzerland." *Science of the Total Environment* 189–190, pp. 341–347.

**(Miller et al., 1973)**

Miller, J.F., R.H. Frederick and R.S. Tracey. 1973. *NOAA Atlas 2, Precipitation-Frequency Atlas of the Western United States, Volume IX – Washington*. U.S. Dept. of Commerce, National Oceanic and Atmospheric Administration (NOAA), and National Weather Service. Washington, D.C.

**(Miller, 2000)**

Miller, S. 2000. *Criteria for Assessing the Trace Element Removal Capacity of Bio-filtration Systems*. Spokane County. June 2000.

**(NAPA, 2008)**

NAPA (National Asphalt Pavement Association). 2008. *Porous Asphalt Pavements for Stormwater Management: Design, Construction, and Maintenance Guide*. November 2008.

**(National Weather Service, 1994)**

National Weather Service. 1994. *Probable Maximum Precipitation for the Pacific Northwest States - Columbia, Snake River, and Pacific Coastal Drainages*. Hydrometeorological Report No. 57. U.S. Department of Commerce, National Oceanic and Atmospheric Administration, Silver Spring, MD. October 1994.

**(NCHRP, 1994)**

NCHRP (National Cooperative Highway Research Program). 1994. *Long-Term Performance of Geosynthetics in Drainage Applications*. NCHRP Report 367. November 1994.

**(NFPA, 2018)**

NFPA (National Fire Protection Association). 2018. *NFPA 30A: Code for Motor Fuel Dispensing Facilities and Repair Garages*.

**(NOAA, 1983)**

NOAA (National Oceanic and Atmospheric Administration). 1983. *Water Available for Runoff for 1 to 15 Days Duration and Return Periods of 2 to 100 Years for Selected Agricultural Regions in the Northwest United States*. NOAA Technical Report NWS 36. U.S. Dept. of Commerce, National Oceanic and Atmospheric Administration (NOAA), and National Weather Service, April 1983.

**(Parrett, 1998)**

Parrett C. 1998. *Characteristics of Extreme Storms in Montana and Methods for Constructing Synthetic Storm Hyetographs*. Water Resources Investigations Report 98-4100. U.S. Geological Survey, Helena, MT. July 1998.

**(Pentec Environmental, 2000)**

Pentec Environmental. 2000. *BMP – Permeable Interlocking Concrete Pavement*. (Project No. 503-001). Prepared for Mutual Materials.

**(Pitt et al., 1999)**

Pitt, R., S. Clark, and R. Field. 1999. "Groundwater Contamination Potential from Stormwater

Infiltration Practices.” *Urban Water* 1(3): 217–236.

**(Pitt et al., 1995)**

Pitt R., R. Clark, and J. Voorhies. 1995. *Water Removal in Bioretention Devices by Evapotranspiration Processes and Related Issues Affecting Performance*.

**(Pope and Hess, 1989)**

Pope, L.M. and L.G. Hess. 1989. “Load-Detention Efficiencies in a Dry-Pond Basin.” *Design of Urban Runoff Quality Controls*. Edited by Roesner, Urbonas and Sonnen. ASCE. New York, NY.

**(Prichard et al., 1998)**

Prichard, D., J. Anderson, C. Correll, J. Fogg, K. Gebhardt, R. Krapf, S. Leonard, B. Mitchell, and J. Staats. 1998. *Riparian Area Management TR-1737-15: A User Guide to Assessing Proper Function Condition and the Supporting Science for Lotic Areas*. BLM/RS/ST-98/001+173). U.S. Department of the Interior, Bureau of Land Management.

**(Prince George's County, 2007)**

Prince George's County. 2007. *Bioretention Manual*. Environmental Services Division of the Department of Environmental Resources, The Prince George's County, MD. Revised December 2007.

**(Pscheidt and Ocamb, 2016)**

Pscheidt, J.W. and C.M. Ocamb, eds. 2016. *Pacific Northwest Plant Disease Management Handbook*. Oregon State University. Available at: <http://pnwhandbooks.org/plantdisease>.

**(Retzlaff, 2006)**

Retzlaff, B. 2006. *The G.R.E.E.N. Research Report*. Green Roof Environmental Evaluation Network.

**(Romano, 1990)**

Romano, F. 1990. *Oil and Water Don't Mix: The Application of Oil-Water Separation Technologies in Stormwater Quality Management*. Municipality of Metropolitan Seattle. October 1990.

**(Sartor and Boyd, 1972)**

Sartor, J.D. and B.G. Boyd. 1972. *Water Pollution Aspects of Street Surface Contaminants*. EPA-R2-72-081. November 1972. p. 7.

**(Schaefer, 1989)**

Schaefer, M.G. 1989. *Characteristics of Extreme Precipitation Events in Washington State*. Report 89-51. Washington State Department of Ecology, Water Resources Program. October 1989.

**(Schueler, 1992)**

Schueler, T.R. 1992. “Water Quality inlets/Oil Grit Separators.” BMP Fact Sheet #11, Current Assessment of Urban Best Management Practices. March 1992.

**(Schueler, 1995)**

Schueler, T.R. 1995. *Site Planning for Urban Stream Protection*. Metropolitan Washington Council of Governments, Washington, D.C.

**(Schueler and Helfrich, 1989)**

Schueler, T.R. and M. Helfrich. 1989. "Design of Extended Detention Wet Pond Systems." *Design of Urban Runoff Quality Controls*. Edited by Roesner, Urbonas, and Sonnen. ASCE. New York, NY.

**(Semkin and Jeffries, 1988)**

Semkin, R.G. and D.S. Jeffries. 1988. "Chemistry of Atmospheric Deposition, the Snowpack, and Snowmelt in the Turkey Lakes Watershed." *Canadian Journal of Fisheries and Aquatic Sciences* 45 (S1): s38–s46.

**(Smith, 2000)**

Smith, D.R. 2000. *Permeable Interlocking Concrete Pavements: Selection, Design, Construction, Maintenance*.

**(Smith, 2011)**

Smith, D.R. 2011. *Permeable Interlocking Concrete Pavements: Design, Specifications, Construction, Maintenance* (4th Ed.).

**(Sound Native Plants, 2000)**

Sound Native Plants. 2000. *Relative Success of Transplanted/Outplanted Plants*.

**(Stahre and Urbonas, 1989)**

Stahre, P. and B. Urbonas. 1989. "Swedish Approach to Infiltration and Percolation Design." *Design of Urban Runoff Quality Controls*, edited by L.A. Roesner, B. Urbonas and M.B. Sonnen. ASCE. New York, NY.

**(Strecker et al., 1997)**

Strecker, E.W., B. Wu, and M. Iannelli. 1997. *Analysis of Oregon Urban Runoff Water Quality Monitoring Data Collected from 1990 to 1996*. Prepared for the Oregon Association of Clean Water Agencies. June 1997.

**(Stuart, 2001)**

Stuart, D. 2001. *On-site Runoff Mitigation with Rooftop Rainwater Collection and Use*. King County Department of Natural Resources, Water and Land Resources Division.

**(Sunset Magazine, 2012)**

Sunset Magazine. 2012. *The New Sunset Western Garden Book: The Ultimate Gardening Guide* (9th Ed.).

**(Sutherland et al., 1998)**

Sutherland, R.C, S.L. Jelen, and G. Minton. 1998. "High Efficiency Sweeping as an Alternative to the Use of Wet Vaults for Stormwater Treatment." *Advances in Modeling the Management of Stormwater Impacts*. Vol. 6. Edited by W. James. Pp. 351–372. Computational Hydraulics International, Guelph, ON.

**(Texas Water Development Board, 1997)**

Texas Water Development Board. 1997. *Texas Guide to Rainwater Harvesting* (2nd Ed.).

**(Texas Water Development Board, 2005)**

Texas Water Development Board. 2005. *The Texas Manual on Rainwater Harvesting* (3rd Ed.).

**(Thompson, 2001)**

Thompson, W.H. 2001. *Test Methods for the Examination of Composting and Compost*. US Composting Council Research and Education Foundation and United States Department of Agriculture.

**(University of Florida, 2008)**

University of Florida. 2008. *Florida Field Guide to Low Impact Development*. Program for Resource Efficient Communities.

**(UNHSC, 2009)**

University of New Hampshire Stormwater Center (UNHSC). 2009. *University of New Hampshire Stormwater Center 2009 Annual Report*.

**(Urban, 2008)**

Urban, J. 2008. *Up by Roots: Healthy Soils and Trees in the Built Environment*. International Society of Arboriculture.

**(Urbonas, 1997)**

Urbonas, B. 1997. *An Assessment of Stormwater BMP Technology*. Technical Report. Vol. 1. U.S. Environmental Protection Agency, Office of Research Development, Cincinnati, OH.

**(USACE, 1987)**

U.S. Army Corps of Engineers (USACE). 1987. *Wetland Delineation Manual*. Technical Report Y-87-1.

**(USACE, 1994)**

U.S. Army Corps of Engineers (USACE). 1994. *Selection and Design of Oil/Water Separators at Army Facilities*. August 26, 1994.

**(USACE, 1998)**

U.S. Army Corps of Engineers (USACE). 1998. *Engineering and Design Manual: Runoff from Snowmelt*. No. 1110-2-1406. March 31, 1998.

**(USACE, 2003)**

U.S. Army Corps of Engineers (USACE). 2003. Section 02726, "Portland Cement Pervious Pavement." *Whole Barracks Renewal*. Fort Lewis, WA (02022/DB-CS).

**(USAF, 1991)**

U.S. Air Force (USAF). 1991. *Gravity Oil and Water Separator Design Criteria*.

**(USBR, 1993)**

U.S. Bureau of Reclamations (USBR). 1993. *Drainage Manual*. U.S. Department of the Interior.

**(U.S. Census Bureau, 2017)**

U.S. Census Bureau. 2017. *North American Industry Classification System*. Executive Office of the President, Office of Management and Budget.

**(USDA, 1986)**

U.S. Department of Agriculture (USDA) 1986. *Urban Hydrology for Small Watersheds, Technical Release 55*. Natural Resources Conservation Service. Conservation Engineering Division. June 1986.

**(USDA, 2004)**

USDA (U.S. Department of Agriculture). 2004. *Chapter 9, "Hydrologic Soil-Cover Complexes" and Chapter 10, "Estimation of Direct Runoff from Storm Rainfall."* *National Engineering Handbook, Part 630 Hydrology*. 210-VI-NEH. Natural Resources Conservation Service. July 2004.

**(USDA and USCC, 2005)**

USDA and USCC (U.S. Department of Agriculture and U.S. Composting Council). 2005. "TMECC 05.07A Loss-On-Ignition Organic Matter Method." *Test Methods for the Examination of Composting and Compost (TMECC)*.

**(U.S. EPA, 1992)**

U.S. EPA (U.S. Environmental Protection Agency). 1992. *Fugitive Dust Background Document and Technical Information Document for Best Available Control Measures*. EPA-450/2-92-004. Office of Air and Radiation/Office of Air Quality Planning and Standards. September 1992.

**(U.S. EPA, 1995)**

U.S. EPA (U.S. Environmental Protection Agency). 1995. Federal Register Notice: *Final National Pollutant Discharge Elimination System Storm Water Multi-Sector General Permit for Industrial Activities* 60(189). September 1995.

**(U.S. EPA, 1999)**

U.S. EPA (U.S. Environmental Protection Agency). 1999. *The Class V Underground Injection Control Study*. EPA/816-R-99-014.

**(U.S. EPA, 2008)**

U.S. Environmental Protection Agency (U.S. EPA). 2008. *Clarification on Which Stormwater Infiltration Practices/Technologies Have the Potential to Be Regulated as "Class V" Wells by the Underground Injection Control Program*. June 2008.

**(U.S. EPA, 2013)**

U.S. Environmental Protection Agency (U.S. EPA). 2013. *National Pollutant Discharge Elimination System (NPDES): Bioretention (Rain Gardens)*.

**(Water Pollution Control Federation, 1985)**

Water Pollution Control Federation. 1985. *Clarifier Design*. Manual of Practice Number FD-8. 1985.



### **(Watershed Protection Techniques, 1994)**

Watershed Protection Techniques. 1994. "Hydrocarbon Hotspots in the Urban Landscape: Can They be Controlled?" February 1994.

### **(WDFW, 2002)**

WDFW (Washington Department of Fish and Wildlife). 2002. *Integrated Streambank Protection Guidelines*. Washington State Aquatic Habitat Guidelines Program.

### **(Wei, 1986)**

Wei, Irvine W. 1986. *Installation and Evaluation of Permeable Pavement at Walden Pond State Reservation*. Final Report to the Commonwealth of Massachusetts, Division of Water Pollution Control (Research Project 7-12 & 80-22). Northeastern University.

### **(Williams, 1978)**

Williams, G.P. 1978. "Bankfull Discharge of Rivers." *Water Resources Research* 14(6): 1141–1153.

### **(Woodward-Clyde, 1995)**

Woodward-Clyde. 1995. "Oil/Water Separators." *BMP Design Recommendations*. November 1995.

### **(WSDOT, 2003)**

WSDOT (Washington State Department of Transportation). 2003. *Low Impact Development (LID) Project: Permeable Surfaces* (WSDOT Permeable Pavement Specs 10-03.doc).

### **(WSDOT, 2005)**

WSDOT (Washington State Department of Transportation). 2005. *Application of a Simplified Analysis Method for Natural Dispersion of Highway Stormwater Runoff*. WA-RD 618.1 Research Report. Prepared for the WSDOT Research Office (WARD) by M. Reister and D. Younge. August 2005.

### **(WSDOT, 2011)**

WSDOT (Washington State Department of Transportation). 2011. *Eastern Washington Steep Slope Research for Management of Highway Stormwater*. WA-RD 77.1 Research Report. Prepared for the WSDOT Research Office (WARD) by A. Navickis-Brasch. May 2011.

### **(WSDOT, 2015)**

WSDOT (Washington State Department of Transportation). 2015. *WSDOT NPDES Municipal Stormwater Permit Final Highway Runoff Characterization Report (S7.B) Water Years 2012–2014*. October 2015.

### **(WSDOT, 2017)**

WSDOT (Washington State Department of Transportation). 2017. *Hydraulics Manual*. March 2017.

### **(WSDOT, 2017b)**

WSDOT (Washington State Department of Transportation). 2017. *Stormwater Infiltration in Highway Embankments – Saturated Hydraulic Conductivity Estimation for Uncompacted and Compacted Soils*. WA-RD 872.1 Research Report. Prepared for the WSDOT Research Office by T.M. Allen. October 2017.

**(WSU - PSP, 2012)**

WSU-PSP (Washington State University-Puget Sound Partnership). 2012. *Low Impact Development Technical Guidance Manual for Puget Sound*. December 2012.